





**Sensors for
Factory Automation**

Short Form

	Page		Page
IO-Link Sensors	6	Laser Sensors	64
IO-Link. DP-100L · HG-C1000L · FX-550L	6	EX-L200	64
GX-300	8	LS-400	66
Photoelectric Sensors / Standard Sensors	12	LS-500	68
CX-400	12	Safety Sensors	70
NX5	16	SF4D	70
CY-100	18	SF4B (V2)	73
Photoelectric Sensors / Miniature Sensors	20	SF4B-C	76
EX-Z	20	SF4C	78
EX-10	22	SF2B/SF2C	80
EX-20	24	SG-P 	82
EX-30	26	ST4	84
PM-25/45/65	28	SF-C21	86
PM2	31	SF-C10	87
Photoelectric Sensors / Trigonometric Sensors	33	Pressure & Flow Sensors	88
EQ-500	33	DP-0	88
EQ-30	35	DP-100	90
Photoelectric Sensors / AREA Sensors	36	DPC-100/	
NA1-11	36	DPH-100	92
NA1-PK5/ NA1-PK3	38	DPC-L100 / DPH-L100	94
Fiber-optic Sensors	40	FM-200	96
FX-100	40	Inductive Proximity Sensors	98
FX-301	42	GX-300 	98
FX-311	44	GX-M	102
FX-500/550	45	GX-F/H	104
Standard Fibers	48	Measurement Sensors	106
Fibers with integrated high-precision plug	48	HG-S	106
Threaded fibers	50	HG-C	108
Square head fibers	51	HL-G1	110
Cylindrical fibers	52	HL-C2	112
Fibers with sleeve	53	HG-T	114
Flat fibers	54	GP-X	116
Wide beam fibers	55	Ionizers/Electrostatic Sensors	118
Convergent reflective fibers for glass detection	56	ER-Q	118
Heat-resistant fibers	57	ER-F	119
Chemical-resistant fibers	58	ER-X	121
Vacuum-resistant fibers	58	ER-VW	123
Fibers for liquid leak/liquid detection	59	ER-V	125
Lens	60	EC-G	127
Fiber sensors Communication Units	61	EF-S1	128
Communication units	61	Accessories	129
Mark Sensors	62		
LX-100	62		



Anwendungsbeispiele:



Electronics



Automotive



Woodworking industry



Packaging industry



Glass/Wafer production



People counting



Electronic part discharging

Everything from a single source

With over 100 years of innovation and manufacturing expertise, Panasonic Industry Europe remains committed to its vision of creating “A Better Life, A Better World.” Panasonic can look back on decades of experience in the electronics industry and, thanks to its dedicated customer orientation, is a competent and reliable partner for customers throughout Europe when it comes to technical expertise in combination with solution orientation. As a provider of tailor-made solutions, we focus on offering our customers products and services in the Mobility, Living Space and Business sectors that make a difference thanks to our proprietary innovations.

Smart automation technology

The factory of the future will achieve new levels of productivity, effectiveness and profitability through comprehensive networking. Equipment and components from Panasonic Industry Europe offer leading-edge **Industry 4.0** features, as connectivity, energy efficiency, reliability and sturdiness play a pivotal role in modern production environments.

The Panasonic Industry Europe portfolio not only offers key electronic components, devices, modules and software but also complete solutions for production lines in a wide variety of industries. Panasonic Industry's comprehensive know-how along the entire value chain, combined with a corporate culture geared to customer needs, enables it to offer customer-specific solutions that extend beyond the products.

Our experience as a manufacturer and a sales partner for components and products allows us to share our experience with our customers. Customer wishes are specifically integrated into the development of new products, so that we can surpass our role as a supplier and become a competent, long-term partner for our customers.

A new performance class of innovative sensor technology

Over the past ten years, Panasonic has developed a wide range of high-quality sensors that fit into our portfolio of a provider of complete solutions for factory automation. Besides through-beam and retroreflective types, reflective sensors and optical fiber photoelectric sensors, we also offer laser and eddy current and contact analog sensors that provide precise measurement results even in the most complicated of applications.

Our delivery program also includes safety sensors, photoelectric sensors for special applications, inductive proximity switches and miniature pressure sensors for relative or differential pressure measurement, and ionizers for Electro Static Discharge (ESD) applications. Of course, we adapt our sensors to your individual requirements in order to ensure optimal functionality and efficiency.



Service

In addition to an expert hotline, the extensive service from Panasonic Industry Europe also includes workshops and on-site service to ensure that our sensors are used reliably and effectively.

Apart from the broad product portfolio of sensors, Panasonic Industry Europe also offers programmable logic controllers, touch terminals, drive technology, energy management systems, ionizers, automation components and many other products and complete solutions.



IO-Link

DP-100L · HG-C1000L · FX-550L

Standardized connection to the
field level

Features

■ Connection to the field level

The standardized **IO-Link** technology makes connection to the field level easier than ever before.

Sensors can communicate with the defined masters via EtherCAT, Profinet or EtherNet/IP.

■ Self-diagnosis function

All IO-Link sensors from Panasonic have an integrated self-diagnosis function. The function monitors the function parameters specific to the sensor type and automatically outputs a warning signal if deviations from the specified behavior occur. Users save time because for maintenance it is sufficient to monitor only one signal instead of a number of sensor parameters.

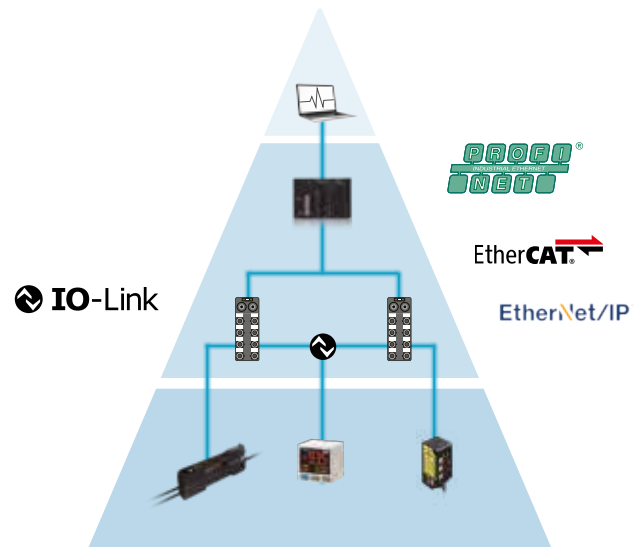

Technical specifications

■ HG-C1000L

Cable type	HG-C1030L3-P	HG-C1050L3-P	HG-C1100L3-P	HG-C1200L3-P	HG-C1400L3-P
M12 connector type	HG-C1030L3-P-J	HG-C1050L3-P-J	HG-C1100L3-P-J	HG-C1200L3-P-J	HG-C1400L3-P-J
Measuring range	30±5mm	50±15mm	100±35mm	200±80mm	400±200mm
Repeatability	10µm	30µm	70µm	200µm	300µm (200-400mm) 800µm (400-600mm)
Linearity	±0.1% F.S.			±0.2% F.S.	±0.3% F.S.
Beam diameter	Approx. 50µm	Approx. 70µm	Approx. 120µm	Approx. 300µm	Approx. 500µm
Beam source	Red semiconductor laser (655nm), Class 2 (JIS/IEC/GB)/Class II (FDA)				
Supply voltage	12 to 24V DC ±10%				
Switching and communication line (C/Q)	Communication specification	IO-Link specification V1.1			
	Baud rate	COM3 (230.4kbit/s)			
	Process data	4 bytes			
	Transmission cycle time	1ms			
Control output (DO)	PNP open-collector transistor, max. 50mA				
Response time	Switchable between high speed (1.5ms), standard (5ms), and high precision (10ms)				
Degree of protection	IP67				
Cable	Cable type: 4-wire PVC cable, 2m M12 connector type: 4-wire PVC cable, 0.3m				
Material	Enclosure: die-cast aluminum, front cover: acrylic				
Dimensions (HxWxD)	44x20x25mm				

DP-100L

Type	Pigtailed type		M12 connector type		
	Low pressure type	High pressure type	Low pressure type	High pressure type	
Model number	DP-101ZL3-M-P	DP-102ZL3-M-P	DP-101ZL3-M-P-C	DP-102ZL3-M-P-C	
Rated pressure range (note 1)	-1 bar to 1 bar (-100.0 to +100.0kPa)	-1 bar to +10 bar (-0.100 to +1.0MPa)	-1 to 1 bar (-100.0 to +100.0kPa)	-1 bar to +10 bar (-0.100 to +1.0MPa)	
Applicable fluid	Non-corrosive gas				
Supply voltage	12 to 24V DC \pm 10%				
Switching and communication line (C/Q)	Communication specification	IO-Link specification V1.1			
	Baud rate	COM3 (230.4kbit/s)			
	Process data	4 bytes			
	Transmission cycle time	1ms			
Control output (DO)	PNP open-collector transistor, max. 50mA				
Output operation	Output operation	Normally open contact (NO) / normally closed contact (NC) selectable			
	Output modes	3 modes: EASY, hysteresis mode, window comparator mode			
	Hysteresis	Minimum 1 digit (variable)			
	Repeatability (within \pm 2 digits)	\pm 0.1% FS	\pm 0.2% FS	\pm 0.1% FS	\pm 0.2% FS
	Response time	2.5ms, 5ms, 10ms, 25ms, 50ms, 100ms, 250ms, 500ms, 1000ms, 5000ms selectable by key operation			
LED indicator	LED (orange)				
Pressure port	M5 female thread				
Material	Housing: PBT, LC display: Acrylic, Pressure port: SUS 303, thread: brass, buttons: silicon rubber				
Connection method	Connector (note 2)		M12 connector		
Dimensions (HxWxD)	30x30x42.5mm				
Accessories	CN-14A-C2 pigtail type 2m: 1 pc.		M12 connector cable 0.3m: 1 pc.		

- Notes:**
- 1.) Where measurement conditions have not been specified precisely, the conditions used were an ambient temperature of +20°C. Reference pressure = 1atm
 - 2.) The cable CN-14A-C2 is included

FX-550L

Type	Pigtailed type	M12 connector type
Model number	FX-551L3-P-C2	FX-551L3-P-J
Supply voltage	12 to 24V DC \pm 10%	
Switching and communication line (C/Q)	Communication specification	IO-Link specification V1.1
	Baud rate	COM3 (230.4kbit/s)
	Process data	4 bytes
	Transmission cycle time	1ms
Control output (DO)	PNP open-collector transistor, max. 50mA	
Emitting element (modulated)	Red LED (Peak emission wavelength: 660nm)	
Response time	Adjustable. STD: min. 250 μ s, LONG: min. 2ms, U-LG: min. 4ms, HYPR: min. 24ms	
Sensitivity setting	2-point teaching, limit teaching, full auto-teaching, manual adjustment	
Incident light sensitivity setting	Incorporated, 4 steps	
Incident light intensity display range	Adjustable. STD: 0 to 4000, LONG: 0 to 8000, U-LG / HYPR: 0 to 9999	
Degree of protection	IP40	
Ambient temperature	-10 to +55°C	
	For 4 to 7 sensors in series connection: -10 to +50°C; for 8 to 16 sensors in series connection: -10 to +45°C (no condensation or freezing). Storage: -20 to +70°C	
Connection method	0.2mm ² 4-core cab tire cable, 2m	0.2mm ² 4-core cab tire cable with M12 connector, 0.3m
Material	Housing and protective cover: Polycarbonate; buttons: Polyacetal	
Dimensions (HxWxD)	34x10x75mm	

IO-Link
SensorsPhotoelectric
SensorsFiber-optic
Sensors

Standard Fibers

Fiber Sensors
Communication
Units

Mark Sensors

Laser Sensors

Safety Sensors

Pressure &
Flow SensorsInductive
Proximity
SensorsMeasurement
SensorsIonizers/
Electrostatic
Sensors

Accessories

IO-Link
Sensors

- IO-Link Sensors
- Photoelectric Sensors
- Fiber-optic Sensors
- Standard Fibers
- Fiber Sensors Communication Units
- Mark Sensors
- Laser Sensors
- Safety Sensors
- Pressure & Flow Sensors
- Inductive Proximity Sensors
- Measurement Sensors
- Ionizers/ Electrostatic Sensors
- Accessories



GX-300

Cylindrical inductive sensor with IO-Link type

Features

IOT ready

With the implemented IO-Link technology network integration is easy. The IO-Link models can be used as normal digital PNP output sensors or providing information about the sensor level

or the current sensor condition via IO-Link interface. This is perfect for predictive maintenance and applications with higher expectations.

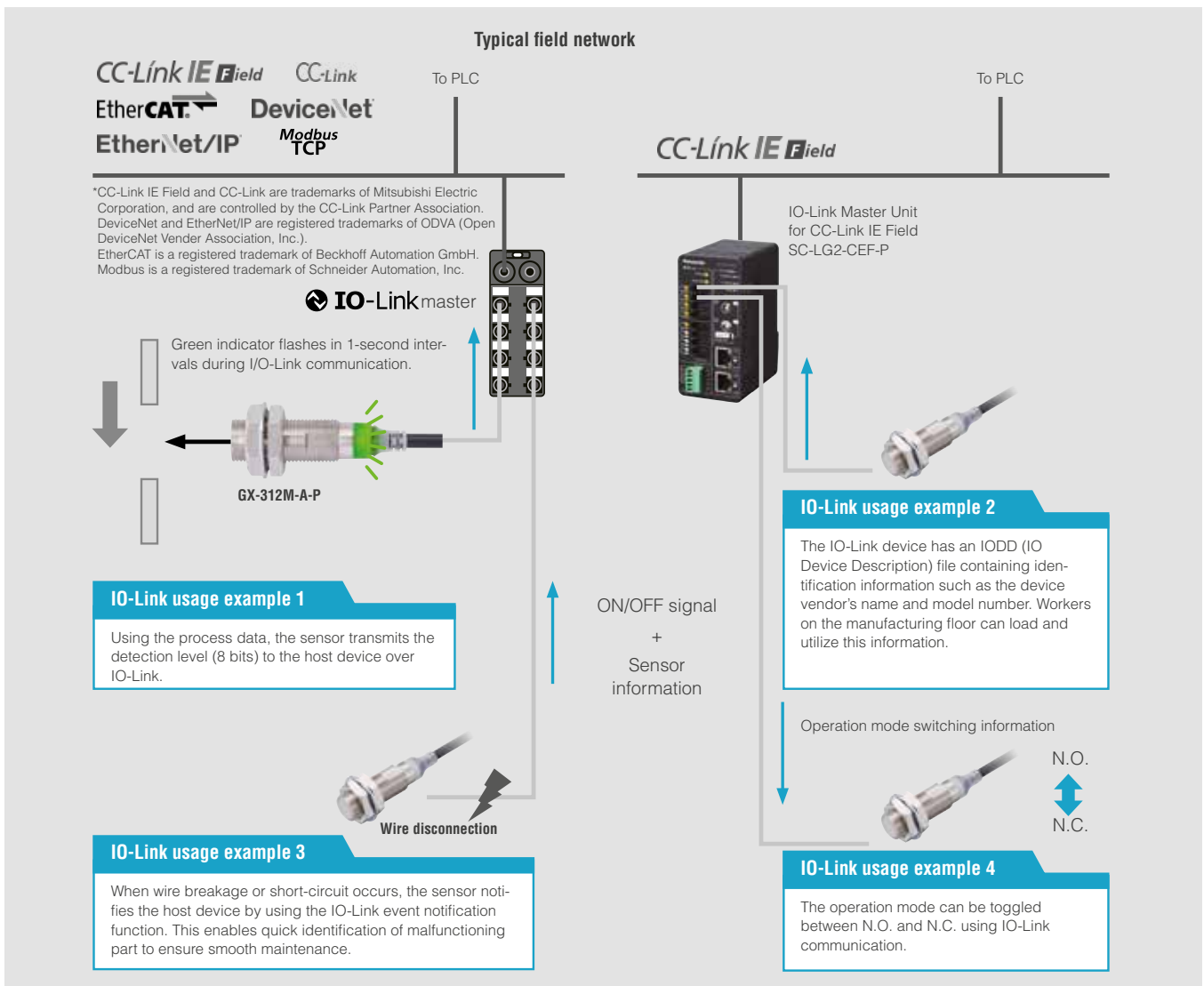

DC 3-wire type (Shielded type)

Type		Shielded type			
		Threaded type			
Model No. (note 2)	Normally Open	GX-308M-A-P-□	GX-312M-A-P-□	GX-318M-A-P-□	GX-330M-A-P-□
Rated sensing distance		1.5mm	2.0mm	5mm	10mm
Stable sensing distance (note 3)		0 to 1.2mm	0 to 1.6 mm	0 to 4 mm	0 to 8mm
Standard sensing object (note 7)		8x8mm	12x12mm	18x18mm	30x30mm
Hysteresis		Max. 10% of measurement distance			
Supply voltage (note 4)		10-30V DC ±10% (note1)			
Current consumption		max. 16mA			
Control output		PNP open-collector transistor, 200mA (note 2)			
Switching and communication line (C/Q)	Communication specification	IO-Link specification V1.1			
	Baud rate	COM3 (230.4kbit/s)			
	Process data	PD size: 2 bytes, OD size: 1 byte (M-sequence type: TYPE2_2)			
	Transmission cycle time	0.4ms			
Response Frequency (note 5)		2kHz	1.5kHz	0.6kHz	0.4kHz
Protection		IP67 (IEC)			
Ambient temperature		-40 to +85°C			
Dimension (HxWxD)		M8x37.8mm	M12x47.1mm	M18x55.3mm	M30x60.3mm
Material		Case: Nickel-plated brass [stainless steel (SUS303) for GX-308M(K)-□], Sensing part: Polybutylene terephthalate (PBT)			
Connection method (note 6)		Cable, 2m or 5m; M12 connector type; pigtail type			

DC 3-wire type (Shielded type, long sensing range)

Type		Shielded type			
		Long sensing range			
		Threaded type			
Model No. (note 2)	Normally Open	GX-308MK-A-P-□	GX-312MK-A-P-□	GX-318MK-A-P-□	GX-330MK-A-P-□
Rated sensing distance		2.0mm	4.0mm	8mm	15mm
Stable sensing distance (note 3)		0 to 1.6mm	0 to 3.2mm	0 to 6.4mm	0 to 12mm
Standard sensing object (note 7)		8x8mm	12x12mm	18x18mm	30x30mm
Hysteresis		Max. 15% of measurement distance			
Supply voltage (note 4)		10-30V DC ±10% (note1)			
Current consumption		max. 16mA			
Control output		PNP open-collector transistor, 200mA (note 2)			
Switching and communication line (C/Q)	Communication specification	IO-Link specification V1.1			
	Baud rate	COM3 (230.4kbit/s)			
	Process data	PD size: 2 bytes, OD size: 1 byte (M-sequence type: TYPE2_2)			
	Transmission cycle time	0.4ms			
Response Frequency (note 5)		1.5kHz	1.kHz	0.5kHz	0.25kHz
Protection		IP67 (IEC)			
Ambient temperature		-40 to +85°C			
Dimension (HxWxD)		M8x37.8mm	M12x47.1mm	M18x55.3mm	M30x60.3mm
Material		Case: Nickel-plated brass [stainless steel (SUS303) for GX-308M(K)-□], Sensing part: Polybutylene terephthalate (PBT)			
Connection method (note 6)		Cable, 2m or 5m; M12 connector type; pigtail type			

Notes:

- Where measurement conditions have not been specified precisely, the conditions ambient temperature +23°C
- Suffix -P = PNP type
- The specified stable sensing distance is the range in which the sensor works reliably even in case of deviations in temperature or voltage
- When used at a power of 12 V, the product is less susceptible to the effects of internal self-heat generation and therefore a more stable repeat accuracy can be obtained
- The response frequency is an average value.
- Suffix -C5 = 5m cable / Suffix -J = Pigtail 0.3m with M12 connector / Suffix -Z = M12 connector type
- Standard sensing object = sheet steel, thickness: 1mm

IO-Link
SensorsPhotoelectric
SensorsFiber-optic
Sensors

Standard Fibers

Fiber Sensors
Communication
Units

Mark Sensors

Laser Sensors

Safety Sensors

Pressure &
Flow SensorsInductive
Proximity
SensorsMeasurement
SensorsIonizers/
Electrostatic
Sensors

Accessories

IO-Link
Sensors

DC 3-wire type (Non-shielded type)

Type		Non-shielded type			
		Threaded type			
Model No. (note 2)	Normally Open	GX-308ML-A-P-□	GX-312ML-A-P-□	GX-318ML-A-P-□	GX-330ML-A-P-□
Rated sensing distance		2.0mm	5.0mm	10mm	18mm
Stable sensing distance (note 3)		0 to 1.6 mm	0 to 4 mm	0 to 8 mm	0 to 14.4 mm
Standard sensing object (note 7)		8x8mm	12x12mm	18x18mm	30x30mm
Hysteresis		Max. 10% of measurement distance			
Supply voltage (note 4)		10-30V DC ±10% (note1)			
Current consumption		max. 16mA			
Control output		PNP open-collector transistor, 200mA (note 2)			
Switching and communication line (C/Q)	Communication specification	IO-Link specification V1.1			
	Baud rate	COM3 (230.4kbit/s)			
	Process data	PD size: 2 bytes, OD size: 1 byte (M-sequence type: TYPE2_2)			
	Transmission cycle time	0.4ms			
Response Frequency (note 5)		1kHz	0.8kHz	0.4kHz	0.1kHz
Protection		IP67 (IEC)			
Ambient temperature		-40 to +85°C			
Dimension (HxWxD)		M8x37.8mm	M12x47.1mm	M18x55.3mm	M30x60.3mm
Material		Case: Nickel-plated brass [stainless steel (SUS303) for GX-308ML(K)-□], Sensing part: Polybutylene terephthalate (PBT)			
Connection method (note 6)		Cable, 2m or 5m; M12 connector type; pigtail type			

Notes:

- Where measurement conditions have not been specified precisely, the conditions ambient temperature +23°C
- Suffix -P = PNP type
- The specified stable sensing distance is the range in which the sensor works reliably even in case of deviations in temperature or voltage
- When used at a power of 12 V, the product is less susceptible to the effects of internal self-heat generation and therefore a more stable repeat accuracy can be obtained
- The response frequency is an average value.
- Suffix -C5 = 5m cable
Suffix -J = Pigtail 0.3m with M12 connector
Suffix -Z = M12 connector type
- Standard sensing object = sheet steel, thickness: 1mm

DC 3-wire type (Non-shielded type, long sensing range)

Type		Non-shielded type			
		Long sensing range			
		Threaded type			
Model No. (note 2)	Normally Open	GX-308MLK-A-P-□	GX-312MLK-A-P-□	GX-318MLK-A-P-□	GX-330MLK-A-P-□
Rated sensing distance		4mm	8mm	16mm	30mm
Stable sensing distance (note 3)		0 to 3.2 mm	0 to 6.4 mm	0 to 12.8 mm	0 to 24 mm
Standard sensing object (note 7)		12x12mm	24x24mm	48x48mm	90x90mm
Hysteresis		Max. 15% of measurement distance			
Supply voltage (note 4)		10-30V DC ±10% (note1)			
Current consumption		max. 16mA			
Control output		PNP open-collector transistor, 200mA (note 2)			
Switching and communication line (C/Q)	Communication specification	IO-Link specification V1.1			
	Baud rate	COM3 (230.4kbit/s)			
	Process data	PD size: 2 bytes, OD size: 1 byte (M-sequence type: TYPE2_2)			
	Transmission cycle time	0.4ms			
Response Frequency (note 5)		1.5kHz	1.kHz	0.5kHz	0.25kHz
Protection		IP67 (IEC)			
Ambient temperature		-40 to +85°C			
Dimension (HxWxD)		M8x37.8mm	M12x47.1mm	M18x55.3mm	M30x82.3mm
Material		Case: Nickel-plated brass [stainless steel (SUS303) for GX-308M(K)-□], Sensing part: Polybutylene terephthalate (PBT)			
Connection method (note 6)		Cable, 2m or 5m; M12 connector type; pigtail type			

Notes:

- Where measurement conditions have not been specified precisely, the conditions ambient temperature +23°C
- Suffix -P = PNP type
- The specified stable sensing distance is the range in which the sensor works reliably even in case of deviations in temperature or voltage
- When used at a power of 12 V, the product is less susceptible to the effects of internal self-heat generation and therefore a more stable repeat accuracy can be obtained
- The response frequency is an average value.
- Suffix -C5 = 5m cable
Suffix -J = Pigtail 0.3m with M12 connector
Suffix -Z = M12 connector type
- Standard sensing object = sheet steel, thickness: 1mm



Services that make a difference

To ensure that our customers get the best out of our products and solutions we provide a complete package of services. Our experienced sales engineers, product specialists, product management and technical engineers consult on any new project and provide our customers with recommendations for the ideal products and solutions for each individual task. That is the reason why products and solutions of Panasonic Industry are considered highly reliable.

- › Product & project consulting
- › Feasibility studies
- › Local laboratory tests
- › Customizing
- › Installation support
- › Panasonic Academy
- › Technical Support
- › Inhouse repairs
- › Warranty & claim handling
- › Discontinuation consulting





CX-400

A full lineup of world standard photoelectric sensors

Features

Great lineup of 170 models

The **CX-400** series has a high level of basic functionality and excellent cost performance. Moreover, a wide number of variations means that there is sure to be a sensor that fits your needs.

Type	Sensing range
CX-412 □ Thru-beam (long sensing range)	15m
CX-411 □ Thru-beam	10m
CX-493 □ Retroreflective (long sensing range)	5m
CX-491 □ Retroreflective (with polarizing filters)	3m
CX-482 □ Retroreflective (transparent object sensing)	0.1 – 2m
CX-481 □ Retroreflective (transparent object sensing)	50 – 500mm
CX-422 □ Diffuse reflective (800mm type)	800mm
CX-421 □ Diffuse reflective (300mm type)	300mm
CX-424 □ Diffuse reflective (100mm type)	100mm
CX-423 □ Diffuse reflective (narrow-view)	70 – 200mm
CX-442 □ Adjustable range reflective	20 – 300mm
CX-444 □ Adjustable range reflective	15 – 100mm
CX-443 □ Adjustable range reflective	2 – 50mm
CX-441 □ Adjustable range reflective (small spot)	2 – 50mm

Output	NPN, PNP
Connecting method (note 1)	Cable type, M8 plug-in connector type, M12 pigtailed type
Cable length of cable type (note 2)	0.5m, 2m, 5m

Notes:

- 1.) Only the cable type and M8 plug-in connector type are available for the adjustable range reflective type.
- 2.) Only the 2m cable length type (standard) is available for the adjustable range reflective type.

Compact size

The sensors are compact in size at 11.2x31x20mm (WxHxD). The mounting pitch is also at the world standard size of 25.4mm.

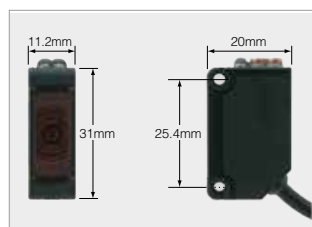

Less processing

M8 plug-in connector type and M12 pigtailed type are available. This contributes to less time spent setting up. In addition, cable types are available with the following cable lengths: 0.5m, 2m, and 5m.

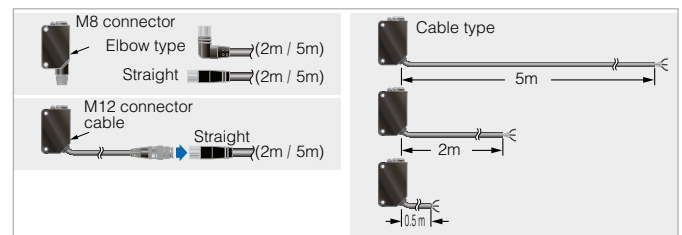

Less power consumed

By relentlessly developing our technologies, we have been able to considerably reduce our sensors' power consumption.

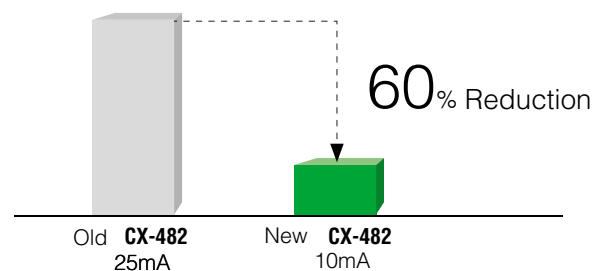

Less resources used

Based on environmental considerations, simplified packaging is used in order to reduce waste.

In addition, the bag is made of polyethylene, which produces no toxic gases even when burned.

CX-41□/42□/49□

Strong against oil and coolant liquids

The lens material for the thru-beam type, retroreflective type (excluding the CX-48□) and the diffuse reflective type is made of a strong acrylic that resists the harmful effects of coolants. These sensors can be used with confidence even around metal processing machinery that disperses oil mists. The protection mechanism also conforms to IP67 (IEC).

CX-44□/48□

Strong against ethanol

A strong, ethanol-resistant polycarbonate is used for the front and display covers. Safe even for installing near food processing machinery that disperses ethanol-based detergents. The protection mechanism also conforms to IP67 (IEC).

Strong against interference

The interference prevention function allows two sensors to be mounted close together.

Typical applications

Detecting cars on conveyor lines



Detecting transparent bottles



Detecting labels

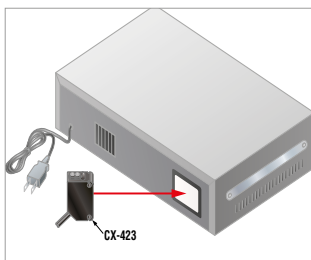

Detecting transparent glass bottles

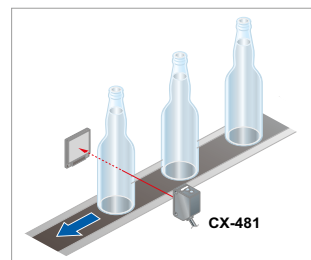

Thru-beam type CX-412□

Strong infrared beam

It realizes a 15m long-distance sensing range. Remarkable penetrating power enables applications such as package content detection.

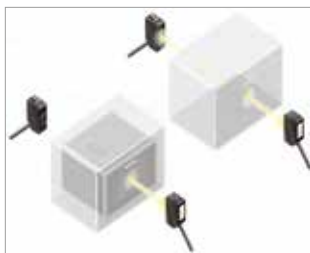

Retroreflective type CX-493□

Strongest sensing range in its class

A long 5m sensing range is possible with the red LED type that is easy to align with the beam axis. Can be used for wide automatic door shutters.



Diffuse reflective type CX-423□

Beam axis alignment made easy

These sensors realize a high luminance red LED spot that provides bright visibility enabling the sensing position to be checked at a glance. Because it has the small spot, approx. 2mm, even the minutest object can be accurately detected.

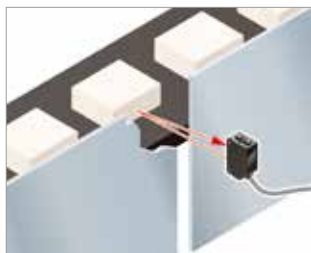

CX-481□/482□

Introducing the transparent object sensing type sensor

Our unique optical system and transparent object sensing circuitry provide stable sensing of even thinner transparent objects than the conventional models.

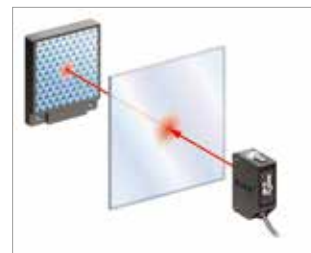

CX-441/443□

Can sense differences as small as 0.4mm, with hysteresis of max. 2%

An advanced optical system provides sensing performance that is approx. 2.5 times more precise than conventional models. Even ultra small differences of 0.4mm can be detected accurately.

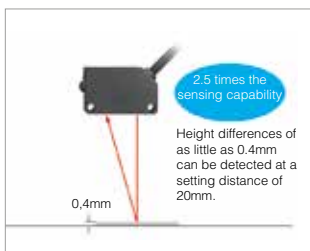

CX-44□

Not affected by color

Both black and white objects can be sensed at almost the same distances. No adjuster control is needed, even when products of different colors are moving along the production line.

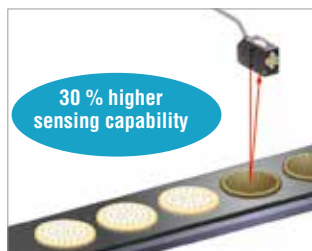

CX-442□

BGS/FGS functions make even the most challenging settings possible!

Background suppression BGS

When object and background are separated.

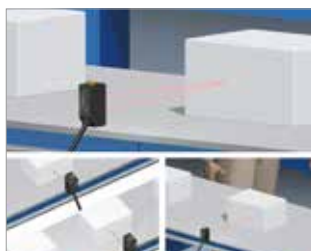

CX-483□

Foreground suppression FGS

When object and background are close together.

When the object is glossy or uneven.



- IO-Link Sensors
- Photoelectric Sensors
- Fiber-optic Sensors
- Standard Fibers
- Fiber Sensors Communication Units
- Mark Sensors
- Laser Sensors
- Safety Sensors
- Pressure & Flow Sensors
- Inductive Proximity Sensors
- Measurement Sensors
- Ionizers / Electrostatic Sensors
- Accessories

CX-440

Technical specifications

IO-Link Sensors
Photoelectric Sensors
Fiber-optic Sensors
Standard Fibers
Fiber Sensors Communication Units
Mark Sensors
Laser Sensors
Safety Sensors
Pressure & Flow Sensors
Inductive Proximity Sensors
Measurement Sensors
Ionizers/ Electrostatic Sensors
Accessories
CX-400

Type		Thru-beam			Retroreflective				
		Long sensing range			With polarizing filter	Long sensing range	For transparent object sensing		
Model no.	NPN output	CX-411(-Z) (note 1)	CX-412(-Z)	CX-413(-Z)	CX-491(-Z)	CX-493(-Z)	CX-481(-Z)	CX-483(-Z)	CX-482(-Z)
	PNP output	CX-411-P(-Z)	CX-412-P(-Z)	CX-413-P(-Z)	CX-491-P(-Z)	CX-493-P(-Z)	CX-481-P(-Z)	CX-483-P(-Z)	CX-482-P(-Z)
Sensing range		10m	15m	30m	3m (note 2)	5m (note 2)	50 to 500mm (note 2)	50 to 1.0m (note 2)	0.1 to 2m (note 2)
Object to be sensed		Min. Ø 12mm (opaque)			Min. Ø 50mm (opaque, transparent) (note 2)	Min. Ø 50mm (opaque, transparent or specular) (note 2)			
Hysteresis		-							
Supply voltage		12 to 24VDC ±10%							
Output		PNP / NPN open-collector transistor, max. 100mA							
Output operation		Switchable either Light-ON or Dark-ON							
Response time		Max. 1ms		Max. 2ms	Max. 1ms				
Emitting element		Red LED	Infrared LED		Red LED			Infrared LED	
Automatic interference prevention function		Two units of sensors can be mounted close together with interference prevention filters. (Sensing range: 5m)		-	Incorporated (two sensor units can be mounted close together.)				
Protection		IP67 (IEC)							
Ambient temperature		-25 to +55°C							
Material		Enclosure: PBT, Lens: Polycarbonate (CX-48□: Polycarbonate), Protection cover: Polycarbonate (CX-48□: Polycarbonate)							
Connection method		2m cable, Suffix - Z: M8 connector (note 3)							
Dimensions (HxWxD)		31x11.2x20mm (-Z connector type: 35.5x11.2x20mm)							
Accessories		-			Reflector: RF-230 1 pc.				

Notes:

- 1.) Suffix -Z = M8 connector type
- 2.) The sensing range is specified for the attached reflector **RF-230**
- 3.) Cable is not included in delivery. Please select under accessories (page 129)

Type		Diffuse reflective				Adjustable range reflective (note 2)			
					Narrow view	Small spot			
Model no.	NPN output	CX-424(-Z) (note 1)	CX-421(-Z)	CX-422(-Z)	CX-423(-Z)	CX-441(-Z)	CX-444(-Z)	CX-442(-Z)	
	PNP output	CX-424-P(-Z)	CX-421-P(-Z)	CX-422-P(-Z)	CX-423-P(-Z)	CX-441-P(-Z)	CX-444-P(-Z)	CX-442-P(-Z)	
Sensing range		100mm	300mm	800mm	70 to 300mm	2 to 50mm (adjustable range: 20-50mm)	15 to 100mm (adjustable range: 20-100mm)	20 to 300mm (adjustable range: 40-300mm)	
Object to be sensed		Opaque, transparent				-			
Hysteresis		Max. 15% of sensing range				Max. 2% of sensing range		Max. 5% of sensing range	
Supply voltage		12 to 24VDC ±10%							
Output		PNP / NPN open-collector transistor, max. 100mA							
Output operation		Switchable either Light-ON or Dark-ON							
Response time		Max. 1ms							
Emitting element		Infrared LED			Red LED	Red LED			
Automatic interference prevention function		Incorporated (two sensor units can be mounted close together.)							
Protection		IP67 (IEC)							
Ambient temperature		-25 to +55°C							
Material		Enclosure: PBT, Lens: Polycarbonate (CX-48□: Polycarbonate), Protection cover: Polycarbonate (CX-48□: Polycarbonate)							
Connection method		2m cable, Suffix - Z: M8 connector (note 3)							
Dimensions (HxWxD)		31x11.2x20mm (-Z connector type: 35.5x11.2x20mm)							

Notes:

- Suffix -Z = M8 connector type
- FGS = Foreground suppression
BGS = Background suppression
Selectable by wiring the inputs correspondingly
- Cable is not included in delivery. Please select under accessories (page 129)

IO-Link
SensorsPhotoelectric
SensorsFiber-optic
Sensors

Standard Fibers

Fiber Sensors
Communication
Units

Mark Sensors

Laser Sensors

Safety Sensors

Pressure &
Flow SensorsInductive
Proximity
SensorsMeasurement
SensorsIonizers/
Electrostatic
Sensors

Accessories

CX-440

IO-Link
SensorsPhotoelectric
SensorsFiber-optic
Sensors

Standard Fibers

Fiber Sensors
Communication
Units

Mark Sensors

Laser Sensors

Safety Sensors

Pressure &
Flow SensorsInductive
Proximity
SensorsMeasurement
SensorsIonizers/
Electrostatic
Sensors

Accessories

NX5



NX5

Sensor usable world-wide

Features

Multi-voltage

24 to 240VAC and 12 to 240VDC, suitable for supply voltages all over the world.

High reliability

The hermetically sealed output relay significantly increases its reliability.

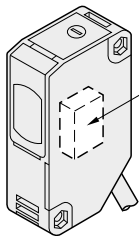

Hermetically sealed relay eliminates worries about bad contact

Interference prevention

Two sensors operate normally even when mounted close together (excluding the 30m thru-beam type sensor).

Long sensing range

Suitable for conveyor lines and parking lot applications.

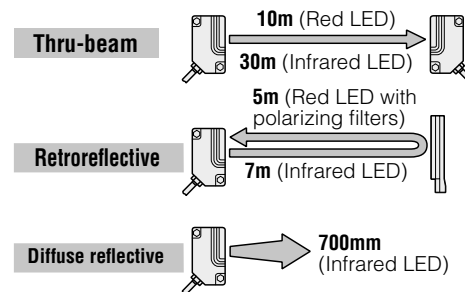

Typical applications

Multistoried parking

Detects if the car is protruding from the elevator door.

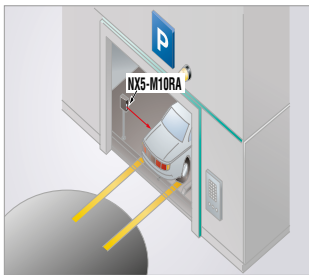

Golf driving range

The sensor detects the presence of a golf ball. The sensor is multi-voltage type so no DC power supply is needed.

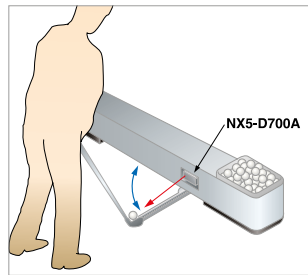

Arresting shutter closing

The long sensing range sensor with a visible red beam can be used to control the shutter operation at the gate of a factory.

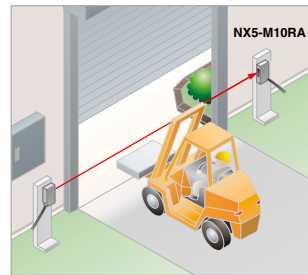

Arresting door closing

The sensor detects a person or an object and prevents the door from closing as long as its beam is interrupted.

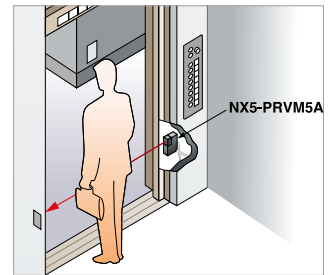

Technical specifications

Type	Thru-beam				Retroreflective				Diffuse reflective	
			Long sensing range		With polarizing filters		Long sensing range			
Model no.	NX5-M10RA	NX5-M10RB	NX5-M30A	NX5-M30B	NX5-PRVM5A	NX5-PRVM5B	NX5-RM7A	NX5-RM7B	NX5-D700A	NX5-D700B
Sensing range	10m		30m		0.1 to 5m (note 1)		0.1 to 7m (note 1)		700mm (note 2)	
Object to be sensed	Min. Ø 20mm (opaque transparent) (note 3)				Min. Ø 50mm (opaque, semi-transparent or transparent) (note 1, 3)		Min. Ø 50mm (opaque or translucent) (note 1, 3)		Opaque, semitransparent or transparent (note 3)	
Hysteresis	—								Max. 15% of sensing range	
Repeatability (perpendicular to sensing axis)	Max. 0.1mm		Max. 0.2mm				Max. 0.3mm			
Supply voltage	24 to 240VAC ± 10%, or 12 to 240VDC ± 10%									
Power consumption	Emitter: max. 1VA Receiver: max. 2VA		Emitter: max. 1.5VA Receiver: max. 2VA		Max. 2VA					
Output	Relay contact 1c Switching capacity: 250V AC 1A (resistive load) 30VDC 2A (resistive load) Electrical life: Min. 500000 switching operations (switching frequency 3600 operations/hour) Mechanical life: Min. 100 million switching operations (switching frequency 36000 operations/hour)									
Output operation	Light-ON	Dark-ON	Light-ON	Dark-ON	Light-ON	Dark-ON	Light-ON	Dark-ON	Light-ON	Dark-ON
Response time	Max. 10ms									
Power indicator	—		Red LED (lights up when the power is ON)			—				
Sensitivity adjuster	Continuously variable adjuster		—		Continuously variable adjuster		—		Continuously variable adjuster	
Automatic interference prevention function	Use optional interference prevention filters		—		Incorporated (two sensor units can be mounted close together.)					
Protection	IP66 (IEC)									
Ambient temperature	-20 to +55°C									
Emitting element	Red LED		Infrared LED		Red LED		Infrared LED			
Material	Enclosure: Polycarbonate; lens: polycarbonate; cover: polycarbonate; front cover (retroreflective type sensor only): Acrylic									
Connection method	5-core (thru-beam type emitter: 2 cable) cable, 2m									
Dimensions (HxWxD)	62x18x35mm									
Accessories	Adjusting screwdriver: 1 pc.		—		Reflector RF-230 : 1 pc. Adjusting screwdriver: 1 pc.		Reflector RF-230 : 1 pc.		Adjusting screwdriver: 1 pc.	

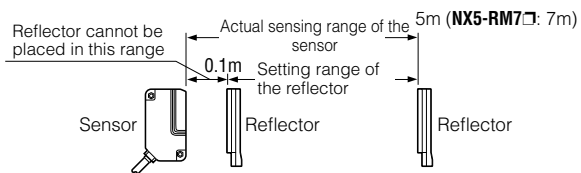

Notes:

- 1.) The sensing range and the object to be sensed of the retroreflective type sensor is specified for the **RF-230**. Further, the sensing range is the possible setting range for the reflector. The sensor can also detect an object 0.1m, or more, away.
- 2.) The sensing range is specified for white non-glossy paper (200x200mm).
- 3.) Check the functionality with a real object.

IO-Link
Sensors

Photoelectric
Sensors

Fiber-optic
Sensors

Standard Fibers

Fiber Sensors
Communication
Units

Mark Sensors

Laser Sensors

Safety Sensors

Pressure &
Flow Sensors

Inductive
Proximity
Sensors

Measurement
Sensors

Ionizers/
Electrostatic
Sensors

Accessories

NX5

IO-Link
SensorsPhotoelectric
SensorsFiber-optic
Sensors

Standard Fibers

Fiber Sensors
Communication
Units

Mark Sensors

Laser Sensors

Safety Sensors

Pressure &
Flow SensorsInductive
Proximity
SensorsMeasurement
SensorsIonizers/
Electrostatic
Sensors

Accessories

CY-100



CY-100

Simple mounting with M18 thread

Features

■ Wide product range

The availability of a wide range of models within the series means the **CY-100** sensors can solve relatively complex tasks. Types with integrated polarization filters can even recognize reflective objects. The side view type makes applications possible in cramped spaces.

■ M18 Thread

All models have an M18 male thread for easy and quick mounting. Furthermore the models are also available for the M12 connector type. You can easily replace and add these standard models. The nuts are included in delivery.

■ Long sensing range

The thru-beam and retroreflective types of the CY-100 have a large sensing range of up to 15m.

■ Environmentally robust

Thanks to the IP67 (IEC) casing, the sensor is suitable for installation in humid and dusty environments. Integrated status LEDs allow the operator to check the function of the sensor at a glance.

Typical applications

Object detection

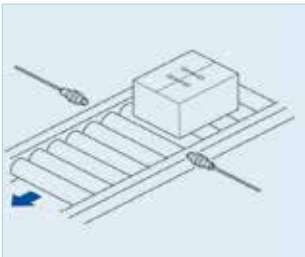

Detecting specular objects

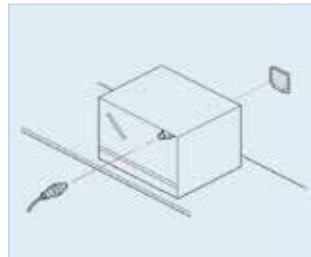

Object counting

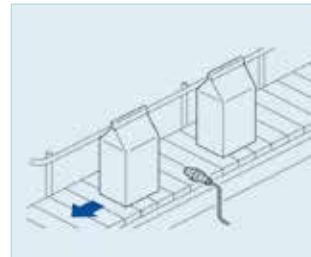

Technical specifications

Standard type

Type		Thru-beam		Retroreflective type (note 3)				Diffuse			
		-		-		With polarizing filter		-		With sensitivity adjuster	
		Light-ON	Dark-ON	Light-ON	Dark-ON	Light-ON	Dark-ON	Light-ON	Dark-ON	Light-ON	Dark-ON
Model no.	NPN output	CY-111A (-Z) (note 1)	CY-111B (-Z)	CY-192A (-Z)	CY-192B (-Z)	CY-191A (-Z)	CY-191B (-Z)	CY-121A (-Z)	CY-121B (-Z)	CY-122A (-Z)	CY-122B (-Z)
	PNP output	CY-111A-P (-Z)	CY-111B-P (-Z)	CY-192A-P (-Z)	CY-192B-P (-Z)	CY-191A-P (-Z)	CY-191B-P (-Z)	CY-121A-P (-Z)	CY-121B-P (-Z)	CY-122A-P (-Z)	CY-122B-P (-Z)
Sensing range		15m		4m		2m		100mm (note 2)		600mm (note 2)	
Object to be sensed		Min. Ø 18mm (opaque)		Min. Ø 50mm (opaque, transparent) (note 1)		Min. Ø 50mm (opaque, transparent or specular) (note 1)		Opaque, transparent			
Supply voltage		12 to 24VDC ±10%									
Output		PNP / NPN open-collector transistor, max. 100mA									
Response time		Max. 1ms									
Emitting element		Infrared LED				Red LED		Infrared LED			
Protection		IP67 (IEC)									
Ambient temperature		-25 to +55°C									
Material		Enclosure: PBT, Lens: PMMA									
Connection method		2m cable, Suffix - Z: M12 connector (note 4)									
Dimensions (HxWxD)		M18x46mm, -Z connector type: M18x60mm				M18 x 48mm, -Z connector type: M18x62mm		M18x46mm, -Z connector type: M18x60mm		M18x62mm, -Z connector type: M18x76mm	
Accessories		Nuts 4 pcs.		Nuts 2 pcs.				Nuts 2 pcs. Screwdriver 1pc.			

Side sensing type

Type		Thru-beam		Retroreflective type (note 3)				Diffuse				
		-		-		With polarizing filter		-		With sensitivity adjuster		
		Light-ON	Dark-ON	Light-ON	Dark-ON	Light-ON	Dark-ON	Light-ON	Dark-ON	Light-ON	Dark-ON	
Model no.	NPN output	CY-111VA(-Z) (note 1)	CY-111VB(-Z)	CY-192VA(-Z)	CY-192VB(-Z)	CY-191VA(-Z)	CY-191VB(-Z)	CY-121VA(-Z)	CY-121VB(-Z)	CY-122VA(-Z)	CY-122VB(-Z)	
	PNP output	CY-111VA-P(-Z)	CY-111VB-P(-Z)	CY-192VA-P(-Z)	CY-192VB-P(-Z)	CY-191VA-P(-Z)	CY-191VB-P(-Z)	CY-121VA-P(-Z)	CY-121VB-P(-Z)	CY-122VA-P(-Z)	CY-122VB-P(-Z)	
Sensing range		15m		4m		2m		100mm (note 2)		600mm (note 2)		
Object to be sensed		Min. Ø 18mm (opaque)		Min. Ø 50mm (opaque, transparent) (note 1)		Min. Ø 50mm (opaque, transparent or specular) (note 1)		Opaque, transparent				
Supply voltage		12 to 24V DC ±10%										
Output		PNP / NPN open-collector transistor, max. 100mA										
Response time		1ms										
Emitting element		Infrared LED				Red LED		Infrared LED				
Protection		IP67 (IEC)										
Ambient temperature		-25 to +55°C										
Material		Enclosure: PBT, Lens: PMMA										
Connection method		2m cable, Suffix - Z: M12 connector (note 4)										
Dimensions (ØxD)		M18x62mm, -Z connector type: M18x76mm						M18x46mm, -Z connector type: M18x60mm	-	M18x78mm, -Z connector type: M18x92mm		
Accessories		Nuts 4 pcs.		Nuts 2 pcs.				Nuts 2 pcs. Screwdriver 1 pc.				

Notes:

Suffix -Z = M12 connector type

- 1.) The sensing range and object to be sensed of the retroreflective type are specified for the reflector **RF-420** (accessories page 130)
- 2.) The sensing range is specified for white, matt paper
- 3.) The reflector is not included in delivery; please order separately (accessories page 130)
- 4.) Cable not included in delivery; please order separately (accessories page 129)

IO-Link
Sensors

Photoelectric
Sensors

Fiber-optic
Sensors

Standard Fibers

Fiber Sensors
Communication
Units

Mark Sensors

Laser Sensors

Safety Sensors

Pressure &
Flow Sensors

Inductive
Proximity
Sensors

Measurement
Sensors

Ionizers/
Electrostatic
Sensors

Accessories

CY-100

IO-Link
SensorsPhotoelectric
SensorsFiber-optic
Sensors

Standard Fibers

Fiber Sensors
Communication
Units

Mark Sensors

Laser Sensors

Safety Sensors

Pressure &
Flow SensorsInductive
Proximity
SensorsMeasurement
SensorsIonizers/
Electrostatic
Sensors

Accessories

EX-Z

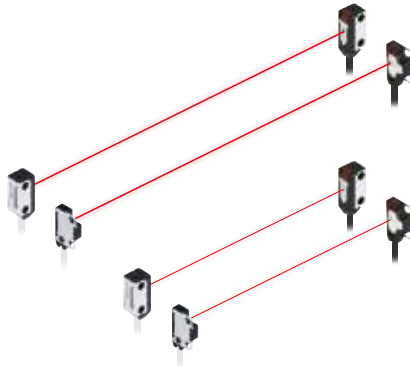

Features

■ Smallest laser sensor with a built-in amplifier

The extreme thinness of 3mm of the **EX-Z** series has been achieved by utilizing a new semiconductor packaging technology that does not use wire bonding. The small unit size allows the installation of sensors in a narrow space where only a conventional fiber sensor head could be installed before. As opposed to a fiber sensor, the EX-Z has a built-in amplifier, which also saves on installation space.

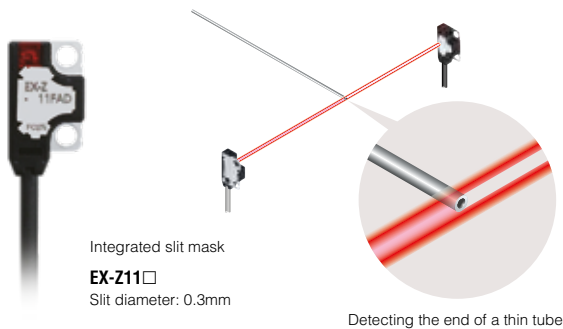

■ Easy to install

The clearly visible red light beam makes installation and beam alignment very simple. The 4-element LED provides a stable strong light over a long period of time.

■ Great performance in an industrial environment

With IP67 degree of protection, the EX-Z can be installed in environments where water is used or splashed¹. For this type of application, there are rustproof mounting brackets available in stainless steel and plastic.

¹ If water splashes on the sensor during sensing operation, the sensor may detect the water as an object

EX-Z

Miniature thru-beam sensor with built-in amplifier

Front sensing

Approx.
50% smaller
than EX-10

EX-Z1□F□
H14×W8×D3 mm

Side sensing

Approx.
35% smaller
than EX-10

EX-Z1□
H15.9×W5.5×D6.5 mm

■ Sensing extremely small objects

Thanks to the integrated slit mask, the sensor can detect objects with a diameter of as little as 0.3mm. Even at a distance of 500mm, the sensor is capable of reliably detecting objects as small as 1mm.



Detection of parts in parts feeder

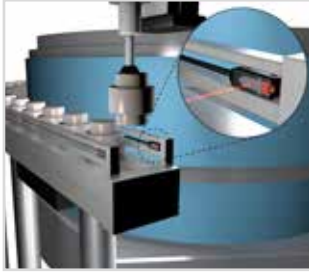

Detection of presence / absence of test tubes

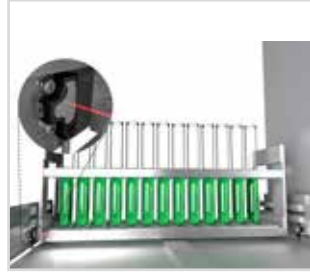

Detection of LED contacts



Mounted on robot arm

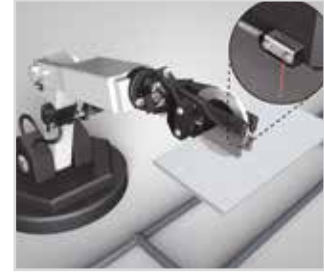

Technical specifications

Standard type

Type		Thru-beam					
		Front sensing			Side sensing		
Model number	Light-ON	EX-Z11FA (-P) (note)	EX-Z12FA (-P)	EX-Z13FA (-P)	EX-Z11A (-P)	EX-Z12A (-P)	EX-Z13A (-P)
	Dark-ON	EX-Z11FB (-P)	EX-Z12FB (-P)	EX-Z13FB (-P)	EX-Z11B (-P)	EX-Z12B (-P)	EX-Z13B (-P)
Sensing range		50mm	200mm	500mm	50mm	200mm	500mm
Object to be sensed		Min. Ø 0.3mm	Min. Ø 0.5mm	Min. Ø 1.0mm	Min. Ø 0.3mm	Min. Ø 0.5mm	Min. Ø 1.0mm
Supply voltage		12 to 24V DC ±10%					
Output		NPN / PNP open-collector transistor, max. 20mA					
Response time		Max. 0.5ms					
Degree of protection		IP67 (IEC)					
Ambient temperature		-10 to +55°C					
Connection method		2m cable					
Dimensions (HxWxD)		14x8x3mm			15.5x5.5x6.5mm		
Accessories		Mounting screws, 1 set					

Note:
Suffix P= PNP output
No suffix = NPN type

IO-Link
Sensors

Photoelectric
Sensors

Fiber-optic
Sensors

Standard Fibers

Fiber Sensors
Communication
Units

Mark Sensors

Laser Sensors

Safety Sensors

Pressure &
Flow Sensors

Inductive
Proximity
Sensors

Measurement
Sensors

Ionizers/
Electrostatic
Sensors

Accessories

EX-Z

IO-Link
SensorsPhotoelectric
SensorsFiber-optic
Sensors

Standard Fibers

Fiber Sensors
Communication
Units

Mark Sensors

Laser Sensors

Safety Sensors

Pressure &
Flow SensorsInductive
Proximity
SensorsMeasurement
SensorsIonizers/
Electrostatic
Sensors

Accessories

EX-10



EX-10

The slimmest: 3.5mm thick

Features

■ Optimized precision optics

The enhanced EX-10 series offers a more precise light beam compared with the other standard models. Now you can realize an even more space saving installation, because no additional tools like slit masks are needed to prevent interferences. It is no problem to detect smallest objects with a diameter of 0.5mm.

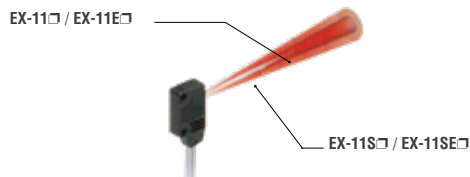

■ Sensing range 1m: EX-19□

■ High-speed response time: 0.5ms

The sensor EX-10 with a response time of only 0.5ms is especially suitable for detecting small and high-speed traveling objects.

■ Flexible setup

The EX-10 sensor is available as front sensing or side sensing type, allowing for flexible mounting in the narrowest of spaces.

■ 2-color indicator

A convenient bright, 2-color indicator has been incorporated in the miniature body. You can check the available power supply and current output operation at a glance.



■ Freely mountable fingertip size

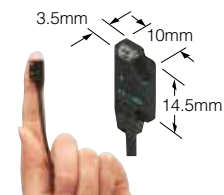

Freely mountable; dimensions 10x14.5x3.5mm (WxHxD) (Thru-beam type, front sensing). Moreover, easy alignment is possible with the visible red LED beam source.

Typical applications

Detecting the float for a flow meter

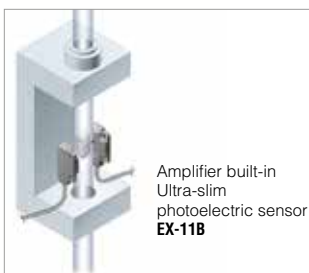

Seating confirmation fiber

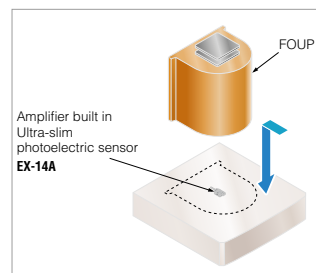

Detecting small parts such as screws

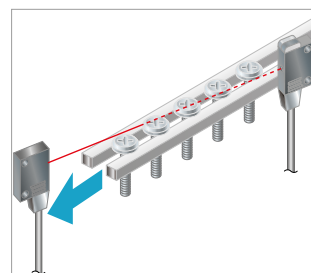

Sensing PCB rack screws

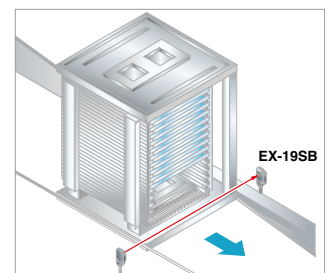

Technical specifications

Type		Thru-beam						Convergent reflective	
Model no.	Front sensing	EX-11A(-PN) (note)	EX-11B(-PN)	EX-13A(-PN)	EX-13B(-PN)	EX-19A(-PN)	EX-19B(-PN)	EX-14A(-PN)	EX-14B(-PN)
	Side sensing	EX-11EA(-PN)	EX-11EB(-PN)	EX-13EA(-PN)	EX-13EB(-PN)	EX-19EA(-PN)	EX-19EB(-PN)	–	–
Sensing range		150mm		500mm		1m		2 to 25mm (conv. point: 10mm)	
Object to be sensed		Min. Ø 1mm (opaque)		Min. Ø 2mm (opaque)				Min. Ø 0.1mm copper wire (Setting distance: 10mm)	
Supply voltage		12 to 24V DC ± 10 %							
Output		PNP/NPN open-collector transistor, max. 50mA							
Output operation		Light-ON	Dark-ON	Light-ON	Dark-ON	Light-ON	Dark-ON	Light-ON	Dark-ON
Response time		Max. 0.5ms							
Protection		IP67 (IEC)							
Ambient temperature		-25 to +55°C							
Connection method		2m cable							
Dimensions (HxWxD)		14.5x10x3.5mm						13x14.5x3.5mm	
Accessories		Mounting screws, 1 set							

Note:
 Suffix -PN = PNP type
 No suffix = NPN type

■ Narrow-view type

Type		Thru-beam				
		Front sensing	Side sensing	Front sensing	Side sensing	Front sensing
Model no.	Light-ON	EX-11SA(-PN) (note)	EX-11SEA(-PN)	EX-13SA(-PN)	EX-13SEA(-PN)	EX-19SA(-PN)
	Dark-ON	EX-11SB(-PN)	EX-11SEB(-PN)	EX-13SB(-PN)	EX-13SEB(-PN)	EX-19SB(-PN)
Sensing range		150mm		500mm		1m
Object to be sensed		Min. Ø 0.5mm (opaque)	Min. Ø 1.0mm (opaque)	Min. Ø 1.0mm (opaque)	Min. Ø 2.0mm (opaque)	Min. Ø 2.0mm (opaque)
Supply voltage		12 to 24V DC ± 10%				
Output		PNP/NPN open-collector transistor, max. 50mA				
Response time		Max. 0.5ms				
Protection		IP67 (IEC)				
Ambient temperature		-25 to +55°C				
Connection method		2m cable				
Dimensions (HxWxD)		14.5x10x3.5mm				
Accessories		Mounting screws, 1 set				

Note:
 Suffix -PN = PNP type
 No suffix = NPN type

IO-Link
SensorsPhotoelectric
SensorsFiber-optic
Sensors

Standard Fibers

Fiber Sensors
Communication
Units

Mark Sensors

Laser Sensors

Safety Sensors

Pressure &
Flow SensorsInductive
Proximity
SensorsMeasurement
SensorsIonizers/
Electrostatic
Sensors

Accessories

EX-10

IO-Link
SensorsPhotoelectric
SensorsFiber-optic
Sensors

Standard Fibers

Fiber Sensors
Communication
Units

Mark Sensors

Laser Sensors

Safety Sensors

Pressure &
Flow SensorsInductive
Proximity
SensorsMeasurement
SensorsIonizers/
Electrostatic
Sensors

Accessories

EX-20



EX-20

Miniature-sized and still mountable
with M3 screws

Features

■ Long sensing range

The **EX-20** series achieves long distance sensing [thru-beam type: 2m, retroreflective type: 200mm (when using the attached reflector), diffuse reflective type: 160mm], despite its miniature size. Hence, it is usable even on a wide conveyor.

■ Clear beam spot using red LED dot light source

The emission area of a dot light source is smaller than that of a conventional LED flat light source. It is possible to design a high power, narrow beam. Since a red LED dot light source is used, the red beam spot is clearly visible even at a long distance so that the alignment and confirmation of the sensing position is easy.

■ Less power consumed!

By relentlessly developing our technologies, we have been able to considerably reduce our sensors' power consumption.

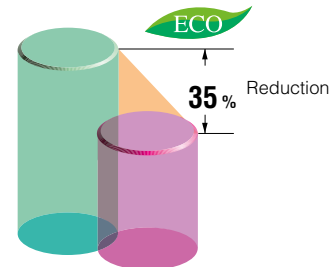
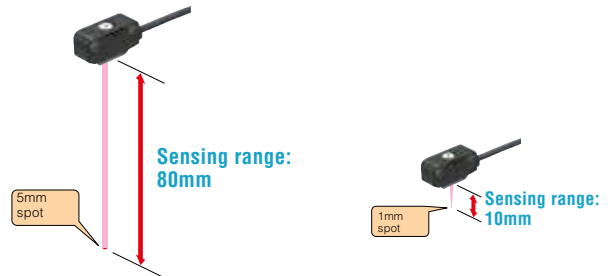

Typical applications

Checking protrusion of wafer

The ultra compact photoelectric sensor EX-23 has a sufficiently long sensing range of 2m. Further, its visible red LED beam makes beam alignment very easy.

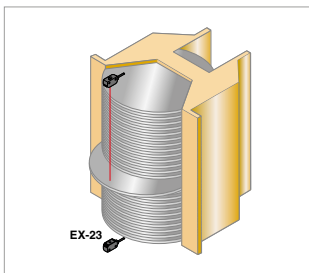

Detecting tape feeder cassette out of position

Ultra compact in size with an ample sensing range of 2m, ideal for monitoring tape feeder cassettes that are out of position.

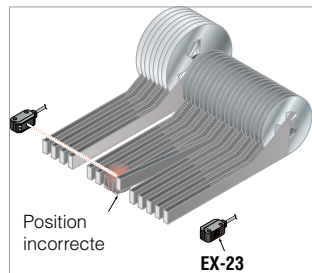

Detecting fill-up of parts in feeder

The sensor setting can be finely adjusted since a universal sensor mounting bracket is available, with which the height and the angle of the sensor can be freely adjusted.

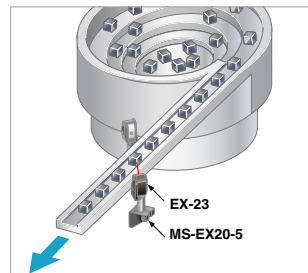

Technical specifications

Type		Thru-beam		Retroreflective	Diffuse reflective type			
					Standard type	Diffuse beam	Small spot beam	Long distance spot beam
		Front sensing	Side sensing	Side sensing	Side sensing	Front sensing	Side sensing	Side sensing
Model no.	Light-ON	EX-21A(-PN) (note)	EX-23(-PN) Light-ON/ Dark-ON switchable	EX-29A(-PN)	EX-22A(-PN)	EX-24A(-PN)	EX-26A(-PN)	EX-28A(-PN)
	Dark-ON	EX-21B(-PN)		EX-29B(-PN)	EX-22B(-PN)	EX-24B(-PN)	EX-26B(-PN)	EX-28B(-PN)
Sensing range		1m	2m	30 to 200mm	5 to 160mm	2 to 25mm (Conv. point: 10mm)	6 to 14mm (Conv. point: 10mm)	45 to 115mm
Object to be sensed		Min. Ø 2.6mm (opaque)	Min. Ø 3mm (opaque)	Min. Ø 15mm opaque or translucent object	Opaque, translucent or transparent object	Min. Ø 0.1mm copper wire (Setting distance: 10mm)		Opaque, translucent or transparent object
Supply voltage		12 to 24VDC ± 10%						
Output		PNP / NPN open-collector transistor, max. 50mA						
Response time		Max. 0.5ms						
Protection		IP67 (IEC)						
Ambient temperature		-25 to +55°C						
Connection method		Cable 2m						
Dimensions (HxWxD)		18x16x4.5mm	8.2x22x10.5mm	8.2x25x12.3mm		16x18x4.5mm	8.2x25x12.3mm	10x14.5x3.5mm
Accessories		–	Screwdriver, 1 pc.	Reflector RF-200 , 1 pc. Screwdriver, 1 pc.	Screwdriver, 1 pc.	–	Screwdriver, 1 pc.	

Note:
Suffix -PN = PNP type
No suffix = NPN type

10-Link
SensorsPhotoelectric
SensorsFiber-optic
Sensors

Standard Fibers

Fiber Sensors
Communication
Units

Mark Sensors

Laser Sensors

Safety Sensors

Pressure &
Flow SensorsInductive
Proximity
SensorsMeasurement
SensorsIonizers/
Electrostatic
Sensors

Accessories

EX-20

IO-Link
SensorsPhotoelectric
SensorsFiber-optic
Sensors

Standard Fibers

Fiber Sensors
Communication
Units

Mark Sensors

Laser Sensors

Safety Sensors

Pressure &
Flow SensorsInductive
Proximity
SensorsMeasurement
SensorsIonizers/
Electrostatic
Sensors

Accessories

EX-30



EX-30

An alternative to fiber sensors

Features

■ An alternative to fiber sensors

The **EX-30** series can be screw-mounted (M4 for thru-beam type, M6 for reflective type). This means that they can be inserted into production lines in exactly the same way as conventional fiber sensors.

■ 800mm thru-beam type available

The sensing range is 1.5 times greater than previous models! It also has a sensitivity adjuster to enable compatibility with a wide range of applications.

■ Less power consumed!

By relentlessly developing our technologies, we have been able to considerably reduce our sensors' power consumption.

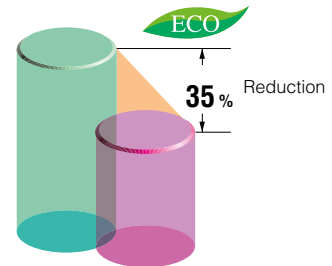

Typical applications

Detecting quantity of labels in label magazine

Detects the remaining amount of labels by the thickness of the roll.

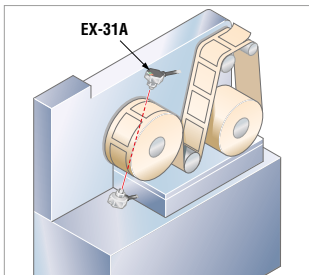

Detecting ICs

Detects whether ICs are accurately placed in IC trays.

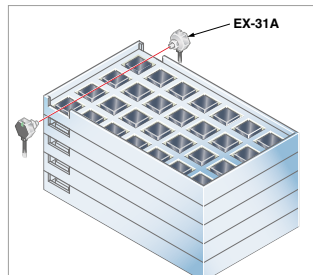

Resin bottle detection

The EX-32A threaded photoelectric sensor confirms the arrival of bottles.

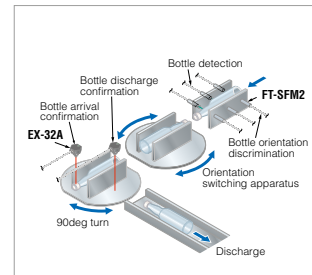

Technical specifications

Type		Thru-beam			Diffuse reflective		
Model no.	NPN output	EX-31A	EX-31B	EX-33	EX-32A	EX-32B	
	PNP output	EX-31A-PN	EX-31B-PN	EX-33-PN	EX-32A-PN	EX-32B-PN	
Sensing range		500mm			800mm	50mm	
Object to be sensed		Min. 2mm (or opaque)			Opaque, translucent or transparent object		
Supply voltage		12 to 24V DC \pm 10%					
Output		PNP / NPN open-collector transistor, max. 50mA					
Output operation		Light-ON	Dark-ON	Variable switching method	Light-ON	Dark-ON	
Response time		Max. 0.5ms					
Protection		IP67 (IEC)					
Ambient temperature		-25 to +55°C					
Connection method		Cable 2m					
Dimensions (HxWxD)		14x15.6x18mm					
Accessories		Nuts, 2 pcs.; washers, 2 pcs.			Nut, 1 pc.; washer, 1 pc.		

IO-Link
SensorsPhotoelectric
SensorsFiber-optic
Sensors

Standard Fibers

Fiber Sensors
Communication
Units

Mark Sensors

Laser Sensors

Safety Sensors

Pressure &
Flow SensorsInductive
Proximity
SensorsMeasurement
SensorsIonizers/
Electrostatic
Sensors

Accessories

EX-30

IO-Link
SensorsPhotoelectric
SensorsFiber-optic
Sensors

Standard Fibers

Fiber Sensors
Communication
Units

Mark Sensors

Laser Sensors

Safety Sensors

Pressure &
Flow SensorsInductive
Proximity
SensorsMeasurement
SensorsIonizers/
Electrostatic
Sensors

Accessories

PM-25/45/65



PM-25/45/65

Enables equipment miniaturization
and quick construction

Features

■ Increased beam emitting / receiving distance of 6mm

The beam emitting and receiving sections are 0.5mm thinner compared to our conventional models although the external dimensions have not changed. As a result, the distance between the beam-emitting and the beam-receiving point increased by 1mm. The wider distance means less possibility of collision with the object to be sensed.

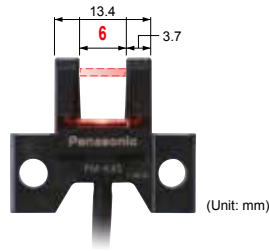

■ Beam marks for easy adjustment

There are marks on the front and back of the sensor to indicate the upper and the lower limit of the beam axis. This makes it easy to adjust the position of the object to be sensed.

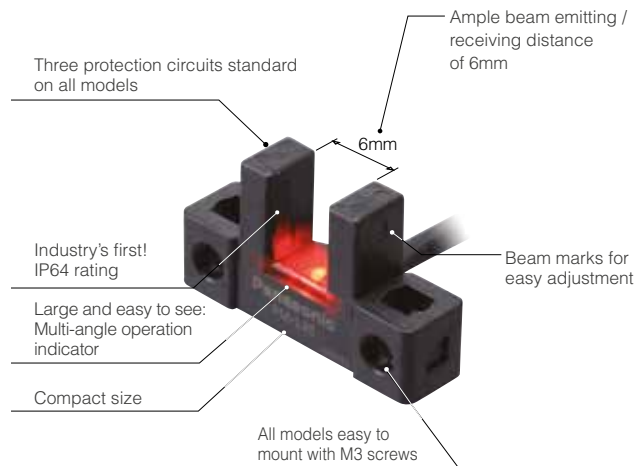

■ Large and easy-to-see operation indicator

The large operation indicator (orange) lights up when an object enters the beam axis. The indicator is easy to see from any angle – even from above and from the sides.

Typical applications

Positioning of a pallet

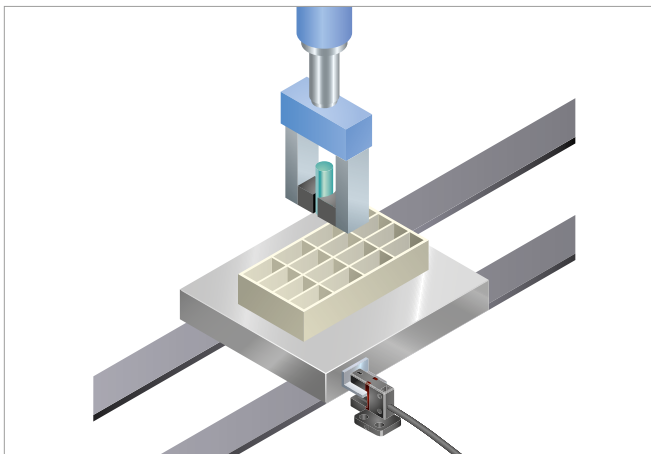

Sensing the starting point on a rotating body

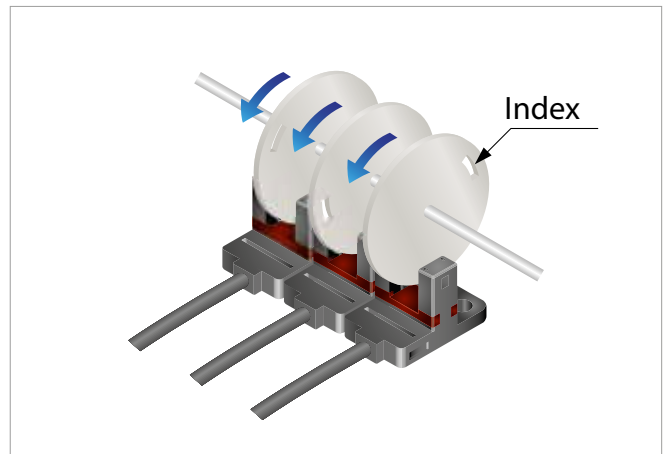

Order guide

Type	Dimensions (mm)	Model no.
K type		PM-K25
		PM-K25-P
L type		PM-L25
		PM-L25-P
F type		PM-F25
		PM-F25-P
R type		PM-R25
		PM-R25-P
U type		PM-U25
		PM-U25-P

Type	Dimensions (mm)	Model no.
K type		PM-K45
		PM-K45-P
T type		PM-T45
		PM-T45-P
L type		PM-L45
		PM-L45-P
Y type		PM-Y45
		PM-Y45-P
F type		PM-F45
		PM-F45-P
R type		PM-R45
		PM-R45-P

Type	Dimensions (mm)	Model no.
K type		PM-K65
		PM-K65-P
T type		PM-T65
		PM-T65-P
		PM-T65-W
L type		PM-L65
		PM-L65-P
Y type		PM-Y65
		PM-Y65-P
F type		PM-F65
		PM-F65-P
		PM-F65W
		PM-F65W-P
R type		PM-R65
		PM-R65-P
		PM-R65W
		PM-R65W-P

IO-Link Sensors

Photoelectric Sensors

Fiber-optic Sensors

Standard Fibers

Fiber Sensors Communication Units

Mark Sensors

Laser Sensors

Safety Sensors

Pressure & Flow Sensors

Inductive Proximity Sensors

Measurement Sensors

Ionizers/ Electrostatic Sensors

Accessories

PM-25/45/65

Technical specifications

Type		Ultra small type	Small type	
		With cable		Built-in connector
Model no. (note 1)	NPN output	PM-□25(-R) (note 2)	PM□45	PM-□65
	PNP output	PM-□25P	PM□45P	PM-□65P
Fork width		6mm (fix)		
Object to be sensed		0.8 x 1.2mm (opaque)		
Repeatability		0.01mm		
Supply voltage		5 to 24V DC ±10%		
Output		PNP / NPN open-collector transistor, max. 50mA		
Output operation		Incorporated with 2 outputs: Light-ON / Dark-ON		
Response time		Under light incident condition: max. 20μs Under light interrupted condition: max. 80μs (Response frequency: min. 3kHz)		
Ambient temperature		-25 to +55°C		
Protection		IP64 (IEC)	IP40 (IEC)	
Emitting element		Infrared LED		
Connection method		Cable, 1m	Connector (note 3)	

Notes:

- 1.) K = K type
L = L type
F = F type
R = R type
U = U type
T = T type
Y = Y type
- 2.) Suffic -R = bending-resistant cable
- 3.) Cable not included in delivery, please order separately (accessories, page 129)

IO-Link
SensorsPhotoelectric
SensorsFiber-optic
Sensors

Standard Fibers

Fiber Sensors
Communication
Units

Mark Sensors

Laser Sensors

Safety Sensors

Pressure &
Flow SensorsInductive
Proximity
SensorsMeasurement
SensorsIonizers/
Electrostatic
Sensors

Accessories

PM-25/45/65



PM2

Convergent reflection sensing
ensures stable detection

Features

■ Stable detection by convergent reflective mode

The stable detection characteristics of the **PM2** series are obtained since it is a convergent reflective type and senses a limited area. Thus regardless of the background, stable detection is possible.

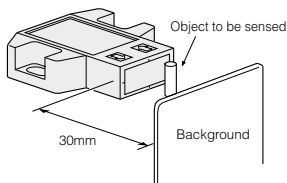

■ Not affected by background

Even a specular background does not affect the sensing performance if the sensor is located 30mm away from it (when directly opposite).

■ Dark object detectable

Since the sensor is very sensitive, it can detect even a dark object of low reflectivity.

■ Object to be sensed

A 0.05mm copper wire can be detected at a distance of 5mm.

Typical applications

Minute object detectable

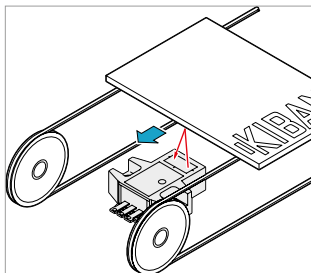

Starting point and overrun is sensed using the dog on the base

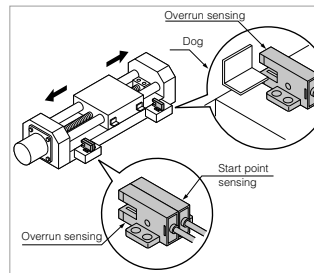

Detecting capacitors in tray

The convergent reflective type sensor reliably detects capacitors in a tray without being affected by their color, characters, marks or glossiness.

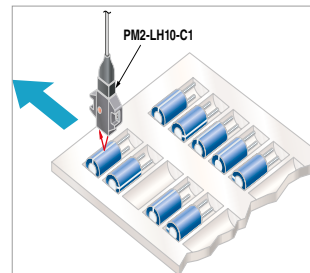

IO-Link
Sensors

Photoelectric
Sensors

Fiber-optic
Sensors

Standard Fibers

Fiber Sensors
Communication
Units

Mark Sensors

Laser Sensors

Safety Sensors

Pressure &
Flow Sensors

Inductive
Proximity
Sensors

Measurement
Sensors

Ionizers/
Electrostatic
Sensors

Accessories

PM2

Technical specifications

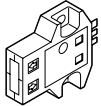
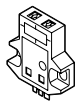
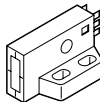
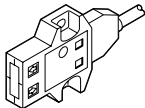
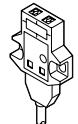
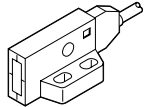
Type		Image	Model no.
Connector type	Top sensing		PM2-LH10
			PM2-LH10B
	Front sensing		PM2-LF10
			PM2-LF10B
	L type (Top sensing)		PM2-LL10
			PM2-LL10B
Cable type	Top sensing		PM2-LH10-C1
			PM2-LH10B-C1
	Front sensing		PM2-LF10-C1
			PM2-LF10B-C1
	L type (Top sensing)		PM2-LL10-C1
			PM2-LL10B-C1

Type	Connector type			Cable type			
	Top sensing	Front sensing	L type (Top sensing)	Top sensing	Front sensing	L type (Top sensing)	
Model no.	Light-ON	PM2-LH10	PM2-LF10	PM2-LL10	PM2-LH10-C1	PM2-LF10-C1	PM2-LL10-C1
	Dark-ON	PM2-LH10B	PM2-LF10B	PM2-LL10B	PM2-LH10B-C1	PM2-LF10B-C1	PM2-LL10B-C1
Sensing range	2.5 to 8mm (conv. point: 5mm) with white non-glossy paper (15x15mm)						
Object to be sensed	Min. Ø 0.05mm copper wire (setting distance: 5mm)						
Repeatability (perpendicular to sensing axis)	0.08mm						
Supply voltage	5 to 24VDC ± 10%						
Output	NPN open-collector transistor, max. 50mA						
Response time	Max. 0.8ms						
Emitting element	Infrared LED						
Connection method	Connector for soldering (note)			Cable, 1m			

Note: Cable is not included in delivery. Please select under accessories (page 129)



EQ-500

Long range sensing capability
up to 2.5m

Features

■ Impervious to variations in color or angle

Due to its advanced optical system, the sensor is not affected by variations in the object's angle or gloss as compared to conventional sensors. Moreover, sensing can be performed at a somewhat constant distance even if the sensing object is black or white.

■ Not affected by background objects

Due to the 2-segment photodiode adjustable range system, the sensor does not detect objects outside the preset sensing field. It will not malfunction even if someone walks behind the sensing object, or machines or conveyors are in the background.

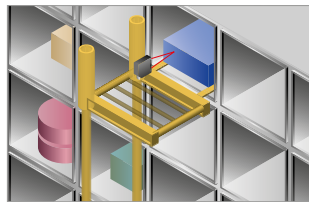

■ An easy-to-set adjuster with indicator

Equipped with a 2-turn adjuster with indicator making it easy to set for short or long distances. **EQ-500** series can function with 24 to 240V AC and 12 to 240V DC. Therefore, almost any power supply anywhere in the world will work.

■ Equipped with BGS/FGS function

We have added a DC-voltage type with NPN and PNP transistor outputs, all in one sensor. Its BGS/FGS function controls any background effects for more stable sensing.

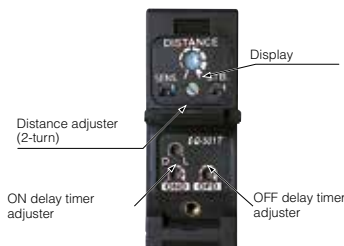

■ Convenient timer function models

Types with an ON-delay/OFF-delay timer available. (EQ-5□T)

- › Operation: ON-delay OFF-delay
- › Timer period: 0.1 to 5s (individual setting possible)

■ Little affected by contamination on lens

Even if the lens surface gets somewhat dirty from dust particles, there is very little change in the operation field, rendering stable and consistent detection even for particles appearing close to the front surface of the unit.

■ Convenient terminal block type

Cabling is enabled by way of a terminal block.

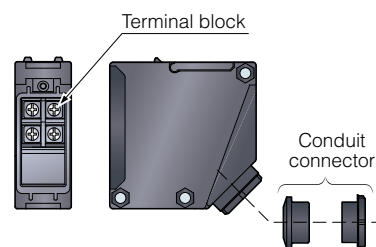

- IO-Link Sensors
- Photoelectric Sensors
- Fiber-optic Sensors
- Standard Fibers
- Fiber Sensors Communication Units
- Mark Sensors
- Laser Sensors
- Safety Sensors
- Pressure & Flow Sensors
- Inductive Proximity Sensors
- Measurement Sensors
- Ionizers / Electrostatic Sensors
- Accessories

Technical specifications

Type	Multi-voltage type				DC-voltage			
		With timer		With timer		With timer		With timer
Model no.	EQ-501	EQ-501T	EQ-502	EQ-502T	EQ-511	EQ-511T	EQ-512	EQ-512T
Sensing range	0.2 to 2.5m		0.2 to 1.0m		0.2 to 2.5m		0.2 to 1.0m	
Supply voltage	24 to 240V AC \pm 10%, or 12 to 240V DC \pm 10%				12 to 24V DC \pm 10%			
Output	Relay contact 1a 3A/250V AC				PNP / NPN open-collector transistor, max. 100mA			
Output operation	Light-ON or Dark-ON							
Response time	Max. 20ms (for EQ-50□T dependent on the setting timer period)				Max. 20ms (for EQ-51□T dependent on the setting timer period)			
Timer periods	–	Incorporated with variable ON-delay / OFF-delay timer (0.1 to 5s)	–	Incorporated with variable ON-delay / OFF-delay timer (0.1 to 5s)	–	Incorporated with variable ON-delay / OFF-delay timer (0.1 to 5s)	–	Incorporated with variable ON-delay / OFF-delay timer (0.1 to 5s)
Protection	IP67 (IEC)							
Ambient temperature	–20 to +55°C							
Emitting element	Infrared LED							
Connection method	Convenient terminal block							
Dimensions (HxWxD)	68x26x68mm							
Accessories	Screwdriver, 1 pc.							

IO-Link Sensors

Photoelectric Sensors

Fiber-optic Sensors

Standard Fibers

Fiber Sensors Communication Units

Mark Sensors

Laser Sensors

Safety Sensors

Pressure & Flow Sensors

Inductive Proximity Sensors

Measurement Sensors

Ionizers/ Electrostatic Sensors

Accessories

EQ-500



EQ-30

Unaffected by color or material,
2m distance adjustable
fixed-focus sensing

Features

- Not affected by object color or background
- Long sensing range 2m
- Compact size

The **EQ-30** saves space since a miniaturized housing of 68x20x40mm (HxWxD) has been designed.

- **Plug-in connector type**

The plug-in connector type (M12) of the EQ-30 series can be easily disconnected for replacement.

Technical specifications

Type		Diffuse
Model no.	NPN output	EQ-34 (J) (note)
	PNP output	EQ-34PN (J)
Rated sensing distance		2.0m
Sensing range		0.1-2m
Detectable target		Transparent and opaque material
Hysteresis		Max. 10% of measurement
Response time		Max. 2ms
Supply voltage		10 to 30VDC ± 10%
Output		PNP / NPN open-collector transistor, max. 100mA
Emitting element		Infrared LED
Rated current consumption without load		NPN type: 50mA PNP type: 55mA
Material		Plastic
Protection		IP67 (IEC)
Ambient temperature		-20 to +55°C
Connection method		Cable 2m or M12 connector
Dimensions (HxWxD)		68x20x40mm
Accessories		Screwdriver, 1 pc.

Note: Suffix J = M12 connector type

Typical applications

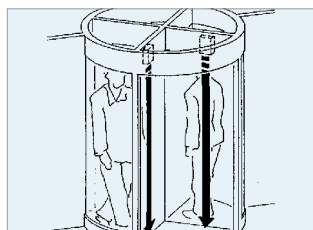

Long distance sensing

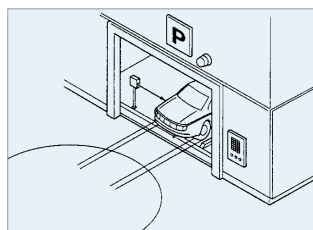

Object detection

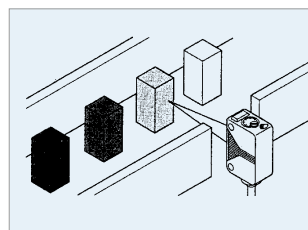

Color-independent detection

IO-Link
Sensors

Photoelectric
Sensors

Fiber-optic
Sensors

Standard Fibers

Fiber Sensors
Communication
Units

Mark Sensors

Laser Sensors

Safety Sensors

Pressure &
Flow Sensors

Inductive
Proximity
Sensors

Measurement
Sensors

Ionizers/
Electrostatic
Sensors

Accessories

EQ-30

- IO-Link Sensors
- Photoelectric Sensors**
- Fiber-optic Sensors
- Standard Fibers
- Fiber Sensors Communication Units
- Mark Sensors
- Laser Sensors
- Safety Sensors
- Pressure & Flow Sensors
- Inductive Proximity Sensors
- Measurement Sensors
- Ionizers/ Electrostatic Sensors
- Accessories



NA1-11

Cross-beam scanning system to detect slim objects

Features

■ **Letters, postcards can be detected**

Thin objects can be detected by using the cross-beam scanning system.

■ **Beam pitch: 10mm**

Object to be sensed size of $\varnothing 13.5\text{mm}$ is realized by using a beam pitch of 10mm.

■ **Long sensing range**

Though very slim, a wide sensing area of 1m length and 100mm width is realized. It is most suitable for object detection on a wide assembly line or for detecting the dropping of or incursion by small objects whose travel path is uncertain.

■ **Clearly visible large indicator**

A clearly visible large indicator having a 55mm width is incorporated on both the emitter and the receiver.

Cross-beam scanning system

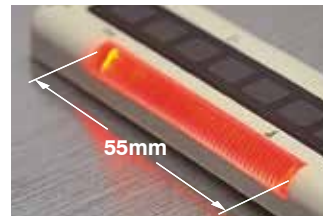
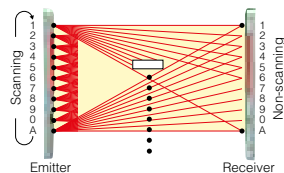

Typical applications

Detecting postcards

NA1-11 can detect thin postcards due to its crossbeam scanning system.

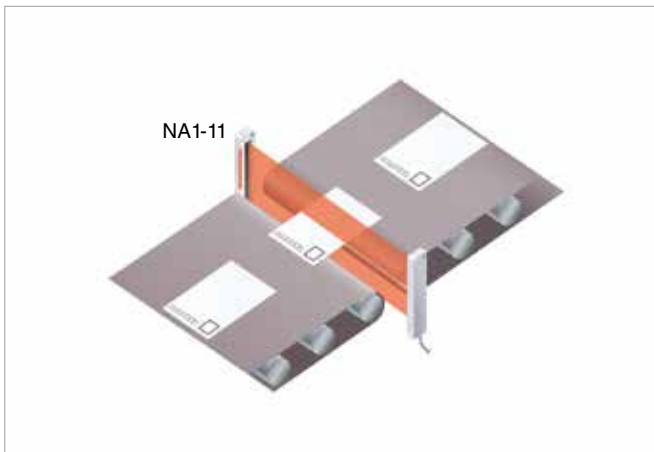

Detection of haphazardly falling objects

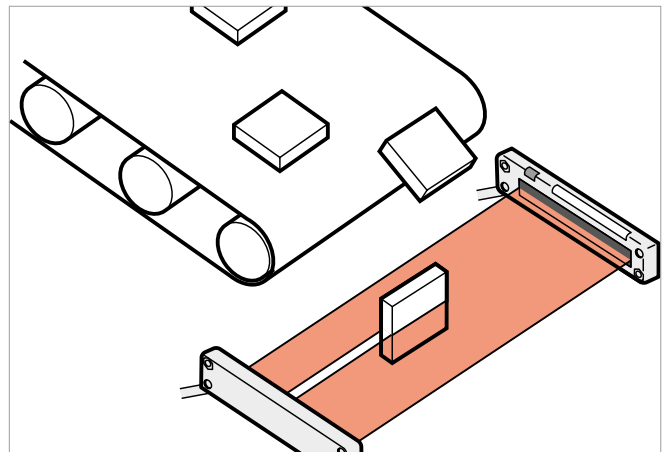

Technical specifications

Type	NPN	PNP
Model no.	NA1-11	NA1-11-PN
Sensing height	100mm	
Sensing range	0 to 1m (note)	
Beam pitch	10mm	
Numbers of beam channels	11 each on the emitter and the receiver, respectively	
Object to be sensed	Min. \varnothing 13.5mm (opaque)	
Supply voltage	12 to 24VDC \pm 10%	
Output	NPN open-collector transistor, max. 100mA	PNP open-collector transistor, max. 100mA
Ambient temperature	-10 to +55°C	
Connection method	Cable, 2m	
Dimensions (HxWxD)	140x30x10mm	

Note: Operating range for the receiver: 0.17 to 1m

- 10-Link Sensors
- Photoelectric Sensors
- Fiber-optic Sensors
- Standard Fibers
- Fiber Sensors Communication Units
- Mark Sensors
- Laser Sensors
- Safety Sensors
- Pressure & Flow Sensors
- Inductive Proximity Sensors
- Measurement Sensors
- Ionizers / Electrostatic Sensors
- Accessories

NA1-11

- IO-Link Sensors
- Photoelectric Sensors**
- Fiber-optic Sensors
- Standard Fibers
- Fiber Sensors Communication Units
- Mark Sensors
- Laser Sensors
- Safety Sensors
- Pressure & Flow Sensors
- Inductive Proximity Sensors
- Measurement Sensors
- Ionizers/ Electrostatic Sensors
- Accessories



NA1-PK5/ NA1-PK3

Pick-to-light sensor –
Ultra-slim body

Features

■ 10 mm thick: half the thickness of conventional models
Space saving now possible; ultra-thin design does not obstruct picking operations.

■ Two unit installations are possible
Sensor units can now be set to different light emission frequencies in order to prevent mutual interference.
Two units can now be operated in a side-by-side configuration without interference for problem-free detection over wide areas.



Cable can be freely arranged in any position

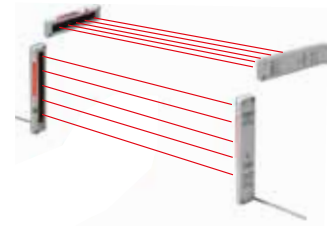

■ Lighting pattern selectable
The job indicator operation can be selected as either continuous lighting or blinking.

■ Selectable detection operation
Sensor units can be set to detect the interruption of 1 beam channel or 2 or more beam channels.

Continuous lighting

Blinking

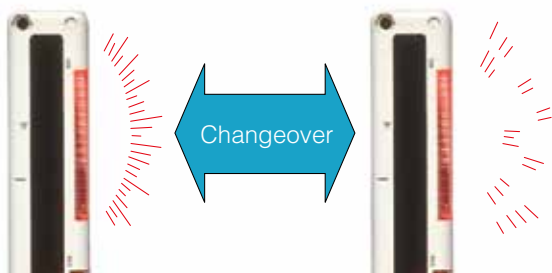

Single beam interruption

Double beam interruption

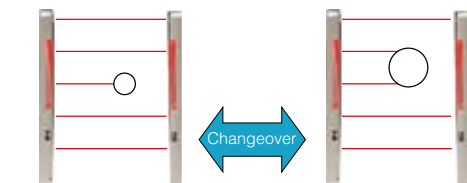

All opaque bodies with $\varnothing 35\text{mm}$ or greater will be detected.

The accidental passage of small objects through the beam axis will not trigger detection, yet the operator's hands will always be accurately detected. This function is also useful when small objects regularly interrupt the beam axis.

NA1-PK5/
NA1-PK3

Typical applications

Cell production line



Assembly line



Technical specifications

Type	NPN		PNP	
	NA1-PK5	NA1-PK3	NA1-PK5-PN	NA1-PK3-PN
Model no.	NA1-PK5	NA1-PK3	NA1-PK5-PN	NA1-PK3-PN
Sensing height	100mm	49.2mm	100mm	49.2mm
Sensing range	0.1 to 1.2m	0.03 to 0.3m	0.1 to 1.2m	0.03 to 0.3m
Beam pitch	25mm	24.6mm	25mm	24.6mm
Number of beam channels	5 beam channels	3 beam channels	5 beam channels	3 beam channels
Object to be sensed	Min. \varnothing 35mm (opaque)	Min. \varnothing 29mm (opaque)	Min. \varnothing 35mm (opaque)	Min. \varnothing 29mm (opaque)
Supply voltage	12 to 24VDC \pm 10%			
Output	NPN open-collector transistor max.100mA		PNP open-collector transistor max.100mA	
Connection method	Cable, 2m			
Dimensions (HxWxD)	140x30x10mm	70x24x8mm	140x30x10mm	70x24x8mm

IO-Link
SensorsPhotoelectric
SensorsFiber-optic
Sensors

Standard Fibers

Fiber Sensors
Communication
Units

Mark Sensors

Laser Sensors

Safety Sensors

Pressure &
Flow SensorsInductive
Proximity
SensorsMeasurement
SensorsIonizers/
Electrostatic
Sensors

Accessories

NA1-PK5/
NA1-PK3

IO-Link
SensorsPhotoelectric
SensorsFiber-optic
Sensors

Standard Fibers

Fiber Sensors
Communication
Units

Mark Sensors

Laser Sensors

Safety Sensors

Pressure &
Flow SensorsInductive
Proximity
SensorsMeasurement
SensorsIonizers/
Electrostatic
Sensors

Accessories

FX-100



FX-100

Excellent price/performance ratio

Features

■ Easy to read

The digital dual display allows you to check both the threshold value and incident light intensity at the same time. It also makes the procedures for setting the various values much easier.

■ Multipurpose M8 connector type

The connectors used are commercially available M8 connectors, so that processing costs and lead time required for carrying out processing can be greatly reduced.

■ Designed in a 3-layer structure to accommodate basic through advanced settings

Setting details are divided into three levels for clearer operation, so that settings for normal operation are made in 'RUN mode', basic settings are made in 'SET mode', and advanced functions are set in 'PRO mode'. This makes setting operations much easier to understand and carry out.

Typical applications

Wafer detection

Detects wafer carrier cases through vacuum chamber's view port.

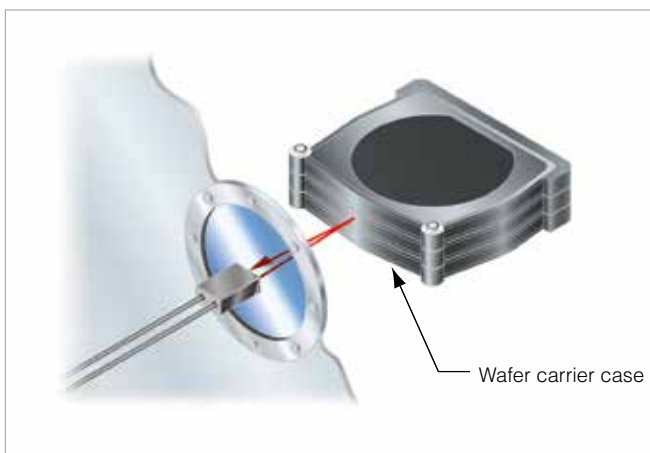

Wafer detection

Sensing possible in corrosive environment. Lenses at the ends of the fiber heads expand the sensing range.

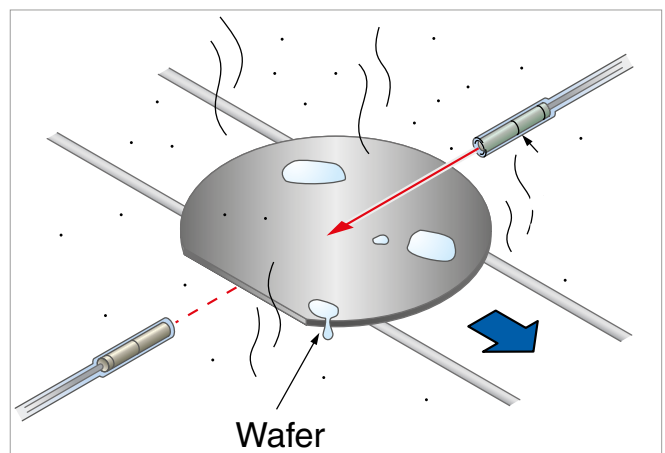

Detection of breaks / cracks of glass

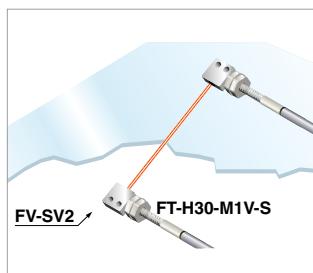

Detection over long ranges



Detection of glass substrate in vacuum chamber

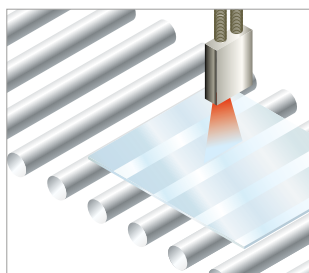

Detection of glass substrate

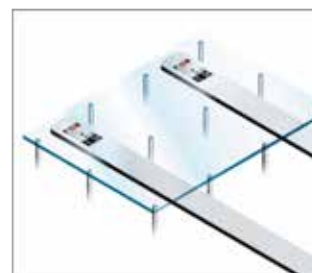

Technical specifications

Type		Standard type		Long sensing range	
		Connector type	Cable type	Connector type	Cable type
Model no.	NPN output	FX-101 (-Z) (note 2)	FX-101-CC2	FX-102 (-Z) (note 2)	FX-102-CC2
	PNP output	FX-101P (-Z) (note 2)	FX-101P-CC2	FX-102P (-Z) (note 2)	FX-102P-CC2
Supply voltage		12 to 24VDC \pm 10%			
Power consumption		Normal operation: max. 720mW (current consumption max. 30mA at 24V supply voltage) Eco mode: max. 600mW (current consumption max. 25mA at 24V supply voltage)			
Response time		Response time 0: Response time 1: Response time 2: Response time 3:	max. 250 μ s max. 450 μ s max. 500 μ s max. 600 μ s	Response time 1: Response time 2: Response time 3: Response time 4:	max. 2.5ms max. 2.8ms max. 3.2ms max. 5.0ms
Output		PNP / NPN open-collector transistor, max. 100mA			
Output operation		Selectable either Light-ON or Dark-ON			
Short-circuit protection		Incorporated			
Sensitivity setting		2-level teaching/Limit teaching/Full-auto teaching			
Digital display		4 digit green + 4 digit red LCD display			
Timer function		ON-delay /OFF-delay, switchable either effective or ineffective. [Timer period: 1ms, 5ms, 10ms, 20ms, 40ms, 50ms, 100ms, 500ms, 1000ms]			
Interference prevention		Incorporated Selectable response time method (note 1) (Functions at response time 1, 2 or 3)		Incorporated Selectable response time method (note 1) (Functions at response time 1, 2, 3 or 4)	
Ambient temperature		-10 to +55°C (if 4 to 7 units are mounted close together: -10 to +50°C; if 8 to 16 units are mounted close together: -10 to +45°C (no dew condensation or icing allowed))			
Emitting element		Red LED			
Material		Enclosure: polycarbonate; key switch: polycarbonate; fiber lock lever: PBT			
Connection method		Small connector M8 connector (note 3)	Cable, 2m	Small connector M8 connector (note 3)	Cable, 2m
Dimensions (HxWxD)		32x9x66.4mm			
Accessories		—	CN-14A-C2 (Connector attached cable: 2m): 1 pc.	—	CN-14A-C2 (Connector attached cable: 2m): 1 pc.

Notes:

- When using the interference prevention function, set the emission frequencies for the amplifiers to be covered by the interference prevention function to different frequency values. However, the interference prevention function does not operate at emission frequency 0 (factory default setting) for the **FX-101(P)(-Z)/FX-101(P)(-Z)-CC2**
- Suffix -Z = M8 connector type
- The cable is not included in delivery. Please select under accessories (page 129)

10-Link
SensorsPhotoelectric
SensorsFiber-optic
Sensors

Standard Fibers

Fiber Sensors
Communication
Units

Mark Sensors

Laser Sensors

Safety Sensors

Pressure &
Flow SensorsInductive
Proximity
SensorsMeasurement
SensorsIonizers/
Electrostatic
Sensors

Accessories

FX-100

IO-Link
SensorsPhotoelectric
SensorsFiber-optic
Sensors

Standard Fibers

Fiber Sensors
Communication
Units

Mark Sensors

Laser Sensors

Safety Sensors

Pressure &
Flow SensorsInductive
Proximity
SensorsMeasurement
SensorsIonizers/
Electrostatic
Sensors

Accessories

FX-301



FX-301

Enhanced functions
- strong performance
- easy to use

Features

■ FX-301(P) (red LED type) version upgrade

We improved the standard model by enhancing its sensing stability and equipping it with handy functions such as the light-emitting amount selection function.

■ Super high-speed response of 35 μ s

The **FX-301(P)-HS** model is the digital type fiber sensor realizing a super high-speed response of 35 μ s rendering it capable of sensing minute objects moving at high speeds.

■ Stable sensing over long and short periods

In addition to a four-chemical emitting element which suppresses changes in the light-emitting element over time so that a stable level of light emission can be maintained over long periods, a new APC (Auto Power Control) circuit has also been adopted. Because fluctuations over short periods of time have also been suppressed, stable sensing is possible very quickly once the power is turned back on after setup changes.

■ Sensing range has been greatly increased

All models use a double coupling lens that enables a much wider sensing range and maximization in the light emission efficiency. Sensing ranges with small diameter fibers and ultra small diameter fibers, which have become very popular due to the miniaturization of chip components, have been increased by 50% over previous values achieved with other amplifiers.



FX-301 series
double
coupling lens

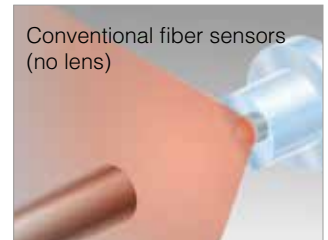

Conventional fiber sensors
(no lens)

Stable sensing comparison

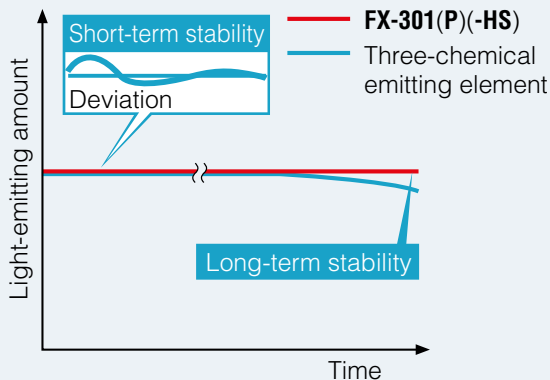

Typical applications

Workpiece detection

This standard type of FX-301(P)(-HS) using red light has a four-chemical emitting element for stable sensing over long periods.

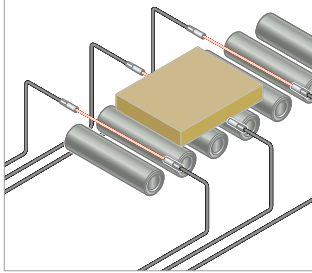

Sensing translucent stickers

The blue LED type greatly reduces the damping rate, making it ideal for delicate sensing for yellow/red transitions.

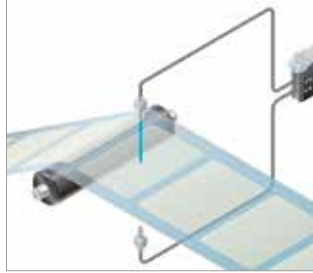

Register mark detection

The green LED type greatly reduces the damping rate, making it ideal for delicate sensing.

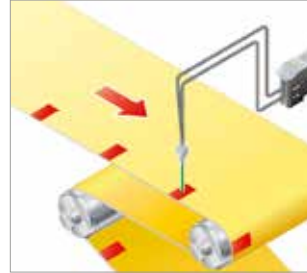

Sensing film meandering

Infrared LED type is ideal for sensing environments with light restrictions, such as places where light-sensitive film is being handled.

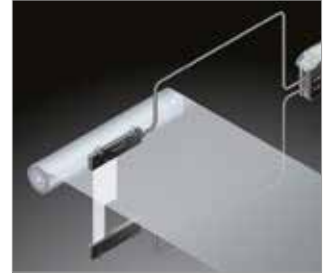

Object sensing during the painting process

Due to a sensing range of 19.5m (FX-301 long range mode) and a 10m fiber length, it can be lead through rough environments freely.



Engine block passage confirmation

FD-WKZ1 has realized a sensing range of 480mm (FX-301 long range mode). In addition, due to its powerful beam, it can even work in adverse environments such as in areas prone to dust.

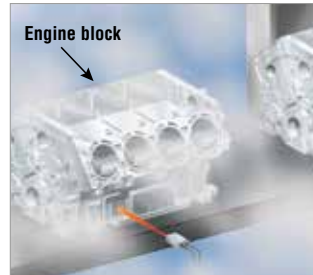

Wire breakage detection

Wide beams are ideal for moving wire detection.

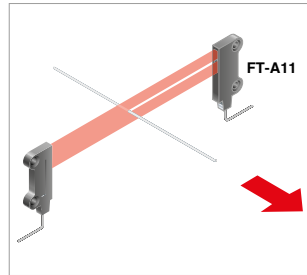

Technical specifications

Type		Standard type	High speed
Model no.	NPN output	FX-301(-B/-G/-H) (note 1)	FX-301-HS
	PNP output	FX-301(-B/-G/-H)P	FX-301P-HS
Supply voltage		12 to 24VDC ±10%	
Response time		Max. 65µs H-SP (Red LED type only); max. 150µs (FAST); max. 250µs [STD/S-D (Red LED type only)]; max. 2ms (LONG) selectable with jog switch	Max. 35µs (H-SP); max. 150µs (FAST); max. 250µs (STD/S-D); max. 2ms (LONG) selectable with jog switch
Output		PNP / NPN open-collector transistor, max. 100mA	
Output operation		Selectable either Light-ON or Dark-ON, with jog switch	
Sensitivity setting		2-level teaching/Limit teaching/ Full-auto/ teaching	
Digital display		4-digit red LED display	
Automatic interference prevention function		Incorporated (Up to 4 sets of fiber heads can be mounted close together.) (However, H-SP mode is 2 sets.)	
Ambient temperature		-10 to +55°C	
Emitting element		FX-301(P): Red LED, FX-301B(P): Blue LED, FX-301G(P): Green LED, FX-301H(P): Infrared LED	Red LED
Connection method		Connector (note 2)	
Dimensions (HxWxD)		30.5x10x64.5mm	
Accessories		FX-MB1 Amplifier protection seal	

Notes:

- Without suffix = Red LED
Suffix-B = Blue LED
Suffix-G = Green LED
Suffix-H = Infrared LED
- The cable for amplifier connection is not supplied as an accessory. Please select under accessories (page 129)

IO-Link
Sensors

Photoelectric
Sensors

Fiber-optic
Sensors

Standard Fibers

Fiber Sensors
Communication
Units

Mark Sensors

Laser Sensors

Safety Sensors

Pressure &
Flow Sensors

Inductive
Proximity
Sensors

Measurement
Sensors

Ionizers/
Electrostatic
Sensors

Accessories

FX-301

IO-Link
SensorsPhotoelectric
SensorsFiber-optic
Sensors

Standard Fibers

Fiber Sensors
Communication
Units

Mark Sensors

Laser Sensors

Safety Sensors

Pressure &
Flow SensorsInductive
Proximity
SensorsMeasurement
SensorsIonizers/
Electrostatic
Sensors

Accessories

FX-311



FX-311

Remarkably easy to use

Features

■ 12-turn potentiometer with visible indicator

12-turn potentiometer has been incorporated for fine adjustments. It enables very fine differences to be detected. Since the potentiometer is illuminated, you can even make adjustments easily in dark areas.

■ Three light source types (red, green, blue) are made available for expanding applications

Rapid blinking 'assist function' eases adjustment for optimum sensitivity.

Typical applications

Detecting transparent PET bottles

The green LED type is ideal for stably sensing objects such as transparent bottles which yield only small amounts of light fluctuation.

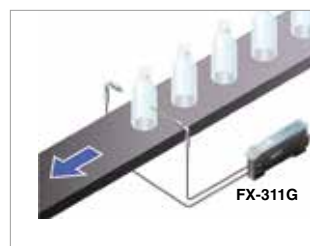

Register mark detection

The blue LED type can accurately sense yellow marks on white backgrounds that are difficult to sense using the red LED type.



Technical specifications

Model no.	NPN output	FX-311
	PNP output	FX-311P
Supply voltage	12 to 24VDC ±10%	
Power consumption	Max. 840mW (Current consumption max. 35mA at 24V supply voltage)	
Response time	Max. 250µs (STD / S-D), max. 2ms (LONG) selectable with selection switch	
Output	PNP / NPN open-collector transistor, max. 100mA	
Output operation	Selectable either Light-ON or Dark-ON, with selection switch	
Short-circuit protection	Incorporated	
Operation of indicators	Orange LED (lights up when the output is ON)	
Timer function	Incorporated with OFF-delay timer, selectable either effective (approx. 10ms or 40ms) or ineffective	
Automatic interference prevention function	Incorporated (Up to 4 sets of fiber heads can be mounted closely.) (note 1)	
Ambient temperature	-10 to +55°C (if 4 to 7 units are mounted close together: -10 to +50°C; if 8 to 16 units are mounted close together: -10 to +45°C (no dew condensation or icing allowed))	
Emitting element	Red LED	
Material	Enclosure: Heat-resistant ABS, Case cover: polycarbonate	
Connection method	Connector (note 2)	
Dimensions (HxWxD)	34.5x10x70.5mm	

Notes:

- 1.) When the power supply is switched on, the light emission timing is automatically set for interference prevention
- 2.) The cable for amplifier connection is not supplied as an accessory. Please select under accessories (page 129)



FX-500 / 550

Fiber amplifier at the industry's leading edge

IO-Link Sensors

Photoelectric Sensors

Fiber-optic Sensors

Standard Fibers

Fiber Sensors Communication Units

Mark Sensors

Laser Sensors

Safety Sensors

Pressure & Flow Sensors

Inductive Proximity Sensors

Measurement Sensors

Ionizers / Electrostatic Sensors

Accessories

FX-500/550

Features

Optimized stability

When used with the super quality fiber as a set, the incident light intensity variation among units is decreased to only 1/4 of that of conventional models.

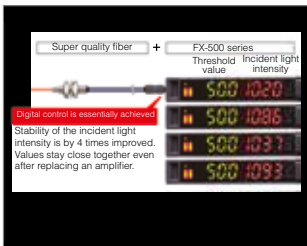

High performance

The FX-500 with its ultra high response time improves of 25µs productivity.

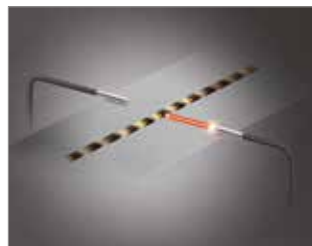

HYPER mode incorporated

FX-500 in combination with the small diameter fiber can handle challenging detections over a super long sensing range.



Improved accuracy!

FX-500 with its accurate detection catches fractional difference in light intensity, fulfilling high precision and low-hysteresis applications.

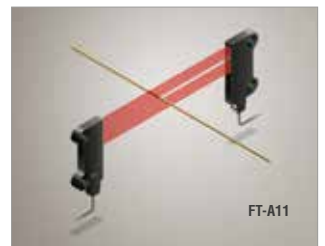

No PLC necessary, saving material and programming costs



Logical operation of sensors

Three logical calculations (AND/OR/XOR) are selectable using Output 1 of multiple FX-500 series amplifiers. You can logically connect two outputs of an FX-500 or one input of a normal sensor to the output of an FX-500 sensor.

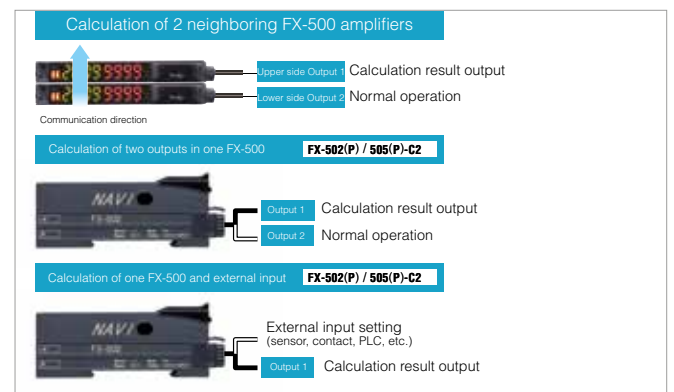

Analog output cable type FX-505

The sensor outputs an analog signal of 4-20mA in proportion to digital value displayed for the current light intensity received.

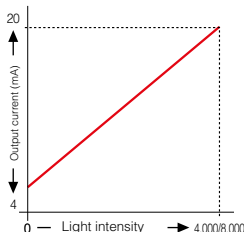

Edge tracking of film or sheet

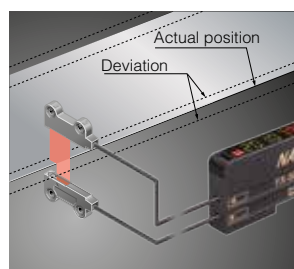

Drifting path can be tracked as the light intensity changes.

Direct settings

Direct adjustment: Threshold values can be changed directly in RUN mode.

Direct teaching: Teaching can be done in RUN mode. Just press the SET button once for object "present" and "not present".

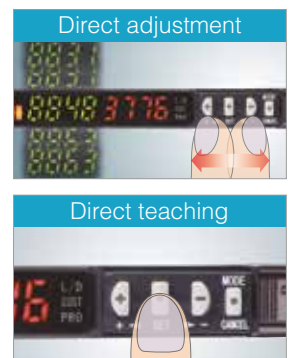

Typical applications

Counting of IC pins

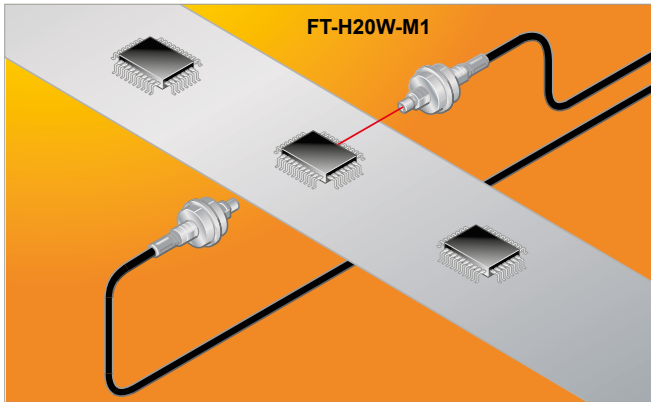

Check crimping

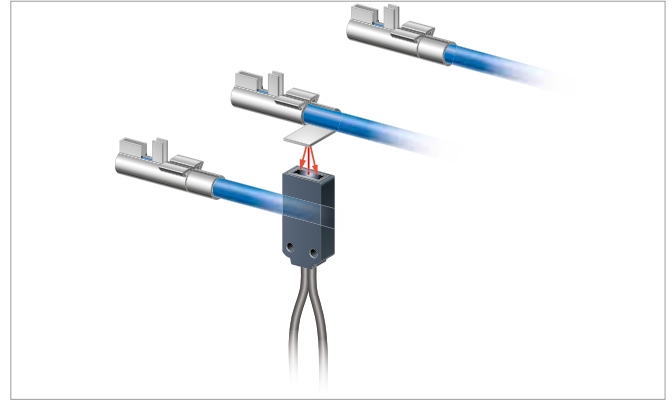

Glass substrate sensing



Technical specifications

Type	Connector			Cable		
Model no.	NPN output	FX-501	FX-502	FX-551	FX-551-C2	FX-505-C2
	PNP output	FX-501P	FX-502P	FX-551P	FX-551P-C2	FX-505P-C2
Digital fiber sensor amplifier	Digital				Analog	
Timer function	Adjustable: 0.1ms to 999.9ms in 0.1ms steps, 1 to 9999ms in 1ms steps, 1 to 32s in 1s steps					
Interference prevention	Auto interference prevention function for up to 12 units and selectable emission frequency method			Incorporated (up to 4 units)		Auto interference prevention function for up to 12 units and selectable emission frequency method
Response time	Max. 25µs/60µs/250µs/2ms/4ms/24ms			Max. 60µs/250µs/2ms/4ms/24ms		Max. 25µs/60µs/250µs/2ms/4ms/24ms
Analog voltage output	-					4 to 20mA
Supply voltage	12 to 24V DC ±10%					
Output	PNP / NPN open-collector transistor, max. 100mA					
Emitting element	Red LED					
Material	Enclosure: polycarbonate, switch: POM					
Rated current consumption (without load)	Normal operation: max. 40mA at 24V supply voltage Eco mode: max. 30mA at 24V supply voltage					
Protection	IP40 (IEC)					
Ambient temperature	-10 to +55°C					
Connection method	Connector type (note)				Cable, 2m	
Dimensions (HxWxD)	34x10x75mm					
Accessories	FX-MB1 Amplifier protection seal			-		FX-MB1 Amplifier protection seal

Note: The cable for amplifier FX-501□, FX-502□, FX-551□ is not supplied as an accessory. Please select under accessories (page 129).

Fiber-optic Sensors

Now with communication interface!



Fibers with integrated high-precision plug

IO-Link
SensorsPhotoelectric
SensorsFiber-optic
Sensors

Standard Fibers

Fiber Sensors
Communication
Units

Mark Sensors

Laser Sensors

Safety Sensors

Pressure &
Flow SensorsInductive
Proximity
SensorsMeasurement
SensorsIonizers/
Electrostatic
Sensors

Accessories

■ Stable light intensity

Optical **fibers** with insertion plug-in achieve a very high quality standard. Through the integrated high-precision plug, the fiber core can be centered to within $\pm 40\mu\text{m}$. Variation in light intensity could thus be reduced to $\pm 10\%$.



■ New fiber core

Now the core consists of only one fiber instead of several single fibers. This design improves sensing stability dramatically because there is no variation in light intensity among individual fibers.

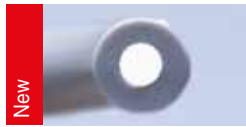

New



Old

■ Sharp bending and flexible fibers

With a bending radius of 4mm, the optical fibers easily cope with millions of bending cycles.

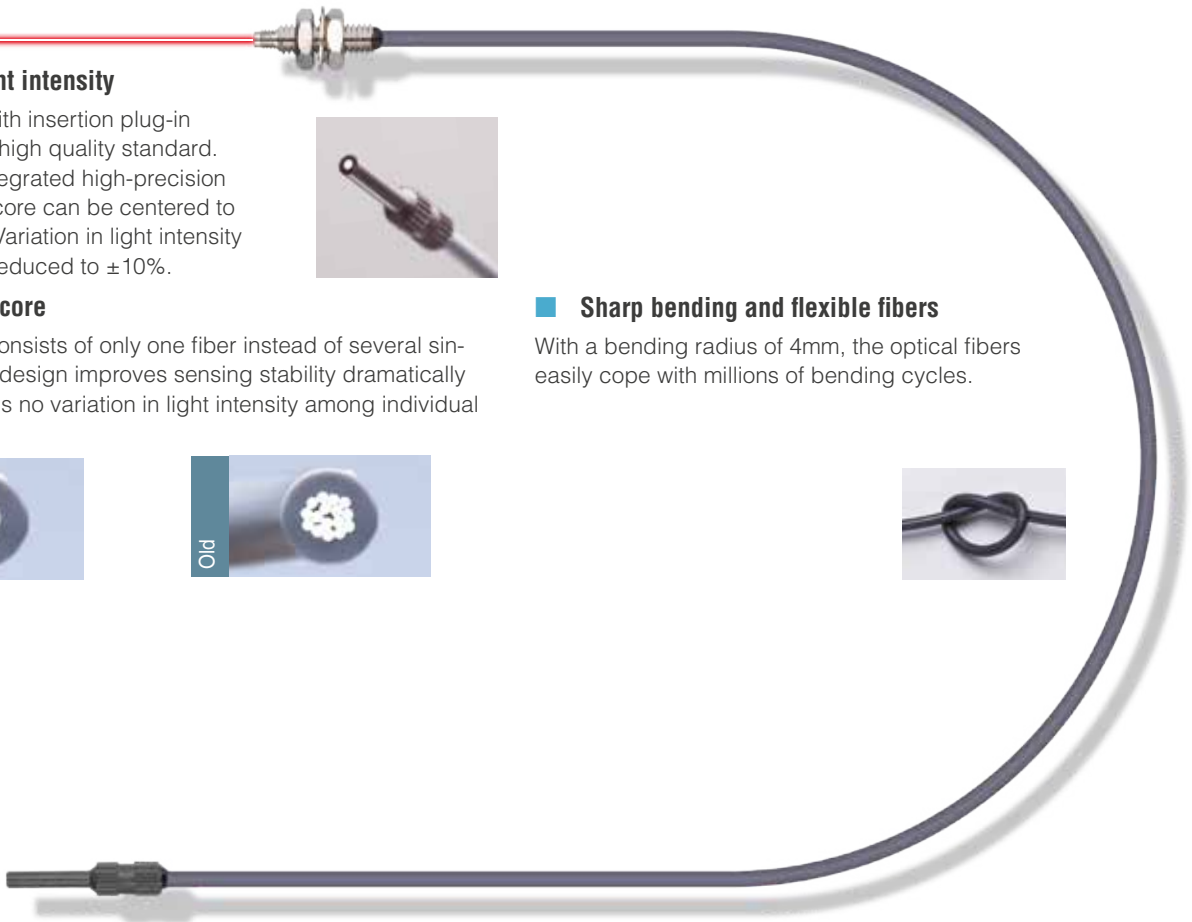
Fibers with
integrated high-
precision plug

Thru-beam type (one pair set)



Type	Shape of fiber head (mm)	Model no.	Bending radius	Fiber cable length	Sensing range (mm)			Beam axis dia. (mm)	Protection	Ambient temperature
					FX-500 series	U-LG LONG FAST H-SP	FX-101 FX-102			
Threaded	M3 	Tough FT-30	R2	2m	STD 400 HYPR 1350	810 650 210 75	135 400	∅0.5	IP67 (IEC)	-55 to +80°C
	M4 	Tough FT-40			STD 1200 HYPR (note) 3600	2200 1700 530 190	320 870			
Cylindrical	∅1.5 	Tough FT-S20	R2		STD 400 HYPR 1350	810 650 210 75	135 400	∅0.5		
	∅3 	Tough FT-S30	R4		STD 1200 HYPR (note) 3600	2200 1700 30 190	320 870			

Note: The length of the fiber cable affects the sensing range.

Reflective type

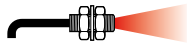

Type	Shape of fiber head (mm)	Model no.	Bending radius	Fiber cable length	Sensing range (mm) (note)			Protection	Ambient temperature
					FX-500 series	U-LG LONG FAST H-SP	FX-101 FX-102		
Threaded	M3 	Tough FD-30	R2	2m	STD 160 HYPR 600	330 250 80 25	45 155	IP67 (IEC)	-55 to +80°C
	M4 	Tough FD-40			STD 520 HYPR 1550	900 740 260 90	140 420		
	M6 	Tough FD-60							
Cylindrical	∅3 	Tough FD-S30	R4		STD 160 HYPR 600	330 250 80 25	45 155		

Note: The sensing range is specified for white, matt paper.

Tough High flexibility: min. bending radius of 4mm, 10 mio. bending cycles (@ radius 10mm)

- IO-Link Sensors
- Photoelectric Sensors
- Fiber-optic Sensors
- Standard Fibers
- Fiber Sensors Communication Units
- Mark Sensors
- Laser Sensors
- Safety Sensors
- Pressure & Flow Sensors
- Inductive Proximity Sensors
- Measurement Sensors
- Ionizers / Electrostatic Sensors
- Accessories

Fibers with integrated high-precision plug

Threaded fibers

Thru-beam type (one pair set)



Type	Shape of fiber head (mm)	Model no.	Bending radius	Fiber cable length	Sensing range (mm) (note 1)			Beam axis dia. (mm)	Protection	Ambient temperature
					FX-500 series	U-LG LONG FAST H-SP	FX-101 FX-102			
Threaded	M3	Tough FT-31	R2	2m	STD 315 HYPR 1350	770 550 210 70	130 340	ø0.5	IP67 (IEC)	-55 to +80°C
	M4	Lens mountable: FX-LE1, FX-LE2, FX-SV1 FT-43	R4		STD 1400 HYPR (note 2) 3600	2800 2100 770 240	350 970			
	Elbow	Lens mountable: FX-LE1, FX-LE2 FT-R40	R4	STD 930 HYPR (note 2) 3600	1750 1500 500 160	270 740	ø1			
	M4	Square head W7 × H9 × D13.5 FT-R43	R4	STD 720 HYPR 3000	1600 1100 430 130	210 640		ø10		
	M14	Long sensing range With expansion lens FT-140	R4	10m	STD (note 2) 19600 HYPR (note 2) 19600	19600 (note 2) 19600 (note 2) 16000 6300	14000 19600 (note 2)			

Notes:

- 1.) The sensing range of the free-cut type fiber may be reduced depending upon how the fiber is cut
- 2.) The length of the fiber cable affects the sensing range

Tough High flexibility: min. bending radius of 4mm, 10 mio. bending cycles (@ radius 10mm)

Reflective type



Type	Shape of fiber head (mm)	Model no.	Bending radius	Fiber cable length	Sensing range (mm) (note 1, 2)			Protection	Ambient temperature
					FX-500 series	U-LG LONG FAST H-SP	FX-101 FX-102		
Threaded	M3	Tough FD-31	R2	2m	STD 125 HYPR 515	290 220 80 25	35 140	IP67 (IEC)	-55 to +80°C
	M3	Coaxial • Lens mountable: FX-MR3, FX-MR6 FT-32G	R2		STD 200 HYPR 650	380 270 95 27	70 190		
	Ultra-small diameter	Lens mountable: FX-MR3, FX-MR6, Coaxial FT-EG30	R4	500mm	STD 48 HYPR 170	130 110 30 9	20 70	IP40 (IEC)	-40 to +70°C
Threaded	M4	Tough FD-41	R2	2m	STD 125 HYPR 515	290 220 80 25	35 140		
	M4	Lens mountable: FX-MR1, FX-MR2, FX-MR3, FX-MR5, FX-MR6, Coaxial FT-42G	R2		STD 200 HYPR 650	380 270 95 27	70 190	IP40 (IEC)	
Threaded	M6	Tough FD-61	R4	2m	STD 450 HYPR 1400	840 670 200 70	120 410		IP67 (IEC)
	M6	Coaxial FT-61G	R4		STD 420 HYPR 1100	800 650 200 60	120 350	IP40 (IEC)	
	Elbow	Tough FD-R60	R4	2m	STD 290 HYPR 1100	600 550 190 65	110 240		IP67 (IEC)



Notes:

- 1.) The sensing range of the free-cut type fiber may be reduced depending upon how the fiber is cut
- 2.) The sensing range is specified for white, matt paper

Tough High flexibility: min. bending radius of 4mm, 10 mio. bending cycles (@ radius 10mm)

Square head fibers

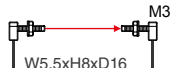

Thru-beam type (one pair set)

Type	Shape of fiber head (mm)	Model no.	Bending radius	Fiber cable length	Sensing range (mm) (note 1)			Beam axis ϕ (mm)	Protection	Ambient temperature
					FX-500 series	U-LG LONG FAST H-SP	FX-101 FX-102			
Square head	 M3 W5.5xH8xD16	Tough FT-R31	R2	 2m	STD 270 HYPR 1000	580 440 160 55	100 340	ϕ 0.5	IP67 (IEC)	-55 to +80°C
		FT-R41W	R1		STD 800 HYPR 3200	1800 1400 460 150	250 710	ϕ 1	IP40 (IEC)	-40 to +60°C
	With lens FT-R42W	STD 2200 HYPR 3600 (note 2)			3600 (note 2) 3500 1300 460	510 2000	ϕ 2.2			
	Lens mountable: FX-LE1/FX-LE2/FX-SV1 FT-R43	Tough	R4		STD 720 HYPR 3000	1600 1100 430 130	210 640	ϕ 1	IP67 (IEC)	-55 to +80°C
	Cable protection Usable with lens FT-R44Y	Tough			STD 720 HYPR 3000	1600 1100 430 130	210 640	ϕ 1	IP67 (IEC) (note 3)	-55 to +80°C
	Full protection FT-R60Y	Tough			STD 2100 HYPR 3600 (note 2)	3600 (note 2) 3600 (note 2) 1260 400	690 1890	ϕ 3.5	IP68G	-55 to +80°C

Notes:

- 1.) The sensing range of the free-cut type fiber may be reduced by 20% depending upon how the fiber is cut
- 2.) The length of the fiber cable affects the sensing range
- 3.) The fiber cable is oil-resistant

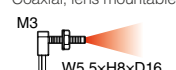
Reflective type

Type	Shape of fiber head (mm)	Model no.	Bending radius	Fiber cable length	Sensing range (mm) (note 1, 2)			Beam axis ϕ (mm)	Degree of protection	Ambient temperature
					FX-500 series	U-LG LONG FAST H-SP	FX-101 FX-102			
Square head	 M3 W5.5xH8xD16	Tough FD-R31G	R2	 2m	STD 170 HYPR 530	310 260 85 27	45 150	Emitter ϕ 0.5	IP40	-55 to +80°C
		FD-R32EG	STD 45 HYPR 170		110 92 30 9	20 68	Emitter ϕ 0.25			
	Coaxial, lens mountable FT-R34EG	R4	STD 138 HYPR 130		90 70 23 7	17 60	Emitter ϕ 0.175			
	Coaxial, lens mountable FD-R33EG		STD 119 HYPR 84		44 33 11 3	7 22	Emitter ϕ 0.125	-20 to +60°C		
	M4 W7xH9xD13.5	Tough FD-R41	R2		 2m	STD 210 HYPR 710	430 320 100 34	60 170	ϕ 0.75	IP67
M6 W10xH11xD15.5	Tough FD-R61Y	R4	TD 280 HYPR 990	610 435 160 50	85 185	-	IP67 (note 3)			

Notes:

- 1.) The sensing range of the free-cut type fiber may be reduced by 20% depending upon how the fiber is cut
- 2.) The length of the fiber cable affects the sensing range
- 3.) The fiber cable is oil-resistant

Tough High flexibility: min. bending radius of 4mm, 10 mio. bending cycles (@ radius 10mm)

IO-Link Sensors

Photoelectric Sensors

Fiber-optic Sensors

Standard Fibers

Fiber Sensors Communication Units

Mark Sensors

Laser Sensors

Safety Sensors

Pressure & Flow Sensors

Inductive Proximity Sensors

Measurement Sensors

Ionizers / Electrostatic Sensors

Accessories

Square head fibers

Cylindrical fibers

Thru-beam type (one pair set)

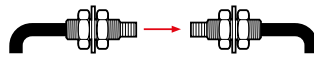

Type	Shape of fiber head (mm)	Model no.	Bending radius	Fiber cable length	Sensing range (mm) (note 1)			Beam axis dia. (mm)	Protection	Ambient temperature	
					FX-500 series	U-LG LONG FAST H-SP	FX-101 FX-102				
Cylinder	 $\phi 1$	Tough FT-S11		500mm	STD 90 HYPR 350	210 160 60 19	40 90	$\phi 0.25$	IP67 (IEC)	-55 to +80°C	
	 $\phi 1.5$	Tough FT-S21	R2	2m	STD 315 HYPR 1350	770 550 210 70	130 340	$\phi 0.5$			
	 $\phi 1.5$	FT-S21W	R1		STD 260 HYPR 990	590 440 150 53	80 240	$\phi 0.25$	-40 to +60°C		
	 $\phi 2.5$	FT-S32	R10	STD 310 HYPR (note 2) 3600	3600 (note 2) 3600 (note 2) 1800 600	1100 3000	$\phi 2$	IP40 (IEC)	-40 to +70°C		
	 $\phi 3$	FT-S31W	R1	STD 800 HYPR 3300	1900 1400 490 160	260 720	$\phi 1$	-40 to +60°C			
	Ultra-small diameter	 $\phi 0.25$ $\phi 3$	Tough FT-E13		1m	STD 15 HYPR 52	30 24 8 2	6 19	$\phi 0.125$	IP67 (IEC)	-40 to +70°C
		 $\phi 0.4$ $\phi 3$	Tough FT-E23	R2	STD 75 HYPR 270	160 125 42 13	22 80	$\phi 0.25$			
	Side sensing	 $\phi 4$	Tough FT-V40	R4	2m	STD 3500 HYPR (note 2) 3600	3600 (note 2) 3600 (note 2) 2400 850	1000 3100	$\phi 2.5$	IP50 (IEC)	-40 to +60°C

- Notes:
 1.) The sensing range of the free-cut type fiber may be reduced depending upon how the fiber is cut
 2.) The length of the fiber cable affects the sensing range

Reflective type



Type	Shape of fiber head (mm)	Model no.	Bending radius	Fiber cable length	Sensing range (mm) (note 1, 2)			Protection	Ambient temperature
					FX-500 series	U-LG LONG FAST H-SP	FX-101 FX-102		
Cylindrical	 $\phi 1.5$	Tough FD-S21	R2	1m	STD 80 HYPR 190	130 110 37 11	25 70	IP40 (IEC)	-55 to +80°C
	 $\phi 3$	Tough FD-S32	R4	2m	STD 420 HYPR 1200	790 660 220 75	120 345	IP67 (IEC)	
	 $\phi 3$	FD-S32W	R1		STD 270 HYPR 900	630 430 150 45	80 230		-40 to +60°C
	 $\phi 3$	Tough FD-S31	R2	STD 125 HYPR 515	290 220 80 25	35 140	-55 to +80°C		
	 $\phi 3$	FD-S33GW	R1	STD 150 HYPR 670	340 280 90 25	45 140	IP40 (IEC)	-40 to +60°C	
	Oil-resistant	 $\phi 5.5$	Tough FD-S60Y	R4	STD 320 HYPR 600	590 420 200 75	140 300	IP68G	-40 to +70°C
	Ultra-small diameter	 $\phi 1.5$ $\phi 0.48$	FD-E13	R4	1m	STD 12 HYPR 50	29 25 7 2	5 15	IP40 (IEC)
 $\phi 3$ $\phi 0.63$		FD-E23	STD 55 HYPR 170			120 80 30 9	20 70		

- Notes:
 1.) The sensing range of the free-cut type fiber may be reduced depending upon how the fiber is cut
 2.) The sensing range is specified for white, matt paper

Fibers with sleeve

Thru-beam type (one pair set)

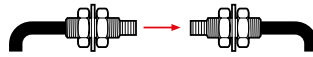

Type	Shape of fiber head (mm)	Model no.	Bending radius	Fiber cable length	Sensing range (mm) (note 1, 2)			Beam axis dia. (mm)	Protection	Ambient temperature	
					FX-500 series	U-LG LONG FAST H-SP	FX-101 FX-102				
Threaded	M3 	Tough FT-31S	R2	2m	STD 315 HYPR 1220	740 550 195 63	130 340	ø0.5	IP67 (IEC)	-55 to +80°C	
	M4 	Tough FT-42S	R4 (note 3)		STD 1130 HYPR (note 2) 3600	2050 1600 530 190	300 800				ø1
	Ultra-small 	Tough FT-E23	R2	1m	STD 75 HYPR 270	160 125 42 13	22 80	ø0.25		-40 to +70°C	
	Side sensing ø2		Tough FT-V23	R4	2m	STD 450 HYPR 1800	1000 880 280 90	160 400	ø0.75	IP30 (IEC)	-55 to +80°C
			Tough FT-V25	R2	STD 240 HYPR 900	550 480 140 45	95 260	ø0.5			
			Tough FT-V30	R4	STD 680 HYPR 2200	1200 1000 340 100	180 480	ø1.0			

Notes:

- 1.) The sensing range of the free-cut type fiber may be reduced depending upon how the fiber is cut
- 2.) The length of the fiber cable affects the sensing range
- 3.) The bending radius of the sleeve is min. 10mm

Tough High flexibility: min. bending radius of 4mm, 10 mio. bending cycles (@ radius 10mm)

Reflective type



Type	Shape of fiber head (mm)	Model no.	Bending radius	Fiber cable length	Sensing range (mm) (note 1, 2)			Protection	Ambient temperature	
					FX-500 series	U-LG LONG FAST H-SP	FX-101 FX-102			
Threaded	Ultra-small diameter M3 	FD-EG30S	R4	1m	STD 50 HYPR 170	110 80 30 9	20 70	IP40 (IEC)	-40 to +70°C	
	M4 	Tough FD-41S	R2 (note 3)	2m	STD 125 HYPR 515	290 220 80 25	35 140	IP67 (IEC)	-55 to +80°C	
	M6 	Tough FD-61S	R4 (note 3)		STD 420 HYPR 1200	790 660 220 75	130 360			
Cylindrical	Ultra-small diameter ø1.5 	FD-E13	R4	1m	STD 12 HYPR 50	29 25 7 2	5 15	IP40 (IEC)	-40 to +60°C	
	Side sensing ø3		Tough FD-V30	R2	2m	STD 65 2559 HYPR 240	130 120 35 14	25 75	IP30 (IEC)	-55 to +80°C
			Tough FD-V50	R4		STD 120 HYPR 370	220 210 75 25	40 100		

Notes:

- 1.) The sensing range of the free-cut type fiber may be reduced depending upon how the fiber is cut
- 2.) The sensing range is specified for white, matt paper
- 3.) The bending radius of the sleeve is min. 10mm

Tough High flexibility: min. bending radius of 4mm, 10 mio. bending cycles (@ radius 10mm)

IO-Link Sensors

Photoelectric Sensors

Fiber-optic Sensors

Standard Fibers

Fiber Sensors Communication Units

Mark Sensors

Laser Sensors

Safety Sensors

Pressure & Flow Sensors

Inductive Proximity Sensors

Measurement Sensors

Ionizers / Electrostatic Sensors

Accessories

Fibers with sleeve

Flat fibers

Thru-beam type (one pair set)



Type	Shape of fiber head (mm)	Model no.	Bending radius	Fiber cable length	Sensing range (mm) (note 1)			Beam axis dia. (mm)	Protection	Ambient temperature		
					FX-500 series	U-LG LONG FAST H-SP	FX-101 FX-102					
Flat	Top sensing W3 × H8 × D12	Tough FT-Z30H	R2	2m	STD 3500 HYPR (note 2) 3600	3600 (note 2) 2600 810	1400 3200	2×3	IP40 (IEC)	-40 to +60°C		
	Top sensing W3 × H8 × D12	FT-Z30HW	R1		STD 3500 HYPR (note 2) 3600	3600 (note 2) 2600 810	1400 3200					
	Side sensing W3 × H12 × D8	Tough FT-Z30E	R2		STD 3500 HYPR (note 2) 3600	3600 (note 2) 2400 740	1200 3200					
	Side sensing W3 × H12 × D8	FT-Z30EW	R1		STD 3400 HYPR (note 2) 9600	3600 (note 2) 3600 (note 2) 2000 630	1400 2600					
	Front sensing W8.5 × H12 × D3	Tough FT-Z30	R2		STD 2100 HYPR (note 2) 3600	3600 (note 2) 3600 (note 2) 1200 410	710 2300					
	Front sensing W8.5 × H12 × D3	FT-Z30W			STD 1500 HYPR (note 2) 3600	3300 3200 1000 280	540 1800					
	With boss	Front sensing W10 × H7 × D2	FT-Z20W		R1	1m	STD 530 HYPR (note 2) 1600	1100 900 330 100	230 670		ø1.5	-
		Top sensing W2 × H10 × D10	FT-Z20HBW				STD 260 HYPR 1100	670 570 180 55	100 320		ø0.5	IP67 (IEC)
		Front sensing W14 × H7 × D3.5	FT-Z40W				STD 1400 HYPR (note 2) 3500	3300 2300 890 290	330 1000		ø1.5	-
		Top sensing W3.5 × H14 × D11	FT-Z40HBW				STD 800 HYPR (note 2) 3300	1900 1400 490 160	260 720		ø1	IP67 (IEC)

Notes:
 1.) The sensing range of the free-cut type fiber may be reduced depending upon how the fiber is cut
 2.) The length of the fiber cable affects the sensing range

Reflective type



Type	Shape of fiber head (mm)	Model no.	Bending radius	Fiber cable length	Sensing range (mm) (note 1, 2)			Protection	Ambient temperature
					FX-500 series	U-LG LONG FAST H-SP	FX-101 Fx-102		
Flat	Front sensing W10 × H7 × D2	FD-Z20W	R1	1m	STD 2 to 65 HYPR 1 to 230	1 to 110 1 to 85 3 to 35 5 to 13	2 to 20 1 to 70	-	-40 to +60°C
	Top sensing W2 × H10 × D10	FD-Z20HBW			STD 2 to 85 HYPR 1 to 340	1 to 210 1 to 180 2 to 55 3 to 15	2 to 30 1 to 90	IP67 (IEC)	
	Front sensing W14 × H7 × D3.5	FD-Z40W		2m	STD 110 HYPR 430	230 180 1.5 to 65 3 to 25	1 to 55 160	-	
	Top sensing W3.5 × H14 × D11	FD-Z40HBW			STD 260 HYPR 760	540 470 1 to 160 2 to 50	1 to 90 0.5 to 240	IP67 (IEC)	

Notes:
 1.) The sensing range of the free-cut type fiber may be reduced depending upon how the fiber is cut
 2.) The sensing range is specified for white, matt paper

Tough High flexibility: min. bending radius of 4mm, 10 mio. bending cycles (@ radius 10mm)

Wide beam fibers

Thru-beam type (one pair set)



Type	Shape of fiber head (mm)	Model no.	Bending radius	Fiber cable length	Sensing range (mm) (note 1)			Beam axis dia. (mm)	Protection	Ambient temperature
					FX-500 series	U-LG LONG FAST H-SP	FX-101 FX-102			
Wide beam	Sensing width 32mm W5 × H69 × D20	Tough FT-A32	R2	2m	STD (note 2) 3600 HYPR (note 2) 3600	3600 (note 2) 3600 (note 2) 3600 (note 2) 2100	3600 (note 2) 3600 (note 2)	3.2 × 32	IP40 (IEC)	-40 to +60°C
	Sensing width 32mm W5 × H69 × D20	FT-A32W	R1		STD (note 2) 3600 HYPR (note 2) 3600	3600 (note 2) 3600 (note 2) 3000				
	Sensing width 11mm W4.2 × H31 × D13.5	Tough FT-A11	R2		STD (note 2) 3600 HYPR (note 2) 3600	3600 (note 2) 3600 (note 2) 3600 (note 2) 1100	1700 (note 2) 3400 (note 2)	-40 to +70°C		
	Sensing width 11mm W4.2 × H31 × D13.5	FT-A11W	R1		STD (note 2) 3600 HYPR (note 2) 3600	3600 (note 2) 3600 (note 2) 3600 (note 2) 1300			2.2 × 11	-40 to +55°C
Array	Sensing width 5.5mm W5 × H15 × D15	Tough FT-AL05	R2	STD 860 HYPR 2300	1550 1500 50 170	250 660	0.25 × 5.5			

Notes:

- 1.) The sensing range of the free-cut type fiber may be reduced depending upon how the fiber is cut
- 2.) The length of the fiber cable affects the sensing range

Reflective type



Type	Shape of fiber head (mm)	Model no.	Bending radius	Fiber cable length	Sensing range (mm) (note 1, 2)			Protection	Ambient temperature
					FX-500 series	U-LG LONG FAST H-SP	FX-101 FX-102		
Wide beam	W7 × H15 × D30	Tough FD-A16	R4	2m	STD 200 HYPR cannot use	200 200 140 75	120 240	IP40 (IEC)	-40 to +60°C
Array	W5 × H20 × D20	Tough FD-AL11	R2		STD 320 HYPR 670	530 510 180 50	100 285		

Notes:

- 1.) The sensing range of the free-cut type fiber may be reduced depending upon how the fiber is cut
- 2.) The sensing range is specified for white, matt paper

Tough High flexibility: min. bending radius of 4mm, 10 mio. bending cycles (@ radius 10mm)

IO-Link
Sensors

Photoelectric
Sensors

Fiber-optic
Sensors

Standard Fibers

Fiber Sensors
Communication
Units

Mark Sensors

Laser Sensors

Safety Sensors

Pressure &
Flow Sensors

Inductive
Proximity
Sensors

Measurement
Sensors

Ionizers/
Electrostatic
Sensors

Accessories

Wide beam
fibers

Convergent reflective fibers for glass detection

Reflective type



Type	Shape of fiber head (mm)	Model no.	Bending radius	Fiber cable length	Sensing range (mm) (note 1, 2)			Protection	Ambient temperature
					FX-500 series	U-LG LONG FAST H-SP	FX-101 FX-102		
Glass substrate detection	Side sensing W25 x H7.3 x D30	FD-L32H	R4	4m	STD 0 to 56 HYPR 0 to 110	0 to 87 0 to 74 1 to 38 Cannot use	16 to 30 0 to 50	IP40 (IEC)	-40 to +60°C
	Long sensing range W20 x H29 x D3.8	Tough FD-L30A	R2	3m	STD 0 to 43 HYPR 0 to 43	0 to 43 0 to 43 0 to 42 0 to 29	0 to 40 0 to 50		0 to +70°C
	Long sensing range W23.5 x H29 x D4.5	Tough FD-L31A	R4		STD 4 to 33 HYPR 3 to 35	4 to 33 4 to 33 4 to 32 5 to 25	5 to 30 4 to 33		
	Long sensing range W17 x H29 x D3.8	Tough FD-L22A	R2	2m	STD 0 to 24 HYPR 0 to 31	0 to 28 0 to 27 0 to 24 0 to 18	0 to 19 0 to 25		0 to +70°C
	Short sensing range W18 x H29 x D3.8	Tough FD-L23		3m	STD 0 to 29 HYPR 0 to 30	0 to 30 0 to 30 0 to 28 1.5 to 24	0 to 28 0 to 30		-20 to +70°C
	Short sensing range W12 x H19 x D3	Tough FD-L11	R4	2m	STD 0 to 9.5 HYPR 0 to 11.5	0 to 10.5 0 to 10 0 to 9 0 to 8	0 to 8 0 to 9		-40 to +60°C
	Short sensing range W12 x H19 x D3	Tough FD-L10			STD 0 to 5 HYPR 0 to 6	0 to 5.5 0 to 5.5 0 to 4.5 0 to 4	0 to 4.5 0 to 5.5		
	Short sensing range W24 x H21 x D4	Tough FD-L21			STD 1.5 to 16 HYPR 1 to 19	1 to 18 1 to 18 2 to 15 3 to 12	3 to 15 1.5 to 16		
	Short sensing range W24 x H21 x D4	FD-L21W	R1	STD 3 to 14 HYPR 1.5 to 15	2 to 15 2 to 15 4 to 14 6.5 to 10	7 to 12 3 to 14	-40 to +70°C		
	Short sensing range W6 x H18 x D14	Tough FD-L20H	R2	STD 23 HYPR 45	35 32 2 to 15 5 to 9	5 to 15 1 to 30			
Ultra-small	 W7.2 x H7.5 x D2	FD-L12W	R1	1m	STD 8 HYPR 14	12.5 12 0.5 to 7 0.5 to 4	1 to 4.5 0.5 to 7	IP30 (IEC)	-40 to +60°C

Notes:

- The sensing range specified for transparent glass 100x100x0.7mm (FD-L32H: edge, FD-L21 and FD-L21W: 12mm), (FD-L20H: white non-glossy paper, FD-L10: silicon wafers 100x100x2mm)
- The sensing range of the free-cut type fiber may be reduced depending upon how the fiber is cut

Retroreflective type



Type	Shape of fiber head (mm)	Model no.	Bending radius	Fiber cable length	Sensing range (mm) (note 1, 2)			Protection	Ambient temperature
					FX-500 series	U-LG LONG FAST H-SP	FX-101 FX-102		
With polarizing filter	W5.2 x H9.5 x D16 W30 x H30 x D0.5	FR-Z50HW	R1	2m	STD 100 to 990 HYPR 100 to 1900	100 to 1400 100 to 1200 100 to 780 100 to 490	100 to 550 100 to 830	IP40 (IEC)	-25 to +55°C
Side sensing	W7.5 x H2.2 x D11.2 W4 x H2 x D21.5	Tough FR-KZ22E	R2		STD 15 to 310 HYPR 15 to 570	15 to 460 15 to 410 15 to 220 15 to 100	15 to 200 15 to 360		
Narrow view Top sensing	W5.2 x H9.5 x D21 W10.6 x H28 x D10.1	Tough FR-KZ50H			STD 20 to 300 HYPR 20 to 1000	20 to 800 20 to 400 20 to 200 20 to 200	20 to 200 20 to 350		
Narrow view Side sensing	W9.5 x H25 x D5.2 W28 x H10.6 x D10.1	Tough FR-KZ50E							

Notes:

- The sensing range of the free-cut type fiber may be reduced depending upon how the fiber is cut
- The sensing range is specified for the reflector

Tough High flexibility: min. bending radius of 4mm, 10 mio. bending cycles (@ radius 10mm)

Heat-resistant fibers

Thru-beam type (one pair set)

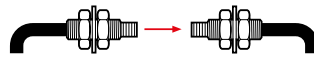

Type	Temperature	Shape of fiber head (mm)	Model no.	Bending radius	Fiber cable length	Sensing range (mm) (note 1)			Beam axis dia. (mm)	Ambient temperature	
						FX-500 series	U-LG LONG FAST H-SP	FX-101 FX-102			
Heat-resistant fiber	350°C	Lens mountable: FX-LE1/LE2/SV1 	FT-H35-M2	R25	2m	STD 430 HYPR 1200	880 670 250 80	170 490	ø1.2	-60 to +350°C	
	200°C	Lens mountable: FX-LE1/LE2/SV1 	FT-H20W-M1	R10	1m	STD 470 HYPR (note 2) 1600	1,000 840 300 90	100 300	ø0.8	-60 to +200°C	
	130°C	Lens mountable: FX-LE2 	FT-H13-FM2	R25	 2m	STD 700 HYPR 3300	1900 1300 410 140	250 700	ø1.5	-60 to +130°C	
Heat-resistant (joint)	200°C	Lens mountable: FX-LE1/LE2/SV1 	FT-H20-J20-S (note 5)	Heat resistant R18 (note 4)	 200mm (note 3)	STD 470 HYPR 1600	1000 790 300 90	135 420	ø1.2	-60 to +200°C	
			FT-H20-J30-S (note 5)		 300mm (note 3)						
			FT-H20-J50-S (note 5)		 500mm (note 3)						
		Side sensing 	FT-H20-VJ50-S (note 5)		 800mm (note 3)						STD 600 HYPR 2100
			FT-H20-VJ80-S (note 5)								

- Notes:
- 1.) The sensing range of the free-cut type fiber may be reduced depending upon how the fiber is cut
 - 2.) The length of the fiber cable affects the sensing range
 - 3.) The fiber length of the heat-resistant side cannot be cut
 - 4.) Bending radius R=25mm or more
 - 5.) Heat-resistant side and ordinary temperature fiber are sold together as a set

Reflective type



Type	Temperature	Shape of fiber head (mm)	Model no.	Bending radius	Fiber cable length	Sensing range (mm) (note 1, 2)			Ambient temperature	
						FX-500 series	U-LG LONG FAST H-SP	FX-101 FX-102		
Heat-resistant fiber	Threaded	Coaxial M6 	FD-H35-M2	R25	2m	STD 260 HYPR 720	540 460 150 45	75 280	-60 to +350°C	
		Coaxial M6 	FD-H20-M1		1m	STD 330 HYPR 840	550 500 200 55	120 300	-60 to +200°C	
		M6 	FD-H13-FM2		 2m	STD 350 HYPR 880	640 600 200 65	100 280	-60 to +130°C	
	Glass substrate detection convergent reflective	300°C			FD-H30-L32	2m	STD 17 HYPR 40	30 25 12 1.5 to 6	2 to 9 0 to 17	-60 to +300°C
		250°C			FD-H25-L45	3m	STD 5 to 42 HYPR 4 to 43.5	4 to 43 4.5 to 43 5 to 40 6.5 to 34	7 to 35 7 to 38	(-20 to +250°C Standard fibers -20 to +70°C)
		180°C			FD-H18-L31	 2m	STD 16 HYPR 60	32 24 13 2 to 6.5	0 to 10 0 to 25	-60 to +180°C

- Notes:
- 1.) The sensing range is specified for white, matt paper (50x50mm, glass substrate: **FD-H30-L32**, **FD-H18-L31**, clear glass 100x100x0.7mm: **FD-H25-L43** and **FD-H25-L45**)
 - 2.) The length of the fiber cable affects the sensing range

IO-Link Sensors

Photoelectric Sensors

Fiber-optic Sensors

Standard Fibers

Fiber Sensors Communication Units

Mark Sensors

Laser Sensors

Safety Sensors

Pressure & Flow Sensors

Inductive Proximity Sensors

Measurement Sensors

Ionizers / Electrostatic Sensors





Accessories

Heat-resistant fibers

Chemical-resistant fibers

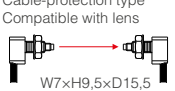
Thru-beam type (one pair set)

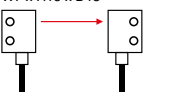

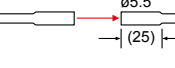
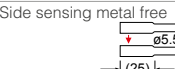
Type	Shape of fiber head (mm)	Model no.	Bending radius	Fiber cable length	Sensing range (mm) (note 1)			Beam axis dia. (mm)	Protection	Ambient temperature	
					FX-500 series	U-LG LONG FAST H-SP	FX-101 FX-102				
Oil-resistant Square head M4	Cable-protection type Compatible with lens  W7xH9.5xD15.5	FT-R44Y	R4	2m	STD 720 HYPR 3000	1600 1100 430 130	210 640	ø1	IP67 (note 4)	-55 bis +80°C	
	Side sensing  W10xH11xD21,2	FT-R60Y			STD 2100 HYPR (note 2) 3600	3600 3600 1.260 400	690 1.890				
Chemical-resistant Flat	SEMI W7 x H15 x D13 	FT-Z802Y	R25		STD 3100 HYPR (note 2) 3600	3600 (note 2) 3600 (note 2) 1900 470	520 3100		IP68G	0 to +60°C	
	Heat-resistant 115°C  ø5.5 (25)	FT-HL80Y	R30	2m (note 3)	STD (note 2) 3600 HYPR (note 2) 3600	3600 (note 2) 3600 (note 2) 2300 740	990 2340	ø3.7		IP68G	-40 to +115°C
	 ø5.5 (25)	FT-L80Y			STD (note 2) 3600 HYPR (note 2) 3600	3600 (note 2) 3600 (note 2) 2800 920	1.100 2.600				ø2.8
Side sensing metal free  ø5.5 (25)	FT-V80Y	STD 1300 HYPR 800 (note 2) 3600			2800 2200 800 240	340 800					

Notes:

- 1.) The sensing range of the free-cut type fiber may be reduced depending upon how the fiber is cut
- 2.) The length of the fiber cable affects the sensing range
- 3.) The allowable cutting range is 500mm from the end inserted at the amplifier
- 4.) The fiber is oil-resistant

Vacuum-resistant fibers

Thru-beam type (one pair set)

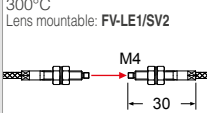

Type	Shape of fiber head (mm)	Model no.	Bending radius	Fiber cable length	Sensing range (mm)			Beam axis dia. (mm)	Ambient temperature
					FX-500 series	U-LG LONG FAST H-SP	FX-101 FX-102		
Vacuum-resistant Thru-beam type	300°C Lens mountable: FV-LE1/SV2  M4 30	FT-H30-M1V-S (note)	R18	1m	STD 27 HYPR 1000	590 470 160 55	110 280	ø1.2	-30 to +300°C

Note: Sold as a set comprising vacuum type fiber and photo-terminal (FV-BR1)

Reflective type



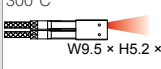
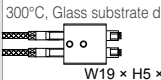







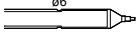

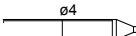
Type	Shape of fiber head (mm)	Model no.	Bending radius	Fiber cable length	Sensing range (mm) (note 2)			Ambient temperature
					FX-500 series	U-LG LONG FAST H-SP	FX-101 FX-102	
Vacuum-resistant Reflective type	300°C  W9.5 x H5.2 x D15	FD-H30-KZ1V-S (note 1)	R18	1m	STD 20 to 200 HYPR 5 to 500	10 to 340 15 to 270 20 to 120 20 to 45	25 to 80 10 to 220	-30 to +300°C
	Convergent reflective  W19 x H5 x D27	FD-H30-L32V-S (note 1)			3m	STD 8 HYPR 18	12 10 5,5 1.5 to 3	

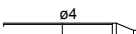
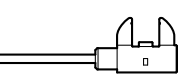
Notes:

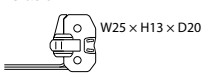
- 1.) Sold as a set comprising vacuum type fiber and photo-terminal (FV-BR1)
- 2.) The sensing range is specified for transparent glass 100x100x0.7mm

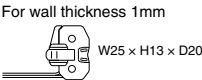
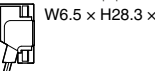
Fibers for liquid leak/liquid detection

Type	Shape of fiber head (mm)	Model no.	Bending radius	Fiber cable length	Description	Protection	Ambient temperature	
Contact type	Liquid level sensing	Heat resistant 125°C Fluorine resin coating 	FD-F8Y	Protective tube R40 Standard fibers R15	 2m (note)	ø6mm Protective tube: Fluorine resin, Length 1m (not cuttable) Liquid surface not contacted: beam received Liquid surface contacted: no beam received	IP68 (IEC)	-40 to +125°C
		Heat resistant 105°C Fluorine resin coating 	FD-HF40Y	Protective tube R20 Standard fibers	 2m	ø4mm Protective tube: Fluorine resin, Length 500mm (not cuttable) Liquid surface not contacted: beam received Liquid surface contacted: no beam received	IP67 (IEC)	-40 to +105°C
		Heat resistant 70°C Fluorine resin coating 	FD-F41Y	R10				-40 to +70°C
Pipe-mountable type	Liquid leak detection	SEMI S2 W20xH30xD10 	Tough FD-F71	Protective tube R20 Standard fibers R4	 5m	Liquid leak detection Leak absent: beam received Leak present: no beam received		-20 to +60°C
	Liquid level sensing	Default 	FD-F41	R10	 2m	Applicable pipe diameter: Outer dia.: ø6mm to ø26mm Material: transparent pipe, PFA (fluorine resin, polycarbonate, acrylic, glass) Wall thickness: 1 to 3mm Liquid absent: beam received Liquid present: no beam received	-	-40 to +100°C
		For wall thickness 1mm 	FD-F4			Applicable pipe diameter: Outer dia.: ø6mm to ø26mm Material: transparent pipe, PFA (fluorine resin). Wall thickness: 1mm. Liquid absent: beam received Liquid present: no beam received		
	Liquid sensing	Mountable on pipe W6.5 x H28.3 x D17 	Tough FD-FA93	R4		Applicable pipe diameter: Outer dia.: ø8mm or more (When used with the tying bands: ø8mm to ø80mm) Material: transparent pipe, PFA (fluorine resin). Liquid absent: beam received Liquid present: no beam received	IP40 (IEC)	-40 to +70°C
		SEMI S2 W23 x H20 x D17 	Tough FT-F93	Protective tube R20 Standard fibers R2		Applicable pipe diameter: Outer dia.: ø3mm to ø10mm Material: transparent pipe, PFA (fluorine resin). Wall thickness: 0.3 to 1mm Liquid absent: beam received Liquid present: no beam received		-40 to +60°C

Note: The allowable cutting range is 500mm from the end inserted at the amplifier

Tough High flexibility: min. bending radius of 4mm, 10 mio. bending cycles (@ radius 10mm)

Accessories

- RF-003 (Reflector for FR-KZ21/KZ21E)
- RF-13 (Reflective tape for reflective type)
- FX-CT1 (Fiber cutter)
- FX-CT2 (Fiber cutter)
- FX-CT3 (Fiber cutter)
- FX-AT2 (Attachment for fixed-length fiber, Orange)
- FX-AT3 (Attachment for ø2.2mm fiber, Clear orange)
- FX-AT4 (Attachment for ø1mm fiber, Black)
- FX-AT5 (Attachment for ø1.3mm fiber, Gray)
- FX-AT6 (Attachment for ø1mm / ø1.3mm fiber, Black/Gray)

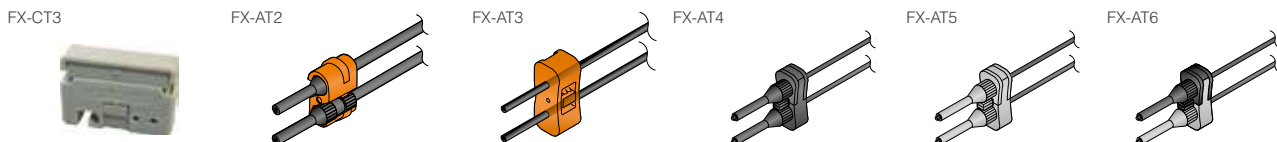
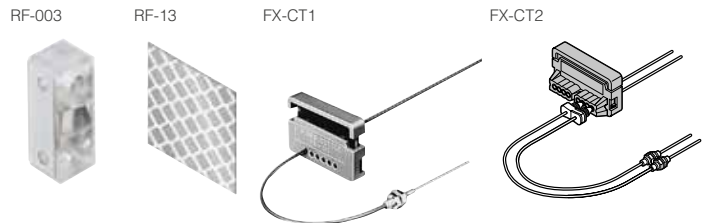

10-Link Sensors

Photoelectric Sensors

Fiber-optic Sensors

Standard Fibers

Fiber Sensors Communication Units

Mark Sensors

Laser Sensors

Safety Sensors

Pressure & Flow Sensors

Inductive Proximity Sensors

Measurement Sensors





Ionizers / Electrostatic Sensors

Accessories

Fibers for liquid leak detection

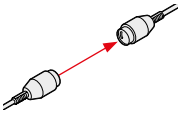
Lens

Thru-beam type fiber

Model no.	Picture	Description	Applicable fibers
FX-LE1		Expansion lens increases the sensing range by 5 times or more, ambient temperature: -60 to +350°C (note 1, 2)	FT-43, FT-42, FT-42W, FT-45X, FT-R40, FT-R43, FT-H35-M2, FT-H20W-M1, FT-H20-M1, FT-H20-J50-S, FT-H20-J30-S, FT-H20-J20-S
FX-LE2		Expansion lens increases the sensing range by 6 times or more, ambient temperature: -60 to +350°C (note 1, 2)	
FX-SV1		Side-view lens, beam axis is bent by 90°, ambient temperature: -60 to +300°C (note 1, 2)	
FV-LE1		Expansion lens for vacuum fiber increases the sensing range by 4 times or more, ambient temperature: -60 to +350°C (note 1, 2)	FT-H30-M1V-S
FV-SV2		Vacuum resistant side-view lens, beam axis is bent by 90°, ambient temperature: -60 to +300°C (note 1, 2)	

Notes:

- 1.) Consider the ambient temperature of the fibers to be used in combination
- 2.) Please test the functionality after mounting the lenses

Reflective type fiber

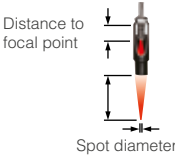
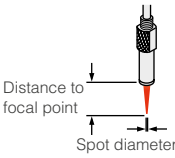
Model no.	Picture	Description	Applicable fibers
FX-MR1		Pinpoint spot lens, distance to focal point 6±1mm, spot diameter Ø 0.5mm, ambient temperature -40 to +70°C (note 1, 2)	FD-42G, FD-42GW
FX-MR2		Zoom lens, screw-in depth (7-14mm), distance to focal point (18.5- 43mm), spot diameter Ø 0.7-2mm, ambient temperature: -40 to +60°C (note 1, 2)	
FX-MR3		Extremely fine spot, distance to focal point: 7.5±0.5mm, spot diameter: FD-EG31 Ø 0.15mm/ FD-EG30 Ø 0.3mm/ FD-42G, FD-42WG, FD-32G, FD-32GX Ø 0.5, ambient temperature: -40 to +70°C (note 1, 2)	FD-EG31, FD-EG30, FD-42G, FD-42GW, FD-32G, FD-32GX

Notes:

- 1.) Consider the ambient temperature of the fibers to be used in combination
- 2.) Please test the functionality after mounting the lenses



Communication units

Communications units for flexible solutions

Functions

Function handy for startup and maintenance

Using a PLC or PC, this communication unit not only facilitates inputs (teaching, bank switching) to a digital fiber sensor e.g. FX-301(P), but also received-light amount and output status verifications greatly enhance workability during startup and maintenance.

Intuitive integration at the controller level

Rapid integration at the controller level enables reliable monitoring, remote maintenance or remote control via open networks. Several units can be configured with minimal wiring efforts. Data can be saved centrally, where it can be archived or used for evaluation purposes.



Combining different units

The ability to combine different sensor types, e.g. laser sensors, pressure sensors or digital fiber-optic sensors, opens up many application areas, especially for special purpose machinery manufacture. The sensors themselves communicate with each other via an infrared interface.



- IO-Link Sensors
- Photoelectric Sensors
- Fiber-optic Sensors
- Standard Fibers
- Fiber Sensors Communication Units
- Mark Sensors
- Laser Sensors
- Safety Sensors
- Pressure & Flow Sensors
- Inductive Proximity Sensors
- Measurement Sensors
- Ionizers / Electrostatic Sensors
- Accessories



LX-100

Introducing the 3-LED mark sensor

Functions

■ Equipped with 3 LEDs: red, green and blue

To detect any marking, this sensor is equipped with red, green and blue LED light emitting elements all in one. In addition, it uses a coaxial reflective optics system and realizes high precision sensing when used with a 1/4000 resolution 12-bit A/D converter.



■ 2 selectable sensing modes for any application

Mark mode: This sensing mode automatically selects a single color from the 3 R-G-B LEDs to realize an ultra quick 45 μ s response time. The automatic optimal LED selection function automatically selects the LED that is most suitable for the sensing. This function is perfect for ultra quick sensing.

Color mode: All 3 R-G-B LEDs light up and high precision mark color discrimination occurs using the R-G-B reflective light ratio. This function enables effective detection of films with patterns around the areas of the mark.

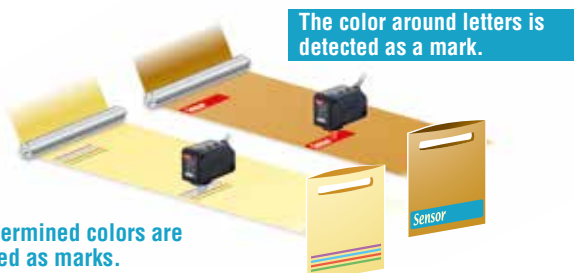

■ Even beginners can quickly master MODE NAVI operation

The sensor's basic operations are represented by 6 indicator lamps (MODE NAVI). The user can check what mode the sensor is presently in with a quick glance rendering operation simple.

Sensing status digitally controllable

The sensing status, displayed numerically, can be verified at a glance. Also, the sensor settings for each type of packing film can be digitally indicated.

Direct codes enable settings verification at a glance

The settings for the LX-100 series sensors are displayed using a 4-digit direct code. Direct codes enable easy settings verification and maintenance by phone.

Super simple teaching

Teaching (setting the threshold value) is simple, even in "Mark Mode" or "Color Mode". In addition, because teaching via an operation panel or other external input device is also possible, models can be easily interchanged.

Compact design for significant space savings

Cable and plug-in connector types are available depending on the equipment used. These sensors can be easily integrated into already existing systems.

Typical applications

Tube positioning

Detects printed marks to align tubes.

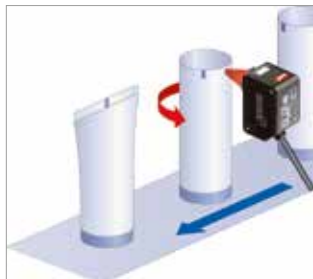

Mark detection

Mark detection of packaging film.

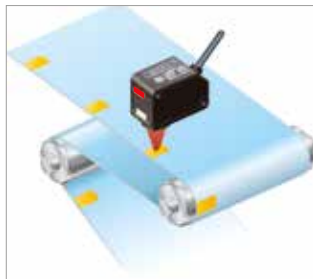

Technical specifications

Type		Cable	M12 plug-in connector type
Model no.	NPN output	LX-101	LX-101-Z (note 1)
	PNP output	LX-101-P	LX-101-P-Z
Sensing range	10±3mm		
Power supply	12 to 24VDC ±10%		
Output	2 x NPN or 2 x PNP open-collector transistor; max. 50mA		1 x NPN or 1 x PNP open-collector transistor; max. 100mA
Output operation	Mark mode: Light-ON/Dark-ON (auto-setting on teaching) Color mode: Consistent-ON/Inconsistent-ON (setting on teaching)		
Response time	Mark mode: max. 45µs; color mode: max. 150µs		
Sensitivity setting	Mark mode: 2-level teaching/Limit teaching; Color mode: 1-level teaching		
Protection	IP67 (IEC)		
Ambient temperature	-10 to +55°C		
Emitting element	Combined red/green/blue LED (Peak emission wave length: 640nm/525nm/470nm)		
Connection method	Cable 2m		M12 connector (note 2)
Dimensions (HxWxD)	35×24×57mm		35×24×71.5mm
Accessories	M4 screws with washers, 2 pcs.		

Notes:

- 1.) Suffix -Z=M12 connector type
- 2.) Cable is not included in delivery. Please select under accessories (page 129)

Photoelectric
Sensors

Fiber-optic
Sensors

Standard Fibers

Fiber Sensors
Communication
Units

Mark Sensors

Laser Sensors

Safety Sensors

Pressure &
Flow Sensors

Inductive
Proximity
Sensors

Measurement
Sensors

Ionizers/
Electrostatic
Sensors

Accessories

LX-100

IO-Link
SensorsPhotoelectric
SensorsFiber-optic
Sensors

Standard Fibers

Fiber Sensors
Communication
Units

Mark Sensors

Laser Sensors

Safety Sensors

Pressure &
Flow SensorsInductive
Proximity
SensorsMeasurement
SensorsIonizers/
Electrostatic
Sensors

Accessories

EX-L200



EX-L200

Miniature laser sensor with
a built-in amplifier!

Features

■ Minute object sensing type EX-L211 (thru-beam)

The beam of the **EX-L200** series is purposely widened to have a lower beam density and little beam spread so that when detecting minute objects, even a slight change in the light received intensity will not be missed.

■ Minute detection (reflective)

With a repeatability of 0.02mm the sensor is perfectly suited for positioning tasks.

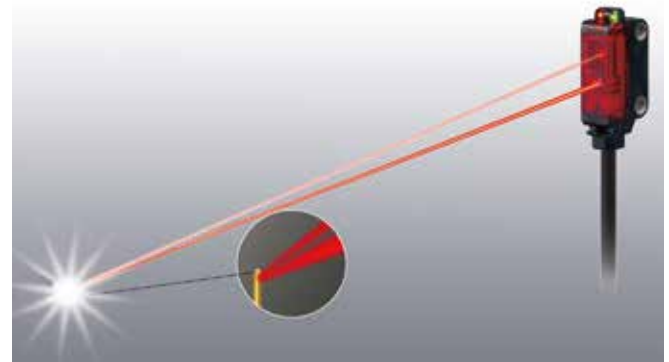
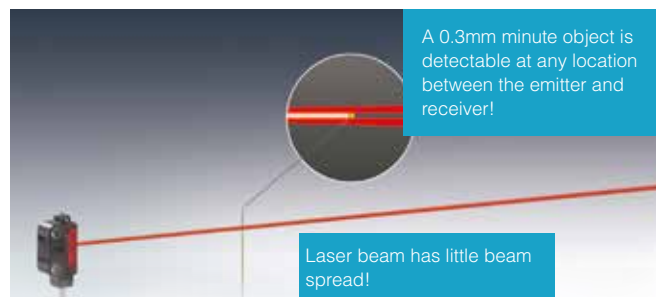

■ Environmental resistance

Thanks to the IP67 casing, the sensor is suitable for installation in humid and dusty environments.



■ Easy alignment

Beam alignment is carried out by looking at the red spot reflected on the beam alignment screen to match with the actual object. The optimum position can be understood at a glance by looking at the beam alignment screen and stability indicator (green).

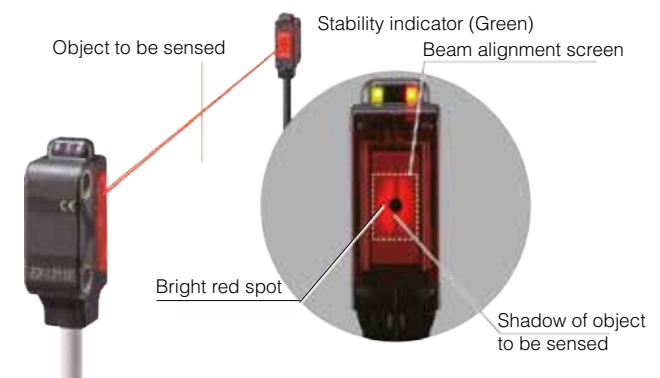

Easy adjustment by reflecting the shadow of the detection object.

Typical applications

Detecting ICs that are out of position in multiple palettes

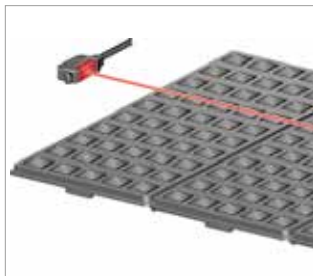

Detecting the tip of a very thin pipe



Detecting objects from an opening

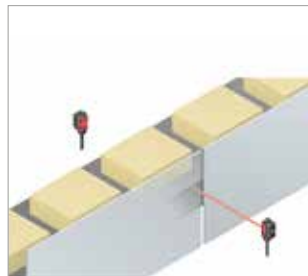

Detecting very small objects

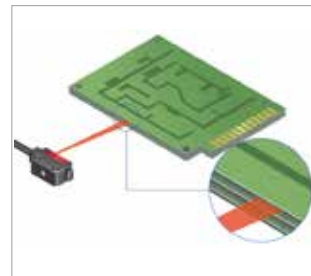

Technical specifications

Type		Thru-beam type		Retro reflective type	Diffuse reflective type		
					Spot reflective	Convergent reflective spot	Convergent reflective line spot
Model no.	NPN output	EX-L211	EX-L212	EX-L291	EX-L221	EX-L261	EX-L262
	PNP output	EX-L211P	EX-L212P	EX-L291P	EX-L221P	EX-L261P	EX-L262P
Sensing range		1m	3m	4m	45 to 300mm	20 to 50mm	20 to 70mm
Emission spot size		6x4mm at 1m	8x5.5mm at 1m	6x4mm at 1m	Ø 1mm at 300mm	Ø 1mm at 50mm (convergent point: 22mm)	1x5mm at 50mm (convergent point: 22mm)
Object to be sensed		Ø 2mm (opaque)	Ø 3mm (opaque)	Ø 25mm (opaque)	Opaque, transparent		
Power supply voltage		12 to 24V DC ±10%					
Output		PNP / NPN open-collector transistor, max. 50mA					
Response time		Max. 0.5ms					
Emitting element		Red semiconductor laser (class 1)					
Protection		IP67 (IEC)					
Ambient temperature		-10 to +55°C					
Material		Enclosure: PBT, front cover: acrylic; lenses: glass					
Connection method		Cable, 2m					
Dimensions (HxWxD)		25.9x 8.2x12mm		29.9x8.2x13mm		29.9x8.2x13.5mm	
Accessories		Mounting plates MS-EXL2-2 2 pcs.		Reflector RF330, mounting plate MS-EX-L2-3 1 pc.		Mounting plate MS-EX-L2-3 1 pc.	

IO-Link Sensors

Photoelectric Sensors

Fiber-optic Sensors

Standard Fibers

Fiber Sensors Communication Units

Mark Sensors

Laser Sensors

Safety Sensors

Pressure & Flow Sensors

Inductive Proximity Sensors

Measurement Sensors

Ionizers / Electrostatic Sensors

Accessories

EX-L200

IO-Link
SensorsPhotoelectric
SensorsFiber-optic
Sensors

Standard Fibers

Fiber Sensors
Communication
Units

Mark Sensors

Laser Sensors

Safety Sensors

Pressure &
Flow SensorsInductive
Proximity
SensorsMeasurement
SensorsIonizers/
Electrostatic
Sensors

Accessories

LS-400



Features

■ 4 types of identically sized sensor heads available

They are approximately the same size as general purpose photoelectric sensors, and the mounting method is identical.

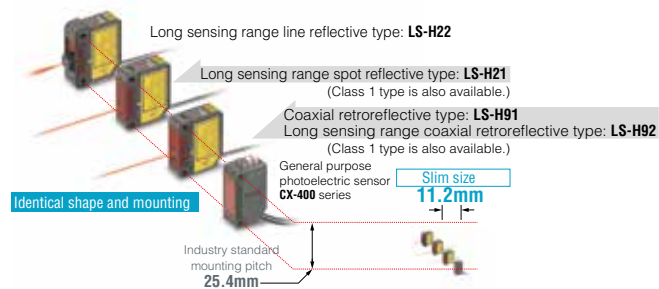

■ Coaxial reflective type with a long sensing range of 30m

The introduction of the LS-H92 long sensing range coaxial reflective type sensor means that even longer sensing ranges are now possible.

■ Spot size adjustment

The long sensing range spot reflective type and long sensing range line reflective type have a built-in spot-size adjuster that enables spot size adjustment according to the object for optimal setting.

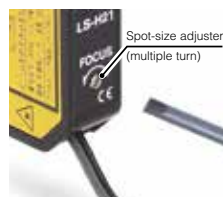

LS-400

User-friendly, advanced high precision laser sensing!

■ Accurately senses the minutest variations

When sensing at close range or when the target objects are transparent or minute, adjust the sensor receiving sensitivity to one of 3 levels for the optimal setting. In addition, changing the receiving sensitivity will not affect the response time.

■ Easy setting, dual display

Equipped with 2 large 4-digit digital displays. While checking the current light-receiving amount (red display), the optimal threshold value (green display) can be set easily.



■ Wiring and space savings

The quick-connection cables enable reductions in wiring (connector type). The connections and man hours for the intermediate terminal block setup can be reduced and valuable space saved. Also LS-400 series amplifiers can be connected side-by-side with FX-300/FX-500 series fiber sensors.

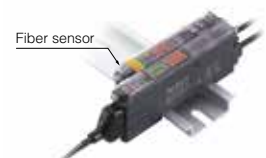

Typical applications

Interference prevention

The automatic interference prevention function protects against interference among up to 4 sensors.

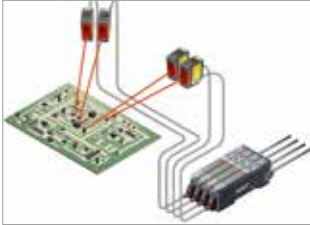

Emission halt function

Using the emission halt function, the laser beam can be stopped via external input, e.g. when a spot appears within the visual range of an image processor.

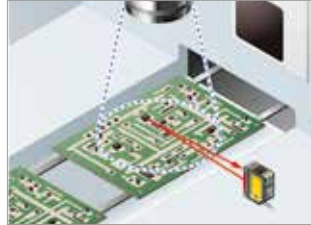

External teaching function

Teaching can be conveniently performed externally for laser sensors installed inside a device.



IC pin check from remote position

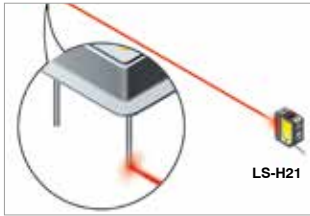

Checking protrusion of glass substrate



Technical specifications

■ Sensor heads

Type	Coaxial retroreflective		Diffuse reflective	
	Standard	Long sensing range type	Long sensing range spot-reflective	Long sensing range line reflective
Model no. (note 1)	LS-H91(F) (-A) (note 2)	LS-H92(F)	LS-H21(F) (-A) (note 2)	LS-H22(F) (note 3)
Sensing range	0.1 to 7m (U-LG) 0.1 to 5m (STD) 0.1 to 3m (FAST/H-SP)	0.2 to 30m (U-LG) 0.2 to 20m (STD) 0.2 to 10m (FAST/H-SP)	30 to 1.000mm (U-LG) 30 to 500mm (STD) 30 to 300mm (FAST/H-SP)	30 to 1.000mm (U-LG) 30 to 500mm (STD) 30 to 300mm (FAST/H-SP)
Ambient temperature	-10 to +55°C			
Emitting element	Red semiconductor laser, LS-H□ : Laser class 2, LS-H□-A : Laser class 1,			
Dimensions (W×H×D)	11.2×31×25mm			
Accessories	Reflector RF-330 1 pc., warning label (English) 1 pc.	Reflector RF-230 1 pc., warning label (English) 1 pc.	Warning label (English) 1 pc.	LS-MR1 Lens attachment for line reflective 1 pc., warning label (English) 1 pc.

Notes:

- 1.) **LS-Hx** conforms to IEC/JIS/GB standards
LS-HxF conforms to FDA/IEC/JIS standards
- 2.) **LS-H91(F)-A**, **LS-H21(F)-A**: Class 1 type
- 3.) **LS-H22(F)** = **LS-H21(F)** with the **LS-MR1** lens attachment for line reflective type

■ Amplifiers

Type	Connector type (note)	Cable type
Model no.	NPN output	LS-401
	PNP output	LS-401P
Power supply voltage	12 to 24VDC ±10%	
Output	PNP / NPN open-collector transistor, max. 100mA	
Output operation	Selectable either Light-ON or Dark-ON, with jog switch	
Response time	max. 80μs (H-SP), max. max. 150μs (FAST), max. 500μs (STD), max. 4ms (U-LG), selectable with jog switch	
Digital display	4 digit (green) and 4 digit (red) LED display	
Automatic interference prevention function	Incorporated (up to four sets of sensor heads can be mounted close together; however disabled when in H-SP mode)	
Ambient temperature	-10 to +55°C (If 4 to 7 sensors are mounted close together: -10 to +50°C) (If 8 to 16 sensors are mounted close together: -10 to +45°C)	
Connection method	Connector (note)	Cable, 2m
Dimensions (W×H×D)	10×30×75mm	

Note: The cable for amplifier connection is not supplied as an accessory with the connector type amplifier. Please select under accessories (page 129)

IO-Link
Sensors

Photoelectric
Sensors

Fiber-optic
Sensors

Standard Fibers

Fiber Sensors
Communication
Units

Mark Sensors

Laser Sensors

Safety Sensors

Pressure &
Flow Sensors

Inductive
Proximity
Sensors

Measurement
Sensors

Ionizers/
Electrostatic
Sensors

Accessories

LS-400

IO-Link
SensorsPhotoelectric
SensorsFiber-optic
Sensors

Standard Fibers

Fiber Sensors
Communication
Units

Mark Sensors

Laser Sensors

Safety Sensors

Pressure &
Flow SensorsInductive
Proximity
SensorsMeasurement
SensorsIonizers/
Electrostatic
Sensors

Accessories

LS-500

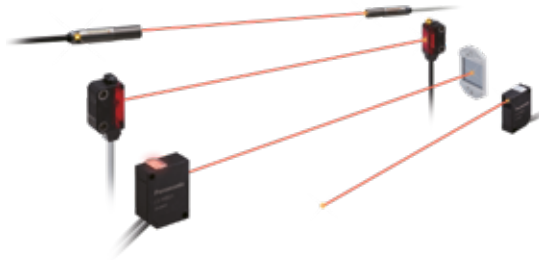

LS-500

Miniature laser head with
user-friendly amplifier

Features

■ Different sensor heads available

The **LS-500** series of laser sensors offers four different laser heads. Select the appropriate shape of the heads depending on the requirements of your application.

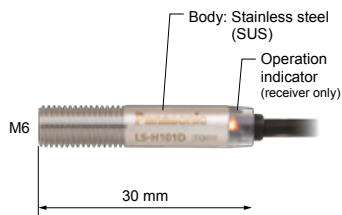

■ Robust sensor head

The robust sensor head is made of stainless steel and can be used under rough mounting conditions. The type with M6 screws is mountable even in the smallest spaces. You can check immediately with the LED indicator at the receiver whether the light is received correctly.

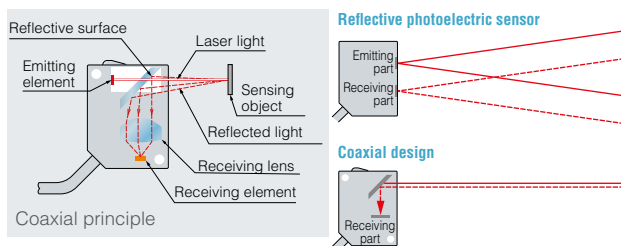

■ Highest precision

With the help of the coaxial precise light direction, the object sensing can be executed even through smallest openings. With a beam diameter of max. 6mm the retroreflective type has a sensing range of up to 2.5m.

■ Multifunctional amplifier

The LS-500 series amplifier with its clearly laid-out display offers a user-friendly design. The definition of settings, such as the adjustment of threshold values, database and logic functions, is quite simple. The model with the analog current output provides a comfortable reading out of measurement values.

■ Easy to combine

Due to its design and the possibility to mount the sensor on a DIN rail, the LS-500 can be connected quickly and easily to other sensors such as fiber amplifiers or pressure sensors.

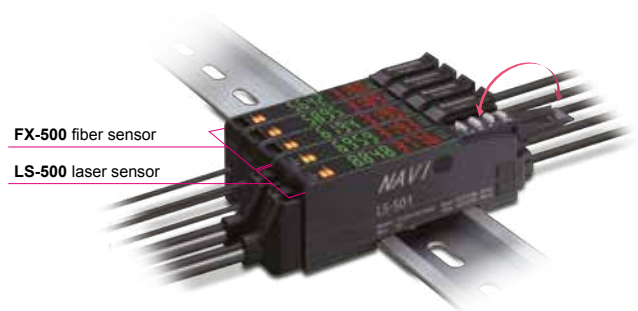

Typical applications

Position control of a workpiece

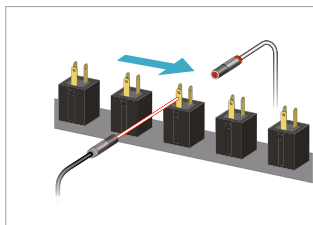

Detecting marks in a mold

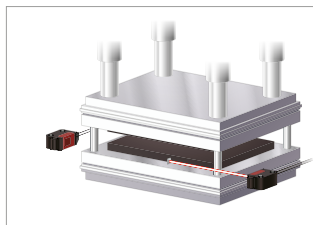

Detecting workpieces through a worktop

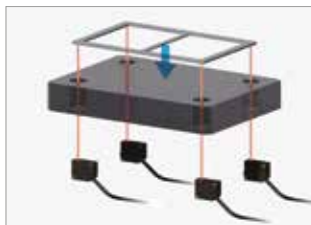

Detection of a transparent foil

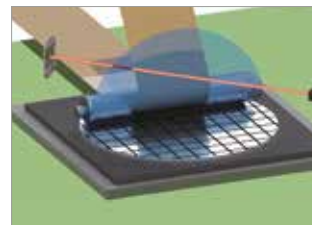

Technical specifications

Sensor heads

Type	Thru-beam		Coaxial reflective type	Coaxial retroreflective type
	Cylindrical	Rectangular	-	-
Model no.	LS-H101	LS-H102	LS-H201	LS-H901
Sensing range	1m	1m	600mm (U-LG), 300mm (STD), 150mm (H-SP)	0.01 to 2m (U-LG), 0.01-1m (STD), 0.01-1m (H-SP)
Ambient temperature	-10 to +55°C			
Emitting element	Red semiconductor laser (laser class 1)			
Dimensions (ØxD)/(HxWxD)	M6x30mm	8.2x26x12mm	6.4x24x18mm	
Accessories	M6 screws, 4 pcs., washer, 2 pcs.	MS-EXL2-2 (mounting plate) 2 pcs.	MS-LS-1 (mounting bracket) 1 pc.	MS-LS-1 (mounting bracket) 1 pc. RF-330 (reflector) 1 pc.

Amplifiers

Type		Connector type (note)	Cable type
Model no.	NPN output	LS-501	LS-501-C2
	PNP output	LS-501P	LS-501P-C2
Supply voltage	12 to 24V DC+10/-15%		
Output	PNP/NPN open-collector transistor, max. 50mA		
Analog output	-	4 to 20mA	
Output operation	Selectable either Light-ON or Dark-ON		
Response time	Max. 60µs (H-SP), 150µs (FAST), 250µs (STD), 500µs (LONG), 5ms (U-LG), 24ms (HYPR)		
Digital display	4 digit, dual LED display (green and red)		
Automatic interference prevention function	Built-in (up to 4 sensors: STD, LONG, U-LG, H-SP; up to 2 sensors: FAST; 0 sensors: HYPR)		
Ambient temperature	-10 to +55°C (if 4 to 7 units are mounted close together: -10 to +50°C, if 8 to 16 units are mounted close together: -10 to 45°C)		
Connection method	Connector (note)	2m cable	
Dimensions (HxWxD)	10x32x77mm		

Note: Cable is not included in delivery. Please select under accessories (page 129)

- IO-Link Sensors
- Photoelectric Sensors
- Fiber-optic Sensors
- Standard Fibers
- Fiber Sensors Communication Units
- Mark Sensors
- Laser Sensors
- Safety Sensors
- Pressure & Flow Sensors
- Inductive Proximity Sensors
- Measurement Sensors
- Ionizers / Electrostatic Sensors
- Accessories

LS-500

IO-Link
SensorsPhotoelectric
SensorsFiber-optic
Sensors

Standard Fibers

Fiber Sensors
Communication
Units

Mark Sensors

Laser Sensors

Safety Sensors

Pressure &
Flow SensorsInductive
Proximity
SensorsMeasurement
SensorsIonizers/
Electrostatic
Sensors

Accessories

SF4D



SF4D

Typ 4 · PLe · SIL3

Robust safety light curtain

Features

■ Easy installation of emitter and receiver thanks to improved optical properties

Thanks to a higher emission power, the **SF4D** not only works reliably on shorter distances, but also covers a longer sensing range up to 15m.

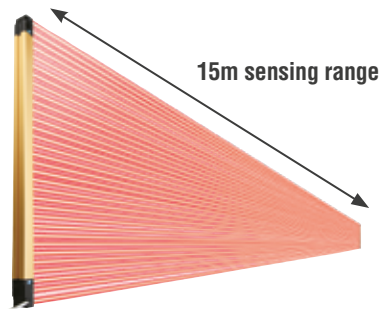

■ Twisting- and bending-resistant design

The new interior design makes the safety light curtain more rigid and thus more robust. The SF4D does not bend or twist as easily when it comes into contact with other objects.



Resists twisting



Resists bending



Resists shock

■ Main functions

- › Operation monitoring
 - » Monitoring of the incident beam intensity and extraneous light
 - » I/O monitoring
- › Error history display
- › Light blockage history, unstable light incidence history
- › Muting setting function
- › Override setting function
- › Blanking setting function (both fixed and floating blanking)
- › External device monitoring setting function
- › Auxiliary output setting functions

Which functions are available depends on the synchronization method and the type of cables (5-core, 8-core, 12-core) used.

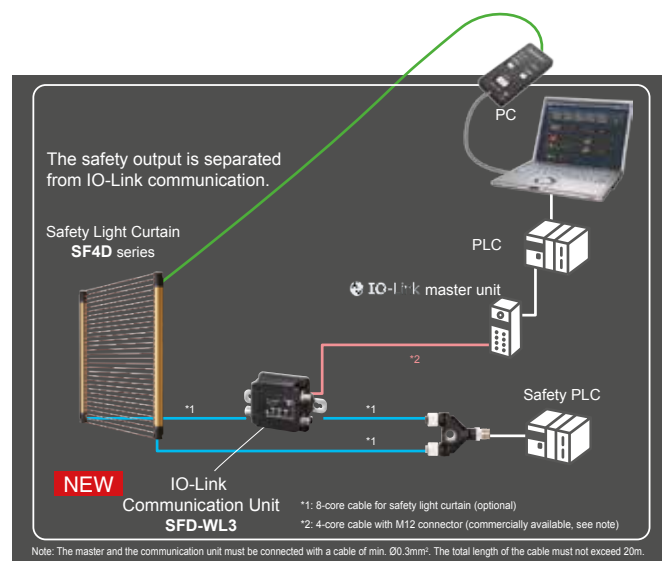



Selection of light curtain

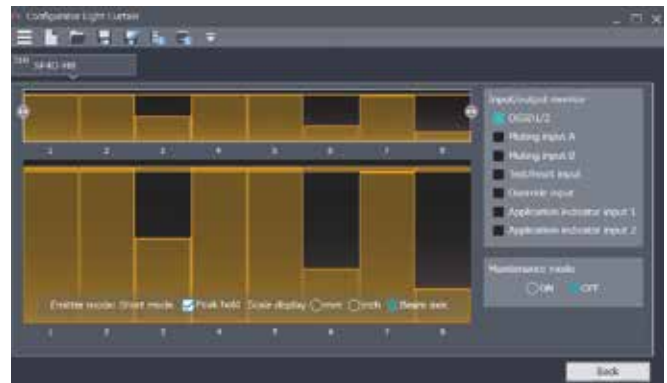

Monitoring of received light intensity and extraneous light during operation

Typical applications

Serial connection of 5 safety light curtains for roboter housing

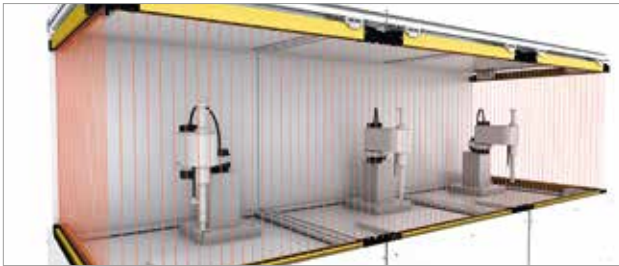

Automobile production with muting

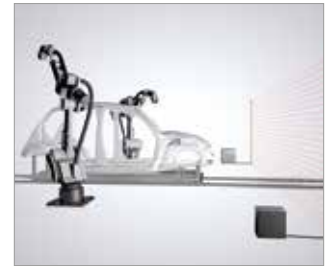
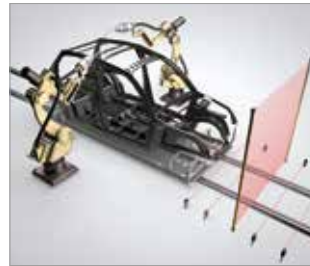

Technical specifications

Typ	Finger protection type	Hand protection type	Arm / Foot protection type
Model no.	SF4-F□ (notes 1,2)	SF4-H□	SF4-A□
Safety category	Typ 4, PLe, SIL3		
Sensing height	150 to 1270mm	150 to 1910mm	
Sensing range	0 to 12m		0 to 15m
Resolution	10mm	20mm	40mm
Object to be sensed	Min. Ø 14mm (opaque)	Min. Ø 25mm (opaque)	Min. Ø 45mm (opaque)
Power supply	24V DC ±10%		
Response time	ON □ OFF: max. 10ms, OFF □ ON: max. 50ms		
Control outputs	OSSD1 and OSSD2 (2 x PNP or 2 x NPN open collector transistor, switchable), max. 350mA		
Emitting element	Infrared LED		
Protection	IP67/ IP65 (IEC)		
Ambient temperature	-10 to +55°C		
Material	Frame: Aluminium / Enclosures: Acrylic, Polycarbonate, Nylon		
Connection method	Connector		
Dimensions (HxWxD)	Hx30x28mm (H= protective height)		

Notes:

- 1.) □ Number of beam channels
- 2.) For a system configuration, please contact your sales office or service hotline: +49 89 45354-2737

IO-Link
SensorsPhotoelectric
SensorsFiber-optic
Sensors

Standard Fibers

Fiber Sensors
Communication
Units

Mark Sensors

Laser Sensors

Safety Sensors

Pressure &
Flow SensorsInductive
Proximity
SensorsMeasurement
SensorsIonizers/
Electrostatic
Sensors

Accessories

SF4D

■ Finger protection type (min. object to be sensed \varnothing 14mm, 10mm beam pitch)

Model no.	Sensing range	No. of beam axes	Protective height	Beam pitch
SF4D-F15	0 to 7m (short mode) 0 to 12m (long mode) (selectable by DIP switch)	15	150mm	10mm
SF4D-F23		23	230mm	
SF4D-F31		31	310mm	
SF4D-F39		39	390mm	
SF4D-F47		47	470mm	
SF4D-F55		55	550mm	
SF4D-F63		63	630mm	
SF4D-F71		71	710mm	
SF4D-F79		79	790mm	
SF4D-F95		95	950mm	
SF4D-F111		111	1110mm	
SF4D-F127		127	1270mm	

■ Hand protection type (min. object to be sensed \varnothing 25mm, 20mm beam pitch)

Model no.	Sensing range	No. of beam axes	Protective height	Beam pitch
SF4D-H8	0 to 9m (short mode) 0 to 15m (long mode) (selectable by DIP switch)	8	150mm	20mm
SF4D-H12		12	230mm	
SF4D-H16		16	310mm	
SF4D-H20		20	390mm	
SF4D-H24		24	470mm	
SF4D-H28		28	550mm	
SF4D-H32		32	630mm	
SF4D-H36		36	710mm	
SF4D-H40		40	790mm	
SF4D-H48		48	950mm	
SF4D-H56		56	1110mm	
SF4D-H64		64	1270mm	
SF4D-H72		72	1430mm	
SF4D-H80		80	1590mm	
SF4D-H88		88	1750mm	
SF4D-H96		96	1910mm	

■ Arm / Foot protection type (min. object to be sensed \varnothing 45mm, 40mm beam pitch)

Model no.	Sensing range	No. of beam axes	Protective height	Beam pitch
SF4D-A4	0 to 9m (short mode) 0 to 15m (long mode) (selectable by DIP switch)	4	150mm	40mm
SF4D-A6		6	230mm	
SF4D-A8		8	310mm	
SF4D-A10		10	390mm	
SF4D-A12		12	470mm	
SF4D-A14		14	550mm	
SF4D-A16		16	630mm	
SF4D-A18		18	710mm	
SF4D-A20		20	790mm	
SF4D-A24		24	950mm	
SF4D-A28		28	1110mm	
SF4D-A32		32	1270mm	
SF4D-A36		36	1430mm	
SF4D-A40		40	1590mm	
SF4D-A44		44	1750mm	
SF4D-A48		48	1910mm	

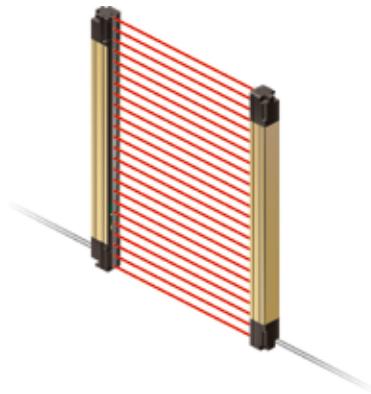

SF4B (V2)

Type 4 · PLe · SIL3

New concepts combining greater safety and higher productivity!

Features

■ Sensor height = protective height

The length of the main unit equals the protective height so that installation is possible in places where space is limited. No blindzone occurs at the joints between light curtains when light curtains are connected in series.

■ Finger/hand and arm/foot protection available

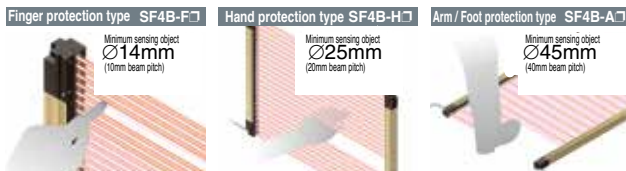

■ Response time of 14ms and constant safety distance

A fast response time of 14ms has been achieved regardless of the number of beam channels, the beam axis pitches and the number of units connected in series. This reduces calculation work required for the safety distances.

■ A muting control function is provided to increase both safety and productivity

The light curtain is equipped with a muting control function that causes the line to stop only when a person passes through the light curtain, not when an object passes through.

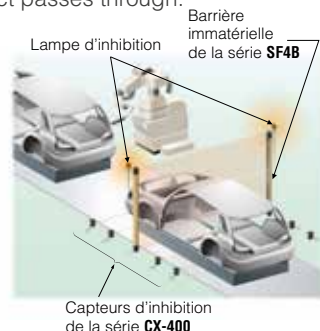

■ Built-in safety relay

The light curtain has a built-in external device monitoring (EDM) function and an interlock function. The safety circuit is constructed so that a separate safety relay unit is not needed, and the control board is also more compact, both of which contribute to lower costs.

■ Improved ambient light immunity

The integrated ELCA function (Extraneous Light Check & Avoid) prevents interference from ambient light or other light curtains and even from welding plants.

■ Digital error indicator

If an error occurs, details of the error appear on the digital display so that maintenance can be carried out more quickly.



■ Universal design that can be used anywhere in the world

The SF4B series combines PNP transistor output and NPN transistor output in a single model. Overseas equipment that uses PNP, replacement with NPN sensors, factories that are positively grounded, and transfer of equipment overseas are all situations where the control circuits for a single model are suitable for use worldwide.

IO-Link
Sensors

Photoelectric
Sensors

Fiber-optic
Sensors

Standard Fibers

Fiber Sensors
Communication
Units

Mark Sensors

Laser Sensors

Safety Sensors

Pressure &
Flow Sensors

Inductive
Proximity
Sensors

Measurement
Sensors

Ionizers/
Electrostatic
Sensors

Accessories

SF4B (V2)

Typical applications

Guarding space around welding robot

A spatter protection hood type perfect for welding devices is also available.

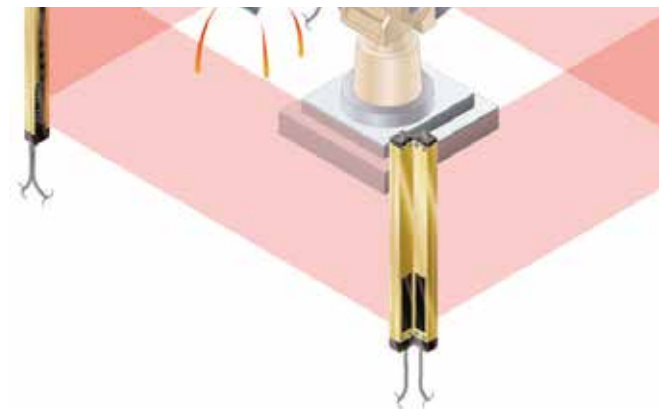

Technical specifications

Type	Finger protection type	Hand protection type	Arm / Foot protection type
Model no.	SF4B-F□(V2) (note)	SF4B-H□(V2)	SF4B-A□(V2)
Safety category	Type 4, PL e, SIL3		
Sensing height	230 to 1270mm	230 to 1910mm	
Sensing range	0 to 7m (depending on type up to 9m)		
Resolution	10mm	20mm	40mm
Object to be sensed	Min. Ø 14mm (opaque)	Min. Ø 25mm (opaque)	Min. Ø 45mm (opaque)
Power supply	24VDC +/-10%		
Response time	ON □ OFF: max. 14ms / OFF □ ON: max. 90ms		
Control outputs	OSSD1 and OSSD2 (2 x PNP or 2 x NPN open collector transistor, switchable), max. 200mA		
Emitting element	Infrared LED		
Protection	IP67 / IP65 (IEC)		
Ambient temperature	-10 to +55°C		
Material	Frame: Aluminium / Enclosures: Acrylic, Polycarbonate, ABS		
Connection method	Connector		
Dimensions (HxWxD)	Hx30x28mm (H= protective height)		

Notes: For a system configuration, please contact your sales office or service hotline: +49 89 45354-2737

IO-Link
SensorsPhotoelectric
SensorsFiber-optic
Sensors

Standard Fibers

Fiber Sensors
Communication
Units

Mark Sensors

Laser Sensors

Safety Sensors

Pressure &
Flow SensorsInductive
Proximity
SensorsMeasurement
SensorsIonizers/
Electrostatic
Sensors

Accessories

SF4B (V2)

Sensing height

	Sensing range	Model no.	Protective height (mm)	Installation height (mm)	No. of beam axes	
Finger protection type	0-7m	SF4B-F23(V2)	230	286	23	
		SF4B-F31(V2)	310	366	31	
		SF4B-F39(V2)	390	446	39	
		SF4B-F47(V2)	470	526	47	
		SF4B-F55(V2)	550	606	55	
		SF4B-F63(V2)	630	686	63	
		SF4B-F71(V2)	710	766	71	
		SF4B-F79(V2)	790	846	79	
		SF4B-F95(V2)	950	1006	95	
		SF4B-F111(V2)	1110	1166	111	
		SF4B-F127(V2)	1270	1326	127	
Hand protection type	0-9m	SF4B-H12(V2)	230	286	12	
		SF4B-H16(V2)	310	366	16	
		SF4B-H20(V2)	390	446	20	
		SF4B-H24(V2)	470	526	24	
		SF4B-H28(V2)	550	606	28	
		SF4B-H32(V2)	630	686	32	
		SF4B-H36(V2)	710	766	36	
		SF4B-H40(V2)	790	846	40	
		SF4B-H48(V2)	950	1006	48	
		SF4B-H56(V2)	1110	1166	56	
		SF4B-H64(V2)	1270	1326	64	
	0-7m	SF4B-H72(V2)	1430	1486	72	
		SF4B-H80(V2)	1590	1646	80	
		SF4B-H88(V2)	1750	1806	88	
		SF4B-H96(V2)	1910	1966	96	
	Arm / Foot protection type	0-9m	SF4B-A6(V2)	230	286	6
			SF4B-A8(V2)	310	366	8
SF4B-A10(V2)			390	446	10	
SF4B-A12(V2)			470	526	12	
SF4B-A14(V2)			550	606	14	
SF4B-A16(V2)			630	686	16	
SF4B-A18(V2)			710	766	18	
SF4B-A20(V2)			790	846	20	
SF4B-A24(V2)			950	1006	24	
SF4B-A28(V2)			1110	1166	28	
SF4B-A32(V2)			1270	1326	32	
0-7m		SF4B-A36(V2)	1430	1486	36	
		SF4B-A40(V2)	1590	1646	40	
		SF4B-A44(V2)	1750	1806	44	
		SF4B-A48(V2)	1910	1966	48	

IO-Link
SensorsPhotoelectric
SensorsFiber-optic
Sensors

Standard Fibers

Fiber Sensors
Communication
Units

Mark Sensors

Laser Sensors

Safety Sensors

Pressure &
Flow SensorsInductive
Proximity
SensorsMeasurement
SensorsIonizers/
Electrostatic
Sensors

Accessories

SF4B (V2)

IO-Link
SensorsPhotoelectric
SensorsFiber-optic
Sensors

Standard Fibers

Fiber Sensors
Communication
Units

Mark Sensors

Laser Sensors

Safety Sensors

Pressure &
Flow SensorsInductive
Proximity
SensorsMeasurement
SensorsIonizers/
Electrostatic
Sensors

Accessories

SF4B-C



SF4B-C

Type 4 · PLe · SIL3

Mounts flush on aluminum frames

Features

■ Compact size

The **SF4B-C** series has been designed to mount flush with the aluminum frame. This means the machine opening will not be made any narrower. It can even be installed with zero blind zone.

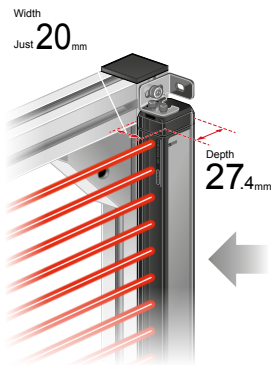

■ Easy mounting on aluminum frame



Buried mounting (side)

The light curtain mounts flush, even in installations with buried mounting.

- › There is no risk of workpieces bumping into the light curtain.

Rear mounting

- › The light curtain fits onto a 20 × 20mm aluminum frame perfectly.



■ The SFB-HC handy controller (optional)

offers easy access to settings for a range of functionality.

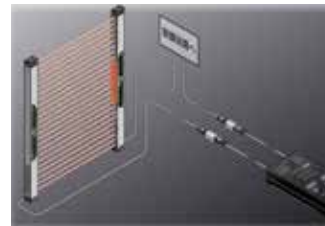

■ With the pigtailed type, the large indicator is easy to see also from the side

The SF4B-C series incorporates a large multi-purpose indicator (orange) positioned at workers' eye level. The indicator signals the presence of the light curtain, helping to prevent stoppages due to inadvertent interruption of its beams. The indicator can be used in a variety of applications, including as a muting indicator or operation indicator. The large multi-purpose indicator shines brightly through the plastic body to ensure exceptional visibility from the side.

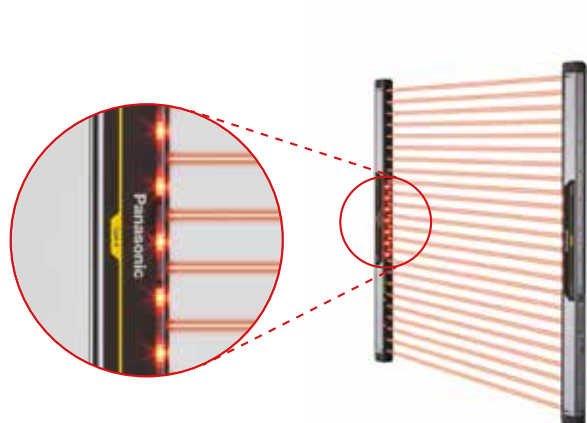

Technical specifications

Type	Pigtailed type (note 1, 2)		Cable type	
	Hand protection type	Arm protection type	Hand protection type	Arm protection type
Model no.	SF4B-H12CA-J05	SF4B-A12CA-J05	SF4B-H12C	SF4B-A12C
Safety category	Type 4, PLe, SIL3			
Protective height	263.4 to 1943.4mm			
Sensing range	0 to 7m			
Beam pitch	20mm	40mm	20mm	40mm
Object to be sensed	Min. Ø 25mm (opaque)	Min. Ø 45mm (opaque)	Min. Ø 25mm (opaque)	Min. Ø 45mm (opaque)
Supply voltage	24V DC ±10%			
Response time	ON → OFF: max. 14ms / OFF → ON: max. 90ms			
Control outputs	OSSD1 and OSSD2 (2 x PNP or 2 x NPN open collector transistor, switchable), max. 200mA			
Emitting element	Infrared LED, 850nm			
Protection	IP65 (IEC)			
Ambient temperature	-10 to +55°C			
Material	Polycarbonate			
Connection method	12-wire PVC cable with connector, 0.5m		8-wire PVC cable, 5m	
Dimensions (HxWxD)	Hx20x27.4mm (H= depending on protective height)			

Notes:

- 1.) For a system configuration, please contact your sales office or service hotline: +49 (0) 89-45354-2737
- 2.) Integrated muting function

Protective height

	Model no.		Protective height (mm)	Installation height (mm) (note)	No. of beam axes
	Pigtailed type (note)	Cable type			
Hand protection type	SF4B-H12CA-J05	SF4B-H12C	263.4	294.4	12
	SF4B-H16CA-J05	SF4B-H16C	343.4	374.4	16
	SF4B-H20CA-J05	SF4B-H20C	423.4	454.4	20
	SF4B-H24CA-J05	SF4B-H24C	503.4	534.4	24
	SF4B-H28CA-J05	SF4B-H28C	583.4	614.4	28
	SF4B-H32CA-J05	SF4B-H32C	663.4	694.4	32
	SF4B-H36CA-J05	SF4B-H36C	743.4	774.4	36
	SF4B-H40CA-J05	SF4B-H40C	823.4	854.4	40
	SF4B-H48CA-J05	SF4B-H48C	983.4	1014.4	48
	SF4B-H56CA-J05	SF4B-H56C	1143.4	1174.4	56
	SF4B-H64CA-J05	SF4B-H64C	1303.4	1334.4	64
	SF4B-H72CA-J05	SF4B-H72C	1463.4	1494.4	72
	SF4B-H80CA-J05	SF4B-H80C	1623.4	1654.4	80
	SF4B-H88CA-J05	SF4B-H88C	1783.4	1814.4	88
	SF4B-H96CA-J05	SF4B-H96C	1943.4	1974.4	96
Arm protection type	SF4B-A8CA-J05	SF4B-A8C	343.4	374.4	8
	SF4B-A12CA-J05	SF4B-A12C	503.4	534.4	12
	SF4B-A16CA-J05	SF4B-A16C	663.4	694.4	16
	SF4B-A20CA-J05	SF4B-A20C	823.4	854.4	20
	SF4B-A24CA-J05	SF4B-A24C	983.4	1014.4	24
	SF4B-A28CA-J05	SF4B-A28C	1143.4	1174.4	28
	SF4B-A32CA-J05	SF4B-A32C	1303.4	1334.4	32
	SF4B-A36CA-J05	SF4B-A36C	1463.4	1494.4	36
	SF4B-A40CA-J05	SF4B-A40C	1623.4	1654.4	40
	SF4B-A44CA-J05	SF4B-A44C	1783.4	1814.4	44
SF4B-A48CA-J05	SF4B-A48C	1943.4	1974.4	48	

Note: The installation height depends on the mounting bracket. Specifications with standard mounting bracket **MS-SF4BC-1**

IO-Link
SensorsPhotoelectric
SensorsFiber-optic
Sensors

Standard Fibers

Fiber Sensors
Communication
Units

Mark Sensors

Laser Sensors

Safety Sensors

Pressure &
Flow SensorsInductive
Proximity
SensorsMeasurement
SensorsIonizers/
Electrostatic
Sensors

Accessories

SF4B-C

IO-Link
SensorsPhotoelectric
SensorsFiber-optic
Sensors

Standard Fibers

Fiber Sensors
Communication
Units

Mark Sensors

Laser Sensors

Safety Sensors

Pressure &
Flow SensorsInductive
Proximity
SensorsMeasurement
SensorsIonizers/
Electrostatic
Sensors

Accessories

SF4C



SF4C

Type 4 · PLe · SIL3

Ultra-slim light curtain safeguards
machines without sacrificing
productivity

Features

Large, built-in, multi-purpose LED indicators

Large LED bars on each side of the light curtain provide a wide visibility indicator that can be customized for various applications by means of independent external inputs. The indicator can be used as an operation indicator (muting) or job indicator, etc.

Finger/hand protection

The **SF4C** series covers a sensing height of 160mm to 640mm. This is true for the finger and hand protection types (resolution up to 10 or 20mm).

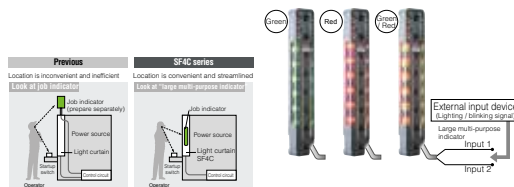

Can be used in a variety of applications for simplified equipment (large multi-purpose indicator)

Wire-saving when connecting to safety devices. Contact outputs such as emergency stop switches or safety door switches can be connected to the light curtain. Also, by using the handy-controller **SFC-HC**, up to three sets of light curtains can be cascade connected for a consolidated safety output.

IP67 (IEC)

An IP67 (IEC) rating is achieved with an ultra-slim size for protection from environmental factors.

Mutual interference is reduced without need for interference prevention lines

The light curtain is equipped with the ELCA (Extraneous Light Check & Avoid) function, which has been proven to be strong against mutual interference. Because it automatically shifts the scanning time of the light curtain in order to avoid interference, it is not necessary to wire interference prevention lines between machinery.

A fast response time of 7ms* for all models

A fast response time of 7ms* for all models regardless of the number of beam channels. This reduces the safety distance as well as the calculation work required for the safety distance among models with different beam channels.

* When connecting safety sensors (light curtains, etc.) to the safety input, the response time will be the total time of connected units.

Safety, productivity, and cost reduction [muting control function]

The muting sensors and muting lamps can be connected directly to the light curtain. Furthermore, the large multi-purpose indicators can be used as muting lamps, which contribute to less wiring troubles, improvement of safety, productivity, and cost reduction.

Typical applications

Use of internal muting lamp

There is no need to buy and install a separate muting lamp.

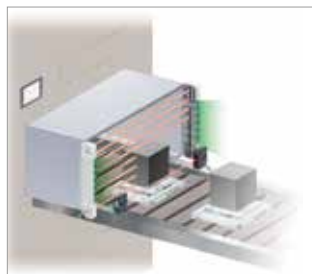

Selective muting area

Separate muting control function for each beam channel.



Industry first!

Wire-saving when connecting to safety devices (safety input function).



Technical specifications

Type	Finger protection type	Hand protection type
Model no.	SF4C-F□ (note)	SF4C-H□
Safety category	Type 4, PLe, SIL3	
Sensing height	Depending on types (160 to 640mm)	
Sensing range	0 to 3m	
Resolution	10mm	20mm
Object to be sensed	Min. Ø 14mm (opaque)	Min. Ø 25mm (opaque)
Power supply	24VDC +10/-15%	
Control outputs	OSSD1 and OSSD2 (2x PNP or 2x NPN transistor outputs with open collector, switchable, max. 200mA)	
Response time	ON □ OFF max. 9ms / OFF □ ON max. 90ms	ON □ OFF max. 7ms / OFF □ ON max. 90ms
Rated current consumption	Max. 270mA (depending on type)	
Protection	IP67 / IP65 (IEC)	
Ambient temperature	-10 to +55°C	
Material	Polycarbonate	
Connection method	Cable, 5m or 0.5m with connector	
Dimensions (HxWxD)	Hx13.2x30mm (H= protective height)	

Note: For a system configuration, please contact your sales office or service hotline: +49 89 45354-2737

Sensing height

Finger protection type	Model no.		Protective height (mm)	Installation height (mm)	No. of beam axes
	Cable type	Cable with connector			
	SF4C-F15	SF4C-F15-J05	160	160	15
	SF4C-F23	SF4C-F23-J05	240	240	23
	SF4C-F31	SF4C-F31-J05	320	320	31
	SF4C-F39	SF4C-F39-J05	400	400	39
	SF4C-F47	SF4C-F47-J05	480	480	47
	SF4C-F55	SF4C-F55-J05	560	560	55
	SF4C-F63	SF4C-F63-J05	640	640	63

Hand protection type	Model no.		Protective height (mm)	Installation height (mm)	No. of beam axes
	Cable type	Cable with connector			
	SF4C-H8	SF4C-H8-J05	160	160	8
	SF4C-H12	SF4C-H12-J05	240	240	12
	SF4C-H16	SF4C-H16-J05	320	320	16
	SF4C-H20	SF4C-H20-J05	400	400	20
	SF4C-H24	SF4C-H24-J05	480	480	24
	SF4C-H28	SF4C-H28-J05	560	560	28
	SF4C-H32	SF4C-H32-J05	640	640	32

IO-Link
SensorsPhotoelectric
SensorsFiber-optic
Sensors

Standard Fibers

Fiber Sensors
Communication
Units

Mark Sensors

Laser Sensors

Safety Sensors

Pressure &
Flow SensorsInductive
Proximity
SensorsMeasurement
SensorsIonizers/
Electrostatic
Sensors

Accessories

SF4C

IO-Link
SensorsPhotoelectric
SensorsFiber-optic
Sensors

Standard Fibers

Fiber Sensors
Communication
Units

Mark Sensors

Laser Sensors

Safety Sensors

Pressure &
Flow SensorsInductive
Proximity
SensorsMeasurement
SensorsIonizers/
Electrostatic
Sensors

Accessories

SF2B/SF2C

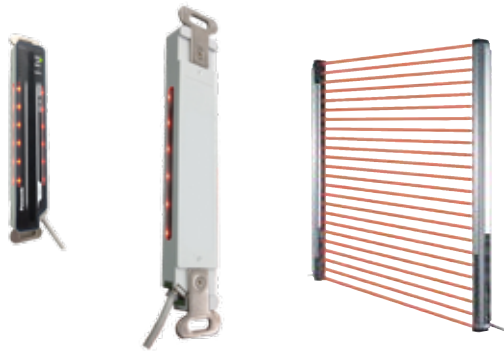

SF2B / SF2C

Safety category 2

Excellent basic functions at a reasonable price

Besonderheiten

■ We also offer safety light curtains with safety category 2

- › Protective height: 160 to 1912mm
- › Sensing range: 0 to 13m
- › Response time: max. 15ms (ON → OFF)
- › Arm and hand protection type
- › Integrated status LEDs and display
- › Series connection without blind zone
- › Features: Interference suppression, series connection, emission halt function

■ Arm / foot protection type SF2B-A□

Min. sensing object \varnothing 47mm
(beam pitch 40mm)



■ Hand protection type SF2B-H□

Min. sensing object \varnothing 27mm
(beam pitch 20mm)



Typical applications

Protection against malfunction caused by extraneous light



Protection against mutual interference thanks to interference prevention

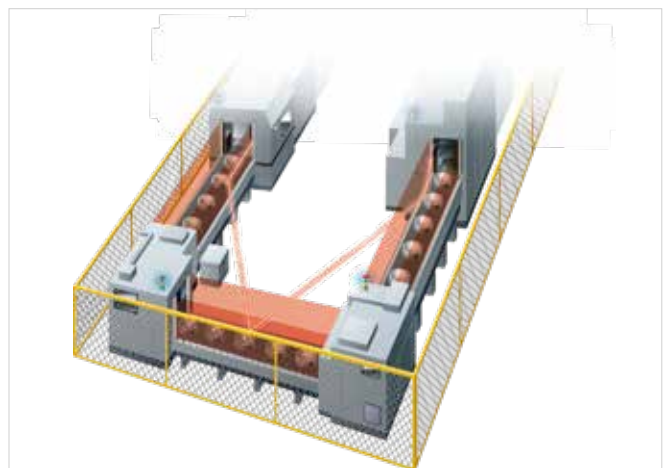



Customization of automation products

Panasonic has been perfecting the art of customization for over 10 years. Our experts work with customers, engineers, and purchasing and logistic departments to configure the most suitable customized solution in terms of product modification, packaging, labeling, pre-assembly and other features. High quality is assured thanks to multiple product tests that are conscientiously documented. Customized automation products can reduce your production costs, avoid production errors, and improve the quality of your final product.

- › Customized cabling and interfacing
- › Application specific setting of sensors
- › Re-packaging for immediate customer use
- › Sensors bundled with PLC/HMI as a solution
- › Customer specific mounting of connectors on Panasonic Industry sensors



<https://industry.panasonic.eu>

IO-Link
SensorsPhotoelectric
SensorsFiber-optic
Sensors

Standard Fibers

Fiber Sensors
Communication
Units

Mark Sensors

Laser Sensors

Safety Sensors

Pressure &
Flow SensorsInductive
Proximity
SensorsMeasurement
SensorsIonizers/
Electrostatic
Sensors

Accessories

SG-P



SG-P

Non – contact safety door switch

Features

■ High visibility

Door switches installed on the inside of doors are difficult to see from the outside, so it is hard to check whether the doors are open or closed. The **SG-P** series units are highly visible from the outside, thus allowing reliable confirmation. The SG-P series eliminates the need to install switches on the outside of equipment, and it contributes to the simplification of equipment



For frame-less doors

Compact type: SG-P1010-□ / SG-P2010-□

■ No prior pairing

Each switch body and actuator can be easily paired by bringing them close to each other and supplying power during the initial setup. When the units are cascade-connected, turning on the power completes the pairing procedures in a batch, thus reducing the man-hours required for the setup.

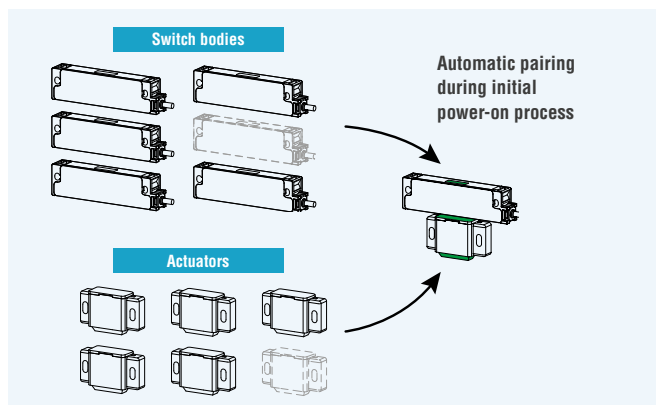

■ High-code actuator

Intentional deactivation of a safety switch can lead to a serious industrial disaster. The SG-P series high-code models detect only the paired actuators. They support the ISO 14119 coding level (High Level Coded Actuator) and prevent intentional deactivation of safety switches.

■ 30 units in series

Previously, when cascade connection is used, extra man-hours are required for connecting wires to the switches for linked operation. When the SG-P series is installed, the standard model serves as a master unit and outputs safety signals (OSSD1 / 2) in a batch. No extra wiring work is necessary for cascade connection of the sub units that serve as slave units. A maximum of 30 units can be connected, thus contributing to the reduction of equipment wiring work.

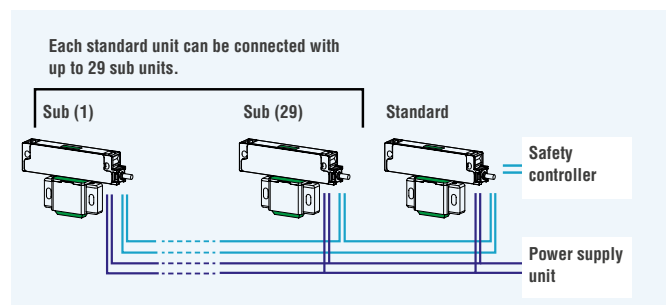

Large and bright indicators notify the open / Closed conditions of machine room doors

When any of the safety switches connected in series enters a non-detecting state, the flashing function activates the

indicators of all other safety switches to flash in green to notify the operator.

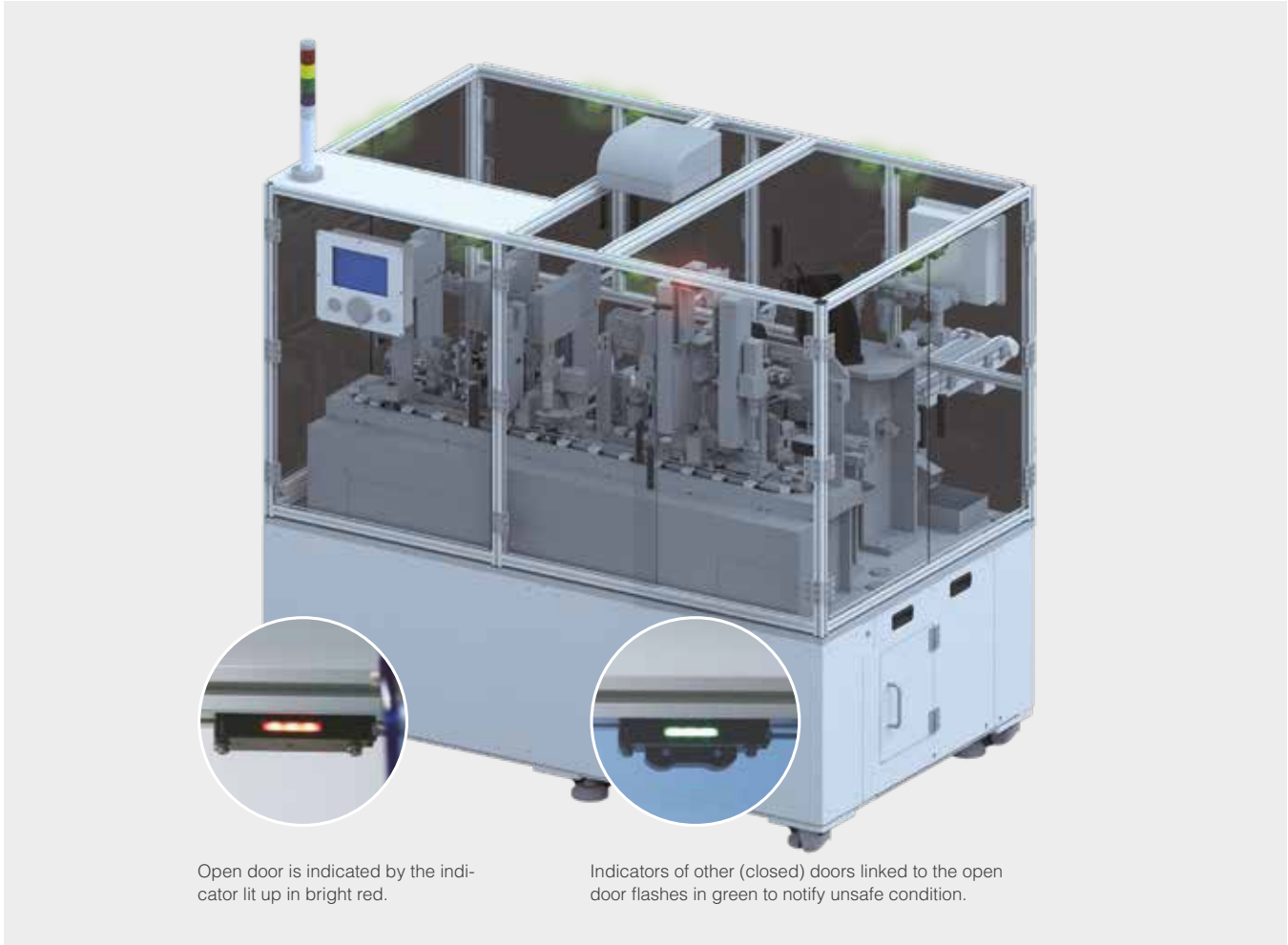

Technical specifications

Type	Standard, PNP output	Standard, NPN output	Sub
Model no.	SG-P□-M-P	SG-P□-M-N	SG-P□-S
Applicable standards	ISO 13849-1 (Category 4, PL _e), IEC 61508-1 to 7 (SIL3), IEC 62061 (SIL3), IEC 60947-5-3, ISO 14119, EN 60947-5-3, EN 300 330, EN 301 489-1		
Operating distance	Sao (OFF→ON): 5 mm, Sar (ON→OFF): 15 mm		
Power supply voltage	24V DC		
Output	2 x PNP open-collector transistor, max. 100mA	2 x NPN open-collector transistor, max. 100mA	-
Response time	For single unit: ON→OFF max. 100ms, OFF→ON max. 100ms For multiple units: Time for single unit + 5ms x (number of connected units - 1)		
Material	Housing: PBT, LC display: Acrylic, Pressure port: SUS 303, thread: brass, buttons: silicon rubber		
Connection method	6-core cabtyre cable, 5m		4-core cabtyre cable, 3m
Protection	IP 67 (IEC)		
Pollution degree	3 (Innen 2)		
Dimensions (HxWxD)	Compact type: 93x25x15mm; Actuator: 56x13x15mm Visible type: 93x25x15mm; Actuator: 52x32x15mm		

IO-Link
Sensors

Photoelectric
Sensors

Fiber-optic
Sensors

Standard Fibers

Fiber Sensors
Communication
Units

Mark Sensors

Laser Sensors

Safety Sensors

Pressure &
Flow Sensors

Inductive
Proximity
Sensors

Measurement
Sensors

Ionizers/
Electrostatic
Sensors

Accessories

SG-P

IO-Link
SensorsPhotoelectric
SensorsFiber-optic
Sensors

Standard Fibers

Fiber Sensors
Communication
Units

Mark Sensors

Laser Sensors

Safety Sensors

Pressure &
Flow SensorsInductive
Proximity
SensorsMeasurement
SensorsIonizers/
Electrostatic
Sensors

Accessories

ST4



ST4

Type 4 · PLe · SIL3

Cascadable thru-beam sensors

Features

■ Series connection of six sets of sensor heads to one controller

The concept of connecting six sets of sensor heads to one controller in series offers you maximum flexibility to solve your safety application.

■ Beam axis alignment and operation confirmation

The beam interruption indicator is incorporated in both the emitter and receiver. This indicator can be used not only to confirm operation but also to align the beam axis.

■ Compact sensor head saves space

The size of this type 4 long sensing range type is similar to general purpose photoelectric sensors.

■ IP67 (IEC)

The sensor heads can be used safely even in rough production environments.

■ Interference prevention

The emission amount adjuster can be used to prevent interference to the surrounding sensors.

■ Supports both PNP and NPN polarities

A single unit supports both PNP and NPN polarities, easing stock management.

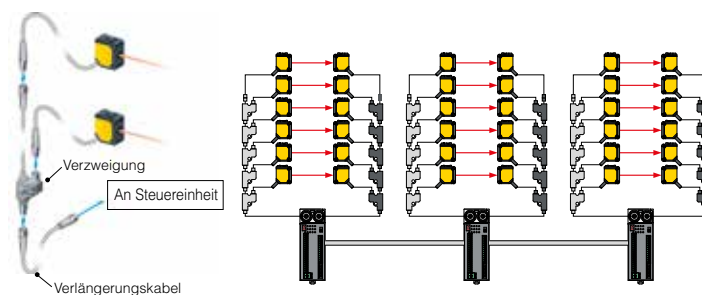

Emission amount adjustment function

Typical applications

Protection for long sensing ranges

Guard areas up to 15m in length, for example where protective fences are difficult to install.

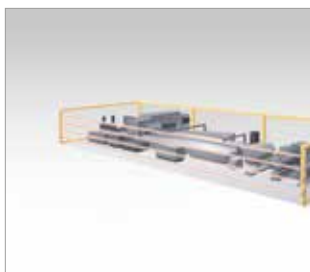

Protection for small openings

For small openings where light curtains do not fit, ST4 sensor heads ensure safety.



Protection against non-authorized entry

Sensor heads can be mounted flexibly and muting control implemented easily.



Technical specifications

■ Sensor heads

Type	Cable length 0.2m		Cable length 1.0m	
	–	With sensitivity adjuster	–	With sensitivity adjuster
Model no.	ST4-A1-J02	ST4-A1-J02V	ST4-A1-J1	ST4-A1-J1V
Safety category	Type 4, PL _e , SIL3			
Cascading	Up to 6 pieces to one controller			
Power supply	Supplied from controller (ST4-C11 or ST4-C12EX)			
Sensing range	0 to 15m			
Object to be sensed	Min. ø 9mm (opaque)			
Emitting element	Infrared LED			
Protection	IP67 (IEC)			
Ambient temperature	–10 to +55°C			
Material	Enclosure: PBT/Cover: acrylic			
Connection method	Cable with connector enclosed, 0.2m		Cable with connector enclosed, 1.0m	
Dimensions (HxWxD)	31x14x28mm			

■ Control device

Type	Standard	High-functional
Model no.	ST4-C11	ST4-C12EX
Safety category	Type 4, PL _e , SIL3	
Power supply	24VDC +10% / –15%	
Control outputs	OSSD1 and OSSD2 (2x PNP or 2x NPN transistor outputs with open collector, switchable, max. 200mA)	
Response time	ON □ OFF: max. 25ms, OFF □ ON: max. 140ms	
Current consumption	Max. 100mA (excluding sensor heads)	Max. 120mA (excluding sensor heads)
Protection	Enclosure: IP40 (IEC), Terminal: IP20 (IEC)	
Ambient temperature	–10 to +55°C	
Material	Enclosure: ABS	
Connection method	Connector (sensors), terminal block	
Dimensions (HxWxD)	130x46x80mm	

Note: For a system configuration, please contact your sales office or service hotline: +49 89 45354-2737

IO-Link
SensorsPhotoelectric
SensorsFiber-optic
Sensors

Standard Fibers

Fiber Sensors
Communication
Units

Mark Sensors

Laser Sensors

Safety Sensors

Pressure &
Flow SensorsInductive
Proximity
SensorsMeasurement
SensorsIonizers/
Electrostatic
Sensors

Accessories

ST4



SF-C21

Control unit for multiple safety solutions

Features

Space-saving and easy to wire

- › One **SF-C21** can do the work of four safety relay units.
Input: 10 points / Output: 8 points
- › Compact size
(height 97 mm × width 45 mm)

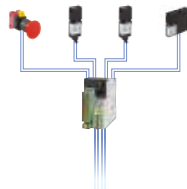

Application-based customization

- › Easy to create reliable safety circuit
- › Configurator SF-C software to build own safety circuits



Absolutely no programming skills required

- › Eight preset logics, safety-certified and compatible to control category 4 PLe
- › The OFF delay time can be easily set by turning the rotary switch
- › Password protection prevents inadvertent changes to the logic

Easy to monitor status with a PLC

- › Four auxiliary outputs are provided
- › RS-485 communications (MODBUS RTU)



Technical specifications

Model. no.	SF-C21	
Safety standards	IEC 61508-1 to 7, EN 61508-1 to 7(SIL3), ISO 13849-1 (up to Category 4, PLe), IEC 61131-2, IEC 61010-2-201, IEC 62061(SILCL3), UL 61010-1, UL 61010-2-201	
EMC standards	IEC 61000-6-2, IEC 61326-3-1, EN 55011	
Related standards	IEC 60947-1, IEC 60947-5-1, IEC 60947-5-2, IEC 60947-5-5, IEC 60947-5-8, IEC 61496-1, IEC TS 62046, ISO 13851	
Safety input	2 × 4 inputs (ON □ OFF max. 0.7ms; OFF □ ON max. 10ms)	
Safety control output	PNP open-collector transistor with 2 outputs × 2 (ON □ OFF max. 10ms; OFF □ ON max. 100ms)	
Auxiliary output	PNP open-collector transistor with 1 output × 4 (Any of the auxiliary outputs can be customized using the software tool)	
Logic selection function	No. 0: Customization control No. 2: Parallel muting control No. 4: Partial stop control 1 No. 6: Two-hand control No. 8: Operation mode selection control	No. 1: Overall stop control No. 3: Sequential muting control No. 5: Partial stop control 2 No. 7: OR control
Communication	RS-485: Detachable spring-cage terminal block, USB: Mini-B male	

Note: We also offer the safety control unit **SF-C10 series** (see next page), which is ideal for controlling Panasonic's safety light curtain, because its connectors make wiring easier



SF-C10

Less setup time for safety light curtains

Features

■ Supports both PNP and NPN polarities

A single unit can be used for PNP / NPN input switching, reducing the number of parts that need to be registered.

■ Removable terminal blocks reduce maintenance time

Removable terminal blocks are used. This reduces the work required for reconnecting wiring during maintenance

Removable!
Uses a spring method

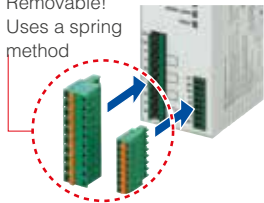

■ Metal enclosure with an IP65 (IEC) protective structure

The strong metal enclosure has a built-in safety relay. It has an IP65 protective structure so that it can be set up individually without needing to be inserted into a control panel.



Connector in metal housing

■ Slim design

22.5mm thickness for insertion even into narrow spaces inside panels.



■ Three safety circuit systems packaged into a single unit!

The unit has three different built-in safety circuits: Output circuit of the safety light curtain, muting safety circuit, and emergency stop safety circuit.



SF-C13

SF-C14EX

SF-C11

SF-C12

IO-Link
Sensors

Photoelectric
Sensors

Fiber-optic
Sensors

Standard Fibers

Fiber Sensors
Communication
Units

Mark Sensors

Laser Sensors

Safety Sensors

Pressure &
Flow Sensors

Inductive
Proximity
Sensors

Measurement
Sensors

Ionizers/
Electrostatic
Sensors

Accessories

SF-C10



DP-0

Compact and easy-to-use
pressure sensor

Features

■ RUN and detailed setting mode

Pressure sensors of the DP-0 series operate in two different modes. RUN mode is used for quick access to settings like threshold values, zero point, and key lock functions. The detailed setting mode offers additional settings such as selecting the pressure unit or the response time. The two modes together help to achieve an optimum sensor performance.

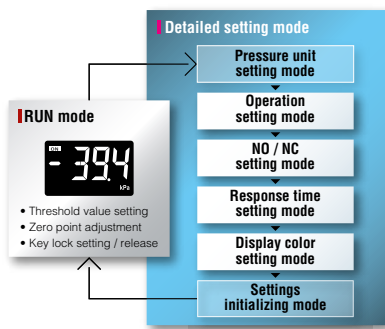

■ Functional design

The unit body is completely black to make the LCD display easier to see. The keys offer a firm and crisp clicking feel, thus making operating the sensor smooth and reliable.



■ Compact & lightweight design

The unit body measures only 24.9mm in depth, which allows installation in a narrow space. The body weighs only 25g. The low weight is very advantageous if the sensor has to be mounted on moving parts, e.g. robot arms.



■ Low and high pressure type available

The low pressure type can be used with positive or negative pressure. It is ideal for suction applications where it indicates malfunctions due to pressure changes. The high pressure type is suitable for positive pressure of up to 1MPa. It is ideal for applications where a reference pressure needs to be checked.

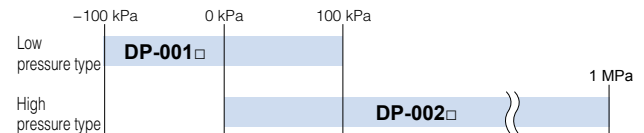

Typical applications

Monitoring suction pressure on electronic components



Checking reference pressure



Technical specifications

Type		Low pressure type	High pressure type
Model no.	PNP	DP-001-P	DP-002-P
	NPN	DP-001	DP-002
Type of pressure		Gauge pressure	
Rated pressure range (note 2)		-1 to +1bar (-100 to +100kPa)	0 to +10bar (0 to 1MPa)
Pressure withstandability		5bar (500kPa)	15bar (1.5MPa)
Applicable fluid		Non-corrosive gas	
Supply voltage		12 to 24V DC \pm 10%	
Output		3x NPN or PNP transistor, max. 50mA	
Response time		2.5, 25, 250ms (switchable)	
Pressure port		M5 female thread	
Degree of protection		IP40	
Ambient temperature		-10 to +50°C	
Material		Resin body type	
Connection method		Connector (note 1)	
Dimensions (HxWxD)		30x30x25mm	
Accessories		CN-14A-C2 connector-attached cable 2m, 1 pc	

Notes:

- 1.) The 2m cable **CN-14A-C2** is included
- 2.) Where measurement conditions have not been specified precisely, the conditions used were an ambient temperature of +20°C. Reference pressure 1atm

IO-Link
SensorsPhotoelectric
SensorsFiber-optic
Sensors

Standard Fibers

Fiber Sensors
Communication
Units

Mark Sensors

Laser Sensors

Safety Sensors

Pressure &
Flow SensorsInductive
Proximity
SensorsMeasurement
SensorsIonizers/
Electrostatic
Sensors

Accessories

DP-100



DP-100

Pressure sensors with dual display

Features

- **The current and threshold values can be checked at the same time!**



- **Dual display allows direct setting of threshold value**

Equipped with a 30mm square compact dual display. Because the current and threshold value can be checked at the same time, the threshold value can be set and checked smoothly without having to switch screen modes.

- **3-color display (red, green, orange)**

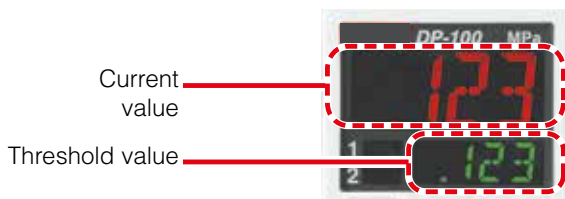

The main display color changes depending on the output status (ON/OFF operation) and while settings are being made. The sensor status can therefore be understood easily, and operating errors can be reduced.

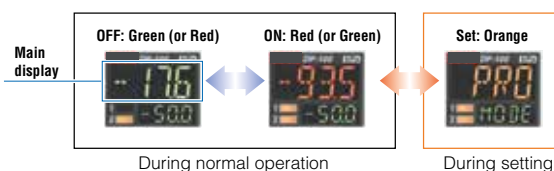

- **Easy-to-read digital display!**

A clear 12-segment make numbers and letters easy to read.

- **High performance**



The low pressure type displays measurements in 0.1kPa at a resolution of 1/2000 and has a response time of 2.5ms (variable up to 5000ms). Moreover it boasts $\pm 0.5\%$ F.S. temperature characteristics and $\pm 0.1\%$ F.S. repeatability.

For low pressure

- **Copy function saves time and reduces human error**

Sensors can be connected to a master sensor one by one and settings copied to them. When making the same settings for multiple sensors, this prevents setting errors from occurring and reduces the number of changes required to instruction manuals when equipment designs are changed.



- **Equipped with auto-reference and remote zero-adjustment functions A precise pressure management is possible**

If the reference pressure of the device changes, the auto-reference function partially shifts the comparative output judgment level by the amount that the reference pressure shifts and resets the display value to zero. These functions are ideal for places where the reference pressure fluctuates wildly, or where fine settings are desired.

Typical applications

Confirming suction of electronic component



Confirming reference pressure



Leak test for PET bottles



Technical specifications

Cable types

Type	Standard		High-function controller		
Model no.	Asian	DP-101 (note 1)	DP-102	DP-101A	DP-102A
	European	DP-101-E-P	DP-102-E-P	DP-101A-E-P	DP-102A-E-P
	M5 female thread Short porttype	DP-101-M-P	DP-102-M-P	DP-101A-M-P	DP-102A-M-P
Rated pressure range (note 3)	-1bar to +1bar (-100.0 to +100.0kPa)		-1bar to +10bar (-0.1 to +1.0MPa)	-1bar to +1bar (-100.0 to +100.0kPa)	-1bar to +10bar (-0.1 to +1.0MPa)
Applicable fluid	Non-corrosive gas				
Power supply	12 to 24V DC \pm 10%				
Output	PNP / NPN open-collector transistor, max. 100mA				
Analog output	—		4 to 20mA/0 to 10V		
Response time	2.5ms, 5ms, 10ms, 25ms, 50ms, 100ms, 250ms, 500ms, 1000ms, 5000ms, selectable by key operation				
Display	3-color LCD display, 12 segments, 4 digits				
Pressure port	Asian: M5 female thread + R (PT) 1/8 male thread European: M5 female thread + G 1/8 male thread				
Connection method	Connector (note 2)				
Dimensions (HxWxD)	30x30x42.5mm				
Accessories	CN-14A-C2 Connector attached cable 2m, 1 pc.				

Notes:

- Suffix-E = Air supply M5 female thread and G 1/8 male thread
Suffix-M = M5 short port type
Suffix-P = PNP output
- CN-14A-C2 cable 2m is included in delivery
- Where measurement conditions have not been specified precisely, the conditions used were an ambient temperature of +20°C. Reference pressure=1atm

M8 connector types

Type	Standard		Multifunction	
Model no.	DP-111-E-P-J	DP-112-E-P-J	DP-111A-E-P-J	DP-112A-E-P-J
Rated pressure range (note 1)	-1bar to +1bar (-100.0 to +100.0kPa)	-1bar to +10bar (-0.1 to +1.0MPa)	-1bar to +1bar (-100.0 to +100.0kPa)	-1bar to +10bar (-0.1 to +1.0MPa)
Applicable fluid	Non-corrosive gas			
Power supply	12 to 24V DC \pm 10%			
Output	PNP open-collector transistor, max. 100mA			
Response time	2.5ms, 5ms, 10ms, 25ms, 50ms, 100ms, 250ms, 500ms, 1000ms, 5000ms, selectable by key operation			
Analog volt. output / external input	—		Incorporated	
Ambient temperature	-10 to +50°C			
Pressure port	G1/8 male thread + M5 female thread			
Material	Enclosure: PBT (glass fiber reinforced); LCD display: Acrylic; Pressure port: Stainless steel (SUS303); Thread part: Brass (nickel plated); Switch part: Silicone rubber, M8 connector part: Nickel-plated brass/brass gold plated contacts			
Connection method	M8 connector (note 2)			
Dimensions (HxWxD)	30x30x47.5mm			
Accessories	Unit selection plate: 1 set			

Notes:

- Where measurement conditions have not been specified precisely, the conditions used were an ambient temperature of +20°C. Reference pressure=1atm
- Cable not included in delivery, please select under accessories (page 129)

IO-Link
SensorsPhotoelectric
SensorsFiber-optic
Sensors

Standard Fibers

Fiber Sensors
Communication
Units

Mark Sensors

Laser Sensors

Safety Sensors

Pressure &
Flow SensorsInductive
Proximity
SensorsMeasurement
SensorsIonizers/
Electrostatic
Sensors

Accessories

DP-100

IO-Link
SensorsPhotoelectric
SensorsFiber-optic
Sensors

Standard Fibers

Fiber Sensors
Communication
Units

Mark Sensors

Laser Sensors

Safety Sensors

Pressure &
Flow SensorsInductive
Proximity
SensorsMeasurement
SensorsIonizers/
Electrostatic
Sensors

Accessories

DPC-100/
DPH-100

DPC-100/ DPH-100

Single-axis type digital pressure sensor with optional dual 3-color display

Features

■ Automatic sensor head recognition

The controller automatically recognizes sensor heads when they are connected, even if their rated pressure ranges are different.

■ Dual display and direct setting

The dual display allows you to check current and threshold values simultaneously.

To facilitate setting operations, three modes have been devised:

- › "RUN mode" is for operation settings that are carried out daily
- › "MENU SETTING mode" for basic settings
- › "PRO mode" for special and detailed settings

Controllers can be connected to a master controller one by one, and the master can transmit settings to the slave controllers. This significantly reduces time required when you need to make multiple, identical settings, or during production changeovers. Moreover, it reduces the possibility for error in such cases.

■ Direct installation using a hexagonal wrench

The sensor head is tightened with a hexagonal wrench, making installation easy, especially in tight spaces.



Typical applications

Leak test



Reference pressure checking



Monitoring vacuum pressure

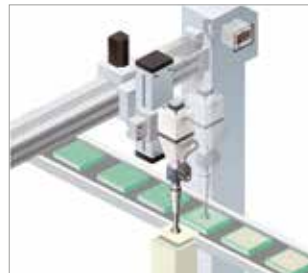

Technical specifications

Sensor heads

Type	Standard ±1bar (±100kPa)			Positive pressure +1bar (+1.0MPa)		Vacuum pressure -1bar (-100kPa)		
Model no.	DPH-101	DPH-101-M3	DPH-101-M5	DPH-102	DPH-102-M5	DPH-103	DPH-103-M3	DPH-103-M5
Type of pressure	Gauge pressure (note 1)							
Rated pressure	-1 to +1bar (-100.0 to +100.0kPa)			0 to 10bar (0 to +1.0MPa)		0 to -1bar (0 to -100.0kPa)		
Pressure resistance	5bar (500kPa)			15bar (1.5MPa)		5bar (500kPa)		
Applicable fluid	Air, non-corrosive gas							
Power supply	12 to 24VDC ±10%							
Analog voltage output	Output voltage: 1 to 5V (overrated pressure range)							
Protection	IP40 (IEC)							
Ambient temperature	0 to +50°C							
Pressure port	DPH-101 : R1/8 male thread + M5 female thread, DPH-101-M3 : M3 male thread (for installing gasket) DPH-101-M5 : M5 male thread (for installing gasket)							
Rated current consumption (without load)	Max. 15mA							
Material	Front case: PBT, Rear case: PBT (glass fiber reinforced), Pressure port: stainless steel (SUS303), O-ring: NBR, Pressure element silicon diaphragm, PPS							
Connection method	Cable, 2m with attached connector							
Dimensions (HxWxD)	23x13.2x 23.4mm	17x10x 20.5mm	17.5x10x 20.5mm	23x13.2x 23.4mm	17.5x10x 20.5mm	23x13.2x 23.4mm	17x10x 20.5mm	17.5x 10x 20.5mm
Accessories	Connector (e-CON): 1 pc.							

Controller

Type	NPN output	PNP output
Model no.	DPC-101	DPC-101-P
Applicable sensor head	DPH-101, DPH-102, DPH-103	
Rated pressure	Compound pressure type: -1 to +1bar (-100.0 to +100.0kPa) Positive pressure: 0 to 10bar (0 to +1.0MPa) Vacuum pressure: 0 to -1bar (0 to -100.0kPa)	
Power supply	12 to 24VDC ±10%	
Output	PNP or NPN open-collector transistor, max. 100mA	
Power consumption	Normal operation: max. 960mW (Current consumption max. 40mA at 24V supply voltage) ECO mode (STD): max. 720mW (Current consumption max. 30mA at 24V supply voltage) ECO mode (FULL): max. 600mW (Current consumption max. 25mA at 24V supply voltage) Excluding the current consumption of sensor head and analog output current	
Ambient temperature	-10 to +50°C	
Material	Enclosure: PBT (glass fiber reinforced), LCD display: Acrylic, Threaded part: Brass (nickel plated) Switch part: Silicon rubber	
Protection	IP40 (IEC)	
Connection method	Connector (note 2)	
Dimensions (HxWxD)	30x30x29.2mm	
Accessories	CN-66A-C2 Cable (2m) with attached connector Pressure unit label: 1 set	

Notes:

- Reference pressure 1atm
- CN-66A-C2** cable 2m is included in delivery

IO-Link
SensorsPhotoelectric
SensorsFiber-optic
Sensors

Standard Fibers

Fiber Sensors
Communication
Units

Mark Sensors

Laser Sensors

Safety Sensors

Pressure &
Flow SensorsInductive
Proximity
SensorsMeasurement
SensorsIonizers/
Electrostatic
Sensors

Accessories

DPC-100/
DPH-100

IO-Link
SensorsPhotoelectric
SensorsFiber-optic
Sensors

Standard Fibers

Fiber Sensors
Communication
Units

Mark Sensors

Laser Sensors

Safety Sensors

Pressure &
Flow SensorsInductive
Proximity
SensorsMeasurement
SensorsIonizers/
Electrostatic
Sensors

Accessories

DPC-L100/
DPH-L100

DPC-L100 / DPH-L100

Powerful and simple high-precision
detection of fluid and air pressure

Features

■ Head-separated sensor

The sensor head is very flexible and can be used with or without the control unit. High-precision measuring is possible with an analog current output of 1 to 5V and extremely accurate detection of 1% F.S.

■ Stainless steel construction

The enclosure is made of stainless steel and hence suitable in a wide range of applications. An oil-less, hermetically enclosed diaphragm prevents the fluids from being polluted. An integrated throttle controls the pressure and prevents damage by excess pressure.

■ Wide pressure ranges

Various sensor heads for different pressure ranges from vacuum pressure to positive pressure (up to 500bar/50MPa) are available. With the control unit, the pressure range can be output linearly as voltage or current.

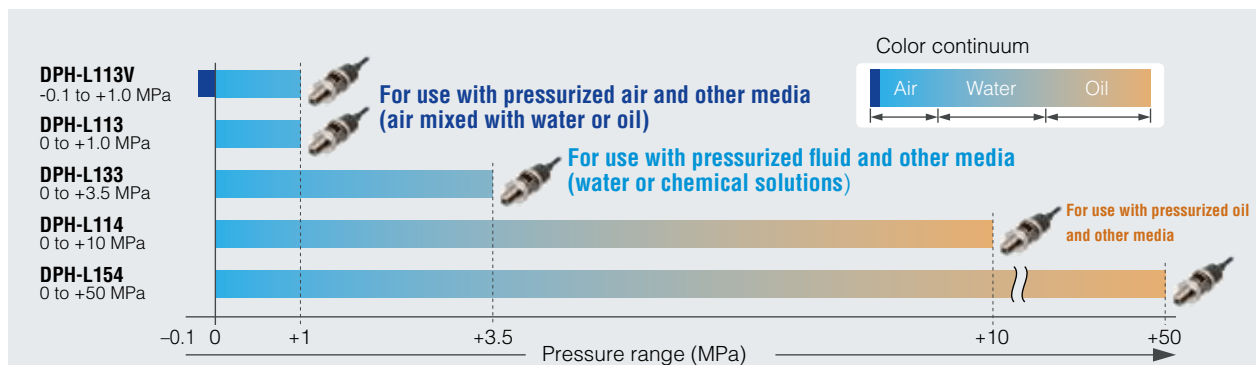
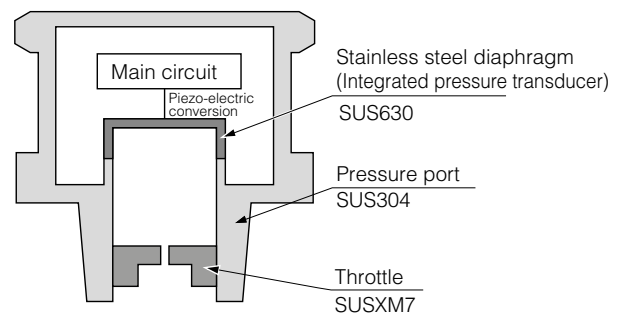

Typical applications

Transport of glass sheets after washing (pressurized air containing water droplets)



Management of plastic filling machine pressure (pressurized fluid)



Management of press pressure (pressurized oil)



Technical specifications

Sensor heads

Type	Compound pressure type		Positive pressure		
	DPH-L113V	DPH-L113	DPH-L133	DPH-L114	DPH-L154
Model no.	DPH-L113V	DPH-L113	DPH-L133	DPH-L114	DPH-L154
Rated pressure	-1 to +10bar (-0.1 to +1.0MPa)	0 to +10bar (0 to +1.0MPa)	0 to +35bar (0 to +3.5MPa)	0 to +100bar (0 to +10.0MPa)	0 to +500bar (0 to +50.0MPa)
Applicable fluid	Gases and fluids that do not corrode SUS630, SUS304, or SUSXM7				
Power supply	9 to 36VDC				
Analog voltage output	1 to 5VDC overrated pressure range, Accuracy (note): $\pm 1\%$ F.S. (at $23\pm 2^\circ\text{C}$)				
Response time	Max. 1ms				
Medium temperature range	-20 to +70°C			-20 to +125°C	
Pressure port	R1/4 male thread ((throttle embedded)				
Protection	IP67 (IEC)				
Ambient temperature	-20 to +70°C			-20 to +80°C	
Material	Diaphragm: stainless steel (SUS630); mounting threaded part: stainless steel (SUS304), Throttle: Stainless steel (SUSXM7)				
Connection method	Cable with connector enclosed, 2m				
Dimensions (ØxD)	24.3x73mm				
Accessories	e- CON connector 1pc.				

Note: Accuracy including linearity, hysteresis and repeatability

Controller

Type	NPN output	DPC-L101			
Model no.	PNP output	DPC-L101P			
Applicable sensor head	DPH-L113V	DPH-L113	DPH-L133	DPH-L114	DPH-L154
Rated pressure	-1 to +10bar (-0.1 to +1.0MPa)	0 to +10bar (0 to +1.0MPa)	0 to +35bar (0 to +3.5MPa)	0 to +100bar (0 to +10.0MPa)	0 to +500bar (0 to +50.0MPa)
Power supply	12 to 24VDC $\pm 10\%$				
Output	2 PNP or NPN open-collector transistors, max. 50mA				
Analog voltage output	Output voltage 1 to 5V Zero point: within $1V \pm 5\%$ F.S. (note 1) Span: $4V \pm 0.5\%$ F.S. Linearity: within $\pm 0.1\%$ F.S. Load impedance: approx. $1k\Omega$		Output current: 4 to 20mA Zero point: within $4mA \pm 1.0\%$ F.S. (note 2) Span: $16mA \pm 1.5\%$ F.S. Linearity: within $\pm 0.1\%$ F.S. Load resistance: max. $250k\Omega$		
Response time	5ms, 10ms, 25ms, 50ms, 100ms, 250ms, 500ms, 1000ms, 5000ms selectable by key operation				
Protection	IP40 (IEC)				
Ambient temperature	-10 to +50°C				
Material	Enclosure: PBT, LCD display: acrylic; Mounting threaded part: brass (nickel plated), Switch part: silicone rubber				
Connection method	Connector				
Dimensions (HxWxD)	30x30x25.5mm				
Accessories	CN-66A-C2 Cable, 2m with connector attached, Pressure unit label: 1 set				

Notes:

- 1.) DPH-L113V: Zeropoint within $1.364V \pm 0.5\%$ F.S.
- 2.) DPH-L113V: Zeropoint within $5.465mA \pm 1.0\%$ F.S.

IO-Link
Sensors

Photoelectric
Sensors

Fiber-optic
Sensors

Standard Fibers

Fiber Sensors
Communication
Units

Mark Sensors

Laser Sensors

Safety Sensors

Pressure &
Flow Sensors

Inductive
Proximity
Sensors

Measurement
Sensors

Ionizers/
Electrostatic
Sensors

Accessories

DPC-L100/
DPH-L100

IO-Link
SensorsPhotoelectric
SensorsFiber-optic
Sensors

Standard Fibers

Fiber Sensors
Communication
Units

Mark Sensors

Laser Sensors

Safety Sensors

Pressure &
Flow SensorsInductive
Proximity
SensorsMeasurement
SensorsIonizers/
Electrostatic
Sensors

Accessories

FM-200

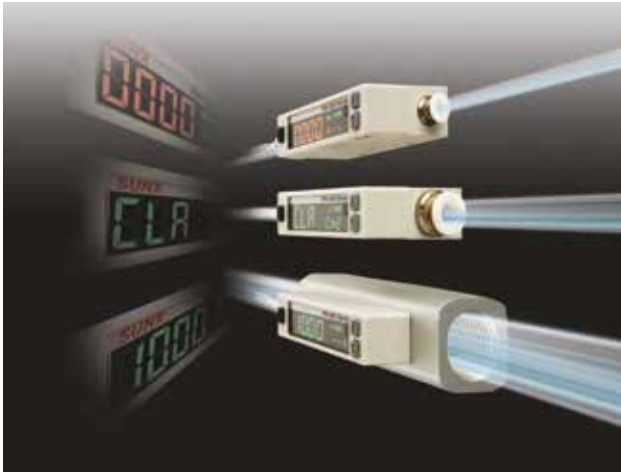

FM-200

Flow sensor with dual display

Features

■ Easy-to-read, 2-color display with sub display

The 2-color digital display lets you check the operation status of the **FM-200** at a glance. The use of color makes it easy to distinguish between measurement values and functionality.

■ High precision of $\pm 3\%$ F.S.

Micro Electro Mechanical System (MEMS) technology allows the sensor to be mounted on a silicon sensor chip. The advantages are as follows: an extremely small heat capacity, a high precision of $\pm 3\%$ F.S., and a high-speed response time. Two temperature sensors, one on either side of the heater, detect heat distribution and make bidirectional detection possible.

■ One sensor for both intake and exhaust

A single sensor can detect flows bidirectionally, or the forward or reverse direction only, making it suitable for a variety of applications.

■ Analog voltage output

1 to 5V analog voltage output is incorporated.

■ Integrated output and pulse output mode incorporated

The FM-200 series can control and manage flows for a wide variety of applications. The integrated output mode will turn the output ON or OFF at the specified integrated value, allowing you to control air blowing volumes, for example. In pulse output mode, a pulse is generated once at each specified integrated value, allowing you to monitor the amount of air consumed, for example with an ECO-POWER METER.

■ Integrated value reset function

In integrated mode, values accumulate over time. As soon as the limit is reached, the digital output is set. This limit value can also be reset by an external input.

■ Rattle prevention function

To prevent rattling from rapid changes in flow or from noise, the response time can be set to one of seven steps, from 50ms to approximately 1500ms. The display update period can be changed to 250ms, 500ms or 1000ms in order to eliminate flickering.

■ ECO mode

In ECO mode, the backlight is turned off after approximately one minute if no operation occurs to reduce power consumption.

Typical applications

Checking suction

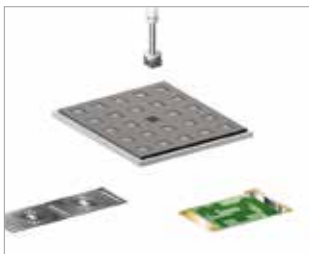

Checking seating



Monitoring air blowing and purge gas



Technical specifications

Type		Plastic housing					
Model no.	PNP output	FM-252-4-P	FM-213-4-P	FM-253-4-P	FM-214-4-P	FM-254-8-P	FM-215-8-P
	NPN output	FM-252-4	FM-213-4	FM-253-4	FM-214-4	FM-254-8	FM-215-8
Full scale flow rate		500ml/min	1.0l/min	5l/min	10l/min	50l/min	100l/min
Display range		±9999999ml		±99999.99l		±999999.9l	
Setting and display resolution		1ml/min		0.01l/min		0.1l/min	
Rated pressure		-0.9 to +7bar (-0.09 to +0.7MPa)					
Pressure resistance		10bar (1.0MPa)					
Applicable fluid		Clean air, compressed air, nitrogen gas					
Linearity		3%FS.					
Response time		50ms to 1.5s selectable					
Power supply		12 to 24VDC ±10%					
Output		PNP or NPN open-collector transistor, max. 50mA					
Output modes		Output OFF mode, window comparator mode, hysteresis mode, integrated output mode, integrated pulse output mode					
Analog voltage output		1.0 to 5.0V					
Rated current consumption (without load)		Normal mode: max. 60mA, ECO mode: max. 40mA					
Protection		IP40 (IEC)					
Ambient temperature		0 to +50°C					
Material		Plastic					
Connection method		Cable with connector enclosed, 1m					
Dimensions (HxWxD)		37x55x17mm				43x55x17mm	
Temperature characteristics		Within ±0.2% F.S./°C (+15°C to +35°C)					
Port size		ø4 push-in				ø8 push-in	

Type		Aluminum housing			
Model no.	PNP output	FM-255-AR2-P	FM-255-AG2-P	FM-216-AR2-P	FM-216-AG2-P
	NPN output	FM-255-AR2	-	FM-216-AR2	-
Full scale flow rate		500l/min		1000l/min	
Display range		±999999.9l			
Setting and display resolution		1l/min			
Rated pressure		-0.9 to +7bar (-0.09 to +0.7MPa)			
Pressure resistance		10bar (1.0MPa)			
Applicable fluid		Clean air, compressed air, nitrogen gas			
Linearity		3%FS.			
Response time		50ms to 1.5s selectable			
Power supply		12 to 24VDC ±10%			
Output		PNP or NPN open-collector transistor, max. 50mA			
Output modes		Output OFF mode, window comparator mode, hysteresis mode, integrated output mode, integrated pulse output mode			
Analog voltage output		1.0 to 5.0V			
Rated current consumption (without load)		Normal mode: max. 60mA, ECO mode: max. 40mA			
Protection		IP40 (IEC)			
Ambient temperature		0 to +50°C			
Material		Resin/Aluminum body type			
Connection method		Cable with connector enclosed, 1m			
Dimensions (HxWxD)		50x80x30mm			
Temperature characteristics		Within ±0.2% F.S./°C (+15°C to +35°C)			
Port size		Rc½ female thread	G½ female thread	Rc½ female thread	G½ female thread
Accessories		CN-F15-C1 cable, 1m with attached connector			

IO-Link
SensorsPhotoelectric
SensorsFiber-optic
Sensors

Standard Fibers

Fiber Sensors
Communication
Units

Mark Sensors

Laser Sensors

Safety Sensors

Pressure &
Flow SensorsInductive
Proximity
SensorsMeasurement
SensorsIonizers/
Electrostatic
Sensors

Accessories

FM-200

IO-Link
SensorsPhotoelectric
SensorsFiber-optic
Sensors

Standard Fibers

Fiber Sensors
Communication
Units

Mark Sensors

Laser Sensors

Safety Sensors

Pressure &
Flow SensorsInductive
Proximity
SensorsMeasurement
SensorsIonizers/
Electrostatic
Sensors

Accessories

GX-300



GX-300

Cylindrical inductive sensor with IO-Link

Features

High Response frequency

The **GX-303S** boasts a response frequency of 5 kHz and realizes high speed response. The response frequency of other sensor models has been also improved by up to 4 times as compared to our conventional models. Since the GX-300 series responds quickly to sensor ON/OFF judgement, it works well with a high-speed application and contributes to the reduction of equipment cycle time.



Indicator visible 360 degrees

In the small-diameter type sensors, the indicator light is visible at 4 locations. In the M8 and larger threaded type sensors, the high-brightness indicator and the resin containing dispersing agent allow the confirmation of the indicator from any angle to facilitate the cumbersome adjustment of installation position. The green indicator flashes during IO-Link communication.

Small-diameter type

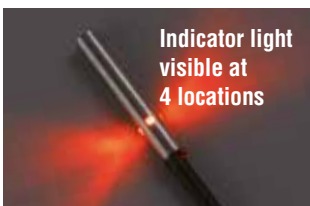

M8 / M12 / M18 / M30 threaded type



Type	Response frequency of our conventional model	Significant improvement over conventional models!	Response frequency of GX-300 standard sensing range type
ø3 mm	—		5 kHz (GX-303S)
ø4 mm* Conventional model: ø3.8 / ø4.4 mm	1 kHz	4 times	4 kHz (GX-304S)
ø5.4 mm	1.5 kHz	2.7 times	4 kHz (GX-305S)
M5 threaded	1 kHz	4 times	4 kHz (GX-305M)
M8 threaded	1 kHz	2 times	2 kHz (GX-308M)
M12 threaded	450 Hz	3.3 times	1,500 Hz (GX-312M)
M18 threaded	300 Hz	2 times	600 Hz (GX-318M)

Extensive line up

The **GX-300** series includes 310 different sensor models. We offer various types of sensor models such as the cable type (cable length: 2m or 5m) connector type and pigtailed type. Furthermore, we can supply bending-resistant cable type models (cable length : 2m or 5m), which are suitable for installation on moving parts.

Cable type



Connector type



Pigtailed type



IOT ready

With the implemented IO-Link technology network integration is easy. The IO-Link models can be used as normal digital PNP output sensors or providing information about the sensor level

or the current sensor condition via IO-Link interface. This is perfect for predictive maintenance and applications with higher expectations.

Typical applications



IO-Link Sensors

Photoelectric Sensors

Fiber-optic Sensors

Standard Fibers

Fiber Sensors Communication Units

Mark Sensors

Laser Sensors

Safety Sensors

Pressure & Flow Sensors

Inductive Proximity Sensors

Measurement Sensors

Ionizers / Electrostatic Sensors

Accessories

Technical specifications

DC 3-wire type (Small-diameter, shielded type)

Type		Non-threaded type			Threaded type
Model No. (note 2)	Normally Open	GX-303S-A-□	GX-304S-A-□	GX-305S-A-□	GX-305M-A-□
	Normally closed	GX-303S-B-□	GX-304S-B-□	GX-305S-B-□	GX-305M-B-□
Rated sensing distance		0.8mm	1.0mm	1.2mm	1.0mm
Stable sensing distance (note 3)		0 to 0.56mm	0 to 0.84mm	0 to 0.7mm	0 to 0.84mm
Standard sensing object (note 7)		3x3mm	4x4mm	5.4x5.4mm	4x4mm
Hysteresis		Max. 15% of measurement distance			
Supply voltage (note 4)		10-30V DC ±10% (note1)			
Current consumption		max. 10mA			
Control output		PNP / NPN open-collector transistor, 100mA (note2)			
Response Frequency (note 5)		5kHz		4kHz	
Protection		IP67 (IEC)			
Ambient temperature		-25 to +70°C			
Dimension (HxWxD)		Ø3x27.1mm	Ø4x25.1mm	Ø5.4x25.1mm	M8x25.1mm
Material		Case: Stainless steel (SUS303) [Brass (Nickel plated) for GX-305S], Sensing part: Heat-resistant ABS			
Connection method (note 6)		Cable, 2m or 5m; M12 connector type; pigtail type			

Notes:

- Where measurement conditions have not been specified precisely, the conditions ambient temperature +23°C
- Suffix -N =NPN type, Suffix -P = PNP type
- The specified stable sensing distance is the range in which the sensor works reliably even in case of deviations in temperature or voltage
- When used at a power of 12 V, the product is less susceptible to the effects of internal self-heat generation and therefore a more stable repeat accuracy can be obtained
- The response frequency is an average value.
- Suffix -C5 = 5m cable
Suffix -J = Pigtail 0.3m with M12 connector
Suffix -Z = M12 connector type
- Standard sensing object = sheet steel, thickness: 1mm

GX-300

DC 3-wire type (Shielded type)

Type		Threaded type			
Model No. (note 2)	Normally Open	GX-308M-A-□	GX-312M-A-□	GX-318M-A-□	GX-330M-A-□
	Normally closed	GX-308M-B-□	GX-312M-B-□	GX-318M-B-□	GX-330M-B-□
Rated sensing distance		1.5mm	2.0mm	5mm	10mm
Stable sensing distance (note 3)		0 to 1.2mm	0 to 1.6 mm	0 to 4 mm	0 to 8mm
Standard sensing object (note 7)		8x8mm	12x12mm	18x18mm	30x30mm
Hysteresis		Max. 10% of measurement distance			
Supply voltage (note 4)		10-30V DC ±10% (note1)			
Current consumption		max. 16mA			
Control output		PNP / NPN open-collector transistor, 200mA (note 2)			
Switching and communication line (C/Q) (note 8)	Communication specification	IO-Link specification V1.1			
	Baud rate	COM3 (230.4kbit/s)			
	Process data	PD size: 2 bytes, OD size: 1 byte (M-sequence type: TYPE2_2)			
	Transmission cycle time	0.4ms			
Response Frequency (note 5)		2kHz	1.5kHz	0.6kHz	0.4kHz
Protection		IP67 (IEC)			
Ambient temperature		-40 to +85°C			
Dimension (HxWxD)		M8x37.8mm	M12x47.1mm	M18x55.3mm	M30x60.3mm
Material		Case: Nickel-plated brass [stainless steel (SUS303) for GX-308M(K)-□], Sensing part: Polybutylene terephthalate (PBT)			
Connection method (note 6)		Cable, 2m or 5m; M12 connector type; pigtail type			

Notes:

- Where measurement conditions have not been specified precisely, the conditions ambient temperature +23°C
- Suffix -N = NPN type, Suffix -P = PNP type
- The specified stable sensing distance is the range in which the sensor works reliably even in case of deviations in temperature or voltage
- When used at a power of 12 V, the product is less susceptible to the effects of internal self-heat generation and therefore a more stable repeat accuracy can be obtained
- The response frequency is an average value.
- Suffix -C5 = 5m cable / Suffix -J = Pigtail 0.3m with M12 connector / Suffix -Z = M12 connector type
- Standard sensing object = sheet steel, thickness: 1mm
- IO-Link type only integrated in Normally open and PNP types = **GX-3□M-A-P**

DC 3-wire type (Non-shielded type)

Type		Threaded type			
Model No. (note 2)	Normally Open	GX-308ML-A-□	GX-312ML-A-□	GX-318ML-A-□	GX-330ML-A-□
	Normally closed	GX-308ML-B-□	GX-312ML-B-□	GX-318ML-B-□	GX-330ML-B-□
Rated sensing distance		2.0mm	5.0mm	10mm	18mm
Stable sensing distance (note 3)		0 to 1.6 mm	0 to 4 mm	0 to 8 mm	0 to 14.4 mm
Standard sensing object (note 7)		8x8mm	12x12mm	18x18mm	30x30mm
Hysteresis		Max. 10% of measurement distance			
Supply voltage (note 4)		10-30V DC ±10% (note1)			
Current consumption		max. 16mA			
Control output		PNP / NPN open-collector transistor, 200mA (note 2)			
Switching and communication line (C/Q) (note 8)	Communication specification	IO-Link specification V1.1			
	Baud rate	COM3 (230.4kbit/s)			
	Process data	PD size: 2 bytes, OD size: 1 byte (M-sequence type: TYPE2_2)			
	Transmission cycle time	0.4ms			
Response Frequency (note 5)		1kHz	0.8kHz	0.4kHz	0.1kHz
Protection		IP67 (IEC)			
Ambient temperature		-40 to +85°C			
Dimension (HxWxD)		M8x37.8mm	M12x47.1mm	M18x55.3mm	M30x60.3mm
Material		Case: Nickel-plated brass [stainless steel (SUS303) for GX-308ML(K)-□], Sensing part: Polybutylene terephthalate (PBT)			
Connection method (note 6)		Cable, 2m or 5m; M12 connector type; pigtail type			

Notes:

- Where measurement conditions have not been specified precisely, the conditions ambient temperature +23°C
- Suffix -N = NPN type, Suffix -P = PNP type
- The specified stable sensing distance is the range in which the sensor works reliably even in case of deviations in temperature or voltage
- When used at a power of 12 V, the product is less susceptible to the effects of internal self-heat generation and therefore a more stable repeat accuracy can be obtained
- The response frequency is an average value.
- Suffix -C5 = 5m cable / Suffix -J = Pigtail 0.3m with M12 connector / Suffix -Z = M12 connector type
- Standard sensing object = sheet steel, thickness: 1mm
- IO-Link type only integrated in Normally open and PNP types = **GX-3□ML-A-P**

DC 3-wire type (Shielded type, long sensing range)

Type		Threaded type			
Model No. (note 2)	Normally Open	GX-308MK-A-□	GX-312MK-A-□	GX-318MK-A-□	GX-330MK-A-□
	Normally closed	GX-308MK-B-□	GX-312MK-B-□	GX-318MK-B-□	GX-330MK-B-□
Rated sensing distance		2.0mm	4.0mm	8mm	15mm
Stable sensing distance (note 3)		0 to 1.6mm	0 to 3.2mm	0 to 6.4mm	0 to 12mm
Standard sensing object (note 7)		8x8mm	12x12mm	18x18mm	30x30mm
Hysteresis		Max. 15% of measurement distance			
Supply voltage (note 4)		10-30V DC ±10% (note1)			
Current consumption		max. 16mA			
Control output		PNP / NPN open-collector transistor, 200mA (note 2)			
Switching and communication line (C/Q) (note 8)	Communication specification	IO-Link specification V1.1			
	Baud rate	COM3 (230.4kbit/s)			
	Process data	PD size: 2 bytes, OD size: 1 byte (M-sequence type: TYPE2_2)			
	Transmission cycle time	0.4ms			
Response Frequency (note 5)		1.5kHz	1.kHz	0.5kHz	0.25kHz
Protection		IP67 (IEC)			
Ambient temperature		-40 to +85°C			
Dimension (HxWxD)		M8x37.8mm	M12x47.1mm	M18x55.3mm	M30x60.3mm
Material		Case: Nickel-plated brass [stainless steel (SUS303) for GX-308M(K)-□] Sensing part: Polybutylene terephthalate (PBT)			
Connection method (note 6)		Cable, 2m or 5m; M12 connector type; pigtail type			

Notes:

- Where measurement conditions have not been specified precisely, the conditions ambient temperature +23°C
- Suffix -N = NPN type, Suffix -P = PNP type
- The specified stable sensing distance is the range in which the sensor works reliably even in case of deviations in temperature or voltage
- When used at a power of 12 V, the product is less susceptible to the effects of internal self-heat generation and therefore a more stable repeat accuracy can be obtained
- The response frequency is an average value.
- Suffix -C5 = 5m cable / Suffix -J = Pigtail 0.3m with M12 connector / Suffix -Z = M12 connector type
- Standard sensing object = sheet steel, thickness: 1mm
- IO-Link type only integrated in Normally open and PNP types = **GX-3□MK-A-P**

DC 3-wire type (Non-shielded type, long sensing range)

Type		Threaded type			
Model No. (note 2)	Normally Open	GX-308MLK-A-□	GX-312MLK-A-□	GX-318MLK-A-□	GX-330MLK-A-□
	Normally closed	GX-308MLK-B-□	GX-312MLK-B-□	GX-318MLK-B-□	GX-330MLK-B-□
Rated sensing distance		4mm	8mm	16mm	30mm
Stable sensing distance (note 3)		0 to 3.2 mm	0 to 6.4 mm	0 to 12.8 mm	0 to 24 mm
Standard sensing object (note 7)		12x12mm	24x24mm	48x48mm	90x90mm
Hysteresis		Max. 15% of measurement distance			
Supply voltage (note 4)		10-30V DC ±10% (note1)			
Current consumption		max. 16mA			
Control output		PNP / NPN open-collector transistor, 200mA (note 2)			
Switching and communication line (C/Q) (note 8)	Communication specification	IO-Link specification V1.1			
	Baud rate	COM3 (230.4kbit/s)			
	Process data	PD size: 2 bytes, OD size: 1 byte (M-sequence type: TYPE2_2)			
	Transmission cycle time	0.4ms			
Response Frequency (note 5)		1.5kHz	1.kHz	0.5kHz	0.25kHz
Protection		IP67 (IEC)			
Ambient temperature		-40 to +85°C			
Dimension (HxWxD)		M8x37.8mm	M12x47.1mm	M18x55.3mm	M30x82.3mm
Material		Case: Nickel-plated brass [stainless steel (SUS303) for GX-308M(K)-□] Sensing part: Polybutylene terephthalate (PBT)			
Connection method (note 6)		Cable, 2m or 5m; M12 connector type; pigtail type			

Notes:

- Where measurement conditions have not been specified precisely, the conditions ambient temperature +23°C
- Suffix -N = NPN type, Suffix -P = PNP type
- The specified stable sensing distance is the range in which the sensor works reliably even in case of deviations in temperature or voltage
- When used at a power of 12 V, the product is less susceptible to the effects of internal self-heat generation and therefore a more stable repeat accuracy can be obtained
- The response frequency is an average value.
- Suffix -C5 = 5m cable / Suffix -J = Pigtail 0.3m with M12 connector / Suffix -Z = M12 connector type
- Standard sensing object = sheet steel, thickness: 1mm
- IO-Link type only integrated in Normally open and PNP types = **GX-3□MLK-A-P**

IO-Link
SensorsPhotoelectric
SensorsFiber-optic
Sensors

Standard Fibers

Fiber Sensors
Communication
Units

Mark Sensors

Laser Sensors

Safety Sensors

Pressure &
Flow SensorsInductive
Proximity
SensorsMeasurement
SensorsIonizers/
Electrostatic
Sensors

Accessories

GX-300



GX-M

Cylindrical inductive sensors

Features

■ 2- and 3-wire types

The **GX-M** series consists of 2- and 3-wire types. The 3-wire type is available as a shielded or non-shielded type. The 2-wire type is available as a shielded type and long-range type (up to 15mm). Reduced wiring efforts and space-saving installation reduce costs.

■ Various cylinder and thread types

M8, M12, M18 and M30 types means the GX-M series can be used to solve a wide range of automation task. Space-saving, case-by-case integration in production lines, testing and manual work stations.

■ Several connection possibilities

You can connect the GX-M sensor with either a 2m cable or M12 plug-in connector.

■ Special applications

IP69K (DIN) and IP68 (IEC) types are also available, e.g. for use in machine systems, i.e. the food processing machinery.

Typical applications

Control drilling depth

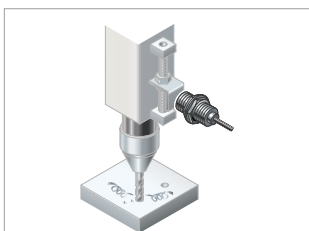

Detect how far press lowers

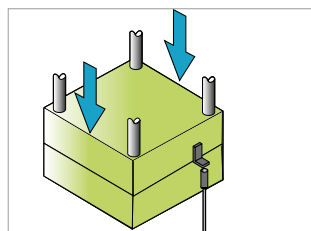

Count parts

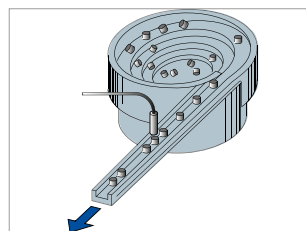

Control position of components

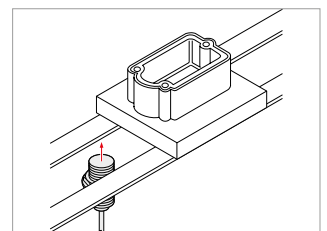

Technical specifications

3-wire type

Type	Shielded				Unshielded			
	GX-M8 (-A/-B)(-P)(-Z) (note 1,2,3)	GX-M12 (-A/-B)(-P)(-Z)	GX-M18 (-A/-B)(-P)(-Z)	GX-M30 (-A/-B)(-P)(-Z)	GX-MK12 (-A/-B)(-P)(-Z)	GX-MK18 (-A/-B)(-P)(-Z)	GX-MK30 (-A/-B)(-P)(-Z)	
Rated sensing distance (note 4)	1.5mm ±10%	2mm ±10%	5mm ±10%	10mm ±10%	7mm ±10%	12mm ±10%	22mm ±10%	
Stable sensing distance (note 5)	0 to 1.2mm	0 to 1.6mm	0 to 4mm	0 to 8mm	0 to 5.6mm	0 to 9.6mm	0 to 17.6mm	
Standard sensing object (note 6)	8x8mm	12x12mm	18x18mm	30x30mm	24x24mm	24x24mm	45x45mm	
Hysteresis	Max. 15% of measurement distance							
Repeatability	Along sensing axis: max. 5% of measurement distance							
Power supply	12 to 24VDC ±10%							
Output	Open collector transistor max. 200mA (note 2)							
Output operation	Normally closed (N.C.) or Normally open (N.O.) (note 1)							
Switching frequency	5kHz	5kHz	2kHz	1kHz	2.5kHz	1kHz	0.5kHz	
Protection	IP67 (IEC)	IP69K (DIN), IP68 (IEC) 2m cable type; IP67 (IEC) M12 connector type						
Ambient temperature	-25 to +70°C							
Material	Enclosure: Brass (nickel plated), Sensing part: PPS (polyphenylsulfide)							
Connection method	Cable, 2m or M12 plug-in connector type (note 3)							
Dimensions (ØxL)	2m cable	M8x33mm	M12x35mm	M18x39mm	M30x43mm	M12x55mm	M18x60mm	M30x63mm
	M12 connector	M8x45mm	M12x50mm	M18x50mm	M30x55mm	M12x66mm	M18x72mm	M30x74mm
Accessories	Nuts 2 pcs.							

Notes:

- 1.) Suffix-A = Normally open type, suffix B= Normally closed type; i.e. **GX-M8B**
- 2.) Suffix-P = PNP type, without suffix = NPN type; i.e. **GX-M8B**
- 3.) Without suffix = 2m cable, suffix -Z = M12 connector type; i.e. **GX-M8B-P-Z**
- 4.) The specified rated sensing distance refers to the standard sensing object
- 5.) The specified stable sensing distance is the range in which the sensor works reliably even in case of deviations in temperature or voltage
- 6.) Standard sensing object = sheet steel, thickness: 1mm

2-wire type

Type	Shielded								
	Standard sensing distance				Large sensing distance				
Model no.	GX-M8(-A/-B)-U (note 1, 2)	GX-M12(-A/-B)-U (-Z)	GX-M18(-A/-B)-U (-Z)	GX-M30(-A/-B)-U (-Z)	GX-ML8(-A/-B)-U	GX-ML12(-A/-B)-U (-Z)	GX-ML18(-A/-B)-U (-Z)	GX-ML30 (-A/-B)-U (-Z)	
Rated sensing distance (note 3)	1.5mm ±10%	2mm ±10%	5mm ±10%	10mm ±10%	2.5mm ±10%	4mm ±10%	8mm ±10%	15mm ±10%	
Stable sensing distance (note 4)	0 to 1.2mm	0 to 1.6mm	0 to 4mm	0 to 8mm	0 to 2mm	0 to 3.2mm	0 to 6.4mm	0 to 12mm	
Standard sensing object (note 5)	8x8mm	12x12mm	18x18mm	30x30mm	8x8mm	12x12mm	18x18mm	30x30mm	
Hysteresis	Max. 15% of measurement distance								
Repeatability	Along sensing axis: max. 5% of measurement distance								
Power supply	12 to 24VDC ±10%								
Output	Non-contact DC 2-wire type, sink current 1.5 to 100mA, residual voltage max 4.2V (note 6)								
Output operation	Normally closed (N.C.) or Normally open (N.O.) (note 1)								
Switching frequency	1kHz	1kHz	1.2kHz	1.3kHz	1.1kHz	1.3kHz	1.5kHz	0.8kHz	
Protection	IP67 (IEC)	IP69K (DIN), IP68 (IEC) 2m cable type; IP67 (IEC) M12 connector type							
Ambient temperature	- 25 to +70°C								
Material	Enclosure: Brass (nickel plated), Sensing part: PPS (polyphenylsulfide)								
Connection method	Cable, 2m	Cable, 2m or M12 plug-in connector type (note 2)			Cable, 2m	Cable, 2m or M12 plug-in connector type (note 2)			
Dimensions (ØxL)	2m cable	M8x33mm	M12x35mm	M18x39mm	M30x43mm	M8x33mm	M12x35mm	M18x39mm	M30x43mm
	M12 connector	-	M12x50mm	M18x50mm	M30x55mm	-	M12x50mm	M18x50mm	M30x55mm
Accessories	Nuts 2 pcs.								

Notes:

- 1.) Suffix-A = Normally open type, suffix B= Normally closed type; i.e. **GX-M8B-U**
- 2.) Without suffix = 2m cable, suffix -Z = M12 connector type; i.e. **GX-M8B-P-Z**
- 3.) The specified rated sensing distance refers to the standard sensing object
- 4.) The specified stable sensing distance is the range in which the sensor works reliably even in case of temperature or voltage deviations
- 5.) Standard sensing object = sheet steel, thickness: 1mm
- 6.) If you extend the cable residual voltage may rise

IO-Link Sensors

Photoelectric Sensors

Fiber-optic Sensors

Standard Fibers

Fiber Sensors Communication Units

Mark Sensors

Laser Sensors

Safety Sensors

Pressure & Flow Sensors

Inductive Proximity Sensors

Measurement Sensors

Ionizers / Electrostatic Sensors

Accessories

GX-M



GX-F/H

Stable sensing of work pieces

Features

■ Environmental resistance

This sensor has a long stable sensing range. It is easy to install.

- › IP68g protection: water and oil-resistant
- › Space-saving installation
- › A metal sleeve ensures a secure installation

The new, integrated construction method improves environmental resistance performance.

■ The LED indicators are easy to see

A prism with a wide field of view has been developed, thereby greatly improving the visibility of the operation indicators.

■ Stable detection

- › Large sensing range
- › Max. deviation at max. sensing range: $\pm 8\%$
- › Max. deviation with temperature changes: $\pm 8\%$

Typical applications

Checking up/down operation of compact molding equipment

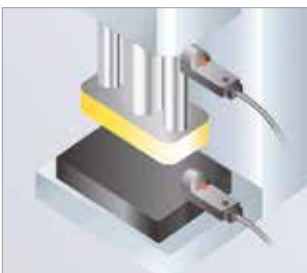

Shock resistance: 5000G

Sensing presence of metallic objects on a part feeder



Vibration resistance: 500Hz

Positioning metal pallets

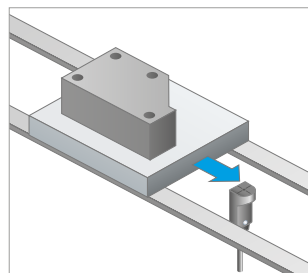

Muting control with light curtains

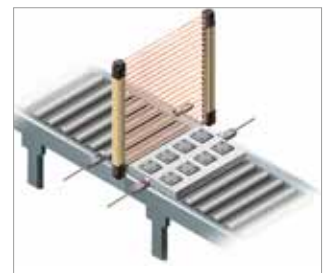

Technical specifications

Model no.	Side sensing	GX-F6 (-A/-B)(-I)(-P) (note 1,2,3)	GX-F8 (-A/-B)(-I)(-P)	GX-F12 (-A/-B)(-I)(-P)	GX-F15(-A/-B)(-I)(-P)	GX-FL15 (-A/-B)(-I)(-P)
	Top sensing	GX-H6 (-A/-B)(-I)(-P)	GX-H8 (-A/-B)(-I)(-P)	GX-H12 (-A/-B)(-I)(-P)	GX-H15 (-A/-B)(-I)(-P)	GX-HL15 (-A/-B)(-I)(-P)
Max. operating distance (note 4)		1.6mm ±8%	2.5mm ±8%	4mm ±8%	5mm ±8%	8mm ±8%
Stable sensing distance (note 5)		0 to 1.3mm	0 to 2.1mm	0 to 3.3mm	0 to 4.2mm	0 to 6.7mm
Standard sensing object (note 6)		12x12mm	15x15mm	20x20mm	20x20mm	30x30mm
Repeatability	Min. 0.04mm					
Interference prevention	Alternate frequency (note 2)					
Power supply	12 to 24V DC +10% / -15%					
Output	PNP / NPN open-collector transistor, 100mA (note 3)					
Output operation	Normally closed (NC) or Normally open (NO) (note 1)					
Switching frequency	400Hz	500Hz		250Hz	150Hz	
Protection	IP68 (IEC)					
Ambient temperature	-25 to +70°C					
Material	Enclosure: PBT, display: polyester					
Connection method	Cable, 1m					
Dimensions (HxWxD)	Side sensing	6x6x24.5mm	7.4x8x23mm	7.1x12x27.8mm	8x15x31.5mm	
	Top sensing	6x6x25mm	8.2x8x25mm	12x12x27.4mm	16.5x15x29.5mm	

Notes:

- 1.) Suffix-A = Normally open type, suffix B= Normally closed type; i.e. **GX-F6B**
- 2.) Suffix-I = Alternate frequency type (interference prevention) i.e. **GX-F6BI**
- 3.) Without suffix = NPN type, P = PNP type; i.e. **GX-F6BI-P**
- 4.) The specified rated sensing distance refers to the standard sensing object
- 5.) The specified stable sensing distance is the range in which the sensor works reliably even in case of temperature or voltage deviations
- 6.) Standard sensing object = sheet steel, thickness: 1mm

IO-Link
SensorsPhotoelectric
SensorsFiber-optic
Sensors

Standard Fibers

Fiber Sensors
Communication
Units

Mark Sensors

Laser Sensors

Safety Sensors

Pressure &
Flow SensorsInductive
Proximity
SensorsMeasurement
SensorsIonizers/
Electrostatic
Sensors

Accessories

GX-F/H

IO-Link
SensorsPhotoelectric
SensorsFiber-optic
Sensors

Standard Fibers

Fiber Sensors
Communication
Units

Mark Sensors

Laser Sensors

Safety Sensors

Pressure &
Flow SensorsInductive
Proximity
SensorsMeasurement
SensorsIonizers/
Electrostatic
Sensors

Accessories

HG-S



HG-S

Slim and robust contact
measurement sensor

Features

■ Larger measurement range

The new sensor head **HG-S1032** has a measurement range of 32mm with an indication accuracy of 3µm. All types are equipped with two plain bearings, one at the top and one at the bottom. The sensor can withstand more than 100 million sliding operations under application of lateral load (reference value). The two plain bearings increase the resistance to mechanical stress from the side and ensure the accuracy of measuring results even under lateral load.

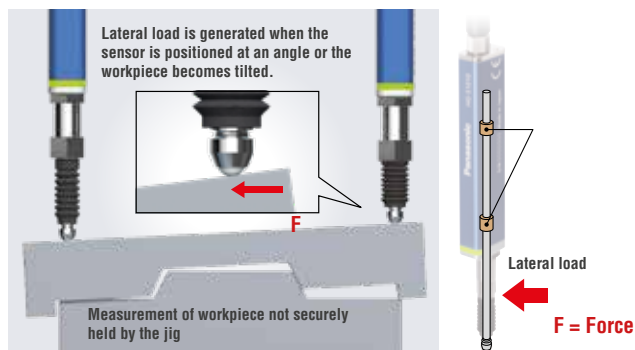

■ Spindle stopper against damage

Even when a sudden upward thrust impact occurs, the resulting load is applied only to the lower section of the sensor unit because a spindle stopper minimizes the impact on the glass scales. Additionally an alarm can be set to notify the user of an upward thrust (stroke) that exceeds the set level. This allows you to conduct a preventive maintenance before the sensor head generates a malfunction.

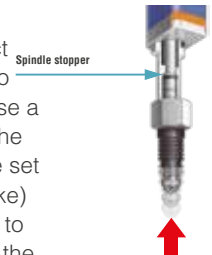

■ Easy-to-understand 2-line digital display

The 2-line digital display simultaneously shows head measurement (measured value) and judgment value (calculated value). The high-contrast LCD provides sharp and clear indications and offers a wide viewing angle. Secondary display line: Displays sensor head measurement and other data. Main display line: displays judgment value.



- 1.) Dual display for more flexibility
- 2.) Copy function from master to slave units

■ Serial connection of up to 15 slave units

One master unit can be connected in series with up to 15 slave units in any order. This allows easy multi-point calculations. End plates (optional) must be mounted on both sides of the controller after the connection of slave units.



Typical applications

Coupling assembly inspection



Transmission parts height measurement



Flat screen flatness measurement

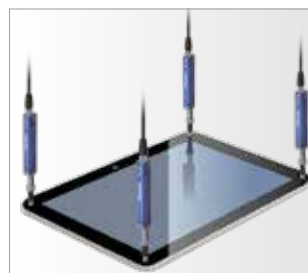

Technical specifications

Sensor heads

Type	General purpose			High precision			General purpose	
	Standard type	Low measuring force type	Air driven type	Standard type	Low measuring force type	Air driven type	Standard type	
Model no.	HG-S1010	HG-S1010R	HG-S1010-AC	HG-S1110	HG-S1110R	HG-S1110-AC	HG-S1032	
Measurement range	10mm (note 1)						32mm	
Measuring force (note 2, note 3)	Downward mount	Max. 1.65N, 1.1N (note 4)	Max. 0.35N, 0.3N (note 4)	0.14 to 0.16 MPa Dependent on applied pressure	Max. 1.65N, 1.1N (note 4)	Max. 0.35N, 0.3N (note 4)	0.14 to 0.16 MPa Dependent on applied pressure	Max. 2.97N, 1.90N (note 4)
	Upward mount	Max. 1.35N, 0.85N (note 4)	–		Max. 1.35N, 0.85N (note 4)	–		Max. 2.09N, 1.19N (note 4)
	Side mount	Max. 1.5 N, 0.95N (note 4)	Max. 0.25N, 0.2N (note 4)		Max. 1.5 N, 0.95N (note 4)	Max. 0.25N, 0.2N (note 4)		Max. 2.53 N, 1.50N (note 4)
Resolution	0.5µm			0.1µm			0.5µm	
Accuracy	Full range: max. 2.0µm Narrow range: max. 1.0µm (any 60µm)		Full range: 2.0 µm, Limited range: 1.0 µm	Full range: max. 1.0µm Narrow range: max. 0.5µm (any 60µm)		Full range: 1.0 µm Limited range: 0.5 µm	Full range: max. 3.0 µm Narrow range: max. 2.0µm (any 60µm)	
Protection	IP67 (IEC, note 5)		IP67 (IEC) (Note 8)	IP67 (IEC, note 5)		IP67 (IEC) (Note 8)	IP67 (IEC, note 5)	
Ambient temperatur	-10 to +55°C							
Material	Body: zinc, holder: stainless steel; spindle: tool steel; probe (note 6): ceramic; rubber bellows: NBR (black)		Body: zinc, holder: stainless steel, spindle: tool steel, probe (note 7): ceramic, Air tube clamp: S60CM	Body: zinc, holder: stainless steel; spindle: tool steel; probe (note 6): ceramic; rubber bellows: NBR (black)		Body: zinc, holder: stainless steel, spindle: tool steel, probe (note 7): ceramic, Air tube clamp: S60CM	Body: zinc, holder: stainless steel; spindle: tool steel; probe (note 6): ceramic; rubber bellows: NBR (black)	
Connection method	Connector (note 7)							
Dimensions (HxWxD)	135.5x11x18mm		125x11x18mm	135.5x11x18mm		125x11x18mm	217x17.5x27mm	

Notes:

- 1.) 5 to 10mm range when low measurement force type (HG-S1010R / HG-S1110R / HG-S1032) is mounted in upward mount
- 2.) Measured at an ambient temperature of +20°C
- 3.) In the case of low measuring force type (HG-S1010R / HG-S1110R), measurements were obtained with products in standard configuration without rubber bellows
- 4.) Typical value near center of measurement
- 5.) Excludes damage and deterioration to rubber bellows due to external causes
- 6.) Different probes (optional) are also available
- 7.) Please order sensor head connection cable separately
- 8.) Seal Cap has to be applied

Controllers

Type	Master unit		Slave unit	
	High-performance type		Standard type	
Model no.	NPN output	HG-SC101	HG-SC111	HG-SC112
	PNP output	HG-SC101-P	HG-SC111-P	HG-SC112-P
Supply voltage	24V DC ±10% (note1)			
Current consumption (note 2)	Max. 70mA when sensor head is connected			
Response time	3ms, 5ms, 10ms, 100ms, 500ms, 1000ms switching type			
Control output	NPN or PNP open collector transistor, max. 50 mA			
Analog output (note 3)	4-20mA			
Protection	IP40 (IEC)			
Ambient temperature	-10 to +50°C			
Dimension (HxWxD)	43.1x86x21.1mm			
Material	Case: Polycarbonate, Cover: Polycarbonate, Switches: Polyacetal			
Connection method	Cable, 2m			

Notes:

- 1.) Where measurement conditions have not been specified precisely, the conditions used were as follows: supply voltage 24 V DC, ambient temperature +20°C
- 2.) Current consumption does not include analog current output
- 3.) Linearity F.S. = 16 mA, and is linearity with respect to digitally measured values

Sensor head connection cable

Type	Straight connector			L-shaped connector		
	CN-HS-C3	CN-HS-C7	CN-HS-C7	CN-HS-C3L	CN-HS-C7L	CN-HS-C20L
Model no.						
						
Length	3m	7m	20m	3m	7m	20m

10-Link Sensors

Photoelectric Sensors

Fiber-optic Sensors

Standard Fibers

Fiber Sensors Communication Units

Mark Sensors

Laser Sensors

Safety Sensors

Pressure & Flow Sensors

Inductive Proximity Sensors

Measurement Sensors

Ionizers / Electrostatic Sensors

Accessories

HG-S



HG-C

Reliable detection with repeatability of 10 μ m

Features

Equipped with 0-5V analog output

The sensor not only indicates measured values in mm, but also outputs analog voltage. The data can be used for various calculations and storage (logging) when the output is sent to a PLC + analog unit.

Configurable external input

The external input can be configured to perform one of four functions: "zero set", "teaching", "emission stop" and "selecting trigger function".

Teaching & window comparator mode

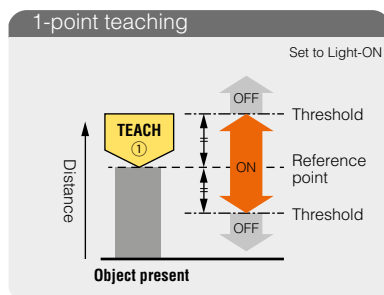

Perform 1-point teaching and the threshold range is set for the distance from the reference surface of the object to be detected.

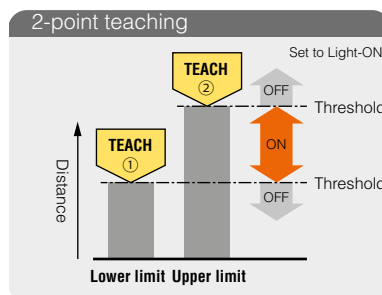

Press TEACH once for the lower (first point) and once for the upper limit (second point). This is useful for detecting objects at different distances.

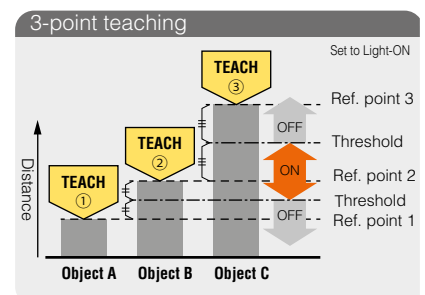

This is the method to set the threshold range by conducting the teaching at 3 points (detecting object A, B and C). After teaching, the reference points are automatically sorted in ascending order (reference point 1, 2 and 3). The thresholds are set at the midpoints between reference point 1 and 2, and 2 and 3, respectively. This is useful for detecting objects at different distances.

Typical applications

Measuring the hoop slack

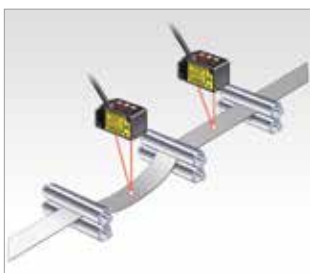

Checking for presence of O ring



Controlling the height of a robot

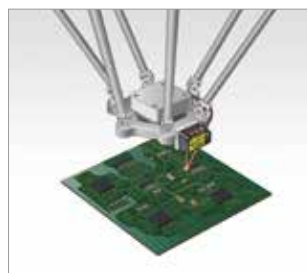

Controlling the dispenser head height



Technical specifications

Measurement center type	30mm	50mm	100mm	200mm	400mm
NPN output	HG-C1030	HG-C1050	HG-C1100	HG-C1200	HG-C1400
PNP output	HG-C1030-P	HG-C1050-P	HG-C1100-P	HG-C1200-P	HG-C1400-P
Applicable standards	Conforming to EMC Directive and FDA Standard				
Sensing range	30±5mm	50±15mm	100±35mm	200mm ±80mm	400mm ±200mm
Repeatability	10µm	30µm	70µm	200µm	300µm (200-400mm) 800µm (400-600mm)
Linearity	±0.1% F.S.			±0.2% F.S.	±0.2% F.S. (200-400mm) ±0.3% F.S. (400-600mm)
Beam diameter	Approx. 50µm	Approx. 70µm	Approx. 120µm	Approx. 300µm	Approx. 500µm
Supply voltage	12 to 24V DC ±10%				
Control output	PNP or NPN open-collector transistor				
Output operation	Either Light-ON or Dark-ON				
Short circuit protection	Incorporated (auto-reset)				
Analog output	Voltage output: 0 to 5V (at alarm: +5.2V). Load impedance: 100Ω Analog current output: Output range: 4 to 20mA (at alarm: 0mA) Output impedance: 300Ω or less				
Response time	Switchable between high speed (1.5ms), standard (5ms), and high precision (10ms)				
Degree of protection	IP67 (IEC)				
Ambient temperature	-10 to +45°C (no dew condensation or icing allowed), storage: -20 to +60°C				
Ambient humidity	35 to 85% RH, at storage: 35 to 85% RH				
Ambient illumination	3000lx max. (Illumination level of light receiving surface under incandescent light)				
Cable	5-core cable, 2m				
Material	Enclosure: die-cast aluminum, front cover: acrylic				
Dimensions (HxWxD)	44x20x25mm				

IO-Link
SensorsPhotoelectric
SensorsFiber-optic
Sensors

Standard Fibers

Fiber Sensors
Communication
Units

Mark Sensors

Laser Sensors

Safety Sensors

Pressure &
Flow SensorsInductive
Proximity
SensorsMeasurement
SensorsIonizers/
Electrostatic
Sensors

Accessories

HG-C

IO-Link
SensorsPhotoelectric
SensorsFiber-optic
Sensors

Standard Fibers

Fiber Sensors
Communication
Units

Mark Sensors

Laser Sensors

Safety Sensors

Pressure &
Flow SensorsInductive
Proximity
SensorsMeasurement
SensorsIonizers/
Electrostatic
Sensors

Accessories

HL-G1



HL-G1

Precision laser displacement
sensors

Features

All-In-One Concept

All processing electronics are incorporated in a robust sensor housing. All settings can be made directly on the sensor. A 7-segment LED-display makes it easy to configure sensor operation while checking displacement values.

Compact and lightweight body

With its lightweight plastic body, weighing just 70g and dimensions of 20.4 x 60 x 57mm, it is easy to integrate the sensor in machines and production lines where space is tight.

Extended product range

With the extension of the HL-G1 series it is now possible to measure on specular surfaces with a high accuracy. Models with different measurement distances up to 82mm are available. Suitable applications can be for example in the semiconductor industry with specular wafer surfaces or other polished metal parts.

User-friendly

The **HL-G1** series can be operated directly, by touch terminal (GT02/GT12 series) or Windows software via RS-422/RS-485.



Typical applications

Control of dispenser height

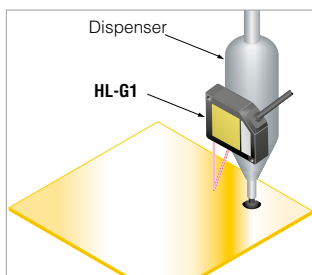

Detection of aluminum wheel grooves

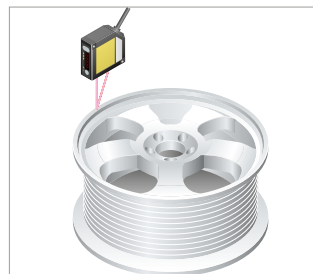

Measuring sheet slack and thickness

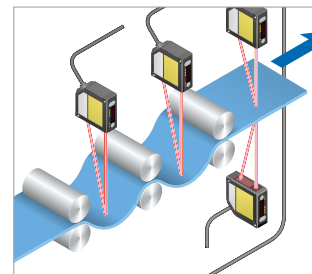

Measuring the eccentricity of a metal shaft



Technical specifications

Standard type

Type	Diffuse reflective type					Specular reflective type		
Model no.	HL-G103-A-C5	HL-G105-A-C5	HL-G108-A-C5	HL-G112-A-C5	HL-G125-A-C5	HL-G103-RA-C5	HL-G105-RA-C5	HL-G-RA-C5
Sensing range	30±4mm	50±10mm	85±20mm	120±60mm	250±150mm	26.3±2mm	47.3±5mm	82.9±10mm
Emission spot size	0.1x0.1mm	0.5x1mm	0.75x1.25mm	1.0x1.5mm	1.75x3.5mm	0.1x0.1mm		0.2x0.2mm
Power supply	24V DC ±10%							
Analog voltage output	0 to 10V / 4 to 20mA							
Response time	200µs, 500µs, 1ms, 2ms (selectable)							
Resolution	0.5µm	1.5µm	2.5µm	8µm	20µm	0.5µm	1.5µm	2.5µm
Linearity	±0.1%F.S.				±0.3%F.S.	±0.2%F.S.		
Emitting element	Red laser diode, 655nm (class 2)							
Output	PNP or NPN open-collector transistor, max. 50mA (selection by wiring)							
Protection	IP67 (IEC)							
Ambient temperature	-10 to +45°C							
Material	Enclosure: PBT / Front cover: Acrylic / Cable: PVC							
Connection method	Cable, 5m							
Dimensions (HxWxD)	60x20.4x57mm							
Accessories	Warning label (English): 1 set							

Multifunction type

Type	Diffuse reflective type					Specular reflective type		
Model no.	HL-G103-S-J	HL-G105-S-J	HL-G108-S-J	HL-G112-S-J	HL-G125-S-J	HL-G103-RS-J	HL-G105-RS-J	HL-G108-RS-J
Sensing range	30±4mm	50±10mm	85±20mm	120±60mm	250±150mm	26.3±2mm	47.3±5mm	82.9±10mm
Emission spot size	0.1x0.1mm	0.5x1mm	0.75x1.25mm	1.0x1.5mm	1.75x3.5mm	0.1x0.1mm		0.2x0.2mm
Power supply	24V DC ±10%							
Analog voltage output	0 to 10V / 4 to 20mA							
Interfaces	RS-485 / RS-422							
Response time	200µs, 500µs, 1ms, 2ms (selectable)							
Resolution	0.5µm	1.5µm	2.5µm	8µm	20µm	0.5µm	1.5µm	2.5µm
Linearity	±0.1%F.S.				±0.3%F.S.	±0.2%F.S.		
Emitting element	Red laser diode, 655nm (class 2)							
Output	PNP or NPN open-collector transistor, max. 50mA (selection by wiring)							
Protection	IP67 (IEC)							
Ambient temperature	-10 to +45°C							
Material	Enclosure: PBT / Front cover: Acrylic / Cable: PVC							
Connection method	Cable with connector, 0.5m (note)							
Dimensions (HxWxD)	60x20.4x57mm							
Accessories	Warning label (English): 1 set							

Note: Cable is not included in delivery. Please select under accessories (page 129)

IO-Link
SensorsPhotoelectric
SensorsFiber-optic
Sensors

Standard Fibers

Fiber Sensors
Communication
Units

Mark Sensors

Laser Sensors

Safety Sensors

Pressure &
Flow SensorsInductive
Proximity
SensorsMeasurement
SensorsIonizers /
Electrostatic
Sensors

Accessories

HL-G1

IO-Link
SensorsPhotoelectric
SensorsFiber-optic
Sensors

Standard Fibers

Fiber Sensors
Communication
Units

Mark Sensors

Laser Sensors

Safety Sensors

Pressure &
Flow SensorsInductive
Proximity
SensorsMeasurement
SensorsIonizers/
Electrostatic
Sensors

Accessories

HL-C2



HL-C2

Ultra high-speed, precision laser displacement sensors

Features

- **Excellent basic performance**
- **Sampling rate 100kHz**

The HDLC-CMOS sensors were developed especially for the **HL-C2** series. The high-resolution chip together with a very short processing time enables maximum resolution and speed.

- **Resolution up to 0.01 μ m, linearity up to $\pm 0.02\%$ F.S.**

Superior resolution of 0.01 μ m. Linearity of $\pm 0.02\%$ F.S. enabled by latest high resolution lens technology.

- **Compact but with a wide array of functions**

You can connect two sensor heads and a variety of devices to the ultra compact controller. Measurement values can be analyzed and displayed while the sensors are being controlled.

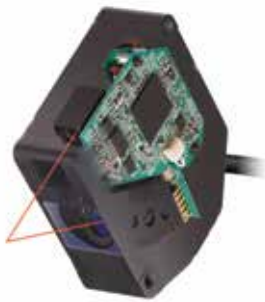

Typical applications

Measurement of the position of patterned glass

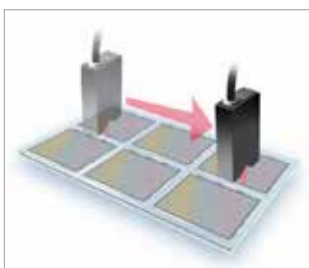

Control of the camera focus



Measurement of the shape of a camshaft



Measurement of the heights of chip parts



Specifications

Sensor heads

Measuring range	10±1mm				30±5mm			
Model no.	HL-C201F	HL-C201FE	HL-C201F-MK	HL-C201FE-MK	HL-C203F	HL-C203FE	HL-C203F-MK	HL-C203FE-MK
Type	Small beam spot type		Linear beam spot type		Small beam spot type		Linear beam spot type	
Measuring range	10±1 mm				30±5 mm (specular reflective mode 26.4±4.6mm)			
Resolution	0.01µm	0.25µm	0.01µm	0.25µm	0.025µm	0.25µm	0.025µm	0.25µm
Laser class	Class 1				Class 2			
Beam size	Ø20µm		20x700µm		Ø30µm		30x1200µm	
Linearity	±0.02% F.S.				±0.03% F.S.			
Dimensions (HxWxD)	54x20x95mm				80x26x70mm			

Measuring range:	50±5mm				85±20mm			
Model no.	HL-C205B (HL-C205BE, note 1)	HL-C205B-MK (HL-C205BE-MK, note 1)	HL-C205C (HL-C205CE, note 1)	HL-C205C-MK (HL-C205CE-MK, note 1)	HL-C208B (HL-C208BE, note 1)	HL-C208B-MK (HL-C208BE-MK, note 1)	HL-C208C (HL-C208CE, note 1)	HL-C208C-MK (HL-C208CE-MK, note 1)
Type	Spot type	Linear beam spot type	Spot type	Linear beam spot type	Spot type	Linear beam spot type	Spot type	Linear beam spot type
Measuring range	50±5mm (specular reflective mode 46±5mm) (note 2)				85±20 mm (specular reflective mode 81.4±6mm) (note 2)			
Resolution	0.05µm				0.15µm			
Laser class	Class 2		Class 3R		Class 2		Class 3R	
Beam size	Ø70µm	70x1000µm	Ø70µm	70x1000µm	Ø100µm	100x1200µm	Ø100µm	100x1200µm
Linearity	±0.03% F.S.				±0.03 % F.S. (specular reflective mode ±0.1 % F.S.)			
Dimensions	90x26x74mm							

Measuring range:	110±15mm							
Model no.	HL-C211F	HL-C211FE	HL-C211F5	HL-C211FE-MK	HL-C211F-MK	HL-C211FE-MK	HL-C211F5-MK	HL-C211F5E-MK
Type	Spot type				Linear beam spot type			
Measuring range	110±15mm (specular reflective mode 106±14.7mm) (note 2)							
Resolution	0.1µm	0.25µm	0.1µm	0.25µm	0.1µm	0.25µm	0.1µm	0.25µm
Laser class	Class 2		Class 3R		Class 2		Class 3R	
Beam size	Ø80µm				Ø80x1700µm			
Linearity	±0.03% F.S.							
Dimensions	90x26x74mm							

Measuring range:	350±200mm	
Model no.	HL-C235CE-W	HL-C235CE-WMK
Type	Spot type	Linear beam spot type
Measuring range	350±200 mm	
Resolution	2µm	
Laser class	Class 3R	
Beam size	Ø400µm	400x6500µm
Linearity	±0.04% F.S. (-200 to 0mm), ±0.08% F.S. (0 to +200mm)	
Dimensions	90x26x74mm	

Notes:

- Models with a minimum resolution of 0.25µm are subject to the Japanese export controls, defined in the "Foreign Exchange and Foreign Trade Act". This is not true for the model nos. in brackets if the laser heads are ordered in combination with a controller (i.e. HL-C2CE)
- If the light reflection in "specular reflective mode" is too high, please use the optional filter (HL-C2F01)

Common technical data

Emitting element	Red laser diode, 658nm
Degree of protection	IP67 (IEC)
Ambient temperature	0 to +45°C
Material	Enclosure: Die-cast aluminum / optical window: glass
Connection method	0.5m cable with attached connector (extension cables, see page 129 (HL-G1CCJ□))

Controllers

Type	RS232C interface				Ethernet interface			
	NPN		PNP		NPN		PNP	
	High resolution		Low resolution		High resolution		Low resolution	
Model no.	HL-C2C	HL-C2C-P	HL-C2CE	HL-C2CE-P	HL-C21C	HL-C21C-P	HL-C21CE	HL-C21CE-P
Supply voltage	24V DC (±10%)							
Analog output	±5V/F.S., 4-20mA F.S.							
Output	NPN or PNP open collector transistor, max 100mA							
Inputs	Timing input, zero set, remote interlock, reset							
USB interface	USB 2.0							
Serial input/output	RS232C (9.6-115.2kbps)							
Current consumption	With 1 sensor head: 350mA With 2 sensor heads: 500mA							
Ambient temperature	0 to +50°C							
Material	Polycarbonate							
Connection method	Connector (sensors), terminal block							
Dimensions (HxWxD)	130x59x105.5mm							

10-Link
SensorsPhotoelectric
SensorsFiber-optic
Sensors

Standard Fibers

Fiber Sensors
Communication
Units

Mark Sensors

Laser Sensors

Safety Sensors

Pressure &
Flow SensorsInductive
Proximity
SensorsMeasurement
SensorsIonizers/
Electrostatic
Sensors

Accessories

HL-C2

IO-Link
SensorsPhotoelectric
SensorsFiber-optic
Sensors

Standard Fibers

Fiber Sensors
Communication
Units

Mark Sensors

Laser Sensors

Safety Sensors

Pressure &
Flow SensorsInductive
Proximity
SensorsMeasurement
SensorsIonizers/
Electrostatic
Sensors

Accessories

HG-T



HG-T

Laser thru-beam sensor

Features

High precision

The laser thru-beam sensor of the HG-T series works with a belt-shaped laser beam with a width of 10mm for measuring an area, e.g. for checking the contours of an edge.

The sensor achieves a repeatability of $> 1\mu\text{m}$ and has a linearity of less than $\pm 12\mu\text{m}$ over the whole measurement range.

The thru-beam sensor has a sensing range of 500mm, which means that a larger variety of applications can be realized than with sensors with a shorter sensing range.

Flexible mounting

The HG-T series comes with two different sensor heads, which differ in their dimensions. The slim type receiver is 10mm less wide than the standard type and fits well into machines with very limited space.

Sensor heads



Standard type:

Emitter: 8x30x60mm (WxDxH)

Receiver: 8x30x60mm (WxDxH)



Slim type:

Emitter: 8x30x60mm (WxDxH)

Receiver: 8x20x60mm (WxDxH)

Optical features

Thanks to functions like filters, edge detection, light intensity checks and averaging of measurement values (up to 1024), the measurements are very reliable. These functions help you to detect at an early stage when the measuring process does not run smoothly anymore and the system needs to be modified.

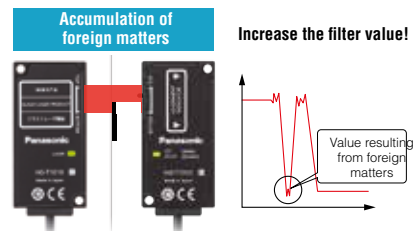

Easy installation of multiple sensors

The master-slave system makes it easy to connect up to 15 sensors in series. Another feature increasing ease-of-use is the possibility to copy settings from the master to the slave units. A LED indicates when copying is in progress.

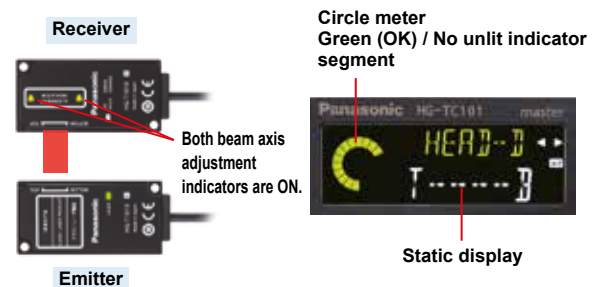

Typical applications

Highly precise measuring and checking of web edges



Measuring the flatness of glass sheets for transport

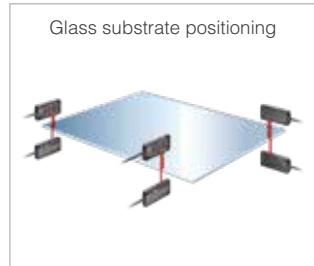

Measuring of diameters



Technical specifications

■ Sensor heads

Type	Standard type	Slim type
Model no.	HG-T1010	HG-T1110
Measurement range (width of laser belt)	10mm	
Measurement range	0 to 500mm	
Repeatability	max. 1µm	
Protection	IP67	
Ambient temperatur	-10 to +45°C	
Material	Housing: Die-cast aluminum, light emitting and receiving surfaces: Glass	
Connection method	cable with connector 0.2m (connection cable not included)	
Dimensions (HxWxD)	Emitter: 8x30x60mm Receiver: 8x30x60mm	Emitter: 8x30x60mm Receiver: 8x20x60mm

■ Controllers

Type	Master unit		Slave units		
Model no.	HG-TC101	HG-TC101-P	HG-TC111	HG-TC111-P	HG-TC113
Supply voltage	24V DC				
Current consumption (note)	Max. 100mA (when sensor head is connected)				
Sampling cycle	1ms (standard sampling) / 0.5ms (high-speed sampling)				
Control output	NPN or PNP open collector transistor, max. 50 mA				
Analog output (note 3)	4 to 20mA, 0 to 5V (Switchable)				
Protection	IP40				
Ambient temperature	-10 to +50°C				
Dimension (HxWxD)	43.1x21.1x86				
Material	Case: polycarbonate, cover: polycarbonate, keys: polyacetal				
Connection method	Connector				

Notes: Current consumption does not include analog current output

■ Sensor head connection cable The sensor head connection cable has to be ordered separately.

Model No.	CN-HT-C2	CN-HT-C5
Length	2m	5m

IO-Link
SensorsPhotoelectric
SensorsFiber-optic
Sensors

Standard Fibers

Fiber Sensors
Communication
Units

Mark Sensors

Laser Sensors

Safety Sensors

Pressure &
Flow SensorsInductive
Proximity
SensorsMeasurement
SensorsIonizers/
Electrostatic
Sensors

Accessories

HG-T

IO-Link
SensorsPhotoelectric
SensorsFiber-optic
Sensors

Standard Fibers

Fiber Sensors
Communication
Units

Mark Sensors

Laser Sensors

Safety Sensors

Pressure &
Flow SensorsInductive
Proximity
SensorsMeasurement
SensorsIonizers/
Electrostatic
Sensors

Accessories

GP-X



GP-X

Eddy current analog sensor for
high-speed sampling

Features

- Ultra high-speed response time of 25 μ s
- Extremely low temperature deviations (0,07% F.S. $^{\circ}$ C)
- Predefined material characteristics

The sensor exhibits $\pm 0.3\%$ F.S. linearity deviation when used on iron and stainless steel. Furthermore, characteristics for other materials are already programmed in the controller, making selection easy. Of course, the settings can also be customized.

■ Serial interface

The controller can be connected with a personal computer via an RS-232 interface. GP-XAiME, the software included, simplifies data visualization and analysis. Moreover, several systems can be combined and then easily configured at the same time.

- The 5-digit, dual, 2-color digital display offers great visibility

If the measurement results fall within the setting range (GO), they will appear on the lower digital display in green. If they are out of setting range (HI, LO), they will be displayed in the upper digital display in orange. The display position and color change permit accurate visibility even for momentary changes.

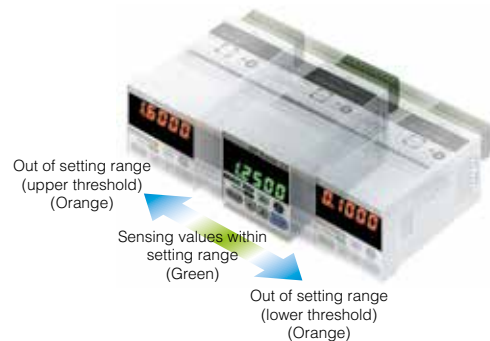

Typical applications

Stroke end sensing



Eccentricity sensing



Height sensing



Technical specifications

Type		Cylindrical heads			Heads with thread		
Model no.	NPN output	GP-XC3SE (note 2)	GP-XC5SE	GP-XC8S	GP-XC10M	GP-XC12ML	GP-XC22KL
	PNP output	GP-XC3SEP	GP-XC5SEP	GP-XC8SP	GP-XC10MP	GP-XC12MLP	GP-XC22KLP
Sensing range		0 to 0.8mm	0 to 1mm	0 to 2mm	0 to 2mm	0 to 5mm	0 to 10mm
Standard sensing object		Stainless steel (SUS304) / Iron sheet, cold rolled carbon steel (SPCC) 60x60x1mm					
Power supply		24VDC ±10%					
Analog voltage output		-5V to +5V (note 1)					
Sampling rate		40kHz (25µs)					
Resolution		GP-XC3SE / GP-XC5SE: 0.04% F.S. (64 times average processing) GP-XC8S / GP-XC10M / GP-XC12ML / GP-XC22KL: 0.02% F.S. (64 times average processing)					
Output		3x NPN or PNP open-collector transistor, max. 100mA					
Protection		Sensor head: IP67 (IEC)					
Ambient temperature		Sensor head: -10 to +55°C, Controller: 0 to +50°C					
Material		Sensor head: stainless steel (SUS303), GP-XC12ML□, GP-XC22KL□: brass (nickel plated), Switch part: PC					
Connection method		Terminal block					
Dimensions	Sensor head (ØxD)	3.8x17mm	5.4x17mm	8x17mm	M10x17mm	M12x21mm	M12x35mm
	Controller (HxWxD)	48x48x83mm					
Accessories		Controller mounting frame, 1 pc.					

Notes:

- 1.) Factory setting: 0 to +5V
- 2.) Model no. for one set (sensor head and controller)

IO-Link
SensorsPhotoelectric
SensorsFiber-optic
Sensors

Standard Fibers

Fiber Sensors
Communication
Units

Mark Sensors

Laser Sensors

Safety Sensors

Pressure &
Flow SensorsInductive
Proximity
SensorsMeasurement
SensorsIonizers/
Electrostatic
Sensors

Accessories

GP-X

IO-Link
SensorsPhotoelectric
SensorsFiber-optic
Sensors

Standard Fibers

Fiber Sensors
Communication
Units

Mark Sensors

Laser Sensors

Safety Sensors

Pressure &
Flow SensorsInductive
Proximity
SensorsMeasurement
SensorsIonizers/
Electrostatic
Sensors

Accessories

ER-Q



ER-Q

Miniature ionizer with fan

Features

■ Small dimensions

Simple and space-saving installation on production lines and manual workstations.

■ Adjustable

A continuously variable adjuster ensures the production of the required air volume.

■ Unit for demanding industrial environments

The LED displays the required maintenance steps or failures; this also can be queried via the outputs of a PLC. Parts for maintenance are easy to get at and replace.



Technical specifications

Type	Standard type
Model no.	ER-Q
Charge removal time ($\pm 1000 \rightarrow \pm 100V$)	Approx. 1.5s
Discharge output voltage	$\pm 2kV$
Ion balance	Max. $\pm 10V$
Discharge method	High frequency AC method
Power supply	24V DC $\pm 10\%$
Power consumption	Max. 200mA
Fan rotation speed	Continuously variable adjustable (potentiometer)
Outputs	ERROR and CHECK NPN open-collector transistor, max. 50mA
Status indicator / Monitoring function	Ready/Discharging (DSC/green), Discharge error (red), Fan error (blinking red)
Ambient temperature	0 to $+50^{\circ}C$
Ambient humidity	35 to 65%RH
Material	Enclosure: PBT, Discharge electrode needles: tungsten
Dimensions (HxWxD)	60x33x65mm
Accessories	I/O connector set manufactured by MOLEX, Inc.: Housing 5557-08P, terminal 5556T



ER-F

Features

Two types

Low volume fan type. This type generates only the half of the air volume as the standard type, which is required for small components and thin film. Four different speeds can be selected for the fan.

Easy maintenance

Because the discharge electrode needle unit is attached to the louver, exchange or maintenance of the electrode needles is made easy without touching the main unit. A safe design: once the louver is removed, the high-voltage circuit is broken and the fan halts. Simply replace the louver to change configuration between long distance and wide area ionization. The two louvers come with the ionizer main body.

Standard fan type
ER-F12

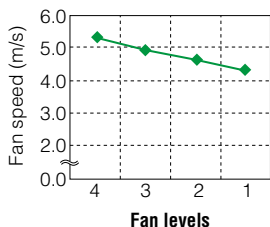

Low-volume fan type
ER-F12S

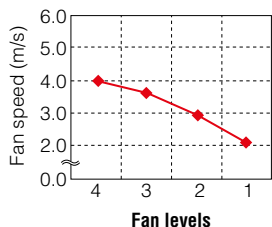

Straight louver removes charges at
great distances



Neutralizes static charges quickly from a great distance

Angled louver removes charges
over wide area



Neutralizes static charges; wide area ionizer



- IO-Link Sensors
- Photoelectric Sensors
- Fiber-optic Sensors
- Standard Fibers
- Fiber Sensors Communication Units
- Mark Sensors
- Laser Sensors
- Safety Sensors
- Pressure & Flow Sensors
- Inductive Proximity Sensors
- Measurement Sensors
- Ionizers / Electrostatic Sensors
- Accessories

Technical specifications

Type	Standard	Low-volume fan
Model no.	ER-F12A	ER-F12SA
Discharge time ($\pm 1000 \rightarrow \pm 100V$)	Approx. 1s	Approx. 1.5s
Discharge output voltage	$\pm 2kV$	
Ion balance	Max. $\pm 10V$	
Discharge method	High-frequency AC	
Power supply	24V DC $\pm 10\%$	
Power consumption	Max. 700mA	Max. 400mA
Fan rotation speed	Adjustable at 4 levels	
Output	ERROR, NPN open-collector transistor, max. 50mA	
Input terminal	Discharge stop = connected to 0V / Start = open	
Status indicators / Monitoring functions	Power supply (Power / green), Discharging (DSC / green), Discharge error (DSC red), Fan error (FAN red)	
Ambient temperature	0 to $+50^{\circ}C$	
Ambient humidity	35 to 65%RH	
Material	Enclosure / Louver: ABS, Fitting of discharge electrode needles: PBT, Discharge electrode needles: tungsten, Mounting bracket: DC03	
Dimensions (HxWxD)	166x161x60mm	
Accessories	Straight louver (note): 1 pc. Angle louver: 1 pc.; Caution label: 1 set; Rubber cushion: 1 pc.	

Note: The discharge electrode needle set is mounted at the louver

IO-Link
SensorsPhotoelectric
SensorsFiber-optic
Sensors

Standard Fibers

Fiber Sensors
Communication
Units

Mark Sensors

Laser Sensors

Safety Sensors

Pressure &
Flow SensorsInductive
Proximity
SensorsMeasurement
SensorsIonizers/
Electrostatic
Sensors

Accessories

ER-F



ER-X

Area ionizer for fast applications

Features

■ Quick charge removal

Thanks to the pulse AC method, the **ER-X** series is well suited for high-speed applications as found in the packaging and semiconductor industries, where charge removal time is directly linked to productivity. In addition, discharge frequencies can be adjusted from between 1 and 100Hz, maximizing flexibility. Thanks to a built-in feedback system, the ionizer can even adjust the discharge frequency automatically during operation.

■ Feedback system

Individual displays for discharge, error messages and electrode needle control are provided on the controller. Furthermore, you can activate settings for frequency, ion balance or limits directly via a potentiometer and DIP switches.



■ Airless operation

The area ionizer of the ER-X series ionizers can be operated with or without air pressure. This technology opens up applications in fields such as the coating industry, as well as the production and packaging of microelectronic components that otherwise are blown around by whirling air.

■ Flexible system configuration

The system consists of a sensor head and a controller. The sensor head is available in different sizes. You can connect parallel up to 2 heads to the controller. This enlarges the working area of the system up to 1.2m.

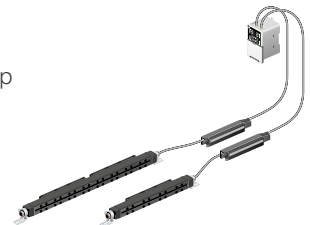

Typical applications

Neutralization of foils



Charge removal from ICs



Charge removal from miniaturized electronic components



IO-Link
Sensors

Photoelectric
Sensors

Fiber-optic
Sensors

Standard Fibers

Fiber Sensors
Communication
Units

Mark Sensors

Laser Sensors

Safety Sensors

Pressure &
Flow Sensors

Inductive
Proximity
Sensors

Measurement
Sensors

Ionizers/
Electrostatic
Sensors

Accessories

ER-X

Technical specifications

IO-Link
SensorsPhotoelectric
SensorsFiber-optic
Sensors

Standard Fibers

Fiber Sensors
Communication
Units

Mark Sensors

Laser Sensors

Safety Sensors

Pressure &
Flow SensorsInductive
Proximity
SensorsMeasurement
SensorsIonizers/
Electrostatic
Sensors

Accessories

Sensor heads

Model no.	Spot	Area				
	ER-X001	ER-X008	ER-X016	ER-X032	ER-X048	ER-X064
Effective charge removal width	Spot type	80mm	160mm	320mm	480mm	640mm
Charge removal time ($\pm 1000 \rightarrow \pm 100V$)	Max. 0.5s	Approx. 1s				
Discharge output voltage	$\pm 7kV$					
Ion balance	Max. $\pm 30V$					
Discharge method	Pulse AC method					
Maximum air pressure	5bar (0.5MPa)					
Ambient temperature	0 to $+50^{\circ}C$					
Ambient humidity	35 to 65%RH					
Material	Enclosure: PPS, Stainless steel; Mounting bracket, Stainless steel; Electrode needle: tungsten					

Controller

Model no.	ER-XC02
Power supply	24V DC $\pm 10\%$
Power consumption	1 head: max. 450mA; 2 heads: max. 800mA
Outputs	Alarm, Error; PhotoMOS, max. 50mA
Status display / Monitor functions of discharge unit	Discharge (DSC)
Ambient temperature	0 to $+50^{\circ}C$
Ambient humidity	35 to 65%RH
Material	ABS
Dimensions (HxWxD)	90x53x64mm
Accessories	MOLEX-plug (Housing 5557-10R, Terminal 5556TL) 1 pc., Ground wire 1pc.

Sensor head connector cables

Model no.	ER-XCCJ2H	ER-XCCJ5H	ER-XCCJ10H
Image			
Length	2m	5m	10m

Note: Cable is not included in delivery. Please order separately



ER-VW

Nozzle angle adjustment

Features

■ Nozzle angle adjustment

The angles of the two nozzles can be adjusted within a range of approximately 190° by screwing down the ends of the nozzles.

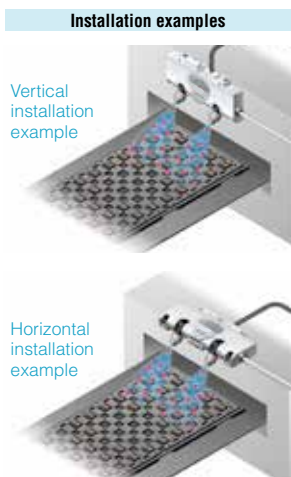

■ Compact and ultrathin design

The thickness of the unit is 18.9mm. Since the nozzle angles can be adjusted, they can be installed in tight spaces, such as when other equipment is present.



Includes angle adjustment scale

■ Minimum air consumption 15ℓ/min.

The ER-VW series can utilize air flow levels starting from a minimum of 15 l/min. Because the amount of air consumed is so low, the loads placed on air supply equipment can be reduced.

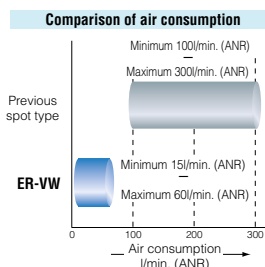

■ Air supply monitoring function

This function causes discharging to stop automatically if the supply of air drops below a certain pressure. Notification of this is given when the AIR indicator lights up and the discharge output (DSC) turns off. This prevents objects which are not charged from being overlooked when the air supply has been stopped.

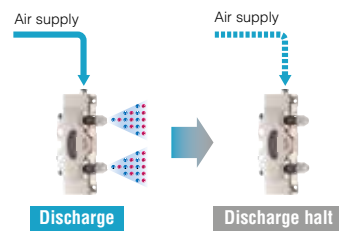

■ Easy connection possible

The joint kit (optional) can be used to connect up to a maximum of 5 ER-VW units. The air supply part is connected via quick connection joints, and the power supply and input/output signals can also be connected easily using connection cables with connectors at both ends.

Multiple ER-VW units can be connected to provide charge removal layouts that suit the target equipment.

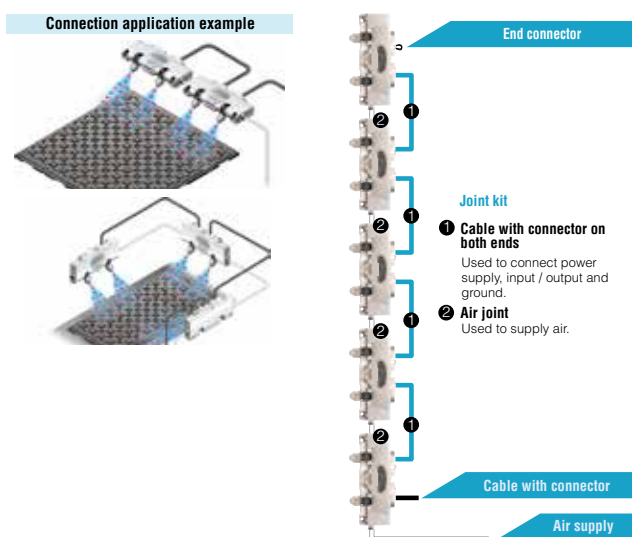

- IO-Link Sensors
- Photoelectric Sensors
- Fiber-optic Sensors
- Standard Fibers
- Fiber Sensors Communication Units
- Mark Sensors
- Laser Sensors
- Safety Sensors
- Pressure & Flow Sensors
- Inductive Proximity Sensors
- Measurement Sensors
- Ionizers / Electrostatic Sensors
- Accessories

ER-VW

■ Functions to support accurate charge removal

In addition to the air supply monitoring function, the ER-VW is equipped with the following functions to ensure accurate charge removal.

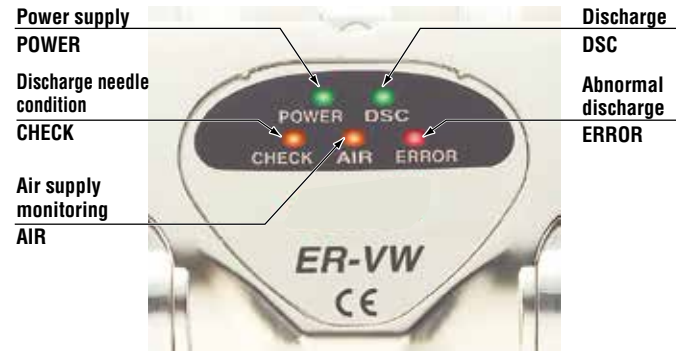

Typical applications

Charge removal of ICs

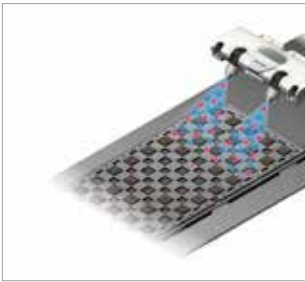

Removing charge during pickup from dicing type

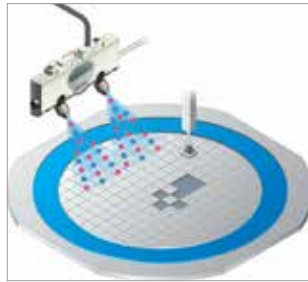

Parallel discharging on two assembly lines

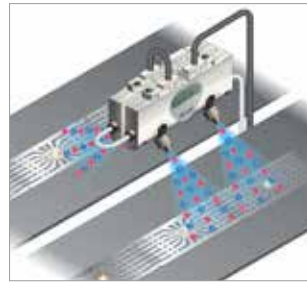

Removing charges from LCD transport brackets

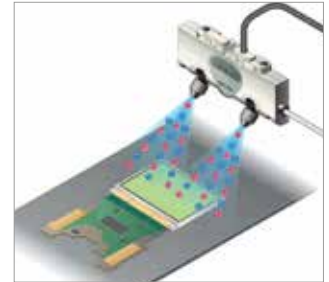

Technical specifications

Type	Spot
Model no.	ER-VW
Charge removal time ($\pm 1000 \rightarrow \pm 100V$)	Max. 1s
Discharge output voltage	$\pm 2kV$
Ion balance	Max. $\pm 10V$
Discharge method	High frequency AC method
Power supply	24VDC $\pm 10\%$
Power consumption	Max. 120mA
Air pressure	0.5 to 5bar (0.05 to 0.50MPa)
Inputs	Reset and discharge stop = connected to 0V / Start= open
Outputs	Discharging (DSC), ERROR and CHECK; NPN open collector transistor; max. 50mA
Status indicators / Monitoring functions	Supply voltage (Power / green), Discharging (DSC / green), Checking electrode needles (Check / orange), Monitoring air pressure (Air / orange), Failure (Error / red)
Ambient temperature	0 to $+55^{\circ}C$
Ambient humidity	35 to 65%RH
Material	Enclosure: ABS (nickel plated), nozzles / nozzle mount, Screws: stainless steel, Discharge electrode needles: tungsten
Dimensions (HxWxD)	19x133x65mm
Accessories	Connector cable with 8 pins, 0.5m, Terminating plug with 9 pins, Ground wire

- IO-Link Sensors
- Photoelectric Sensors
- Fiber-optic Sensors
- Standard Fibers
- Fiber Sensors Communication Units
- Mark Sensors
- Laser Sensors
- Safety Sensors
- Pressure & Flow Sensors
- Inductive Proximity Sensors
- Measurement Sensors
- Ionizers / Electrostatic Sensors
- Accessories
- ER-VW**



ER-V

Ultra compact high-performance ionizer

Features

■ Produces excellent ion balance

The adoption of high-frequency AC method allows extremely stable ion balance to be achieved. Because the ion balance is not affected by the pressure of air supplied or by the setup distance, no troublesome adjustments are required after setup.

■ High performance but no controller needed

A full range of functions have been provided with full consideration given to ease of use in the workplace. No separate controller is needed.

■ Nozzle variations can be selected to suit the application

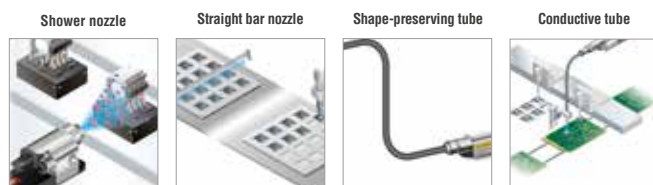

■ Ultra compact design accurately removes charges of objects even from narrow spaces

The main unit is merely 28x27x111.6mm so it can easily be combined with other devices and also be installed as an add-on. Furthermore, the high-voltage power supply is built-in so no extra space is required except for the ionizer itself.



It can be installed in places where the conventional bar type cannot so it can be placed closer to the object for more accurate charge removal.

Typical applications

Change removal and dust removal of lenses



Prevent discharge damage in circuit board LEDs

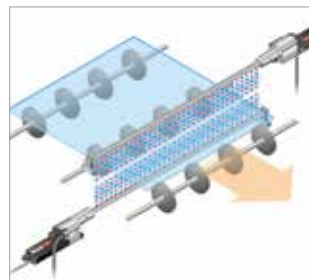

Charge removal glass surfaces

IO-Link
SensorsPhotoelectric
SensorsFiber-optic
Sensors

Standard Fibers

Fiber Sensors
Communication
Units

Mark Sensors

Laser Sensors

Safety Sensors

Pressure &
Flow SensorsInductive
Proximity
SensorsMeasurement
SensorsIonizers/
Electrostatic
Sensors

Accessories







ER-V

Technical specifications

- IO-Link Sensors
- Photoelectric Sensors
- Fiber-optic Sensors
- Standard Fibers
- Fiber Sensors Communication Units
- Mark Sensors
- Laser Sensors
- Safety Sensors
- Pressure & Flow Sensors
- Inductive Proximity Sensors
- Measurement Sensors
- Ionizers/ Electrostatic Sensors
- Accessories
- ER-V

Type	Spot
Model no.	ER-VS02
Charge removal time (±1000 → ±100V)	Max. 1s
Discharge output voltage	±2kV
Ion balance	Max. ±10V
Discharge method	High frequency AC method
Power supply	24V DC ±10%
Power consumption	Max. 70mA
Maximum air pressure	0.5 to 7bar (0,05 to 0.7MPa)
Inputs	Reset and discharge stop = connected to 0V / Start= open
Outputs	Error (ERROR) and check (CHECK) NPN open-collector transistor, max. 50mA
Status indicators / Monitoring functions	Supply voltage (Power / green), Discharging (DSC / green), Checking electrode needles (Check / orange), Error (Error / red)
Ambient temperature	0 to +55°C
Ambient humidity	35 to 65%RH
Material	Enclosure: PPS, Cover: stainless steel, Discharge electrode needles: tungsten
Dimensions (HxWxD)	28x27x111.6mm
Accessories	I/O connector set manufactured by MOLEX, Inc.: Housing 5557-08P, terminal 5556TL

Nozzles

Type	Shower nozzle	Straight bar nozzle			Shape-preserving tube				Conductive tube		
		ER-VAS	ER-VAB020	ER-VAB032	ER-VAB065	ER-VAJK	ER-VAK10	ER-VAK30	ER-VAK50	ER-VAJT-64	ER-AT50
Image											
Length	Shower nozzle	Effective charge removal length 200mm	Effective charge removal length 320mm	Effective charge removal length 650mm	Tube nozzle adapter for main system and shape-preserving tube	Tube length 112mm	Tube length 312mm	Tube length 512mm	Tube nozzle adapter for main system and conductive tube	Tube length 500mm	
Description		Straight bar nozzle containing a series of holes				Bends easily and holds its bent shape so the tube does not need to be secured. (Minimum bending radius: 40mm)	Flexible, free-cut (Minimum bending radius: 15mm)				

Note: Nozzles are not supplied with the ionizer main unit. Please order them separately.

Cable with connector

Model no.	ER-VCCJ2	ER-VCCJ5	ER-VCCJ9
Image			
Length	2m	5m	9m
Net weight	approx. 52g	approx. 120g	approx. 240g
Description	0.15mm ² 8-core cable with connector Cable outer diameter: Ø4.2mm		

Note: The cable with connector is not supplied with the ionizer main unit. Please order it separately.



EC-G

Pulse air-gun ionizer

Features

■ Direct ionized air emission from air gun

With the new pulse air-gun ionizer operators can comfortably neutralize static electricity while manually cleaning.

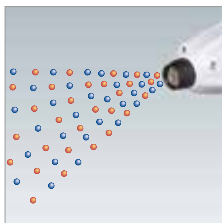

■ Pulsed ionized air

Instant pulse air emission with high air pressure removes dust all at once. Its lightweight construction, ergonomic design and 2m cable make the air gun the perfect ionizer for manual jobs.



■ White LED illumination

A convenient white LED on the front of the gun illuminates target objects.



Technical specifications

Type	Air gun type
Model no.	EC-G02
Charge removal time ($\pm 1000 \rightarrow \pm 100V$)	Average 0.5s
Discharge output voltage	$\pm 1kV$
Ion balance	Max. $\pm 10V$
Discharge method	High frequency AC method
Power supply	Input voltage: 100 to 240V AC, output voltage: 24V DC $\pm 10\%$
Power consumption	Max. 30VA
Maximum air pressure	0.5 to 5bar (0.05 to 0.50MPa)
Input terminal	Charge removal start = connected to 0V
Modes	Pulse 1 (long) and Pulse 2 (short) / CONT (continuous) selectable by switch
LED illumination mode	White LED
Status indicator / Monitoring function	Valve illumination (orange)
Ambient temperature	0 to $+50^{\circ}C$
Ambient humidity	35 to 65% RH (no condensation allowed)
Material	Enclosure: ABS, Nozzle: Stainless steel, Nozzle guard: NBR, Discharge electrode needle: tungsten
Weight	approx. 270g
Accessories	AC adapter, 1 pc.; Exclusive intermediate cable, 2m; Straight joints to couple air tubes $\varnothing 8-8mm$ (note) and $\varnothing 8-6mm$ type, Connector connection terminal from MOLEX

Note: Straight joint to couple air tubes, $\varnothing 8mm$, is attached at shipment

Typical applications

Remove charge and dust on PCB



Remove charge and dust on flat screens



Remove dust before painting

IO-Link
SensorsPhotoelectric
SensorsFiber-optic
Sensors

Standard Fibers

Fiber Sensors
Communication
Units

Mark Sensors

Laser Sensors

Safety Sensors

Pressure &
Flow SensorsInductive
Proximity
SensorsMeasurement
SensorsIonizers/
Electrostatic
Sensors

Accessories

EC-G

IO-Link
SensorsPhotoelectric
SensorsFiber-optic
Sensors

Standard Fibers

Fiber Sensors
Communication
Units

Mark Sensors

Laser Sensors

Safety Sensors

Pressure &
Flow SensorsInductive
Proximity
SensorsMeasurement
SensorsIonizers/
Electrostatic
Sensors

Accessories

EF-S1



EF-S1

Constant monitoring of static charges on production lines

Features

■ Maintains and regulates product quality by preventing damage from static electric

Static electricity that can build up in various places along a process line can be monitored constantly so that abnormalities can be prevented before they occur, ensuring quality.

■ Reduces time for ionizer inspections

The de-ionizing effectiveness of ionizers can be understood in real-time so that things such as ionizer damage and the replacement period for worn components can be checked objectively, reducing the time required for inspection and testing.

Technical specifications

■ Sensor head

Type	Spot type
Model no.	EF-S1HS
Measuring range	8.0 to 20.5mm (± 1 kV) 21.0 to 100mm (± 2 kV)

■ Controller

Type	Spot type
Model no.	EF-S1C
Power supply	24VDC $\pm 10\%$
Display range (Measurement range)	-1000 to 1000 (± 1 kV) -1999 to 1999 (± 2 kV)
Judgment output	NPN open-collector transistor, max. 100mA
Analog voltage output	Output voltage 1 to 5V Load impedance approx. 100 Ω

Typical applications

Measuring surface potential when removing BG sheets

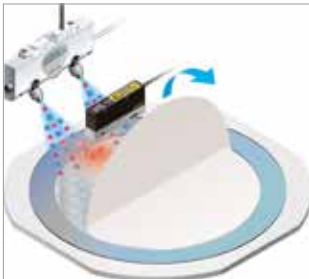

Measuring static electric charge in lead frames

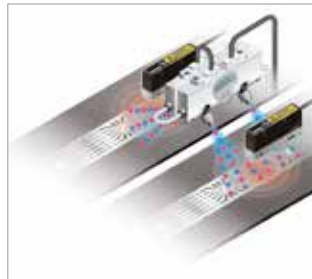

Measuring frictional electrification of LCD modules

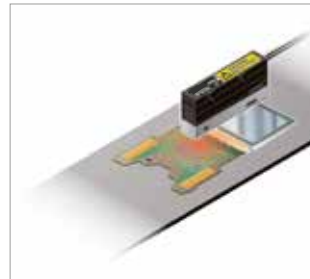











Cables

Picture	Description	Model no.	Applicable sensors
	4-pin M8 connector cable, 2m	UZZ80820D	CX-4□□Z, FX101□□Z, FX102□□Z, DP11□□EPJ
	4-pin M8 connector cable (elbow type 90°), 2m	UZZ80821D	CX-4□□Z, FX101□□Z, FX102□□Z, DP11□□EPJ
	4-pin M8 connector cable, 5m	UZZ80850D	CX-4□□Z, FX101□□Z, FX102□□Z, DP11□□EPJ
	4-pin M8 connector cable (elbow type 90°), 5m	UZZ80851D	CX-4□□Z, FX101□□Z, FX102□□Z, DP11□□EPJ
	4-pin M12 connector cable, 2m	UZZ81220D	LX-101□□Z, CX-4□□Z, EQ-30, CY-1□□Z, GX-M□□-Z
	4-pin M12 connector cable (elbow type 90°), 2m	UZZ81221D	LX-101□□Z, CX-4□□Z, EQ-30, CY-1□□Z, GX-M□□-Z
	4-pin M12 connector cable, 5m	UZZ81250D	LX-101□□Z, CX-4□□Z, EQ-30, CY-1□□Z, GX-M□□-Z
	4-pin M12 connector cable (elbow type 90°), 5m	UZZ81251D	LX-101□□Z, CX-4□□Z, EQ-30, CY-1□□Z, GX-M□□-Z
	4-wire cable with connector, 2m	CN14AC2	PM-□□65, DP-100, DP-0
	4-wire cable with connector, 5m	CN14AC5	PM-□□65, DP-100, DP-0
	3-wire cable with connector, 1m	CN13C1	PM2
	3-wire cable with connector, 3m	CN13C3	PM2
	3-wire main cable, 2m	CN73C2	FX-301□, FX311, FX-5□□1□, FX-CH2□, SC-GU-1-485
	3-wire main cable, 5m	CN73C5	FX-301□, FX311, FX-5□□1□, FX-CH2□, SC-GU-1-485
	1-wire sub cable, 2m	CN71C2	FX-301□, FX-311, FX-501□
	1-wire sub cable, 5m	CN71C5	FX-301□, FX-311, FX-501□
	4-wire main cable, 2m	CN74C2	FX-305□, FX-502□, LS-401□, LS-501□
	4-wire main cable, 5m	CN74C5	FX-305□, FX-502□, LS-401□, LS-501□
	2-wire sub cable, 2m	CN72C2	FX-305□, FX-502□, LS-401□, LS-501□
	2-wire sub cable, 5m	CN72C5	FX-305□, FX-502□, LS-401□, LS-501□
	14-wire connecting cable, 2m	HL-G1CCJ2	HL-G1□-S-J
	14-wire connecting cable, 5m	HL-G1CCJ5	HL-G1□-S-J
	14-wire cable, 10m	HLG1CCJ10	HL-G1□-S-J
	14-wire cable, 20m	HLG1CCJ20	HL-G1□-S-J
	14-wire cable, 2m	HL-C2CCJ2	HL-C2□
	14-wire cable, 5m	HL-C2CCJ5	HL-C2□
	14-wire cable, 10m	HL-C2CCJ10	HL-C2□
	14-wire cable, 20m	HL-C2CCJ20	HL-C2□
	14-wire cable, 30m	HL-C2CCJ30	HL-C2□

- IO-Link Sensors
- Photoelectric Sensors
- Fiber-optic Sensors
- Standard Fibers
- Fiber Sensors Communication Units
- Mark Sensors
- Laser Sensors
- Safety Sensors
- Pressure & Flow Sensors
- Inductive Proximity Sensors
- Measurement Sensors
- Ionizers / Electrostatic Sensors
- Accessories

Cables

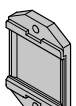
Reflectors

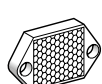
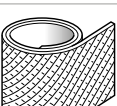
Picture	Description	Model no.	Applicable reflectors
	Reflection foil: 8x30mm, thickness 0.7mm	RF11	CX-400, EX-20, NX5
	Reflection foil: 25x30mm, thickness 0.7mm	RF12	CX-400, EX-20, NX5
	Reflection foil: 30x30mm, thickness 0.5mm	RF13	CX-400
	Reflective area: 9.6x17.5mm	RF200	EX-20
	Reflective area: 12.8x33.3mm	RF210	CX-400, EX-L200, NX5
	Reflective area: 42.3x35.3mm	RF220	CX-400, NX5
	Reflective area: 59.3x50.3mm	RF230	CX-400, LS-H921, NX5
	Reflective area: 7x8mm	RF310	LS
	Reflection foil: 27.8 x25.2mm	RF33	LS
	Reflective area: 23x24mm	RF330	EX-L200, LS-H911, LS-H901
	Reflective area: 24x21mm	RF-420	CY-100
	Reflective area: 50x47mm	RF-410	CY-100
	Adhesive reflection tape: 22mm x 5m, thickness 0.4mm	RF-40RL5	CY-100

IO-Link
SensorsPhotoelectric
SensorsFiber-optic
Sensors

Standard Fibers

Fiber Sensors
Communication
Units

Mark Sensors

Laser Sensors









Safety Sensors

Pressure &
Flow SensorsInductive
Proximity
SensorsMeasurement
SensorsIonizers/
Electrostatic
Sensors

Accessories

Reflectors

■ Mounting brackets

Picture	Description	Model no.	Applicable reflectors
	L-shaped mounting bracket	MS-EXL2-1	EX-L200, LS-H102
	Mounting plate	MSLX1	LX-100
	Mounting bracket	MSCX1	CX-400, LS-400
	Mounting bracket	MSCX21	CX-400
	Mounting bracket	MSNX51	NX5
	Mounting bracket	MS-EXZ-2	EX-Z Top sensing
	Mounting bracket	MS-EXZ-2	EX-Z Side sensing
	Mounting bracket	MSEX101	EX-10
	Mounting bracket	MSEX201	EX-20 Top sensing
	Mounting bracket	MSEX202	EX-20 Side sensing
	Mounting set, 4 mounting brackets M4(l=15mm) 4pcs., M4 (l=18mm) 8pcs.	MSNA11	NA1-11
	Mounting bracket	MSEQ501	EQ-500
	Mounting bracket	MSEQ31	EQ-30
	Mounting bracket	MSDIN4	FX-100
	Mounting bracket	MSDIN2	FX-300, FX-500
	Mounting bracket	MS-FM2-1	FM-200
	Mounting bracket	MSDP11	DP-100, DP-0
	Mounting bracket	MS-DP1-6	DPC-100, DPC-L100
	Mounting bracket, stainless steel	MS-CY1-1	CY-100
	Mounting bracket for beam axis alignment, plastic	MS-CY1-2	CY-100

IO-Link
SensorsPhotoelectric
SensorsFiber-optic
Sensors

Standard Fibers

Fiber Sensors
Communication
Units

Mark Sensors

Laser Sensors

Safety Sensors

Pressure &
Flow SensorsInductive
Proximity
SensorsMeasurement
SensorsIonizers/
Electrostatic
Sensors

Accessories

Mounting
brackets



North America

Europe

Asia Pacific

China

Japan

Panasonic Electric Works

Please contact our Global Sales Companies in:

Europe		
▶ Headquarters	Panasonic Electric Works Europe AG	Caroline-Herschel-Strasse 100, 85521 Ottobrunn, Tel. +49 89 45354-1000, Fax +49 89 45354-1550, www.panasonic-electric-works.com
▶ Austria	Panasonic Industry Austria GmbH	Josef Madersperger Str. 2, 2362 Biedermannsdorf, Tel. +43 (0) 2236-26846, Fax +43 (0) 2236-46133 www.panasonic-electric-works.at
	Panasonic Industrial Devices Materials Europe GmbH	Ennshafenstraße 30, 4470 Enns, Tel. +43 (0) 7223 883, Fax +43 (0) 7223 88333, www.panasonic-electronic-materials.com
▶ Benelux	Panasonic Electric Works Sales Western Europe B.V.	De Rijn 4, 5684 PJ Best, Netherlands, Tel. +31 (0) 499 372727, www.panasonic-electric-works.nl
▶ Czech Republic	Panasonic Electric Works Europe AG, organizační složka	Administrative centre PLATINIUM, Veveří 3163/111, 616 00 Brno, Tel. +420 541 217 001, Fax +420 541 217 101, www.panasonic-electric-works.cz
▶ France	Panasonic Electric Works Sales Western Europe B.V.	Succursale française, 10, rue des petits ruisseaux, 91370 Verrières Le Buisson, Tél. +33 (0) 1 6013 5757, Fax +33 (0) 1 6013 5758, www.panasonic-electric-works.fr
▶ Germany	Panasonic Electric Works Europe AG	Caroline-Herschel-Strasse 100, 85521 Ottobrunn, Tel. +49 89 45354-1000, Fax +49 89 45354-2111, www.panasonic-electric-works.de
▶ Hungary	Panasonic Electric Works Europe AG	Magyarországi Fióktelepe, 1117 Budapest, Aliz utca 4, Tel. +43 (0) 2236 26846 -25, Fax +43 (0) 2236 46133 www.panasonic-electric-works.hu
▶ Ireland	Panasonic Electric Works UK Ltd.	Irish Branch Office, Dublin, Tel. +353 (0) 14600969, Fax +353 (0) 14601131, www.panasonic-electric-works.co.uk
▶ Italy	Panasonic Industry Italia srl	Via del Commercio 3-5 (Z.I. Ferlina), 37012 Bussolengo (VR), Tel. +39 0456752711, Fax +39 0456700444, www.panasonic-electric-works.it
▶ Nordic Countries	Panasonic Electric Works Europe AG	Filial Nordic, Knarrarnäsgatan 15, 164 40 Kista, Sweden, Tel. +46 859476680, Fax +46 859476690, www.panasonic-electric-works.se
	Panasonic Fire & Security Europe AB	Jungmansgatan 12, 21119 Malmö, Tel. +46 40 697 7000, Fax +46 40 697 7099, www.panasonic-fire-security.com
▶ Poland	Panasonic Industry Poland sp. z o.o.	Ul. Dowborczyków 25, 90-019 Łódź, Polska, Tel. +48 42 2309633, www.panasonic-electric-works.pl
▶ Spain	Panasonic Industry Iberia S.A.	Barajas Park, San Severo 20, 28042 Madrid, Tel. +34 913293875, Fax +34 913292976, www.panasonic-electric-works.es
▶ Switzerland	Panasonic Industry Switzerland AG	Grundstrasse 8, 6343 Rotkreuz, Tel. +41 (0) 41 7997050, Fax +41 (0) 41 7997055, www.panasonic-electric-works.ch
▶ United Kingdom	Panasonic Electric Works UK Ltd.	Sunrise Parkway, Linford Wood, Milton Keynes, MK14 6 LF, Tel. +44 (0) 1908 231555, Fax +44 (0) 1908 231599, www.panasonic-electric-works.co.uk
North & South America		
▶ USA	Panasonic Industrial Devices Sales Company of America	Two Riverfront Plaza, 7th Floor, Newark, NJ 07102-5490, Tel. 1-8003-442-112, www.pewa.panasonic.com
Asia Pacific / China / Japan		
▶ China	Panasonic Electric Works Sales (China) Co. Ltd.	Tower C 3rd Floor, Office Park, NO.5 Jinghua South Street, Chaoyang District, Beijing 100020, Tel. +86-10-5925-5988, Fax +86-10-5925-5980
▶ Hong Kong	Panasonic Industrial Devices Sales (HK) Co., Ltd.	Suite 301, 3/F, Chinachem Golden Plaza, 77 Mody Road, TST East, Kowloon, Hong Kong, Tel. +852-2529-3956, Fax +852-2528-6991
▶ Japan	Panasonic Corporation	1006, Oaza Kadoma, Kadoma-shi, Osaka 571-8501, Japan, Tel. +81-6-6908-1121, www.panasonic.net
▶ Singapore	Panasonic Industrial Devices Automation Controls Sales Asia Pacific	No.3 Bedok South Road, Singapore 469269, Tel. +65-6299-9181, Fax +65-6390-3953