



BERGAMO - ITALY

100 years

1922
2022

GENERAL
CATALOGUE
2021 / 2022



electric

ENERGY AND AUTOMATION



01
Motor protection circuit breakers



02
Contactors



03
Motor protection relays



04
Electromechanical starters and enclosures



05
Soft starters



06
Variable speed drives



07
Pushbuttons and selector switches



08
Signal towers and beacons



09
Limit, micro and foot switches



10
Safety modules
new



11
Rotary cam switches



12
Switch disconnectors



13
Fuse holders and fuses



14
Miniature and residual circuit breakers



15
Surge protection devices



16
Modular contactors and other modular devices



17
Earth leakage relays



18
Time relays



19
Monitoring relays



20
Level controls



21
General purpose relays



22
Micro PLCs and HMI



23
Switching power supplies



24
Automatic battery chargers



25
Metering instruments and CTs



26
Power factor controllers and thyristor modules



27
Automatic transfer switch controllers



28
Engine and generator controllers



29
Fire pump controllers



30
Software and applications



31
Expansion modules and accessories

NEW PRODUCTS 2021/2022

UL CERTIFICATION FOR TYPE F STARTERS

Our entire range of SM...R motor protection circuit breakers (from 0.1 to 100A) has obtained Type F UL certification for combined installation with contactors. The combination of motor protection breaker and contactor, tested for its coordination in short circuit, covers the main functions demanded of a starter, i.e. short circuit protection, overload protection and motor control.

PAGE 1-4



160 TO 230A CONTACTORS IN AC3 BF SERIES

These are very compact units: 105mm wide for the three-pole versions and 140mm for the four-pole versions; motor current at 400V from 160 to 230A and Ith thermal current from 250 to 350A. The control coil operates in both AC and DC with electronic control and a wide supply voltage range. The AC/DC coil also features low power consumption, only closes at the correct supply voltage, and has a built-in noise filter. A wide range of accessories is available, including front- and side-mounting auxiliary contacts, mechanical interlocks, power terminal protection and a connection kit for configuration as star-delta starters or remote switches.

PAGE 2-4



CONNECTIONS FOR STARTER AND CHANGEOVER CONTACTOR

LOVATO Electric's range of connections for starter and changeover contactor has been greatly expanded. These accessories offer fast cabling, prevent errors, and make the starters both compact and attractive. They are made as a single unit, with the live components completely isolated.

Kits are available for reversing contactors, star-delta starters and changeover contactors in both 3- and 4-pole versions.

The reversing contactor connections are available for contactors up to 230A AC-3 400V, the star-delta connections enable configuring motor starters up to 400A AC-3 400V, while changeover connections are available for contactors up to 350A in category AC-1.

PAGE 2-23

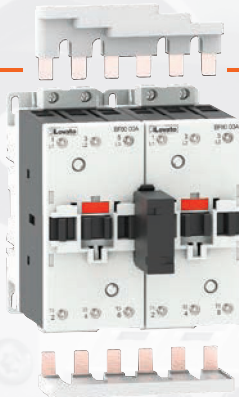

REVERSING AND CHANGEOVER CONTACTORS ASSEMBLIES

Ready for use, these units are ideal for quickly configuring power grid switching panels for nominal currents from 32A to 165A in category AC-1.

They are equipped with a mechanical interlock with 2 NC contacts which implement the electrical interlock.

PAGE 4-5

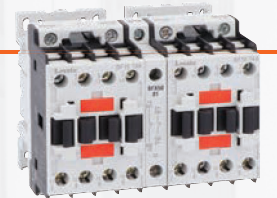

SOFT STARTERS ADXN SERIES

Simple and quick to configure, these units are equipped with an extended power range, from 208 to 600VAC, control two phases and feature an integrated bypass relay.

Their extremely compact footprint (45mm wide) makes them ideal for installation in restricted spaces. They have many applications, including pump, compressor, fan, mixer and belt conveyor control.

The range covers nominal currents from 6 to 45A, and includes 3 variants: a basic version with potentiometer regulation, a programmable version featuring NFC technology and an advanced version with both potentiometers and NFC plus integrated current thermal protection. The advanced version can also be equipped with an optional RS485 communications port module.

PAGE 5-2



SINGLE-PHASE VARIABLE SPEED DRIVES VT1 SERIES

These new units round out our range of variable speed drives with single-phase 200 to 240VAC power rated 0.2 to 2.2kW, a compact footprint and integrated RS485 port.

Simple and versatile, VT1 drives can be used for many applications including control of pumps, fans, air conditioning systems, belt conveyors and packaging machinery, to name just a few. Their compact footprint makes them ideal for installation in enclosures with limited space. Their integrated RS485 ports enable them to be controlled remotely and monitored by a supervision system.

They are programmable with the front-panel keyboard, or using a PC with the dedicated software and a USB connection.

PAGE 6-4



PLATINUM SERIES Ø22MM METAL PUSH BUTTONS (LPS)



The Platinum series has been expanded with new Ø22mm metal buttons and switches. The system has a very high IP protection rating against the ingress of dust and water: IP66, IP67, IP69K. The operating temperature range reaches as high as +70°C. And the new metal construction is compatible with all plastic Platinum accessories (electrical contacts, lamp holders, caps, label holders, protections, disks, etc.). The range is composed of spring-return and push-push button actuators, spring-return mechanical button actuators, mushroom head button actuators, double- and triple-touch spring-return button actuators, lever, knob and key selector switch actuators, pilot light heads, USB and RJ45 interfaces and lever manipulators.

PAGE 7-2

PLATINUM SERIES FLUSH-MOUNTED Ø30MM METAL PUSH BUTTONS (LPF)

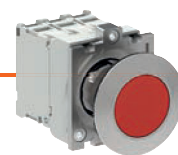

The Platinum series has been expanded with the new Ø30mm flush mounted metal series with protection ratings IP66, IP67 and IP69K. The spring-return button actuators are available in flush (including illuminated) and protruding (including illuminated) versions, and with extended guards. The push-push button actuators are available in flush (including illuminated) and protruding (including illuminated) versions. The selector switch actuators are available in the lever version (including illuminated) as well as key and knob versions. The pilot light heads are available in green, red, yellow, blue and transparent. Finally, both USB and RJ45 communications interfaces are available.

PAGE 7-2

ASSEMBLED BUTTON PANELS



Platinum series assembled button panels are built of a wide range of actuators, plastic housings and contacts. The actuators are pre-assembled to the cover with a threaded collar. The contacts are snap-mounted to the base of the panel to enable quick cabling and reduce labour should they need to be replaced or upgraded. Further to the catalogue models, we also offer custom versions with the client's choice of actuators, panel and contacts.

PAGE 7-53

PALM SWITCHES



LP9 mushroom head buttons, designed for machine stop and immediate control applications, have an ergonomic design with a large surface for easy actuation with the hand, elbow or foot. The button's large area ensures immediate actuation of machinery and equipment even if the operator already has his hands full. The range is divided into two versions: one with a rocker shaft with jog button, and one with an axial shaft and latching button which releases when pulled out.

PAGE 7-59

LTN SERIES Ø50MM AND Ø70MM SIGNAL TOWERS



LTN series signal towers are available in both Ø50mm and Ø70mm versions. Designed for signalling system status with lights and sounds, they can be assembled from up to 5 modules. The lamp modules can emit flashing or steady on signals, and are available in green, yellow, red, blue, amber/orange and white. There are also 2 types of sound module with different sound levels. The cabling modules are available for 3 power voltages: 12V, 24V and 110 - 230V. A variety of mounting options are available, with plastic and metal bases and up to 400mm extension tubes.

PAGE 8-3

NEW PRODUCTS 2021/2022

SAFETY MODULES

The new LOVATO Electric series of safety modules is designed for applications up to Cat. 4 and performance level PLc. Conforming with Machinery Directive EN ISO 13849-1, they are used to monitor and safely control safety circuits in applications with emergency stops, safety gates, magnetic safety switches, safety limit switches, electromechanical interlocks and safety barriers. We also offer a multifunction model which integrates all functions into a single unit, which can be configured with a front-mounted selector.

CHAPTER 10



ROTARY CAM SWITCHES GF SERIES

The new GF series of cam switches is the most compact we offer, and requires very little space for installation and connection: the IP20 rated terminals are mounted on the top and bottom of the switch, so that modules can be mounted side-by-side in a very compact layout. The switches have been developed to satisfy the requirements of manufacturers of small machines in applications up to 20A.

CHAPTER 11



ROTARY CAM SWITCHES 4G SERIES

The 4G series of cam switches is dedicated to high power applications, and is available in 200A to 315A versions. For even heavier duty applications, we offer custom 4G series models rated up to 2000A. Layouts are available up to 12 positions and 12 contact elements (24 contacts).

CHAPTER 11



ROTARY CAM SWITCHES GNA20 TYPE

The GNA20 switch is designed for applications with limited clearance behind the mounting panel and switching layouts with a large number of contacts. The stand out feature of this 20A switches is the option to install up to 4 contacts per contact element, thus offering a maximum configuration of 48 contacts, making it ideally suited for special executions.

CHAPTER 11



SWITCH DISCONNECTORS WITH YELLOW/RED FRONT PLATE GA SERIES

Our GA... series of DIN rail disconnectors now features a new version with yellow/red front plate, typically used for emergency switches. This new type of switch disconnecter is available for currents from 16A to 160A.

PAGE 12-9



63A AND 160A DOOR MOUNTING SWITCH DISCONNECTORS SERIES

The GA... series of switch disconnectors for door mounting has been expanded with the introduction of two new ratings: 63A and 160A lth thermal current. These new sizes are also available with a fourth simultaneous closing pole for four-pole configurations.

PAGE 12-10



ASSEMBLED SWITCH DISCONNECTORS AND CHANGEOVER SWITCHES GA SERIES

The GA series of disconnectors has been expanded with the introduction of the pre-assembled version of the changeover switches. Available in 6 ratings from 25A to 160A, this type is ideal for three-pole (GA...ET6) and four-pole (GA...ET8) applications.

PAGE 12-17



SWITCH DISCONNECTORS GA SERIES: KIT WITH ROD, HANDLE AND TERMINAL COVER

GA series switch disconnectors are now available as a kit including the disconnector itself with terminal covers, a 300mm rod and door lock handle. 3 ratings are available, at 25A, 40A and 63A, in both three- and four-pole versions. The kit handle is the GAX63, with a protruding yellow/red selector, which mounts to a Ø22mm hole with a threaded collar.

PAGE 12-17

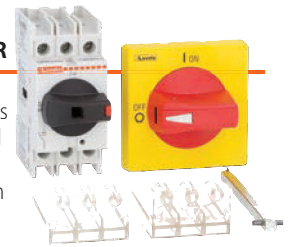

SWITCH DISCONNECTORS AND CHANGEOVER SWITCHES GL SERIES

The GL series of switch disconnectors is now available for applications up to 630A. The power contact command technology now enables use of these devices in category AC23A with a 630A 400V load. UL98 (400A) and UL1008 (400A) type approved versions are also available.

The handles, which feature the highest protection rating on the market (IP66, IP69K and NEMA 4X), make it possible to configure a direct control version, or a door interlock version with the addition of an extension.

The range includes terminal mounts, auxiliary contacts, contact covers, phase separators and nut supports.

PAGE 12-26



CHANGEOVER SWITCH DISCONNECTORS GE SERIES

The GE series of changeover switch disconnectors has been expanded with the three new ratings of 2000A, 2500A and 3150A.

Available in both three- and four-pole versions, these disconnectors enable switching of very high power loads.

PAGE 12-38

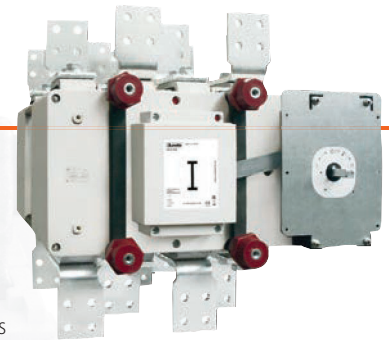

SWITCH DISCONNECTORS FOR PHOTOVOLTAIC APPLICATIONS GD SERIES

The GD series of switch disconnectors for photovoltaic applications has been expanded with the introduction of 3 new codes covering applications up to 25A 1500VDC and 40A 1000VDC.

The 3 new codes have maximum ratings of 25A / 1000VDC, 25A / 1200VDC and 32A / 1000VDC.

PAGE 12-46



FUSE HOLDERS AND FUSES FOR PHOTOVOLTAIC APPLICATIONS UP TO 1500VDC

LOVATO Electric's range of fuse holders has been expanded to cover photovoltaic applications up to 1500VDC.

There is also a new version with a pilot light to indicate when the fuse has tripped. The fuse holders are designed for 35mm DIN rail mounting.

gPV class fuses can be used in applications up to 20A (10x85mm) and 32A (14x85mm).

PAGE 13-4



NEW PRODUCTS 2021/2022

MODULAR SWITCH DISCONNECTORS

These disconnectors have the typical form factor of lever actuated modular switches. They are fully compatible with products mounted in electrical enclosures with modular windows like miniature circuit breakers, residual current operated circuit breakers with overload protection and residual current operated circuit breakers. The new modular disconnectors have current ratings from 32A to 125A and are available in 1, 2, 3 and 4 pole versions. They can also be equipped with auxiliary contacts.

PAGE 14-13



RESIDUAL CURRENT OPERATED CIRCUIT BREAKERS

The introduction of the new P1RD type enable installation of auxiliary contacts and connection of both residual current operated and miniature circuit breakers on a single power bar. They are available up to 63A, in 2 and 4 pole versions with AC or A class tripping, and for residual currents of 30mA and 300mA. A device to padlock the lever is also available.

PAGE 14-14



RESIDUAL CURRENT OPERATED CIRCUIT BREAKERS WITH OVERLOAD PROTECTION

The new P1RE type offers the option of installing auxiliary contacts and features a double actuator lever to differentiate residual current operation from overload protection. They also feature a new isolating barrier on the connection terminals. This means that the protection rating of IP20 covers not just the front of the product but also the connection terminals, which maintain the protection rating whatever cable cross-section is used. They are available up to 40A in the 1P+N version with AC or A class tripping, for residual currents of 30mA and 300mA and a type C thermal trip curve.

PAGE 14-15



TYPE 2 AND TYPE 1, 2 SPD FOR PHOTOVOLTAIC APPLICATIONS

LOVATO Electric's SPD range has been expanded with the introduction of new type 2 SG2DG models for rated voltages of Un 600VDC and SA2EDG for Un 1100VDC respectively, and type 1, 2 SG2EDG for Un 1100VDC.

PAGE 15-7



BELLS AND MODULAR TRANSFORMERS

This range of products is particularly suited to third party service and residential applications. The sound modules have either a classic bell or buzzer sound, with noise level up to 84dB. The transformers are available in versions for intermittent duty, for bells and buzzers, as well as continuous duty versions. They are rated for 15VA to 63VA with output voltages of 12V and 24V. All transformers have integrated overload and short circuit protection (PTC).

PAGE 16-5



ZERO CROSSING STAIRCASE TIME RELAY

These are used in residential and third party service applications for timed stairwell light actuation.

Load switching uses zero crossing technology to reduce the peak load generated when the light is turned on, a very important criterion for LED lamps.

This extends the life of the lamp itself and also protects the time relay's contact against sticking. In addition to the timed light actuation function, the units also feature a stairwell cleaning function with an option to warn the user when the lamp is about to be switched off.

PAGE 18-4



BACKUP POWER SUPPLIES PMVFUPS01

Standards CEI 0-21 and CEI 0-16 which set out the technical regulations for the connection of active and passive users to low and medium voltage utility company power grids provide for an auxiliary power supply system rated to enable, should the main power supply fail, operation of the interface protection system, retentive closure of the interface device and optional retripping for at least 5 seconds. LOVATO Electric offers the PMVFUPS01 backup power supply, designed and tested in combination with only our PMVF interface devices listed in the catalogue.

PAGE 19-13

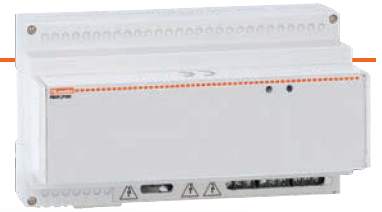

PMVF80 INTERFACE PROTECTION SYSTEM

LOVATO Electric has expanded its PMVF interface protection system range with the addition of the PMVF80, designed for use in cogeneration plant in conformity with the German regulations for the connection of renewable energy generators to power grids (VDE-AR-N 4105 and VDEV 0126-1-1), as applicable in Germany and Switzerland and also accepted in many other countries, including Austria, South Africa, Turkey, Greece, Belgium, France, Denmark, the Czech Republic and Poland, among others.

PAGE 19-15



INDUSTRIAL RELAY HR40 TYPE

The HR40 relay expands the HR series of industrial relays and is specifically designed to enable the user to assess the wear of the contacts, thanks to their frontal positioning and the unit's transparent housing. Furthermore, the absence of a test unit makes it ideal for applications in which manual relay actuation is to be prevented.

It is available in versions with 1 16A changeover contact or 2 10A changeover contacts.

PAGE 21-6



PUSH-IN SPRING LOADED SOCKET FOR INDUSTRIAL RELAY HR SERIES

LOVATO's spring loaded sockets for HR series industrial relays are now even more convenient to use. The use of push-in technology greatly simplifies and speeds up cabling. They have excellent, highly effective cable retention against shock and vibration. Even high levels of traction during cabling and service do not affect their ability to retain the cable. The terminal release button, easy to identify and operate, also makes it very easy to release the cable when needed.

PAGE 21-6



ATEX CERTIFIED INDUSTRIAL RELAY HR80 TYPE

Propane gas is ever more widely used in refrigeration applications due to its high energy efficiency and eco-friendliness. However, this means that the electrical equipment installed in refrigerators containing the gas must be conforming with the ATEX regulations for potentially explosive atmospheres.

HR80 relays are designed specifically for these applications, are rated for a current of 30A and are available for 2 NO contacts or 2 changeover contacts. They are equipped with Faston terminals and suited for screw mounting to the panel.

PAGE 21-8



NEW PRODUCTS 2021/2022

COMPACT POWER SUPPLIES PSE1 SERIES

LOVATO Electric has expanded its offering of switching power supplies with the introduction of the PSE1 series single-phase units: ultra-compact, simple and competitive. Made for DIN rail mounting, they have ultra-compact housings which make them ideal for installation in enclosures with restricted space. They feature a 100...240VAC single-phase input and 24VDC output, and are available for powers from 30W to 120W.

PAGE 23-2



MID AND UL TYPE APPROVED ENERGY METERS WITH EXTENDED TEMPERATURE RANGE UP TO 70°C

Our range of MID type approved single- and three-phase meters has been expanded with direct insertion models with operating temperature extended up to 70°C, ideal for applications in electric vehicle recharging stations, even when installed outdoors, and hence subject to high levels of heating in warm climates.

The following units are available:

- single-phase meter up to 40A in a single module (17.5mm), MID approved
- three-phase meter up to 80A in a just 4 modules (72mm), MID approved
- integrated RS485 communications port
- three-phase meter up to 80A in just 4 modules (72mm), cULus approved, with ANSI C12.20 compliant accuracy (class 0.5).

PAGE 25-13



DMG620 MULTIMETER WITH INTEGRATED ETHERNET PORT

The requirement to monitor plant using energy monitoring software is ever more common in industrial and service applications.

The new DMG620 multimeter is equipped with an Ethernet port to facilitate integration into data networks. Its class 0.5s active energy metering accuracy enables it to satisfy all energy analysis and diagnostics requirements.

PAGE 25-23



A NEW GENERATION OF METERING INSTRUMENTS DMG SERIES

Our DMG series of digital metering instruments has been renewed with new advance models with:

- a larger colour LCD graphic display
- smartphone programming option using NFC technology
- 4 versions are available with the following options:
 - integrated RS485 and Ethernet communications port
 - integrated data memory
 - webservice access to settings and measurements.

PAGE 25-19



MULTI-CIRCUIT METERING SYSTEM

With current metering modules and electronic current transformers, our new DMG series multimeters enable multi-circuit metering in power enclosures in which the voltage metering is concentrated in a single point, and current draw metering points can be configured downline of the individual outputs quickly and easily. The result is a modern energy monitoring system with numerous benefits:

- reduced installation errors
- reduced cabling requirements
- space saving on the front of the enclosure since the data are available on the display and via the communications interface of the DMG multimeter to which the multi-circuit system is connected.

PAGE 25-20

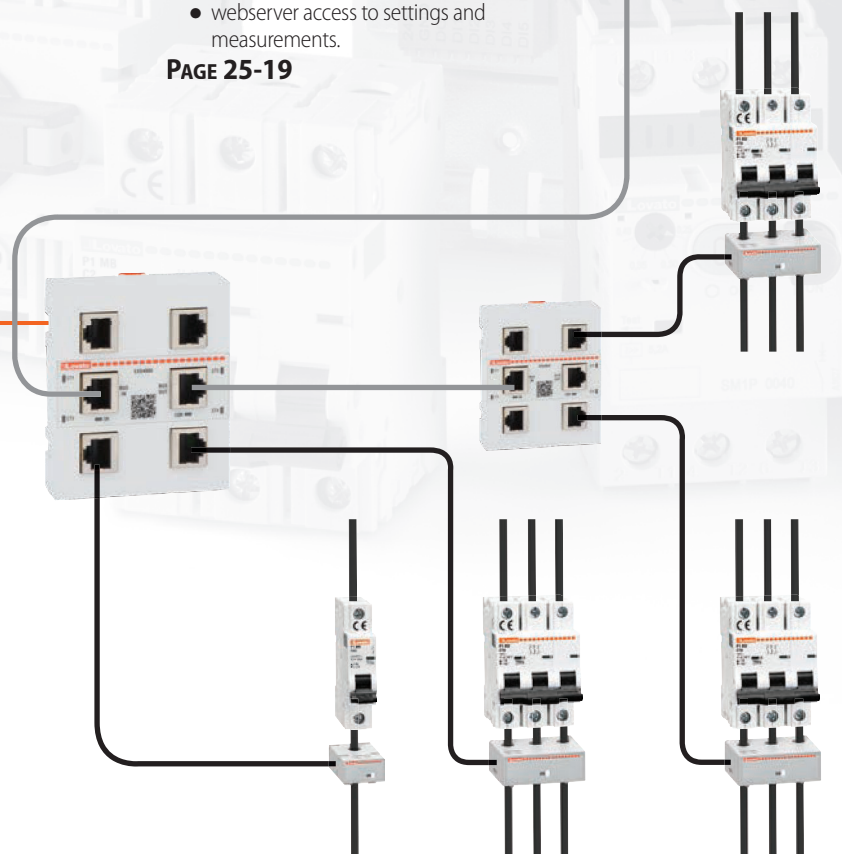

WOUND PRIMARY AND SOLID CORE CTs FOR BARS

LOVATO Electric's wide range of current transformers is further expanded by the introduction of wound primary transformers and the integration of the solid core type. Wound primary technology makes it possible to read even very low currents (to 5A).

The new solid core transformers have a form factor featuring a cavity for mounting to electric bars, thus optimising their use.

PAGE 25-32



AUTOMATIC TRANSFER SWITCH CONTROLLER ATL500

LOVATO Electric's offering of automatic transfer controllers has been expanded with the simple, ready to use ATL500. Dedicated to switching between two lines, it has a front mounted LED synoptic panel for system status display, and features NFC technology for configuration with a smart device (system data, password, I/O functions, etc.). It has two voltage inputs for three-phase + neutral metering, from which it also draws its own power, thus eliminating the need for an auxiliary power supply. It can also be installed in single- and two-phase systems. Its integrated outputs enable it to control contactors and motorised switches.

PAGE 27-2



CONTROLLERS FOR SINGLE-PHASE FIRE PUMPS

Our electric pump controllers are now also available for single-phase motors used in systems lacking three-phase power, such as residential buildings.

CHAPTER 29



Synergy SOFTWARE

Synergy now has a new graphic design, featuring:

- a new interface which adapts to the display device (PC, smartphone, tablet)
- a new user experience which makes Synergy's functions user-friendly for even novice users, leveraging the most recent web-based technologies
- completely user-configurable and manageable reporting.

CHAPTER 30



NFC IOS AND ANDROID APP

Now also available for iOS on the App STORE, LOVATO Electric's NFC app enables device configuration with tablets and smartphones equipped with the NFC technology.

Configuration is possible even when the device is not powered on.

CHAPTER 30

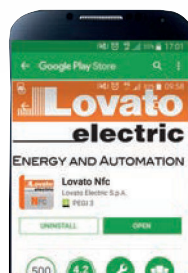
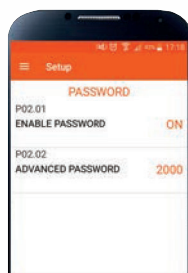
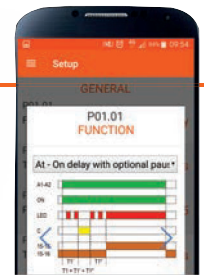
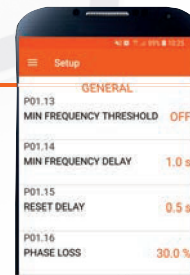
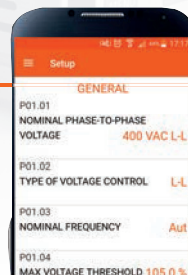
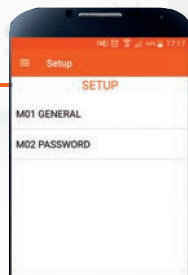

WORLDWIDE



PRODUCTION **SITES**

In addition to its historic Italian head offices, the company has **two factories**: one in the **Czech Republic**, which handles the assembly and testing of electromechanical products, and one in **Croatia** which designs and manufactures cam switches.



Pisek - CZECH REPUBLIC

United Kingdom
LOVATO ELECTRIC LTD
www.Lovato.co.uk

Germany
LOVATO ELECTRIC GmbH
www.LovatoElectric.de

France
LOVATO ELECTRIC SAS
www.LovatoElectric.fr



INTERNATIONAL PRESENCE

Our successful business in Italy has enabled us to open 15 foreign branches (in Germany, the United Kingdom, Czech Republic, Spain, USA, Poland, Canada, Arab Emirates, Turkey, China, Romania, France, Russia, Croatia and Switzerland) and set up a network of 90 importers to assure availability of **LOVATO Electric** products in over 100 countries worldwide.

The presence of **LOVATO Electric** in the major world markets is the result of its ongoing strategy of internationalisation.

Spain
LOVATO ELECTRIC S.L.U.
www.LovatoElectric.es

Poland
LOVATO ELECTRIC SP. Z O.O.
www.LovatoElectric.pl

Czech Republic
LOVATO ELECTRIC S.R.O.
www.LovatoElectric.cz

China
LOVATO ELECTRIC
(SHANGHAI) CO LTD
www.LovatoElectric.cn

Russia
OOO LOVATO ELECTRIC
www.LovatoElectric.ru

Turkey
LOVATO ELEKTRİK LTD
www.LovatoElectric.com.tr

USA
LOVATO ELECTRIC Inc.
www.LovatoUsa.com

Canada
LOVATO ELECTRIC Corp.
www.Lovato.ca

United Arab Emirates
LOVATO ELECTRIC ME FZE
www.LovatoElectric.ae

Romania
LOVATO ELECTRIC SRL
www.LovatoElectric.ro

Croatia
LOVATO KONČAR d.o.o.
www.LovatoElectric.hr

Switzerland
LOVATO ELECTRIC AG
www.LovatoElectric.ch

ITALIAN DESIGN



CERTIFICATED **TOTAL QUALITY**

For us, quality has always been the priority, and since 1992 our

– management system has been certified to **ISO 9001** - making us one of the first in Italy.

The modern concept of quality embraces a wide range of factors, and we also have the following certifications:

- **ISO 14001** for environmental management, the protection and sustainability of the environment in which we live;
- **ISO 50001** for energy management, with the objective of increasing the sustainability of our operations;
- **ISO 45001** for safety, the primary concern in any workplace.



A LONG TRADITION OF STYLE

We have been managing energy since **1922**, led by the same family for four generations, from the early days of electrical engineering to the present day, in which electromechanics, electronics and automation go hand in hand. **Italian design** has always been our hallmark: our designers, researchers and engineering experts work in our Bergamo offices. Our mission is to create **innovative, reliable products**, and offer services to satisfy our customer's requirements.



Bergamo - ITALY

THE COMPONENTS OF SUCCESS

Products that are designed for the most diverse applications and installed all over the world need to meet high standards of reliability. Behind our products is a solid, flexible and innovative organisation with cutting-edge production facilities, where robotics and automation ensure consistent results.

Our test laboratory is fitted out with modern equipment and works together with our design offices to reduce time to market for new products and grow our company know-how.

Certified to EN ISO/IEC 17025, LOVATO LAB is authorised to run tests according to Italian and international standards and issue **ACAE/LOVAG certificates**.

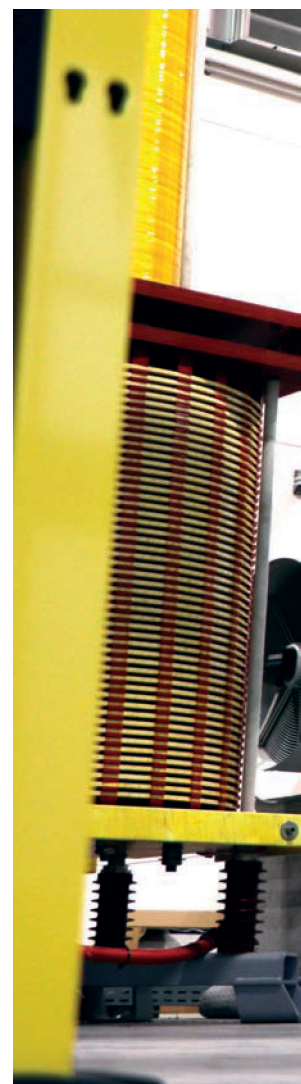



CUTTING-EDGE **LABORATORY**

LOVATO LAB runs:

- short circuit tests per IEC and UL standards up to 30kA current at 600V;
- closure and breaking power tests (overload);
- conventional duty performance tests (endurance) up to 6300A at 690V;
- heating tests up to continuous 3000A in low voltage;
- EMC tests in a semi-anechoic chamber;
- energy metering accuracy tests using high precision current and voltage generators;
- temperature and thermal trip tests;
- synthetic short circuit system up to 65kA and programmable current generators;
- environmental tests using climatic and saline mist chambers for IP protection rating verification;
- impact and vibration tests using a vibrating table;
- studies of physical phenomena using high speed and thermal cameras;
- electrical and mechanical life tests using a large number of test benches and a low voltage synchronous alternator for the power generation up to 1800kVA;
- glow-wire testing of plastic materials using a custom chamber and several dielectric testing stations;
- there is also a 225KV tomograph for testing the most varied and stringent quality requirements, which analyses the structure of parts in their entirety, both internally and externally.

QUALITY CONTROL

LOVATO Electric, with a view to continuous improvement, invests in the professional growth of its employees and in advanced quality control instrumentation and software.

We have modern measurement system capable of satisfying the most varied and stringent quality control requirements, and employ product validation (PPAP), risk analysis (FMEA) and problem solving (8D) methods to guarantee reliability and continuously improve our processes and products.

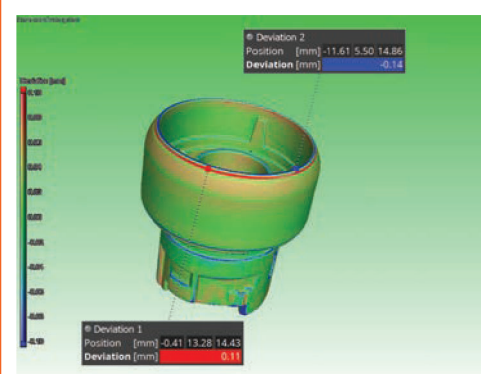

PRODUCTION



MOULD CONSTRUCTION

Our tooling department designs and fabricates the moulds we use to make our plastic components. The department, with its highly experienced and qualified staff and working together with the design office, makes numerous new moulds every year.

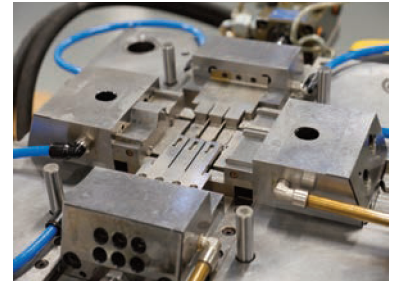

PLASTIC MOULDING

The moulding department has always been one of the company's strategic resources. We have numerous presses, from 50 to 300 tons (both electric bi-component), working 3 eight hour shifts around the clock.



ASSEMBLY

Our assembly department is housed in a large area. It features the most advanced assembly and testing lines. The machines are connected to the company computer system to enable continuous performance monitoring, production programming in line with the Industry 4.0 philosophy, and registration of test and tracking data for each individual product.



TRAINING



LOVATO ACADEMY runs our client training programme. Located at our Bergamo offices, the classroom is equipped with the most recent audiovisual aids and **interactive training benches**, and is the ideal place to learn about the use of our products and their programming and monitoring software.

LOVATO Electric's technical training uses various methods for delivering content in a blended learning approach, combining conventional methods with the teacher in front of the class with remote synchronous training and online tutorials.

Our training programme includes classroom courses, mainly focussed on practical work with the product, live webinars to keep our clients up to date with emerging standards and technologies, and video tutorials, published on our YouTube channel, as an aid to installing and programming our products directly on the client's PC or smartphone.

For more details on our training programme, go to academy.LovatoElectric.com.



EXPERIENCE AND EXPERTISE

To meet the growing demand for technical training of industrial automation and energy management professionals, LOVATO Electric provides a full programme of courses through the **LOVATO Academy**.

The offering includes, among others, courses on: micro PLCs and HMIs, **energy management**, electric motor starting and control, and surge arrestors.

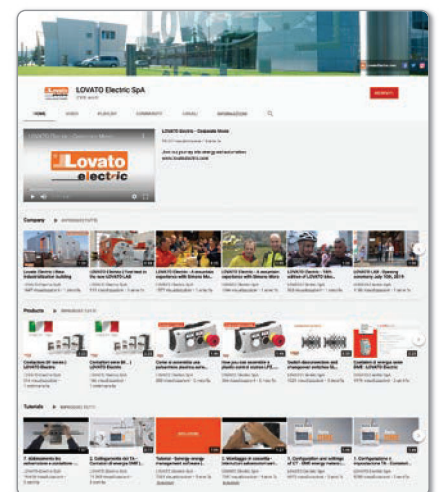

Register with our YouTube channel to see the latest video tutorials and videos about our company.

1 Motor protection circuit breakers

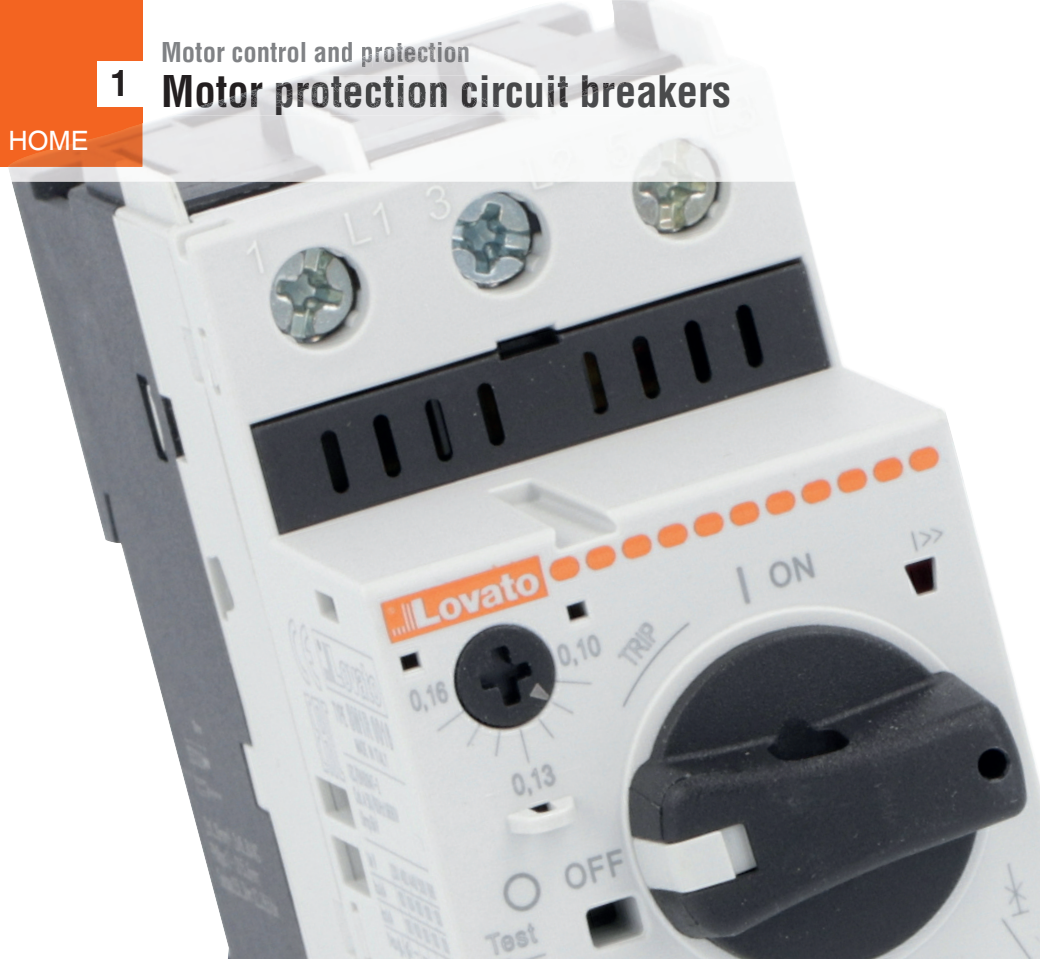

- Wide adjustment range
0.1 to 100A
- IEC breaking capacity Icu 50kA
(400V) up to 100A
- Suitable for isolation
- Certified UL Type E and Type F
- Comprehensive line of accessories
- Magnetic-only version
- Transformer protection version
- Automatic trip indicators
- High reliability and accuracy of tripping.

Motor protection circuit breakers

	SEC. - PAGE
Type E and Type F combination motor controllers	1 - 4
Motor protection circuit breakers SM1... up to 40A. Magnetic and thermal protection	1 - 6
Motor protection circuit breakers SM1RM... up to 40A. Magnetic protection	1 - 6
SM1PF... breakers. Fuse monitoring function	1 - 6
Motor protection circuit breakers SM1RT... up to 25A. Transformer protection	1 - 7
Motor protection circuit breakers SM2... and SM3... from 34 up to 100A. Magnetic and thermal protection	1 - 7
Add-on blocks and accessories for SM1...	1 - 8
Add-on blocks and accessories for SM2... and SM3...	1 - 10

Dimensions	1 - 15
Wiring diagrams	1 - 18
Technical characteristics	1 - 19



Page 1-6

SM1P...

- Motor protection
- Push button control
- Ranges 0.1...40A (16 choices)
- IEC breaking capacity Icu at 400V: from 100 to 10kA
- Suitable for mounting in modular panels.



Page 1-6

SM1R...

- Motor protection
- Rotary knob type
- Ranges 0.1...40A (16 choices)
- IEC breaking capacity Icu at 400V: from 100 to 20kA
- Thermal and magnetic trip indicator
- UL 60947-4-1 Type E, Type F.



Page 1-6

SM1RM...

- Starter protection (magnetic only)
- Rotary knob type
- Rated current from 0.16 to 40A
- IEC breaking capacity Icu at 400V: from 100 to 20kA.



Pag. 1-7

SM1RT...

- Transformer protection
- Rotary knob type
- Ranges 0.1...25A (14 choices)
- Magnetic tripping 20 x In.



Page 1-7

SM2R...

- Motor protection
- Rotary knob type
- Ranges 34...63A (2 choices)
- IEC breaking capacity Icu at 400V: 50kA
- UL 60947-4-1 Type E, Type F.



Page 1-7

SM3R...

- Motor protection
- Rotary knob type
- Ranges 55...100A (3 choices)
- IEC breaking capacity Icu at 400V: 50kA
- Thermal and magnetic trip indicator
- UL 60947-4-1 Type E, Type F.



Page 1-6

SM1PF...

- Fuse monitoring function
- Push button control
- Fixed thermal protection: 0.2A
- Magnetic trip threshold: 1.2A.



LOVATO Electric motor protection circuit breakers are suitable for new motors with high IE3 efficiency values

IEC ratings - short-circuit breaking capacity

Motor protection (magnetic and thermal protection)



SM1P...^⓪



SM1R...

SM2R...

SM3R...

Starter protection (magnetic protection)



SM1RM...

Rated current	0.1...40A				0.1...40A		34...63A		55...100A		0.1...40A					
Thermal protection	●				●		●		●		●					
Magnetic protection	●				●		●		●		●					
TRIP position	●				●		●		●		●					
Phase failure sensitive	●				●		●		●		●					
Padlockable in O	●				●		●		●		●					

Range	230V		400V		440V		500V		690V		230V		400V		440V		500V		690V		230V		400V		440V		500V		690V		
	Icu	Ics	Icu	Ics	Icu	Ics	Icu	Ics	Icu	Ics	Icu	Ics	Icu	Ics	Icu	Ics	Icu	Ics	Icu	Ics	Icu	Ics	Icu	Ics	Icu	Ics	Icu	Ics	Icu	Ics	
[A]	kA	kA	kA	kA	kA	kA	kA	kA	kA	kA	kA	kA	kA	kA	kA	kA	kA	kA	kA	kA	kA	kA	kA	kA	kA	kA	kA	kA	kA	kA	
0.1...0.16	100	100	100	100	100	100	100	100	100	100	100	100	100	100	100	100	100	100	100	100	100	100	100	100	100	100	100	100	100	100	100
0.16...0.25	100	100	100	100	100	100	100	100	100	100	100	100	100	100	100	100	100	100	100	100	100	100	100	100	100	100	100	100	100	100	100
0.25...0.4	100	100	100	100	100	100	100	100	100	100	100	100	100	100	100	100	100	100	100	100	100	100	100	100	100	100	100	100	100	100	100
0.4...0.63	100	100	100	100	100	100	100	100	100	100	100	100	100	100	100	100	100	100	100	100	100	100	100	100	100	100	100	100	100	100	100
0.63...1	100	100	100	100	100	100	100	100	100	100	100	100	100	100	100	100	100	100	100	100	100	100	100	100	100	100	100	100	100	100	100
1...1.6	100	100	100	100	100	100	100	100	100	100	100	100	100	100	100	100	100	100	100	100	100	100	100	100	100	100	100	100	100	100	100
1.6...2.5	100	100	100	100	100	100	100	100	100	3	3	100	100	100	100	100	100	100	100	10	10	100	100	100	100	100	100	100	10	10	10
2.5...4	100	100	100	100	100	100	100	100	100	3	3	100	100	100	100	100	100	100	100	10	10	100	100	100	100	100	100	100	10	10	10
4...6.5	100	100	100	100	100	100	100	100	100	3	3	100	100	100	100	100	100	100	100	4	2	100	100	100	100	100	100	100	4	2	2
6.3...10	100	100	100	100	25	12.5	25	12.5	3	3	100	100	100	100	42	42	42	42	4	2	100	100	100	100	42	42	42	4	2	2	
9...14	100	100	25	12.5	10	5	10	5	3	3	100	100	100	100	42	42	42	42	4	2	100	100	100	100	42	42	42	4	2	2	
13...18	100	50	25	12.5	10	5	10	5	3	3	100	100	100	100	10	5	10	5	4	2	100	100	100	100	10	5	10	5	4	2	
17...23	50	50	15	5	10	5	10	5	3	2	100	100	50	25	10	5	10	5	4	2	100	100	50	25	10	5	10	5	4	2	
20...25	50	50	15	5	10	5	10	5	3	2	100	100	50	25	10	5	10	5	4	2	100	100	50	25	10	5	10	5	4	2	
24...32	50	50	10	5	10	5	10	5	3	2	100	100	50	25	10	5	10	5	4	2	100	100	50	25	10	5	10	5	4	2	
30...40	20	20	10	5	10	5	10	5	3	2	100	100	20	10	10	5	10	5	4	2	100	100	20	25	10	5	10	5	4	2	
34...50	-	-	-	-	-	-	-	-	-	-	100	100	50	50	35	27	10	8	5	5	-	-	-	-	-	-	-	-	-	-	
45...63	-	-	-	-	-	-	-	-	-	-	100	100	50	50	35	27	10	8	5	5	-	-	-	-	-	-	-	-	-	-	
55...75	-	-	-	-	-	-	-	-	-	-	100	100	50	38	40	30	8	6	5	4	-	-	-	-	-	-	-	-	-	-	
70...90	-	-	-	-	-	-	-	-	-	-	100	100	50	38	40	30	8	6	5	4	-	-	-	-	-	-	-	-	-	-	
80...100	-	-	-	-	-	-	-	-	-	-	100	100	50	38	40	30	8	6	5	4	-	-	-	-	-	-	-	-	-	-	

⓪ The fuse monitoring version is also available (on page 1-7)

SM1P... MODULAR SIZE

- Mounting on front of panels or in modular panels for rapid access to buttons, avoiding the opening of the door by non-technical staff.
- Auxiliary contacts, indicator contacts and releases compatible with modular panels.

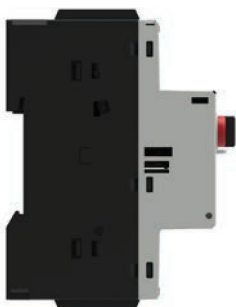

40A IN 45mm

- From 0.1A to 40A in a device just 45mm wide.
- High short-circuit breaking capacity up to 40A.
- Small, cost-effective starters.



SM1R... TRIP INDICATION

- Thermal and magnetic trip indication with trip position of knob.
- Specific optical indication for short-circuit tripping; guarantees maximum safety for operators and reliability of the system.
- Auxiliary trip indication contacts with ability to distinguish overload from short circuit.



SM1... HIGH-PERFORMANCE PLASTICS

- IEC/EN/BS 60335-compliant plastics for domestic and similar applications. Can be used in catering equipment.
- EN 45545-compliant plastics: fire behaviour and emissions of fumes. Suitable for railway applications.

DOOR COUPLING HANDLES

- Padlockable door coupling handles for the entire rotary knob type. Make systems compliant with safety regulations.
- Tough, easy and quick to install.



Transformer protection (magnetic protection 20 x I_n)



SM1RT...

0.1...25A

-
-
-
-
-

UL508 ratings - short-circuit breaking capacity (horse power ratings on page 1-4)



SM1P...



SM1R... - SM2R... - SM3R...

0.1...25A												UL508 / UL 60947-4-1 Manual Motor Controller - Short circuit current in kA												UL508 / UL 60947-4-1 Manual Self Protected Combination Motor Controller (Type E) Short circuit current in kA (Type F ratings see on page 1-5)				
												Motor Disconnect Group Motor Installation	Protection	Motor Disconnect	Group Motor Installation	Protection	Tap Conductor Protection											
												240V	480V	600V		480V	600V	480V	600V		480Y/277V	600Y/347V	240V	480Y/277V	600Y/347V			
I _{cu}	I _{cs}	I _{cu}	I _{cs}	I _{cu}	I _{cs}	I _{cu}	I _{cs}	I _{cu}	I _{cs}	I _{cu}	I _{cs}	I _{cu}	I _{cs}	I _{cu}	I _{cs}	I _{cu}	I _{cs}	I _{cu}	I _{cs}	I _{cu}	I _{cs}	I _{cu}	I _{cs}	I _{cu}	I _{cs}	I _{cu}	I _{cs}	
kA	kA	kA	kA	kA	kA	kA	kA	kA	kA	kA	kA	kA	kA	kA	kA	kA	kA	kA	kA	kA	kA	kA	kA	kA	kA	kA	kA	
-	-	-	-	-	-	-	-	-	-	-	-	50	50	50	⊕	50	50	50	50	⊕	65	50	65	65	50			
100	100	100	100	100	100	100	100	100	100	100	100	50	50	50	⊕	50	50	50	50	⊕	65	50	65	65	50			
100	100	100	100	100	100	100	100	100	100	100	100	50	50	50	⊕	50	50	50	50	⊕	65	50	65	65	50			
100	100	100	100	100	100	100	100	100	100	100	100	50	50	50	⊕	50	50	50	50	⊕	65	50	65	65	50			
100	100	100	100	100	100	100	100	100	100	100	100	50	50	50	⊕	50	50	50	50	⊕	65	50	65	65	50			
100	100	100	100	100	100	100	100	100	100	3	3	30	30	30	100A Class J	30	30	30	30	⊕	65	30	65	65	30			
100	100	100	100	100	100	100	100	100	100	3	3	30	30	30	100A Class J	30	30	30	30	⊕	65	30	65	65	30			
100	100	100	100	100	100	100	100	100	100	3	3	30	30	30	100A Class J	30	30	30	30	⊕	65	30	65	65	30			
100	100	100	100	25	12.5	10	5	10	5	3	3	30	30	30	100A Class J	30	30	30	30	100A Class J	65⊕	30⊕	65⊕	65⊕	30⊕			
100	100	25	12.5	10	5	10	5	3	3	3	3	30	30	-	100A Class J	30	30	30	30	200A Class J	65⊕	30⊕	65⊕	65⊕	30⊕			
100	50	25	12.5	10	5	10	5	3	3	3	3	30	30	-	100A Class J	30	30	30	30	200A Class J	65⊕	-	65⊕	65⊕	-			
50	50	15	5	10	5	10	5	3	2	2	2	5	5	-	⊕	30	30	30	30	200A Class J	30⊕	-	30⊕	30⊕	-			
50	50	15	5	10	5	10	5	3	2	2	2	5	5	-	⊕	30	30	30	30	200A Class J	30⊕	-	30⊕	30⊕	-			
-	-	-	-	-	-	-	-	-	-	-	-	5	5	-	⊕	30	30	30	30	200A Class J	10⊕	-	10⊕	10⊕	-			
-	-	-	-	-	-	-	-	-	-	-	-	5	5	-	⊕	30	30	30	30	200A Class J	-	-	-	-	-			
-	-	-	-	-	-	-	-	-	-	-	-	-	-	-	-	50	10	50	10	⊕	50	10	100	50	-			
-	-	-	-	-	-	-	-	-	-	-	-	-	-	-	-	50	10	50	10	⊕	50	10	100	50	-			
-	-	-	-	-	-	-	-	-	-	-	-	-	-	-	-	40	10	40	10	⊕	40	10	100	40	-			
-	-	-	-	-	-	-	-	-	-	-	-	-	-	-	-	40	10	40	10	⊕	40	10	100	40	-			
-	-	-	-	-	-	-	-	-	-	-	-	-	-	-	-	40	10	40	10	⊕	40	10	100	40	-			

⊕ Fuse or CB ⊕ Values valid for SM1RE... only

ENCLOSURES

- Various types of plastic enclosures are available for rotating and button-controlled motor protection circuit breakers up to 40A.
- Surface and flush mount.
- Ideal for small machines and isolated motors.
- IP65 (UL Type 4X) protection rating and UV-ray resistant.
- Very robust plastics, IK07; pass even the strict UL "ball impact" test.
- UL-certified.



SM1... PADLOCKABLE

- All of the devices, in both the rotary knob type and push button controlled motor protection circuit breaker range, are padlockable. This provides greater operator safety during maintenance and bypassing of equipment.



UL Type E

- The entire rotary knob type is certified UL Type E.
- Type E is a specific requirement of the UL standards that requires, of short-circuit protection devices, increased terminal isolation distances and strict breaking capacity tests.
- Eliminates the need for further short-circuit protection devices upstream of the motor protection.

UL Type F



- Type F starters are a combination of a motor protection circuit breaker and a contactor tested in specified short circuit conditions to verify their coordination.
- The SM1R motor protection circuit breakers are certified UL type F in combination with BG and BF contactors.
- A Type F starter is the most complete and preferred way to control and protect a motor.

UL ratings

Type E and Type F combination motor controllers

The UL standard indicates a combination motor controller, also called a combination starter, as equipment consisting of a protected starter incorporating an isolation function. The protection includes both thermal overload and short circuit. In the standard of UL508 (now harmonized with IEC as UL 60947-4-1), we can find

different construction types of starters stated as Type A, Type B, etc... composed of different type of devices intended to control, disconnect and protect a motor. Type E and Type F controllers usually provide the best solution to control and protect a motor.

Type E	Type F
<p>A Type E starter is a listed combination starter suitable for use without additional upstream circuit short-circuit protection. The typical Type E starter is a motor protection circuit breaker (MPCB), also known as manual motor protector that includes in a single device the following functions: manual motor control, disconnection, short circuit protection and motor overload protection. A "NON Type E" motor protection circuit breaker, despite including short circuit protection, requires additional upstream short circuit protection.</p> <p>FUNCTIONS:</p> <ul style="list-style-type: none"> - Disconnect - Branch circuit protection - Motor control - Motor overload protection. 	<p>A Type F starter has the same functions of Type E but in addition to the motor protection circuit breaker (MPCB) commonly known as manual motor protector, also includes a contactor to have remote or automatic control of the motor.</p> <p>FUNCTIONS:</p> <ul style="list-style-type: none"> - Disconnect (MPCB) - Branch circuit protection (MPCB) - Motor control (contactor) - Motor overload protection (MPCB).
 <ul style="list-style-type: none"> ● Phase separation barrier (required^①) ● Motor protection circuit breaker also known as manual motor protector 	 <ul style="list-style-type: none"> ● Phase separation barrier (required^①) ● Motor protection circuit breaker also known as manual motor protector ● Rigid connection (optional) ● Contactor

^① Code SM1X9000R or SM1X9050.

CO-ORDINATION TYPE 1 AND CO-ORDINATION TYPE 2

The concept of co-ordination Type 1 and Type 2 was recently introduced in the UL 60947-4-1.

In the co-ordination Type 1, after a short-circuit, the starter shall cause no danger to persons or installation, but may not be suitable for further service and may need parts repair and replacement.

In the co-ordination Type 2, after a short-circuit, the starter shall cause no danger to persons or installation and is suitable for further use.

On the next page the co-ordination tables are provided.

TAP CONDUCTOR PROTECTION

SM... motor protection circuit breakers are also suitable as Tap Conductor Protection for Group Installation.

When manual motor starters are employed in group installations, in specified conditions by the standard, it is possible to reduce the wire sections.

The use of smaller wires reduces the cost of the panel and makes the wiring easier. Furthermore, these motor protection circuit breakers can be used for control transformers protection instead of fuses or circuit breaker certified as UL 489.

Maximum UL/CSA horsepower ratings

		Single-phase		Three-phase, 3-pole			
		110V-120V	220V-240V	200V-208V	220-240V	440/-480V	550V-600V
		[HP]	[HP]	[HP]	[HP]	[HP]	[HP]
SM1R0016	SM1P0016	-	-	-	-	-	
SM1R0025	SM1P0025	-	-	-	-	-	
SM1R0040	SM1P0040	-	-	-	-	-	
SM1R0063	SM1P0063	-	-	-	-	-	
SM1R0100	SM1P0100	-	-	-	-	1/2	
SM1R0160	SM1P0160	-	1/10	-	-	3/4	
SM1R0250	SM1P0250	-	1/6	1/2	1/2	1	
SM1R0400	SM1P0400	1/8	1/3	3/4	3/4	2	
SM1R0650	SM1P0650	1/4	1/2	1.5	1.5	3	
SM1R1000	SM1P1000	1/2	1.5	2	3	5	
SM1R1400 / SM1RE1400	SM1P1400	3/4	2	3	3	10	
SM1R1800 / SM1RE1800	SM1P1800	1	3	5	5	10	
SM1R2300 / SM1RE2300	SM1P2300	1.5	3	5	7.5	15	
SM1R2500 / SM1RE2500	SM1P2500	2	3	5	7.5	15	
SM1R3200 / SM1RE3200	SM1P3200	2	5	10	10	20	
SM1R4000	SM1P4000	3	7.5	10	10	30	
SM2R5000	—	3	10	15	15	30	
SM2R6300	—	5	10	20	20	40	
SM3R7500	—	5	15	20	25	50	
SM3R9000	—	7 1/2	20	25	30	60	
SM3R9900	—	10	20	30	30	75	

^① SM1R... and SM1RE... only

Combination Motor Controllers (Type F)

Coordination Type 1 - In the co-ordination Type 1, after a short-circuit, the starter shall cause no danger to persons or installation, but may not be suitable for further service and may need parts repair and replacement.

Motor protection circuit breaker type	Thermal setting range [A]	Contactor types	SCCR in kA		
			240V	480Y/277V	600Y/347V
SM1R0016	0.1...0.16	BG06...BG12, BF09...BF38	65	65	50
SM1R0025	0.16...0.25	BG06...BG12, BF09...BF38	65	65	50
SM1R0040	0.25...0.4	BG06...BG12, BF09...BF38	65	65	50
SM1R0063	0.4...0.63	BG06...BG12, BF09...BF38	65	65	50
SM1R0100	0.63...1	BG06...BG12, BF09...BF38	65	65	50
SM1R0160	1...1.6	BG06...BG12, BF09...BF38	65	65	50
SM1R0250	1.6...2.5	BG06...BG12, BF09...BF38	65	65	30
SM1R0400	2.5...4	BG06...BG12, BF09...BF38	65	65	30
SM1R0650	4...6.5	BG06...BG12, BF09...BF38	65	65	30
SM1RE1000	6.3...10	BF09...BF38	65	65	30
SM1RE1400	9...14	BF18...BF38	65	65	30
SM1RE1800	13...18	BF18...BF38	65	65	-
SM1RE2300	17...23	BF18...BF38	30	30	-
SM1RE2500	20...25	BF25...BF38	30	30	-
SM1RE3200	24...32	BF32, BF38	10	10	-
SM2R5000	34...50	BF40...BF150	50	50	-
SM2R6300	45...63	BF50...BF150	50	50	-
SM3R7500	55...75	BF65...BF150	40	40	-
SM3R9000	70...90	BF80...BF150	40	40	-
SM3R9900	80...100	BF115...BF150	40	40	-

● BG06 not for 600Y/347V.

Coordination Type 2 - In the co-ordination Type 2, after a short-circuit, the starter shall cause no danger to persons or installation and is suitable for further use.

Motor protection circuit breaker type	Thermal setting range [A]	Contactor types	SCCR in kA		
			240V	480Y/277V	600Y/347V
SM1R0016	0.1...0.16	BF26, BF32, BF38	65	65	50
SM1R0025	0.16...0.25	BF26, BF32, BF38	65	65	50
SM1R0040	0.25...0.4	BF26, BF32, BF38	65	65	50
SM1R0063	0.4...0.63	BF26, BF32, BF38	65	65	50
SM1R0100	0.63...1	BF26, BF32, BF38	65	65	50
SM1R0160	1...1.6	BF26, BF32, BF38	65	65	50
SM1R0250	1.6...2.5	BF26, BF32, BF38	65	65	30
SM1R0400	2.5...4	BF26, BF32, BF38	65	65	30
SM1R0650	4...6.5	BF26, BF32, BF38	65	65	30
SM1RE1000	6.3...10	BF26, BF32, BF38	65	65	30
SM1RE1400	9...14	BF26, BF32, BF38	65	65	30
SM1RE1800	13...18	BF26, BF32, BF38	65	65	-
SM1RE2300	17...23	BF26, BF32, / BF38	10 / 30	10 / 30	-
SM1RE2500	20...25	BF26, BF32, / BF38	10 / 30	10 / 30	-
SM1RE3200	24...32	BF32, BF38	10	10	-
SM2R5000	34...50	BF95, BF115, BF150	50	50	-
SM2R6300	45...63	BF95, BF115, BF150	50	50	-
SM3R7500	55...75	BF95, BF115, BF150	40	40	-
SM3R9000	70...90	BF95, BF115, BF150	40	40	-
SM3R9900	80...100	BF115, BF150	40	40	-

Motor protection circuit breakers SM1... up to 40A. Magnetic and thermal protection



SM1P...



SM1R...

- ❶ For SM1R... breakers, certified UL Type E, add E letter to the code. Ex. SM1RE1000.
- ❷ 10 x In max for 0.1...0.16A and 0.16...0.25A setting ranges.
- ❸ Intended specifically for monitoring the status of fuses:
 - rated current: 0.2A
 - magnetic tripping: 1.2A.

Order code	Thermal trip adjustment range		Short circuit breaking capacity at 400V		Qty per pkg	Wt [kg]
	[A]	[A]	Icu [kA]	Ics [kA]		
Push button control. For UL ratings see page 1-14.						
SM1P0016	0.1...0.16		100	100	1	0.240
SM1P0025	0.16...0.25		100	100	1	0.240
SM1P0040	0.25...0.4		100	100	1	0.240
SM1P0063	0.4...0.63		100	100	1	0.240
SM1P0100	0.63...1		100	100	5	0.260
SM1P0160	1...1.6		100	100	5	0.270
SM1P0250	1.6...2.5		100	100	5	0.300
SM1P0400	2.5...4		100	100	5	0.300
SM1P0650	4...6.5		100	100	5	0.300
SM1P1000	6.3...10		100	100	5	0.300
SM1P1400	9...14	25	12.5	5	0.300	
SM1P1800	13...18	25	12.5	5	0.300	
SM1P2300	17...23	15	5	1	0.300	
SM1P2500	20...25	15	5	1	0.300	
SM1P3200	24...32	10	5	1	0.300	
SM1P4000	30...40	10	5	1	0.300	
SM1PF0020❸	0.20		100	100	5	0.280
Rotary knob type. For UL ratings see page 1-14.						
SM1R0016	0.1...0.16		100	100	1	0.270
SM1R0025	0.16...0.25		100	100	1	0.270
SM1R0040	0.25...0.4		100	100	1	0.278
SM1R0063	0.4...0.63		100	100	1	0.278
SM1R0100	0.63...1		100	100	5	0.280
SM1R0160	1...1.6		100	100	5	0.280
SM1R0250	1.6...2.5		100	100	5	0.340
SM1R0400	2.5...4		100	100	5	0.340
SM1R0650	4...6.5		100	100	5	0.340
SM1R1000❶	6.3...10		100	100	5	0.340
SM1R1400❶	9...14		100	100	5	0.340
SM1R1800❶	13...18		100	100	5	0.340
SM1R2300❶	17...23	50	25	1	0.340	
SM1R2500❶	20...25	50	25	1	0.340	
SM1R3200❶	24...32	50	25	1	0.340	
SM1R4000	30...40	20	10	1	0.340	

General characteristics

SM1P... and SM1R... are modern circuit breakers with thermal and magnetic trip releases and high breaking capacity. Motor control and protection of up to 22kW (400V) are possible by choosing the suitable adjustment range, 0.1 to 40A. The dimensions of SM1P... breakers are compliant with the DIN 43880 standard, allowing them to be mounted in all modular enclosures on the market.

A magnetic trip indicator integrated on the SM1R... breakers avoids dangerous closing operations during short-circuit conditions, previously disconnected by the breaker. SM1R... up to 32A breakers, with SM1X9000R or SM1X9050 accessory, are Type E-certified according to UL 60947-4-1; only for range from 6.5 to 32A the Type E version must be ordered with specific code SM1RE...❶. SM1R... motor protection circuit breakers combined with BG... and BF... contactors are Type F certified in compliance with UL 60947-4-1 standard (see page 1-4 and 1-5).

SM1P... and SM1R... motor protection circuit breakers are suitable for isolation in accordance with IEC/EN/BS 60947 standards and can be padlocked in OFF position without using accessories. Their high breaking capacity consents to exclude protection fuses on the majority of the installations.

Operational characteristics

- IEC rated insulation voltage Ui: 690V
- IEC rated impulse withstand voltage: 6kV
- IEC rated frequency: 50/60Hz
- Maximum rated current: 40A
- Adjustment ranges: 16
- IEC breaking capacity: See table on page 1-2
- Heat dissipation per phase: 0.7...3.3W
- Magnetic tripping: 13 x In max.❷
- Tripping class: 10A
- Phase failure sensitive
- Mechanical and electrical life: 100,000 cycles
- Mounting on 35mm DIN rail (IEC/EN/BS 60715)
- Mounting position: Any
- IEC utilisation category: A
- Padlocking in OFF: Ø4mm/0.16"
- IEC degree of protection: IP20.

Certifications and compliance

Certifications obtained: cULus, EAC. SM1R... circuit breakers are Type E and Type F certified (Self-Protected Combination Motor Controllers) according to UL 60947-4-1. Certifications pending: CCC. Compliant with standards: IEC/EN/BS 60947-1, IEC/EN/BS 60947-2, IEC/EN/BS 60947-4-1, UL 60947-4-1, CSA C22.2 n° 60947-1, CSA C22.2 n° 60947-4-1. Plastic materials compliant with standards: IEC/EN/BS 60335 and EN/BS 45545.

Motor protection circuit breakers SM1RM... up to 40A. Magnetic protection



SM1RM...

- ❹ 10In max for 0.1...0.16A and 0.16...0.25A setting ranges.

Order code	Rated and magnetic trip current		Short circuit breaking capacity at 400V		Qty per pkg	Wt [kg]
	Rat. [A]	Trip. [A]	Icu [kA]	Ics [kA]		
Rotary knob type. For UL ratings see page 1-14.						
SM1RM0016	0.16	1.6	100	100	1	0.270
SM1RM0025	0.25	3.2	100	100	1	0.270
SM1RM0040	0.4	5.2	100	100	1	0.278
SM1RM0063	0.63	8.2	100	100	1	0.278
SM1RM0100	1	13	100	100	5	0.280
SM1RM0160	1.6	21	100	100	5	0.280
SM1RM0250	2.5	33	100	100	5	0.340
SM1RM0400	4	52	100	100	5	0.340
SM1RM0650	6.5	85	100	100	5	0.340
SM1RM1000	10	130	100	100	5	0.340
SM1RM1400	14	182	100	100	5	0.340
SM1RM1800	18	234	100	100	5	0.340
SM1RM2300	23	299	50	25	1	0.340
SM1RM2500	25	325	50	25	1	0.340
SM1RM3200	32	416	50	25	1	0.340
SM1RM4000	40	420	20	10	1	0.340

General characteristics

SM1RM... are motor protection circuit breakers with magnetic tripping only and high breaking capacity. They are typically used to protect starters where there is a thermal relay or other overload protection. Starter control and protection of up to 22kW (400V) are possible by choosing the suitable adjustment range, from 0.1 to 40A.

Operational characteristics

- IEC rated insulation voltage Ui: 690V
- IEC rated impulse withstand voltage: 6kV
- IEC rated frequency: 50/60Hz
- Maximum rated current: 40A
- IEC breaking capacity: See table on page 1-3
- Heat dissipation per phase: 0.7...3.3W
- Magnetic tripping: 13 x In max.❷
- Mechanical and electrical life: 100,000 cycles
- Mounting on 35mm DIN rail (IEC/EN/BS 60715)
- Mounting position: Any
- IEC utilisation category: A
- Padlocking in OFF: Ø4mm
- IEC degree of protection: IP20.

Certifications and compliance

Certifications obtained: cULus, EAC. Certifications pending: CCC. Compliant with standards: IEC/EN/BS 60947-1, IEC/EN/BS 60947-2, IEC/EN/BS 60947-4-1, UL 60947-4-1, CSA C22.2 n° 60947-1, CSA C22.2 n° 60947-4-1. Plastic materials compliant with standards: IEC/EN/BS 60335 and EN/BS 45545.

Motor protection circuit breakers SM1RT... up to 25A. Transformer protection



SM1RT...

⊕ 16 x In for 0.1...0.16A setting range.

Order code	Thermal trip adjustment range	Short circuit breaking capacity at 400V		Qty per pkg	Wt [kg]
		Icu [kA]	Ics [kA]		
	[A]	[kA]	[kA]	n°	[kg]
Rotary knob type.					
SM1RT0016	0.1...0.16	100	100	1	0.270
SM1RT0025	0.16...0.25	100	100	1	0.270
SM1RT0040	0.25...0.4	100	100	1	0.278
SM1RT0063	0.4...0.63	100	100	1	0.278
SM1RT0100	0.63...1	100	100	5	0.280
SM1RT0160	1...1.6	100	100	5	0.280
SM1RT0250	1.6...2.5	100	100	5	0.340
SM1RT0400	2.5...4	100	100	5	0.340
SM1RT0650	4...6.5	100	100	5	0.340
SM1RT1000	6.3...10	100	100	5	0.340
SM1RT1400	9...14	25	12.5	5	0.340
SM1RT1800	13...18	25	12.5	5	0.340
SM1RT2300	17...23	15	5	1	0.340
SM1RT2500	20...25	15	5	1	0.340

General characteristics

SM1RT... are circuit breakers with thermal and magnetic trip releases intended specifically for transformers control and protection. The magnetic trip threshold of 20 x In enable the connection of transformers avoiding unintentional tripping due to the high in-rush currents. The various adjustment ranges from 0.1A to 25A enable control and protection of transformers up to 17kVA (400V).

Operational characteristics

- IEC rated insulation voltage Ui: 690V
- IEC rated impulse withstand voltage: 6kV
- IEC rated frequency: 50/60Hz
- Maximum rated current: 25A
- IEC breaking capacity: See table on page 1-3
- Max. heat dissipation per phase: 0.7...3.4W
- Magnetic tripping: 20 x In max[⊕]
- Mechanical and electrical life: 100.000 cycles
- Mounting on 35mm DIN rail (IEC/EN/BS 60715)
- Mounting position: Any
- IEC utilisation category: A
- Padlocking in OFF: Ø4mm/0.16"
- IEC degree of protection: IP20.

Certifications and compliance

Certifications obtained: cULus, EAC. Compliant with standards: IEC/EN/BS 60947-1, IEC/EN/BS 60947-2, IEC/EN/BS 60947-4-1, UL 60947-4-1, CSA C22.2 n° 60947-1, CSA C22.2 n° 60947-4-1. Plastics compliant with standards: IEC/EN/BS 60335 and EN/BS 45545.

Motor protection circuit breakers SM2... and SM3... up to 100A. Magnetic and thermal protection



SM2R...



SM3R...

Order code	Thermal trip adjustment range	Short circuit breaking capacity at 400V		Qty per pkg	Wt [kg]
		Icu [kA]	Ics [kA]		
	[A]	[kA]	[kA]	n°	[kg]
Rotary knob type. For UL ratings see page 1-14.					
SM2R5000	34...50	50	50	1	1.000
SM2R6300	45...63	50	50	1	1.000
Rotary knob type. For UL ratings see page 1-14.					
SM3R7500	55...75	50	38	1	2.200
SM3R9000	70...90	50	38	1	2.200
SM3R9900	80...100	50	38	1	2.200

General characteristics

SM2R... and SM3R... are modern circuit breakers with thermal and magnetic trip releases and high breaking capacity. Motor control and protection, up to 55kW (400V) are possible by choosing the suitable adjustment range, up to 100A. SM2R... and SM3R... breakers are Type E and Type F according to UL 60947-4-1.

The SM2R... and SM3R... types are suitable for isolation according to IEC/EN/BS 60947 standards and can be padlocked in OFF position without using accessories. SM2R... and SM3R... have a trip function which indicates thermal and magnetic tripping. Their high breaking capacity removes the need for back up fuse protection on the majority of installations.

Operational characteristics

- IEC rated insulation voltage Ui: 1000V
- IEC rated impulse withstand voltage: 8kV
- IEC rated frequency: 50/60Hz
- Maximum rated current: 63A (for SM2...); 100A (for SM3...)
- Adjustment ranges: 2 (for SM2...); 3 (for SM3...)
- IEC breaking capacity: See table on page 1-2 and 1-3
- Max. heat dissipation per phase: 7W
- Magnetic tripping: 13 x In max.
- Tripping class: 10A
- Phase failure sensitive
- Mechanical life: 50.000 cycles
- Electrical life: 25.000 cycles
- Mounting on 35mm DIN rail (IEC/EN/BS 60715)
- Mounting position: Any
- IEC utilisation category: A
- Padlocking in OFF: Ø4mm/0.16"
- IEC degree of protection: IP20 on front.

Certifications and compliance

Certifications obtained: cULus, EAC. SM2... and SM3... circuit breakers are Type E and Type F certified (Self-Protected Combination Motor Controllers) according to UL 60947-4-1; for Type E and Type F, SM3 only with accessory SM3X9000R. Compliant with standards: IEC/EN/BS 60947-1, IEC/EN/BS 60947-2, IEC/EN/BS 60947-4-1, UL 60947-4-1, CSA C22.2 n° 60947-1, CSA C22.2 n° 60947-4-1.

1 Motor protection circuit breakers

Add-on blocks and accessories for SM1...



SM1X11...



SM1X12...



SM1X1311



SM1X1311M



SM1X14...



SM1X15...R



SM1X15...P



SM1X16...



SM1X18200R



SM1X18S

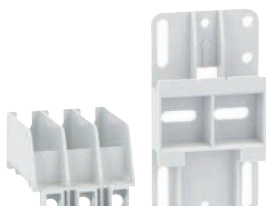

SM1X9000R



BFX8901



SM1X8902

Order code	Characteristics	Qty	Wt
		per pkg	
		n°	[kg]

Add-on auxiliary contacts.

SM1X1120	Front mount 2NO	10	0.016
SM1X1111	Front mount 1NO+1NC	10	0.016
SM1X1220	Side mount 2NO	1	0.036
SM1X1211	Side mount 1NO+1NC	10	0.036
SM1X1202	Side mount 2NC	1	0.036
SM1X1311	Side mount. Contacts for thermal and magnetic tripping indication 1NO+1NC	1	0.036
SM1X1311M	Side mount. Contacts for magnetic tripping indication 1NO+1NC	1	0.036

Undervoltage trip releases.

SM1X14024	24VAC 50Hz	1	0.130
SM1X14110	110VAC 50Hz; 120VAC 60Hz	1	0.130
SM1X1422060	220VAC 60Hz	1	0.130
SM1X14230	230VAC 50Hz	1	0.130
SM1X14400	400VAC 50Hz; 440VAC 60Hz	1	0.130
SM1X1457560	575VAC 60Hz	1	0.130
SM1X15024①	With early-make contacts 24VAC 50Hz	1	0.140
SM1X15110①	With early-make contacts 110VAC 50Hz; 120VAC 60Hz	1	0.140
SM1X15230①	With early-make contacts 230VAC 50Hz	1	0.140
SM1X15400①	With early-make contacts 400VAC 50Hz	1	0.140

Shunt trip releases.

SM1X16024	24VAC 50/60Hz	1	0.130
SM1X16110	110VAC 50/60Hz	1	0.130
SM1X16230	230VAC 50/60Hz	1	0.130
SM1X16400	400VAC 50/60Hz	1	0.130

Adjuster sealing kit.

SM1X1812	With wire and lead included	1	0.006
-----------------	-----------------------------	---	-------

IP65 (4X) padlockable door coupling handle for SM1R...

SM1X18200R	Red/yellow complete with rod length 200mm/7.87"	1	0.115
SM1X18B200R	Black complete with rod length 200mm/7.87"	1	0.115
SM1X18S②	Support for rod >145mm/5.71"	1	0.030

Phase separation barriers for SM1R...

SM1X9000R	For Type E and Type F as UL60947-4-1	5	0.016
------------------	--------------------------------------	---	-------

Three-phase connection busbars 45mm/1.77" spacing.

11SMX9032	For 2 breakers	10	0.028
11SMX9033	For 3 breakers	10	0.050
11SMX9034	For 4 breakers	10	0.071
11SMX9035	For 5 breakers	10	0.092

Three-phase connection busbars 54mm/2.13" spacing.

11SMX9042	For 2 breakers	10	0.031
11SMX9043	For 3 breakers	10	0.056
11SMX9044	For 4 breakers	10	0.081
11SMX9045	For 5 breakers	10	0.090

Terminal block for busbar supply.

11SMX9030	For all busbar types	10	0.048
SM1X9050	For all busbar types Type E and F as per UL508 / UL60947-4-1	10	0.050

Safety cover.

11SMX9031	For unused terminals	10	0.004
------------------	----------------------	----	-------

Accessories for motor protection breaker fixing.

SM1X8902	Metal bracket for fixing SM1... motor protection with screws	10	0.006
BFX8901	Universal plastic base for screw-fixing SM1... motor protection circuit breaker	2	0.016

General and operational characteristics

ADD-ON AUXILIARY CONTACTS

- Connectable to the left side of the breaker or on the front
- Maximum combinations: 3 SM1X... blocks with 6 auxiliary contacts in total of which 1 front block and 2 side blocks
- IEC conventional free air thermal current I_{th}: 10A (5A for SM1X11...)
- IEC rated insulation voltage U_i: 690V (300V for SM1X11...)
- Rated impulse withstand voltage U_{imp}: 4kV
- UL/CSA and IEC/EN/BS 60947-5-1 designation: A600 - Q600 (C300 - R300 for SM1X11...)
- Maximum tightening torque: 1Nm / 9lb.in
- Conductor cross section minimum-maximum (1 or 2 wires): 0.75...2.5mm² or 18...14AWG.
- Screw tightening tool: Phillips 2
- Maximum tightening torque: 1Nm / 9lb.in
- Width of side-mount auxiliary contacts equal to 0.5 DIN 46880 modules
- IEC degree of protection: IP20.

UNDERVOLTAGE TRIP RELEASES

- Snap on to the right side of the breaker
- Consumption inrush/holding: 12/3.5VA
- Release voltage: 0.35...0.7Us
- Operating voltage: 0.85...1.1Us
- Maximum tightening torque: 1Nm / 9lb.in
- Conductor cross section minimum-maximum (1 or 2 wires): 0.75...2.5mm² or 18...14AWG.
- Screw tightening tool: Phillips 2
- Maximum tightening torque: 1Nm / 9lb.in
- Width of side-mount undervoltage trip releases equal to 1 DIN 46880 module
- IEC degree of protection: IP20.

SHUNT TRIP RELEASES

- Snap on to the right side of the breaker
- In-rush consumption: 20VA
- Operating voltage: 0.7...1.1Us
- Conductor cross section minimum-maximum (1 or 2 wires): 0.75...2.5mm² or 18...14AWG.
- Screw tightening tool: Phillips 2
- Maximum tightening torque: 1Nm / 9lb.in
- Width of side-mount shunt trip releases equal to 1 standard DIN 46880 module
- IEC degree of protection: IP20.

PADLOCKABLE DOOR COUPLING HANDLE FOR SM1R...

- IEC degree of protection: IP65
- Degree of protection according to UL: Type 1, 2, 3R, 12, 12K, 4, 4X; external use
- Adjustable rod from 48 to 212mm (1.89" to 8.35")
- Ring-fixing in 22mm/0.87" hole.

THREE-PHASE CONNECTION BUSBARS

- I_{max}: 63A
- SMX903... 45mm/1.77" spacing to reduce the width to the minimum
- SMX904... 54mm/2.13" spacing to consent to fit one side-mount auxiliary contact block on the breaker.

TERMINAL BLOCKS FOR BUSBAR SUPPLY

- I_{max}: 63A
- Screw tightening tool: Phillips 2
- Maximum tightening torque: 2.3Nm / 20lb.in
- Conductor cross section minimum-maximum: 4...25mm² or 10...4AWG.

Certifications and compliance

Certifications obtained: cULus (except terminal block for busbar supply), EAC.
 Certifications pending: CCC.
 Compliant with standards: IEC/EN/BS 60947-1, IEC/EN/BS 60947-5-1, UL 60947-4-1, CSA C22.2 n° 60947-1, CSA C22.2 n° 60947-4-1.

① Complete the order code by indicating P for mounting on SM1P... motor protection circuit breakers, or R for SM1R... motor protection circuit breakers.
 ② Mounting also possible with side-mount auxiliary contacts SM1X12... and SM1X13...

1 Motor protection circuit breakers

Add-on blocks and accessories for SM1...



SM1X30...

SM1X31...
SM1X32...



SM1Z1701P

SM1Z1702P



SM1Z1705P

SM1Z1715R



SM1Z1725R



SM1X1740P

SM1X1745P

SM1X1746P



SM1X17024R

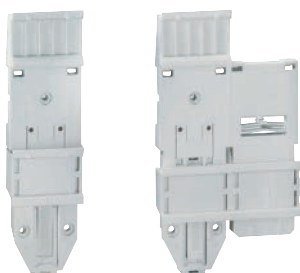

11SMX9010

11SMX9012

Order code	Characteristics	Qty per pkg	Wt
		n°	[kg]
Rigid SM1 breaker-contactor connections.			
SM1X3040P	For motor protection breaker SM1P... with BG... mini-contactors	10	0.019
SM1X3141P	For motor protection breaker SM1P... with BF09..25A contactors	10	0.035
SM1X3241P	For motor protection breaker SM1P... with BF26..38A contactors	10	0.045
SM1X3040R	For motor protection breaker SM1R... with BG... mini-contactors	10	0.019
SM1X3141R	For motor protection breaker SM1R... with BF09..25A contactors	10	0.035
SM1X3142R	For motor protection breaker SM1R... with contactors BF09..25D and BF09...25L	10	0.044
SM1X3241R	For motor protection breaker SM1R... with contactors BF26..38A	10	0.045
Surface mount enclosures IP65 (4X) for SM1P...			
SM1Z1701P	Width 80mm/3.15" ①	1	0.235
SM1Z1702P	Width 80mm/3.15". With button for emergency stop	1	0.275
SM1Z1711P	Width 100mm/3.94" ①	1	0.315
SM1Z1712P	Width 100mm/3.94". With button for emergency stop	1	0.345
Flush mount enclosure IP65 (4X) for SM1P...			
SM1Z1705P	Width 87mm/3.42" ①	1	0.205
Surface mount enclosures IP65 (4X) for SM1R...			
SM1Z1715R	With rotary actuator red/yellow. Width 100mm/3.94"	1	0.350
SM1Z1710R	With black rotary actuator. Width 100mm/3.94"	1	0.350
Flush mount enclosures IP65 for SM1R (UL type 4X)			
SM1Z1725R	With rotary actuator yellow/red. Width 87mm/3.42"	1	0.245
SM1Z1720R	With rotary actuator black. Width 87mm/3.42"	1	0.245
ENCLOSURE ACCESSORIES AND SPARE PARTS. For SM1Z...P enclosures.			
SM1X1740P	Emergency stop button. IP65 (4X)	1	0.044
SM1X1745P	Rubber membrane with rim. IP65 (4X)	1	0.016
SM1X1746P	Lockable block. IP65 (4X)	1	0.030
LED pilot lights IP65. Wire length 200mm/7.87".			
SM1X17024G	Green 24VAC/DC	1	0.007
SM1X17024R	Red 24VAC/DC	1	0.007
SM1X17400G	Green 110...400VAC	1	0.007
SM1X17400R	Red 110...400VAC	1	0.007
Plastic M25 to 1/2" NPT entry adapter.			
11LMM25PG16	For enclosures SM1Z1701P and SM1Z1702P	10	0.009
Starter assembly adapter plates.			
11SMX9010	Adapter plate for direct starter comprising breaker SM1... and contactor BG..., BF09A...BF38A	1	0.058
11SMX9012	Adapter plate for reversing switch comprising breaker for motor protection SM1... contactors BG..., BF09A...BF38A	1	0.095
11SMX9014	Adapter plate for starter star-delta comprising motor protection breaker SM1... and contactors BF09A...BF38A	1	0.118
11SMX9018	35mm rail for passage of wires underneath to contactor; for SMX90 14	1	0.025
11SMX9019	DIN rail extension 35mm/1.38"	1	0.025

General and operational characteristics

RIGID SM1 BREAKER-CONTACTOR CONNECTIONS

The SM1X3... connections electrically and mechanically fasten the motor protection breaker together with the contactor. This forms a highly compact single-unit starter for quick installation on a single 35mm DIN rail.

The SM1X3... connections can also be mounted in combination with reversing and star-delta starters made with the rigid connections indicated in section 2.

SURFACE MOUNT ENCLOSURES

- Top or bottom cable entry:
- SM1Z1701P and SM1Z1702P 4 M25-threaded knock-outs
- SM1Z1711P and SM1Z1712P 4 knock-out with Ø20.5mm/0.81" or Ø26.5mm/1.04"
- SM1Z1710R e SM1Z1715R 4 - knock-out with Ø20.5mm/0.81" or Ø26.5mm/1.04"
- Possibility of rear entry too
- Protection rating: IP65 (UL Type 4X)
- Holds a breaker, one front-mount auxiliary contact block either one shunt or undervoltage release and one pilot light; only for enclosures 100mm/3.94" width side mount auxiliary contact blocks can be fitted as well
- The SM1Z1710R and SM1Z1715R rotary actuators can be padlocked with a maximum of 3 padlocks Ø4...8mm/0.16...0.31"
- Earth/ground terminal included
- Operating temperature: -25...+60°C
- Storage temperature: -50...+80°C.

FLUSH MOUNT ENCLOSURES FOR SM1P AND SM1R

- Holds a SM1P breaker, one front-mount auxiliary contact block and either one shunt or undervoltage release
- Protection rating: IP65 (UL Type 4X)
- Earth/ground terminal included
- 70x115mm/2.76x4.53" cutout for SM1P
- 70x143mm/2.77x5.65" cutout for SM1R
- Operating temperature: -25...+60°C
- Storage temperature: -50...+80°C.

ENCLOSURE ACCESSORIES

Emergency stop button:

- Turn to release
- Red button Ø35mm/1.38".

Lockable block:

- Prevents closing operation; 3 padlocks maximum Ø4...8mm/0.16...0.31".

STARTER ASSEMBLY ADAPTER PLATES

These accessories permit the assembly of starters, making slim and compact equipment that's easy and quick to install. The starter adapter plates install on DIN rail 35mm/1.38".

Certifications and compliance

Certifications obtained: cULus except SM1X17024..., SM1X17400..., SMX90... and 11LMM25PG16), EAC. Certifications pending: CCC for rigid connections and enclosures (maximum current enclosures for cULus: 25A). Compliant with standards: IEC/EN/BS 60947-1, IEC/EN/BS 60947-5-1, UL 60947-4-1, CSA C22.2 n° 60947-1, CSA C22.2 n° 60947-4-1.

① Complete with rubber membrane.



SM2X11...



SM2X12...

SM2X1311



SM2X14...

SM2X16...



SM2X18...

Order code	Characteristics	Qty per pkg	Wt
		n°	[kg]

Add-on auxiliary contacts.

SM2X1120	Front mount 2NO	10	0.020
SM2X1111	Front mount 1NO+1NC	10	0.020
SM2X1102	Front mount 2NC	10	0.020
SM2X1220	Side mount 2NO	2	0.040
SM2X1211	Side mount 1NO+1NC	10	0.040
SM2X1202	Side mount 2NC	2	0.040
SM2X1311	Side mount. Indicator contacts for thermal and magnetic tripping 1NO+1NC	2	0.040

Undervoltage trip releases.

SM2X14230	230VAC 50/60Hz	5	0.100
SM2X14400	400VAC 50/60Hz	5	0.100
SM2X14440	440VAC 50/60Hz	5	0.100

Shunt trip releases.

SM2X16024	24VAC 50/60Hz	5	0.100
SM2X16110	110VAC 50/60Hz	5	0.100
SM2X16230	230VAC 50/60Hz	5	0.100
SM2X16400	400VAC 50/60Hz	5	0.100
SM2X16440	440VAC 50/60Hz	5	0.100

Padlockable IP65 (4X) door coupling handle for SM2R... and SM3R....

SM2X18200R	Red/yellow complete with rod length 200mm/7.87"	1	0.115
SM2X18B200R	Black complete with rod with rod length 200mm/7.87"	1	0.115

Phase separation barriers set for SM3R...¹

SM3X9000R	For Type E as per UL60947-4-1	1	0.175
------------------	-------------------------------	---	-------

¹ Note: SM2R... motor protection circuit breakers are UL Type E without the need of phase separation barriers.

General and operational characteristics

ADD-ON AUXILIARY CONTACTS

- Insert on the top front or snap on the left side of the breaker
- Maximum combinations: 3 SM2X... blocks with 6 auxiliary contacts in total of which 1 front block and 2 side blocks²
- IEC conventional free air thermal current I_{th}: 10A (5A for SM2X11...)
- IEC rated insulation voltage U_i: 690V (250V for SM2X11...)
- UL/CSA and IEC/EN/BS 60947-5-1 designation: A600 – Q300 (B300 - R300 for SM1X11...)
- Conductor cross section minimum-maximum (1 or 2 wires): 0.75...2.5mm² or 18...14AWG
- Screw tightening tool: Pz 2
- Maximum tightening torque: 1Nm / 9lb.in
- Width of side-mount auxiliary contacts equal to 0.5 DIN 46880 modules.

UNDERVOLTAGE TRIP RELEASES

- Snap on to the right side of the breaker for motor protection
- Consumption in-rush/holding: 8.5/3VA
- Release voltage: 0.35...0.7U_n
- Operating limits: 0.85...1.1U_n
- Conductor cross section minimum-maximum (1 or 2 wires): 0.75...2.5mm² or 18...14AWG
- Screw tightening tool: Pz 2
- Maximum tightening torque: 1.2Nm / 10lb.in
- Width of side-mount undervoltage trip releases equal to 1 DIN 46880 module.

SHUNT TRIP RELEASES

- Snap on to the right side of the breaker
- In-rush consumption: 20VA
- Operating limits: 0.85...1.1U_n
- Conductor cross section minimum-maximum (1 or 2 wires): 0.75...2.5mm² or 18...14AWG
- Screw tightening tool: Pz 2
- Maximum tightening torque: 1.2Nm / 10lb.in
- Width of side-mount shunt trip releases equal to 1 standard DIN 46880 module.

PADLOCKABLE DOOR COUPLING HANDLE FOR SM2R and SM3R

- IEC degree of protection: IP65
- Degree of protection according to UL: Type 1, 2, 3R, 12, 12K, 4, 4X; external use
- Adjustable rod from 48 to 212mm (1.89" to 8.35")
- Ring-fixing in 22mm/0.87" hole.

Certifications and compliance

Certifications obtained: cULus, EAC.

Compliant with standards: IEC/EN/BS 60947-1, IEC/EN/BS 60947-5-1, UL 60947-4-1, CSA C22.2 n° 60947-1, CSA C22.2 n° 60947-4-1.

² Side blocks: n. 1 SM2X12... + SM2X1311.
It is not possible to mount 2 blocks SM2X12...

1 Motor protection circuit breakers

Add-on blocks and accessories for SM1...

Combinations

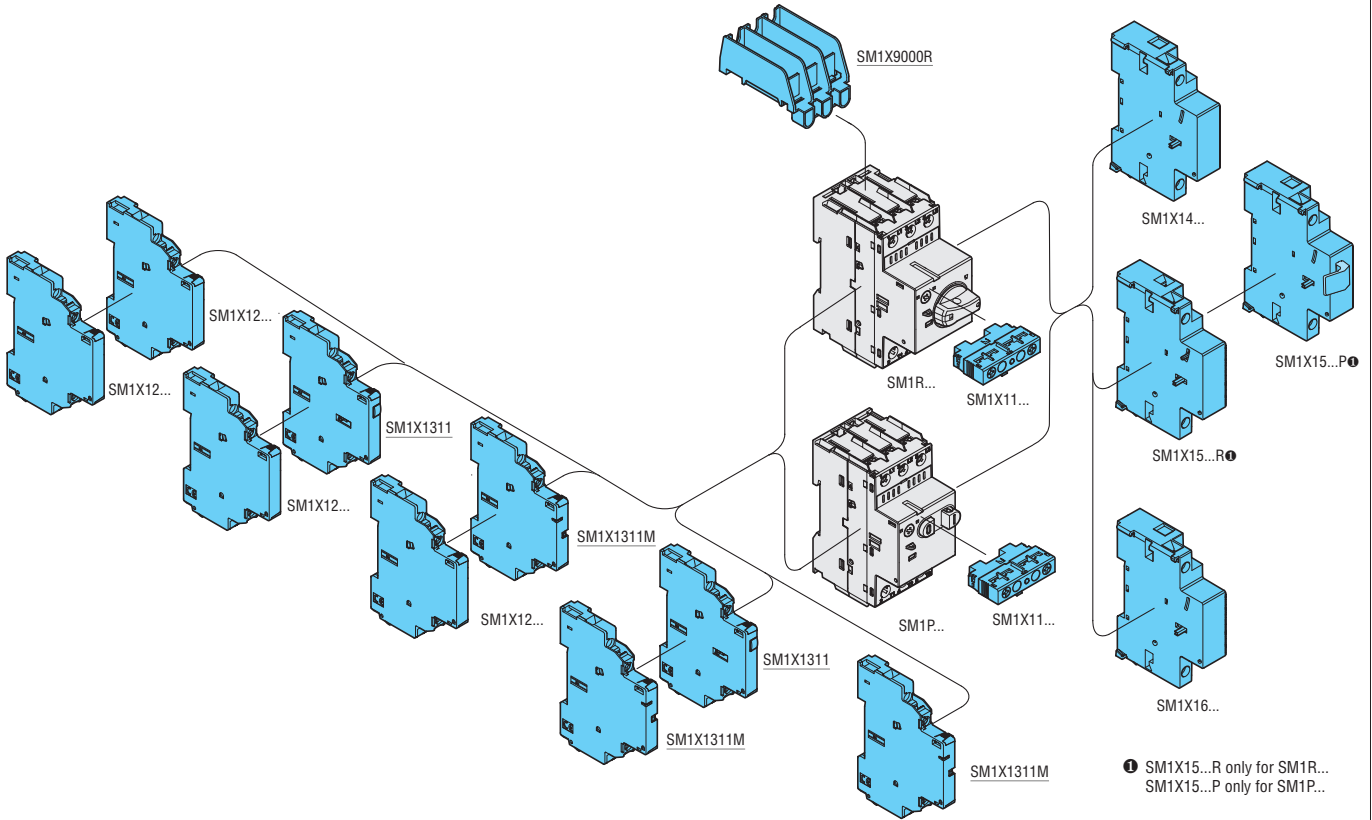

Three-phase connection busbars.

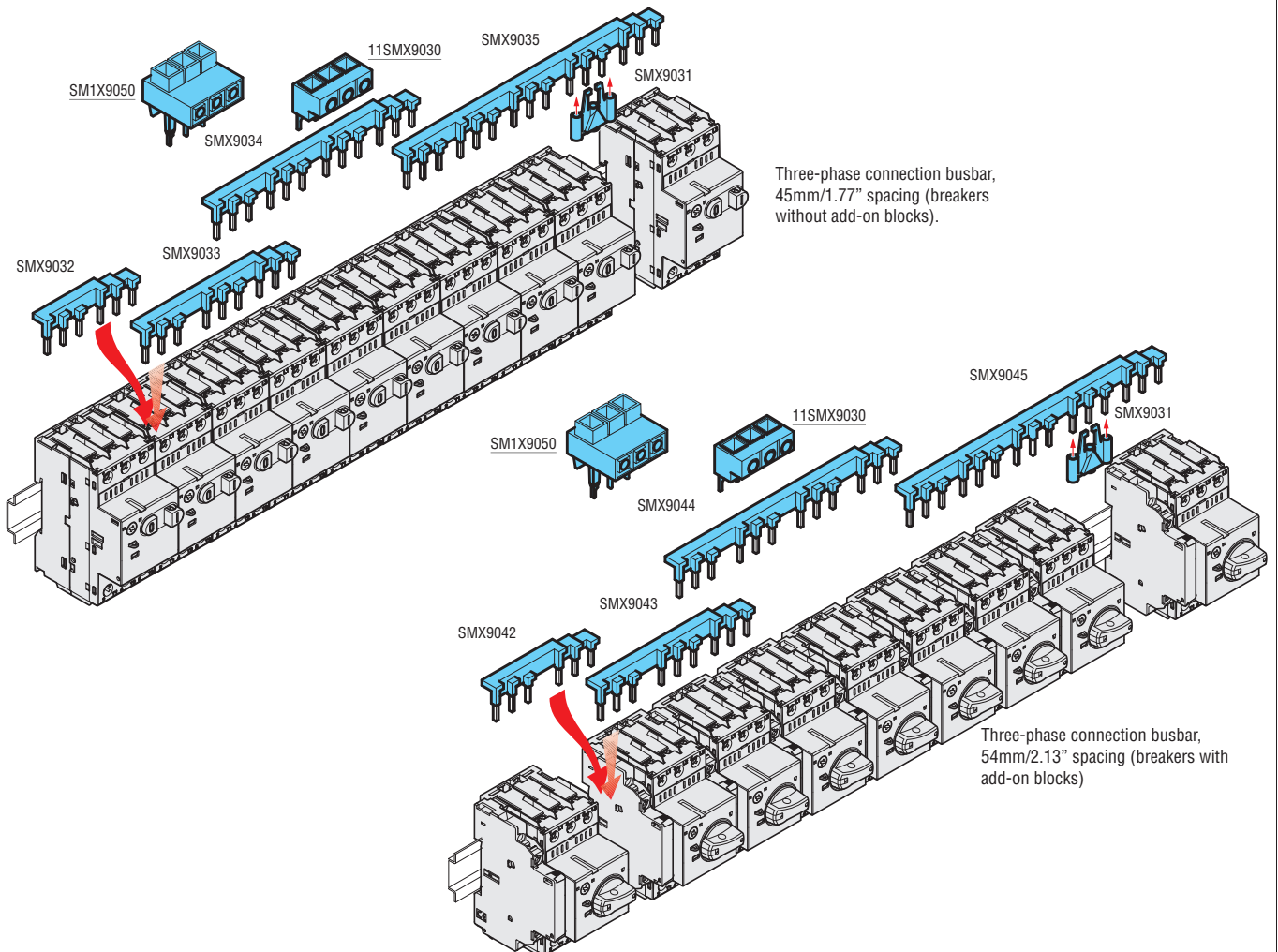

1 Motor protection circuit breakers

Add-on blocks and accessories for SM1...

Combinations

Rigid SM1P... breaker - contactor connections.

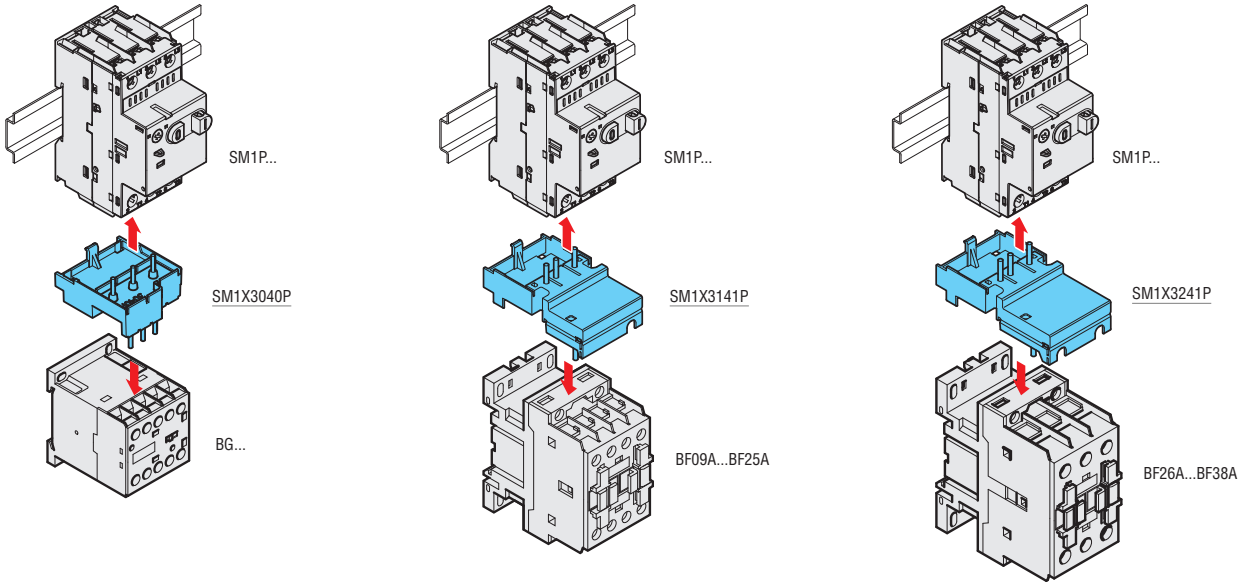

Rigid SM1R... breaker - contactor connections.

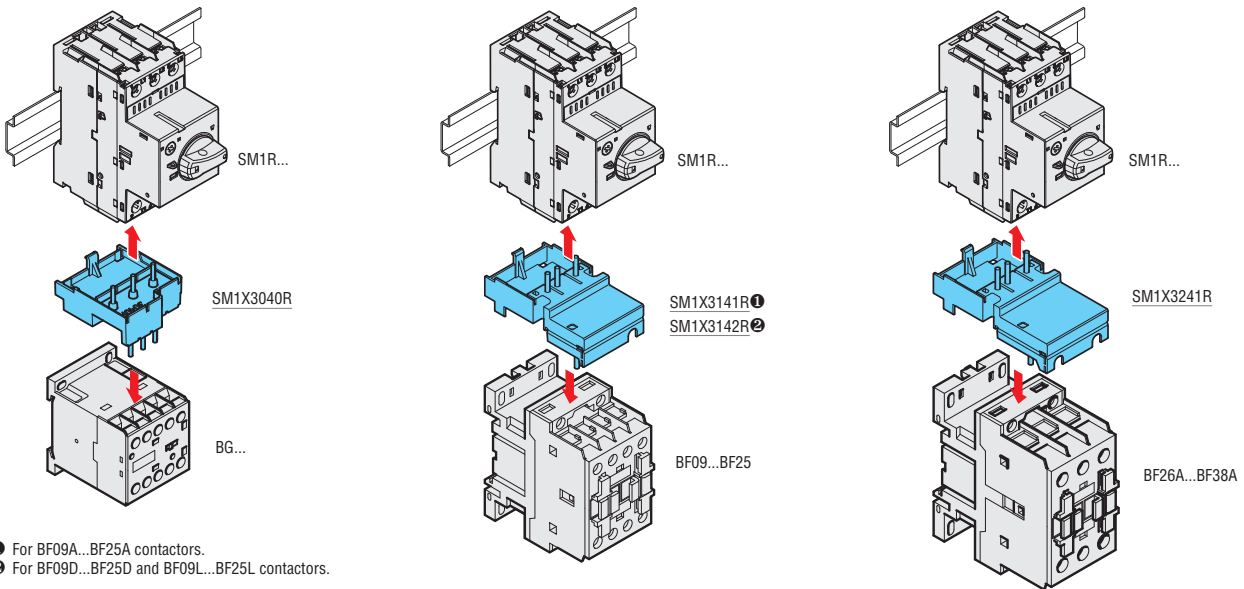

- ① For BF09A...BF25A contactors.
- ② For BF09D...BF25D and BF09L...BF25L contactors.

Padlockable door coupling handle.

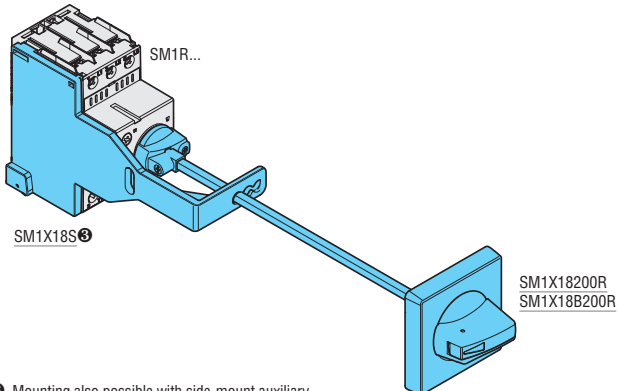

- ③ Mounting also possible with side-mount auxiliary contacts SM1X12... and SM1X13...

1 Motor protection circuit breakers

Add-on blocks and accessories for SM1...

Combinations

Surface mount enclosures for SM1P... Width 80mm.

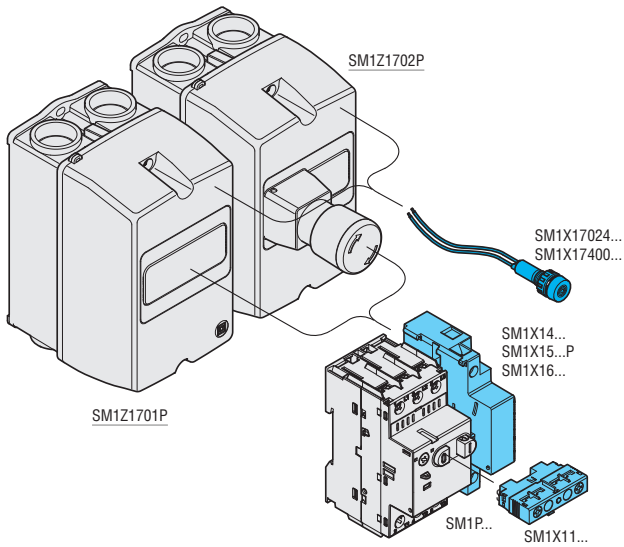

Surface mount enclosures for SM1P... Width 100mm.

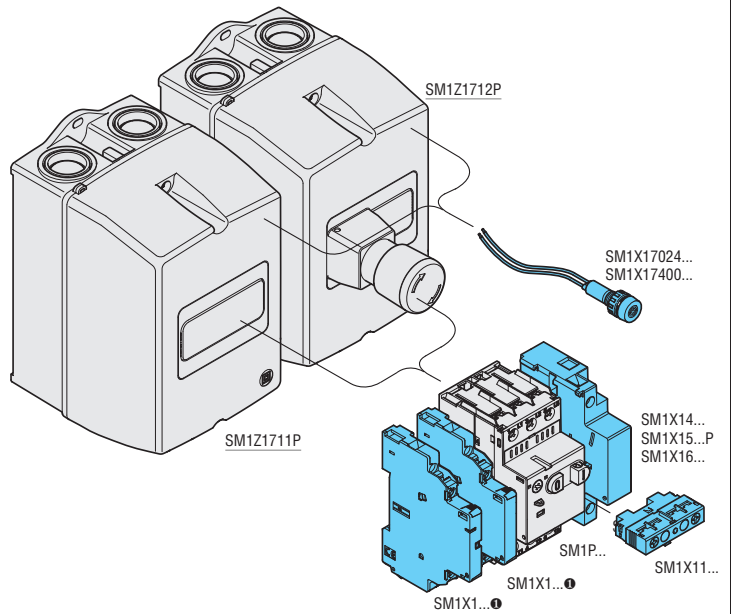

① Contacts for magnetic tripping indication SM1X1311M when mounted in SM1Z1711P and SM1Z1712P, can't be mounted alone, but shall be mounted in combination with SM1X12... on SM1X1311.

Flush mount enclosures for SM1P... Width 87mm/3.42".

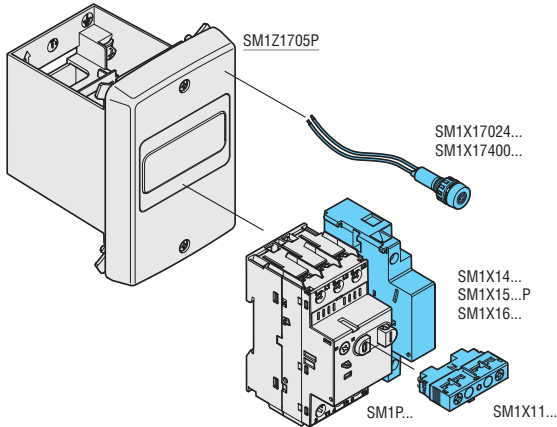

Surface mount enclosures for SM1R... Width 100mm/3.94".

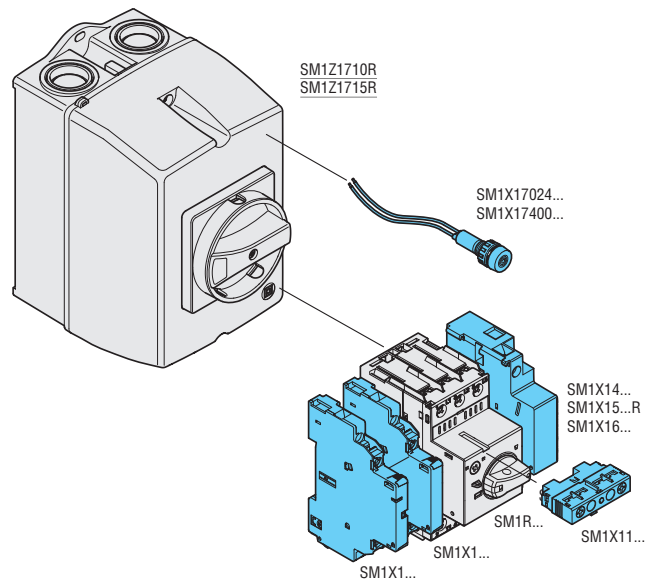

Flush mount enclosures for SM1R... width 87mm/3.42".

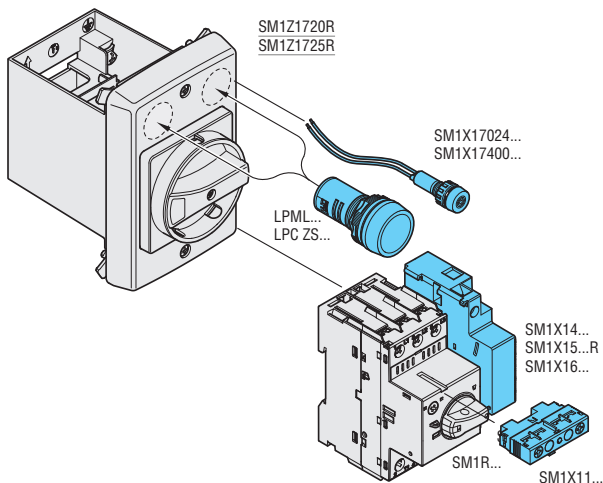

Combinations

Combinations of SM2... and SM3... motor protection circuit breakers

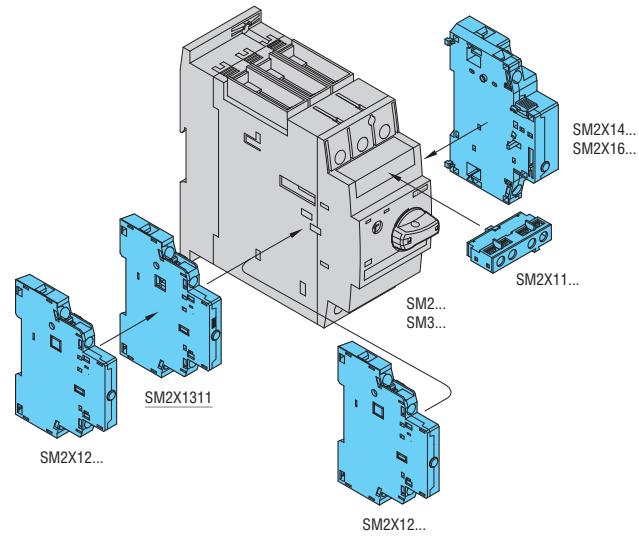

Padlockable door coupling handle.

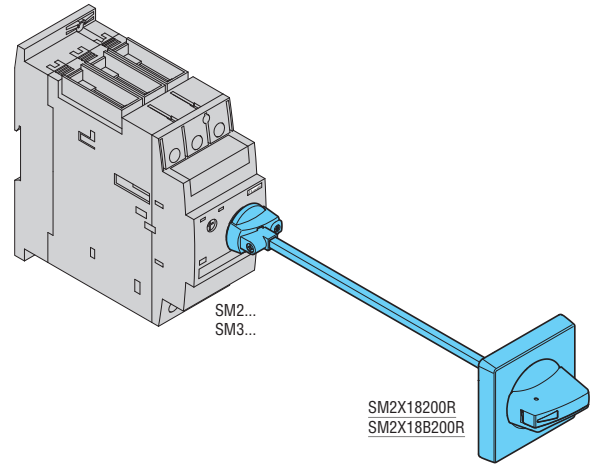

1 Motor protection circuit breakers

Dimensions [mm (in)]

INDEX

1

SM1P... with side-mount auxiliary contacts

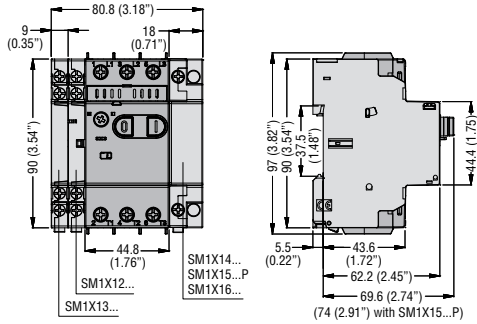

SM1R... with side-mount auxiliary contacts

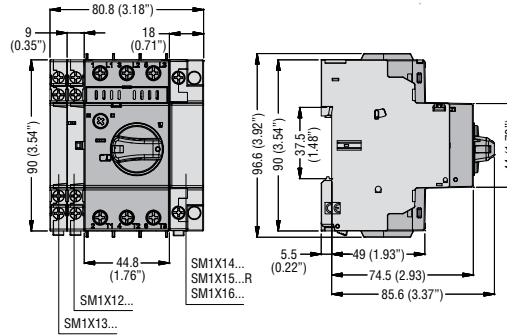

SM1P... with BG... mini-contacts and connection SM1X3040P

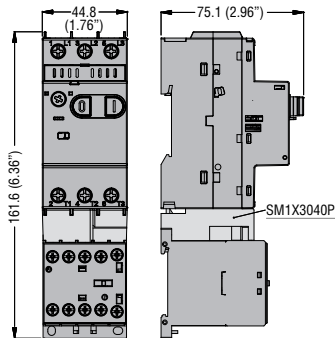

SM1P... with BF09 A...BF25 A... contactors and connection SM1X3141P

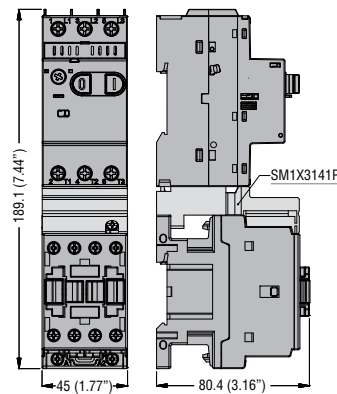

SM1P... with BF26 A...BF38 A... contactors and connection SM1X3241P

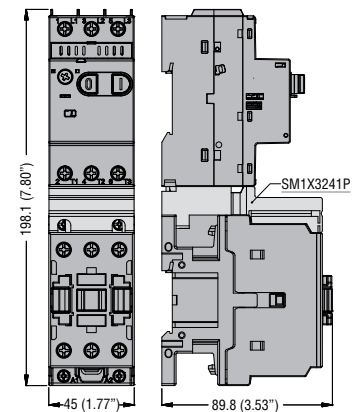

SM1R... with BG... mini-contacts and connection SM1X3040R

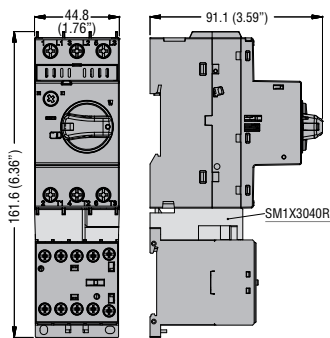

SM1R... with BF09 A...BF25 A... contactors and connection SM1X3141R

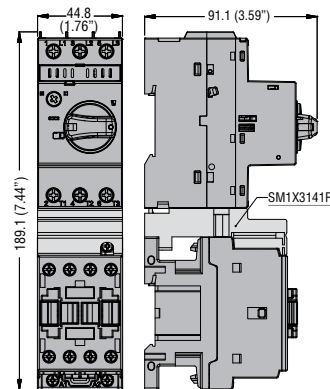

SM1R... with BF09 D...BF25 D... contactors BF09 L...BF25 L... and connection SM1X3142R

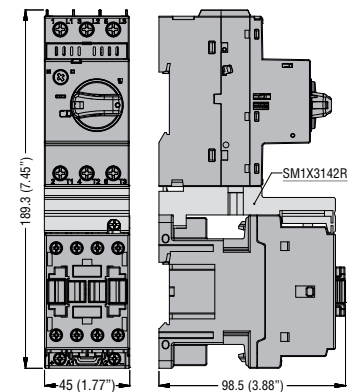

SM1R... with BF26 A...BF38 A... contactors and connection SM1X3241R

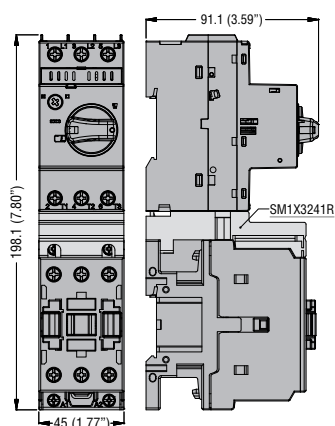

SM1R... padlockable door coupling handle SM1X18200R or SM1X188200R

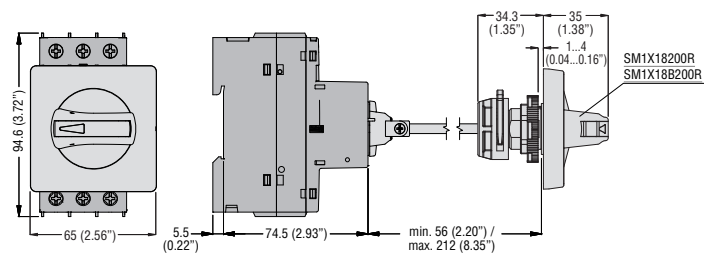

1 Motor protection circuit breakers

Dimensions [mm (in)]

These elements mounted with **SM1... breakers** without side-mount auxiliary contacts

These elements mounted with **SM1... breakers** with side-mount auxiliary contacts **SMX12... or SMX13 11**

SM1X9000R

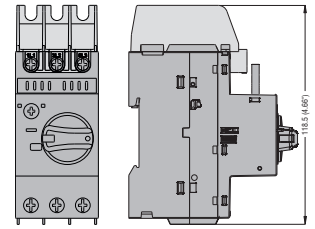
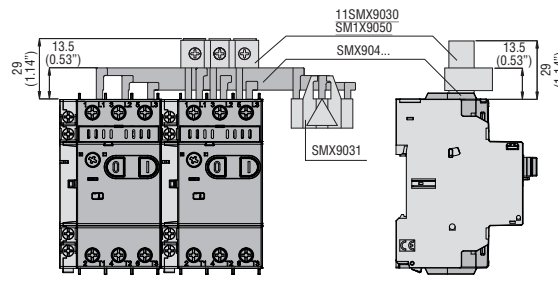
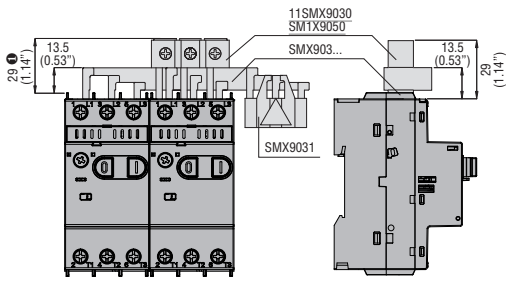

37mm (1.45") for SM1X9050

SMX9032 - SMX9033 - SMX9034 - SMX9035
Connection busbars – 45mm/1.77" spacing

SMX9042 - SMX9043 - SMX9044 - SMX9045
Connection busbars – 54mm/2.13" spacing

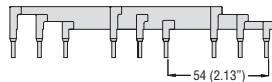
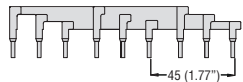

Enclosures **SM1Z1701P**

Enclosures **SM1Z1702P**

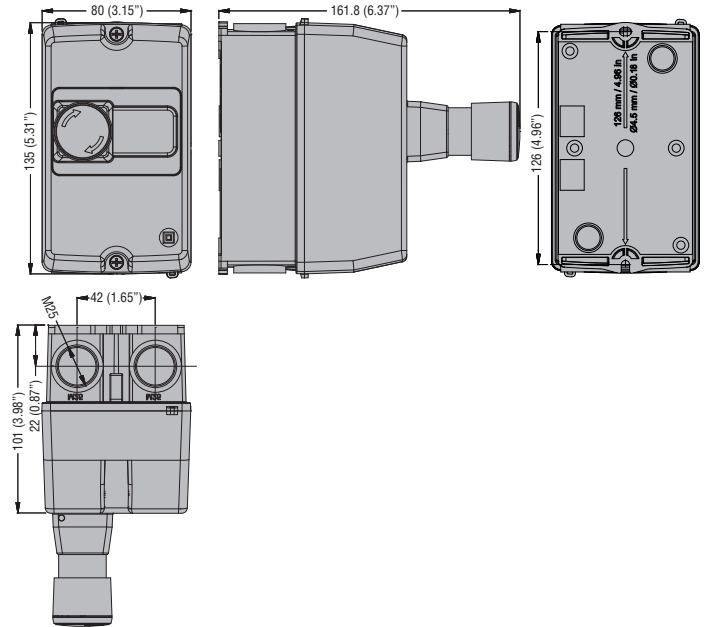
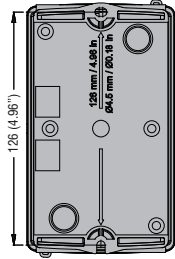
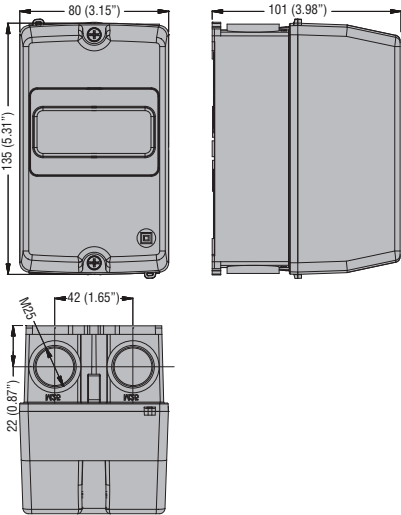

Enclosures **SM1Z1711P**

Enclosures **SM1Z1712P**

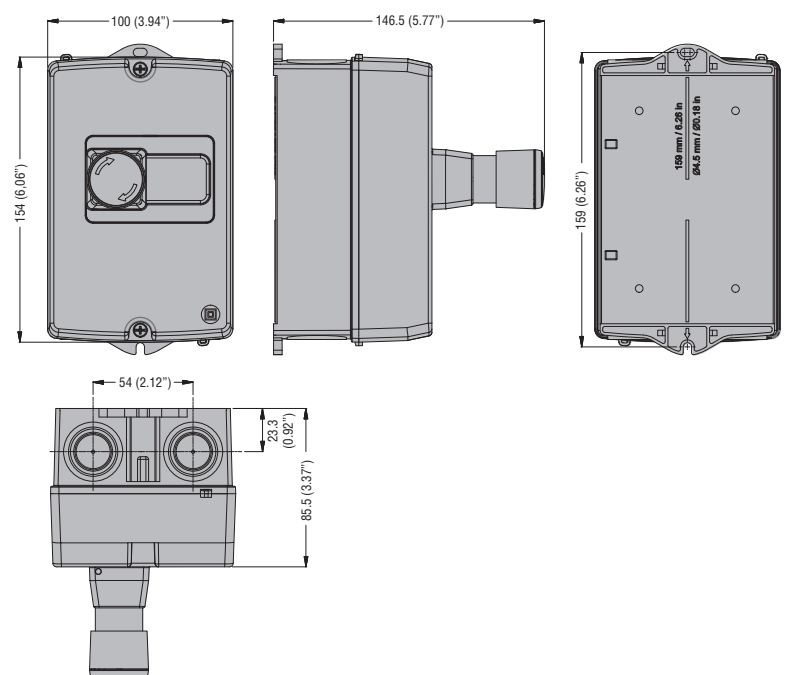
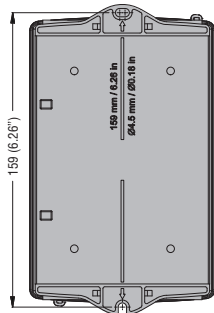
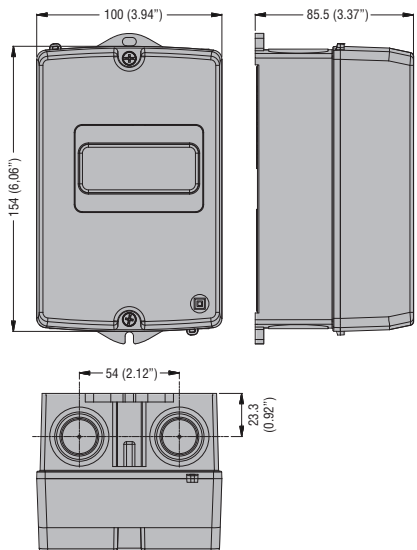

1 Motor protection circuit breakers

Dimensions [mm (in)]

Enclosures **SM1Z1705P**

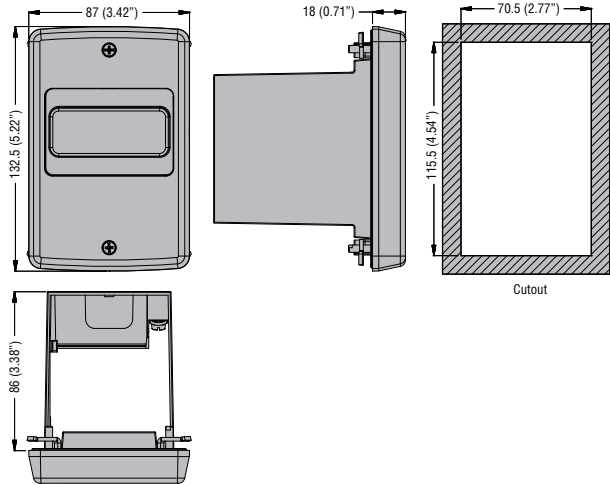

Enclosures **SM1Z1715R** and **SM1Z1710R**

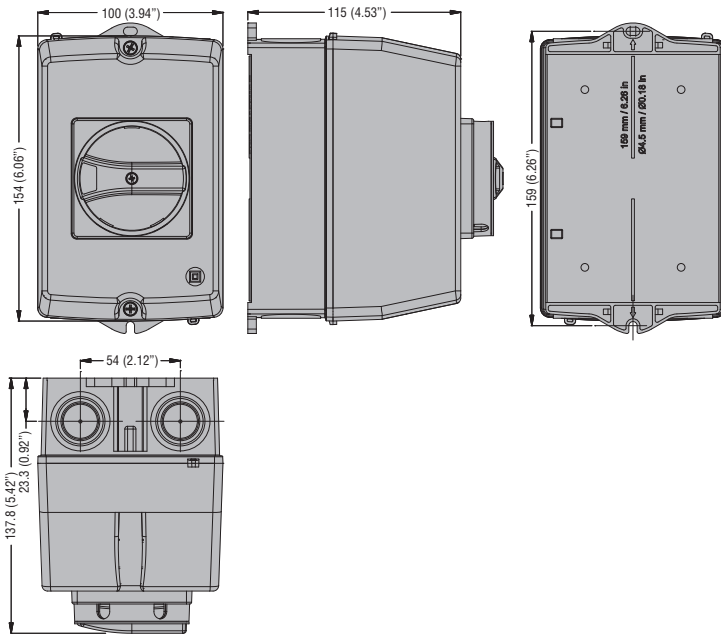

Enclosures **SM1Z1720R** and **SM1Z1725R**

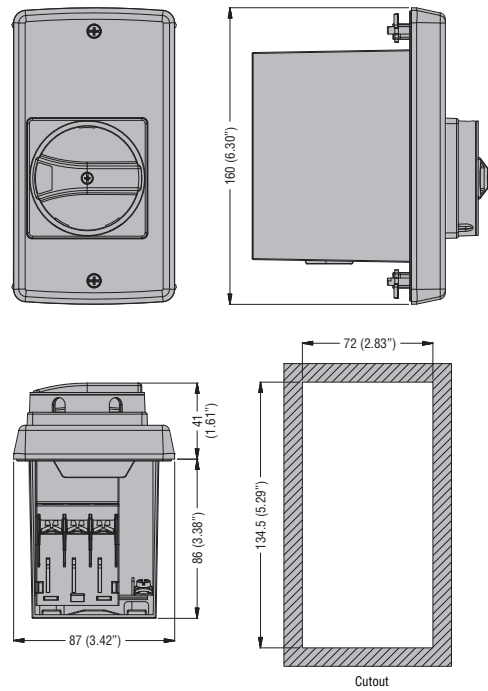

1 Motor protection circuit breakers

Dimensions [mm (in)]

SM2... with side-mount auxiliary contacts

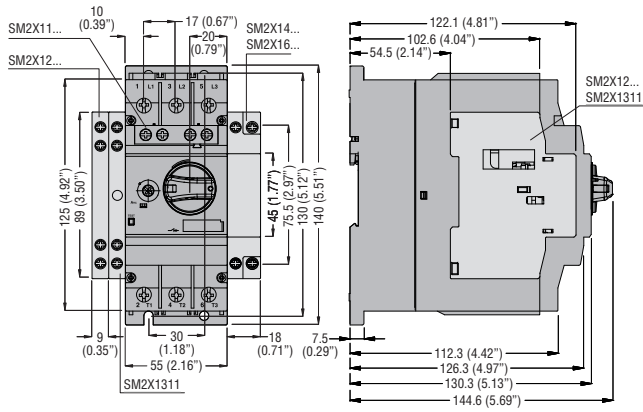

SM3... with side-mount auxiliary contacts

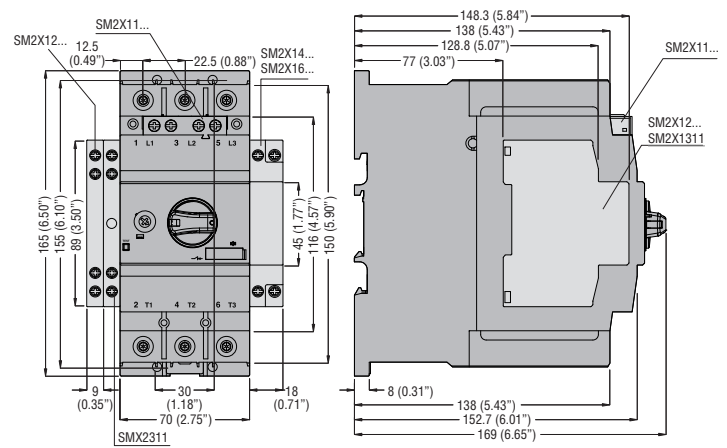

SM2... and SM3... padlockable door coupling handle SM2X18200R or SM2X18B200R

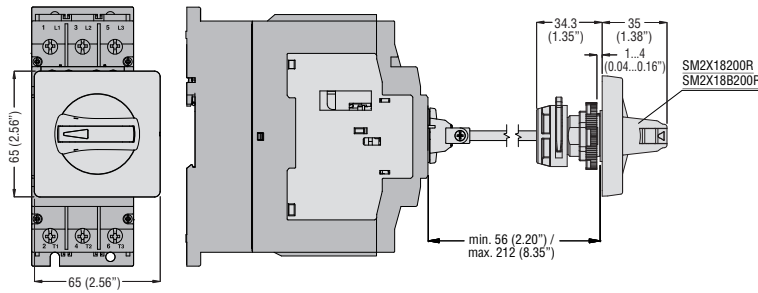

Wiring diagrams

MOTOR PROTECTION CIRCUIT BREAKERS

SM1P...

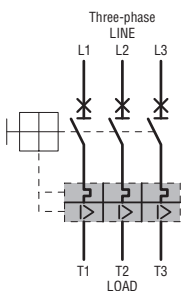

SM1R... - SM2R... - SM3R... - SM1RM... SM1RE...

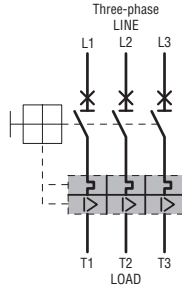
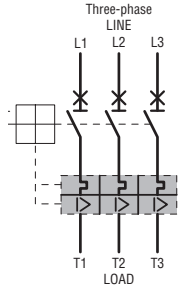

CIRCUIT BREAKERS

SM1PF...

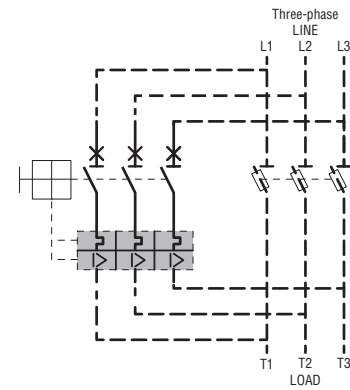

For all motor protection circuit breakers

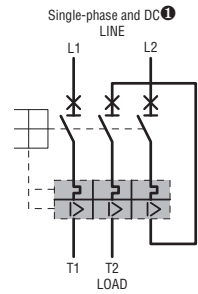

Consult our Technical support for DC use.

ADD-ON BLOCKS

For SM1... types

Front mount auxiliary contacts

SM1X1120 SM1X1111

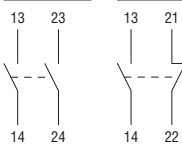

Side mount auxiliary contacts

SM1X1211 SM1X1220 SM1X1202

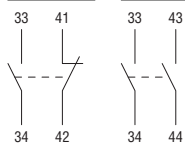

SM1X1311 SM1X1311M

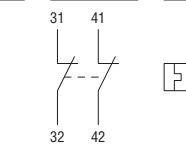

Side mount undervoltage trip releases

SM1X14... SM1X15...

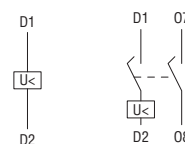

Side mount shunt trip release

SM1X16...

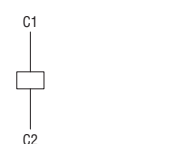

For SM2R... and SM3R... types

Front mount auxiliary contacts

SM2X1120 SM2X1111 SM2X1102

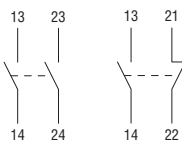

Side mount auxiliary contacts

SM2X1211 SM2X1220 SM2X1202 SM2X1311

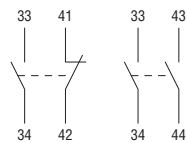

Side mount undervoltage trip release

SM2X14...

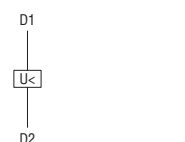

Side mount shunt trip release

SM2X16...

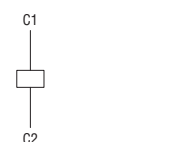

1 Motor protection circuit breakers

Technical characteristics

TYPE			SM1P...	SM1R...- SM1RM...	SM1RT...	SM2R...	SM3R...
Rated insulation voltage U_i	V		690			1000	
Rated impulse withstand voltage U_{imp}	kV		6				
Rated frequency	Hz		50/60Hz				
Maximum rated current	A		40	40	25	63	100
Number of adjustment ranges	No.		16	16	14	2	3
Total power dissipation at maximum current	W		2.1...18.3	2.1...18.3	2.1...10.2	6.1...21	5.4...18
Magnetic tripping	A		$13 \times I_n$ ①	$13 \times I_n$ ②	$20 \times I_n$ ③	$13 \times I_n$	$13 \times I_n$
Mechanical life	cycles		100,000	100,000	100,000	50,000	50,000
Electrical life (I_e max AC3)	cycles		100,000	100,000	100,000	25,000	25,000
Terminal tightening torque	Nm		2.5...3	2.5...3	2.5...3	3...4.5	4...6
	lb.in		22...26.5	22...26.5	22...26.5	36	53
	Tool		PH2	PH2	PH2	PZ2	Allen 4mm
Conductor section minimum and maximum (1 or 2 wires)	AWG	No.	16...8	16...8	16...8	18...3	10...1/0
	mm ²		1...10	1...10	0.75...25	10...50	
AMBIENT CONDITIONS							
Temperature	operating	°C	-20...+60④	-20...+60④	-20...+60④	-20...+70④	-20...+70④
	storage	°C	-50...+80	-50...+80	-50...+80	-50...+80	-50...+80
	compensation	°C	-20...+50	-20...+50	-20...+50	-5...+40	-5...+40
Maximum altitude	m		3000				
Mounting position			Any				
Fixing			On 35mm DIN rail or screw via accessory			On 35mm DIN rail or screw	

E.g. PH = Phillips; PZ = Pozidriv; Allen is metric type.

① SM1PF0020 has a single 0.2A thermal adjustment and magnetic tripping at $6 \times I_n$ (1.2A).

② $10 \times I_n$ max for 0.1...0.16A and 0.16...0.25A setting ranges.

③ $16 \times I_n$ max for 0.1...0.16A setting range.

④ When fitting more than one breaker side by side, without leaving space between each to consent free air circulation on the breaker sides, and have simultaneous operation, the thermal trip adjuster must be positioned at a value 15% higher than the rated motor current.

THERMAL TRIPPING CURVE (AVERAGE TIMES)

Three-phase balanced operation

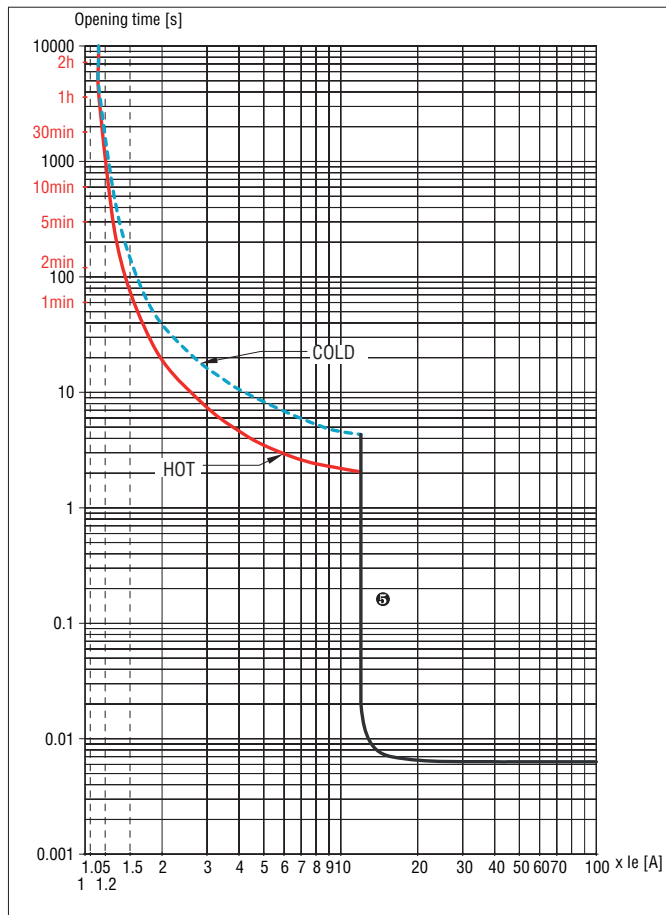

Two-phase operation (phase failure/single phasing)

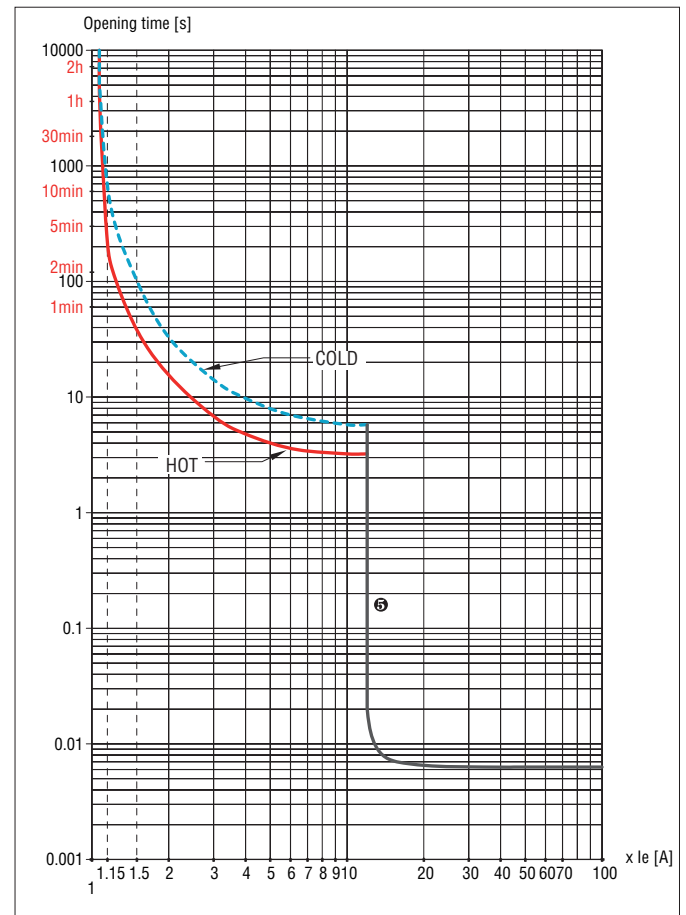

Tripping times can have a $\pm 20\%$ deviation with respect to the average tripping curve value above.

⑤ $20 \times I_e$ for SM1RT...



- Three-pole versions up to 630A in IEC AC3 duty
- Four-pole versions up to 1600A in IEC AC1 duty
- Versions for power factor correction up to 100kvar at 400VAC
- Four-pole versions with 2NO+2NC or 4NC main poles
- Versions for photovoltaic application
- Versions with AC, DC or AC/DC control
- Low-consumption versions with DC control circuit for control relays and 9-38A contactors in IEC AC3 duty
- Extensive choice of add-on blocks and accessories
- Certified by primary international authorities.

Contactors

Three-pole	2 - 6
Four-pole	2 - 10
Four-pole with 2NO and 2NC poles or 4NC poles	2 - 14
For Photovoltaic applications	2 - 15
For power factor correction	2 - 16
Control relays	2 - 17

Add-on blocks and accessories

For BG series mini-contactors	2 - 18
For BF series contactors	2 - 20
For B series contactors	2 - 30

Spare parts

AC coils for BF series contactors	2 - 32
AC/DC and DC coils for BF series contactors	2 - 33
AC/DC coils for B series contactors	2 - 34
Main contacts for BF series contactors	2 - 35
Main contacts and arc chutes for B series contactors	2 - 35

Dimensions	2 - 36
-------------------------	---------------

Wiring diagrams	2 - 51
------------------------------	---------------

Technical characteristics	2 - 56
--	---------------

SEC. - PAGE



Page 2-6

THREE-POLE CONTACTORS

- IEC Ith ratings in AC1 duty at $\leq 40^{\circ}\text{C}$: 16 to 1600A
- IEC Ie ratings in AC3 440V duty: 6 to 630A
- IEC Power ratings in AC3 400V duty: 2.2 to 335kW
- UL/CSA ratings: 3 to 500HP at 480V and 600V
- AC, DC, AC/DC and DC low-consumption coil.



Page 2-10

FOUR-POLE CONTACTORS

- IEC Ith ratings in AC1 duty at $\leq 40^{\circ}\text{C}$: 20 to 1600A
- IEC Power ratings in AC1 400V duty: 14 to 950kW
- UL/CSA general use: 16 to 1000A
- AC, DC, AC/DC and DC low-consumption coil.



Page 2-14

FOUR-POLE CONTACTORS WITH 2NO+2NC MAIN POWER POLES AND WITH 4 NC POLES

- IEC Ith ratings in AC1 duty at $\leq 40^{\circ}\text{C}$: 20 to 115A for type 2NO+2NC
- UL/CSA general use: 20 to 115A
- IEC Ith ratings in AC1 duty at $\leq 40^{\circ}\text{C}$: 25 to 40A
- UL/CSA general use: 20 to 55A for 4NC types
- AC, DC, AC/DC and DC low-consumption coil.



Page 2-15

CONTACTORS FOR PHOTOVOLTAIC APPLICATIONS

- Operational current up to 165A (DC1 600V at $\leq 55^{\circ}\text{C}$ with 4 NO poles in series) for photovoltaic applications.
- AC, and AC/DC coil.

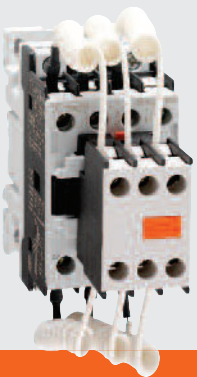

Page 2-16

CONTACTORS FOR POWER FACTOR CORRECTION

- With limiting resistors included
- IEC Power ratings at 400V: 7.5 to 100kvar
- UL/CSA ratings: 9 to 100kvar at 480V; 10 to 120kvar at 600V
- AC coil.



Page 2-17

CONTROL RELAYS

- AC, DC and DC low-consumption coil
- Screw or Faston termination
- 4, 8 or 11 auxiliary contact composition.



LOVATO Electric contactors are suitable for new motors with high IE3 efficiency values

THE IDEAL SOLUTION!



45mm WIDE CONTACTORS

Ratings up to 38A in AC3 (18.5kW) 400V 30HP 480V UL - merely 45mm wide: exceptional benefit for electric panel dimensions.

55mm WIDE CONTACTORS

Ratings up to 95A in AC3 (45kW) 400V / 60HP 480V UL - merely 55mm wide: exceptional benefit for electric panel dimensions.

75mm WIDE CONTACTORS

Ratings up to 150A in AC3 (75kW) 400V / 100HP 480V UL - merely 75mm wide: exceptional benefit for electric panel dimensions.

4-TERMINAL COIL

Connecting cables can be coupled to the coil both on the line and load ends of the contactor.

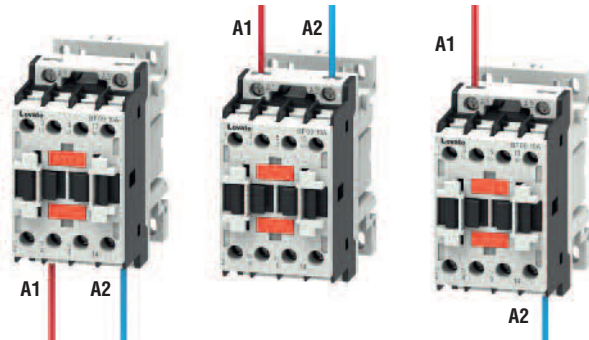

ELECTRONIC COIL

Contactors from 40 to 150A AC3 can be equipped with AC/DC electronic coil with wide operating range. Example: single 100 to 250V AC/DC coil.

BUILT-IN SURGE SUPPRESSOR

BF series contactors up to 150A AC3 with voltages in DC or AC/DC already have a built-in surge suppressor.

LOW-CONSUMPTION COILS

The BF...L contactors feature a 2.4W low consumption. This characteristic widely allows their direct control by PLC outputs.

COILS WITH WIDE OPERATING RANGE

BF...D contactors are equipped with a wide operating range coil and are particularly useful in applications subject to considerable voltage variations, such as in electric traction railway equipment.

RAILWAY APPLICATIONS



Thanks to the compliance with IEC 61373 (shock and vibration) and EN 45545 (fire behaviour), LOVATO Electric contactors are suitable for railway applications. Consult Technical support for detailed information; see contact details on inside front cover.

HOUSEHOLD AND COMMERCIAL APPLICATIONS



The plastic materials of the contactors comply with the EN 60335 standard typically applied in equipment for food industry and professional catering. Consult Technical support for detailed information; see contact details on inside front cover.

PHOTOVOLTAIC APPLICATIONS



LOVATO Electric contactors are suitable for use in the various sections of the photovoltaic systems. In particular, there are specific contactors for use up to 1000VDC.

● **35MM DIN RAIL MOUNTING AND FIXING**

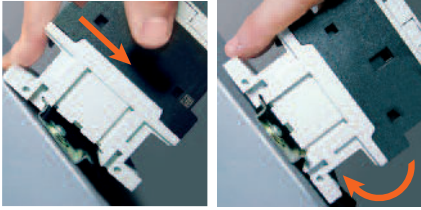

Contactors mounting on and removal from a 35mm DIN rail are tool-less operations and are done by simply applying pressure on the contactor.

● **RUBBER PAD INSERT TO PREVENT DIN RAIL SLIDING**

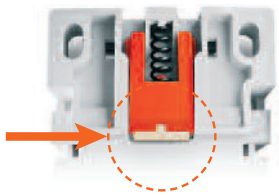

A rubber insert prevents the contactors from sliding on the 35mm DIN rail even when out of tolerance or mounted vertically.

● **SNAP-ON INSTALLATION**

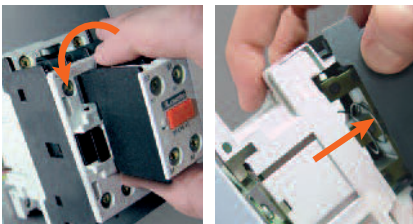

On the contactors, it's quick and easy to fit and remove auxiliary contacts and accessories, without using tools; the same applies to replacing the coil in the AC BF09...BF38 contactors.

● **EFFORTLESS THERMAL OVERLOAD RELAY LINK RF38, RF82 AND RF110 TYPES**

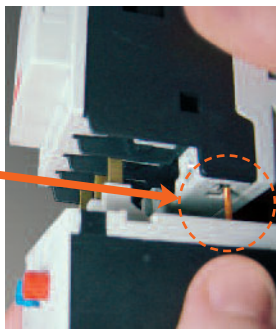

During the connection of the thermal overload relay to the contactor, its auxiliary contact is simultaneously linked to the contactor coil terminal rigid connector. The complete overload relay fixing is obtained with one single operation and without other connections.

● **RIGID CONNECTION KITS FOR FAST WIRING WITHOUT MISTAKES**

The assembly and wiring of electromechanical starters is extremely fast and reliable. Versatile electrical and mechanical connecting systems provide easy and foolproof assembly of compact starters and changeovers.

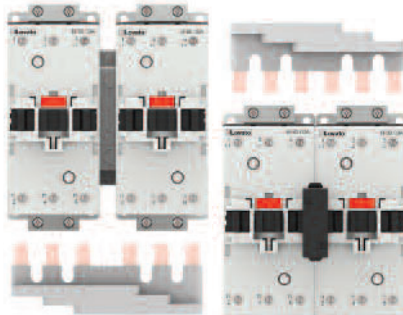

Changeover

Reversing starter

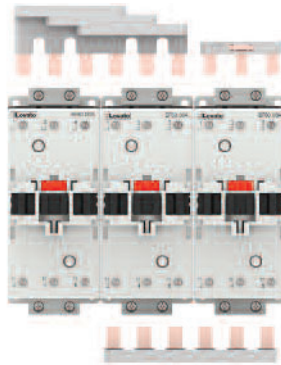

Star-delta starter

● **BREAKER-CONTACTOR CONNECTIONS**

The rigid connections between breaker and contactor allow complete compact starters to be created easily, quickly and with less space used in the panel. It is fitted on a single DIN rail.



● **IP20 CONNECTION SECURITY**

For BF09...BF38 contactors, the easy access and space for the terminals is combined with IP20 protection, preventing accidental contact with live parts.

● **IP20 ACCESSORY FOR CONTACTORS FROM 40A TO 150A AC3**

IP20 protection can be obtained by adding a simple accessory.



● **SIDE ADD-ON FOURTH POLE**

For the 45A to 165A AC1 ratings, a side-mount fourth power pole can be snapped on the three-pole contactor. This solution permits the optimisation of inventory.



● **MECHANICAL INTERLOCK**

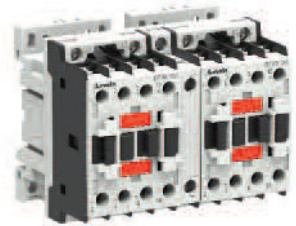

Various versions of mechanical interlock are available. One type can be integrated in the contactors from 9 to 38A AC3 without increasing the overall dimensions. They may have built-in contacts to also make the electrical interlock. The mounting position can be on the side or on the front of the contactors.

● **TERMINAL ADAPTABILITY**

Terminals are suitable for every type of cable: flexible, rigid, according to AWG standards and interlocked with any type of cable terminal. For BF09...BF38 contactors, a single type of screwdriver tightens the screws for the power contacts, auxiliary contacts and coil.

● **DOUBLE LUG TERMINALS**

40 to 150A AC3 contactors are equipped with double lug terminals for easy, functional access for power cables. It is extremely simple to create star-delta starters, reversing switches, changeovers and arrange parallel supply for several contactors.



2 Contactors

Contactors BF160...BF230

INNOVATION IS CONTINUING....



- **AC/DC COIL WITH ELECTRONIC CONTROL.**
 - Wide operating range: for example one single coil to cover 100...250VAC/DC range.
 - Low consumption during in-rush and in service
 - No chattering in the event of irregular voltage
 - Built-in surge suppressor filter.

- **COMPACT DIMENSIONS**
 - Three-pole contactors: 105mm width for currents up to 230A AC3 - 350A AC1
 - Four-pole contactors: 140mm width for currents up to 350A AC1
 - Width identical with moulded-case circuit breakers of equal current.

- **CONTACT STATUS FRONT VIEW**
A front mechanical indicator allows to easily identify the status of the contacts.

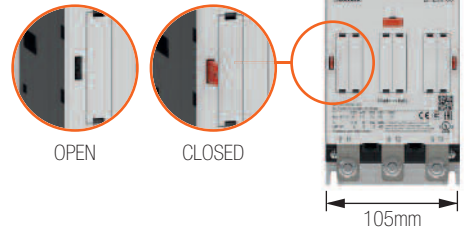

- **HIGH POWER TERMINALS FOR EASY AND SAFE WIRING**
High terminals to ensure a safe isolation distance from the panel in case of wiring with double terminals or bars for parallel or changeover.

- **SIDE-MOUNT AUXILIARY CONTACTS**
Useful in the event that the panel depth may be critical.

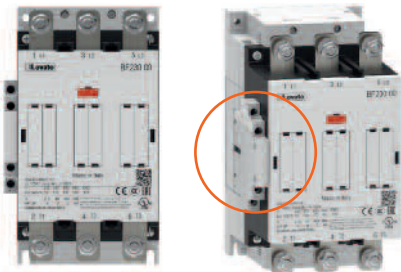

- **FRONT-MOUNT AUXILIARY CONTACTS**
Up to 6 NO or NC auxiliary contacts, with screw terminals, can be mounted without side dimensions increasing.

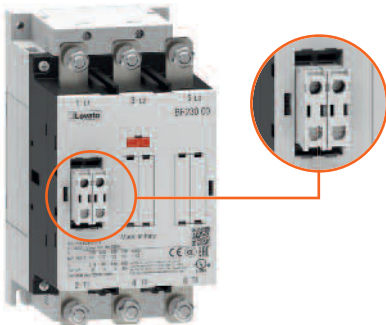

- **REVERSIBLE COIL TERMINALS BLOCK**
Easy coil terminal reversing upstream - downstream for easy wiring.

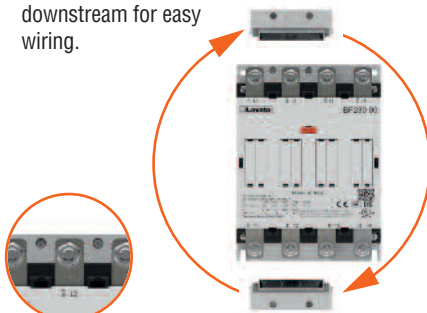

The coil terminals are easily accessible with a screwdriver as they are between the power terminals.

- **HORIZONTAL AND VERTICAL INTERLOCK**
Horizontal interlock with concealed mounting does not increase the dimensions.

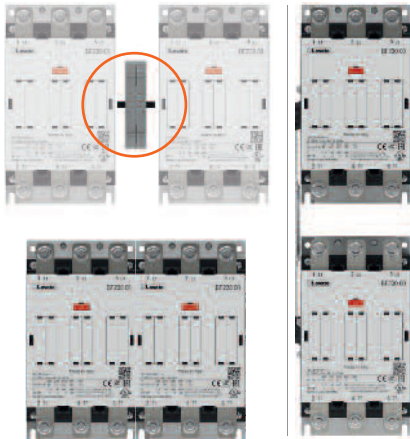

- **POWER TERMINAL PROTECTIONS PHASE BARRIERS.**
They guarantee the separation and protection of the power terminals and adjacent phases separation.



- **TERMINAL ENLARGEMENT**
They extend the pitch of the terminals from 35mm to 45mm to allow an easy wiring of standard flange lugs for cross-sectional cables of 185mm².



- **CAPTIVE NUT**
Accessory that allows even easier wiring of the terminals using a single wrench.

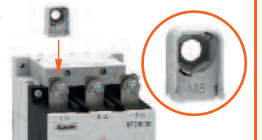

- **EASY COIL AND POWER CONTACTS REPLACEMENT**

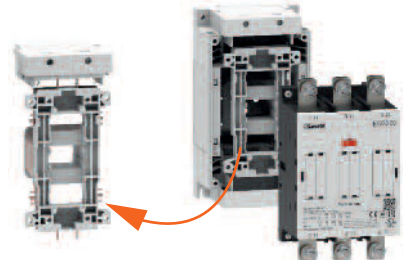

BG series mini-contactors



- AC and DC versions of same size
- Quick connect - snap on accessory mounting
- Distinct contact status indication
- Up to four auxiliary contacts can be mounted
- Mechanical interlock only 5mm depth
- Three-pole mini-contactors, 6 to 12A IEC AC3 duty / 3 to 7.5HP 480V - 3 to 10HP 600V UL/CSA
- Four-pole mini-contactors, 20A IEC AC1 duty
- Versions with 2NO+2NC main power poles
- Highly conductive auxiliary contacts with four contact points
- Coils with AC or DC supply
- Low-consumption DC versions
- Screw, faston and rear PCB solder pin termination.

	3 poles			4 poles		
	le (AC3)	AC	DC	lth (AC1)	AC	DC
BG06	6A	●	●	—	—	—
BG09	9A	●	●	20A	●	●
BGF09	9A	●	●	20A	●	●
BGP09	9A	●	●	20A	●	●
BG12	12A	●	●	—	—	—

BF series contactors



- Quick connect - snap on accessory mounting
- Distinct contact status indication
- Up to eight auxiliary contacts can be mounted
- Mechanical interlock without overall dimensions increasing
- Three-pole contactors, 9 to 230A IEC AC3 duty / 5 to 150HP 480V - 7.5 to 200HP 600V UL/CSA
- Four-pole contactors, 25 to 350A in AC1 duty
- Power factor correction contactors, 7.5 to 100kvar at 400V IEC / 9 to 110kvar at 480V UL/CSA
- Types with 2NO+2NC or 4NC main power poles
- Types for photovoltaic applications
- Highly conductive auxiliary contacts
- Coils with AC or DC supply
- Wide-range coils with electronic control for contactors from 40 to 230A AC3
- Low-consumption versions for control relays and 9-38A contactors in IEC AC3 duty.
- Screw terminals.

	le (AC3)	3 poles with coil type:			
		AC	DC	DC ^①	AC/DC ^②
BF09	9A	●	●	●	—
BF12	12A	●	●	●	—
BF18	18A	●	●	●	—
BF25	25A	●	●	●	—
BF26	26A	●	●	●	—
BF32	32A	●	●	●	—
BF38	38A	●	●	●	—
BF40	40A	●	—	—	●
BF50	50A	●	—	—	●
BF65	65A	●	—	—	●
BF80	80A	●	—	—	●
BF94	95A	●	—	—	●
BF95	95A	●	—	—	●
BF115	115A	●	—	—	●
BF150	150A	●	—	—	●
BF160	160A	—	—	—	●
BF195	195A	—	—	—	●
BF230	230A	—	—	—	●

	lth (AC1)	4 poles with coil type:			
		AC	DC	DC ^①	AC/DC ^②
BF09	25A	●	●	●	—
BF12	28A	●	—	—	—
BF18	32A	●	●	●	—
BF26	45A	●	●	●	—
BF38	56A	●	●	●	—
BF40	70A	●	—	—	—
BF50	90A	●	—	—	—
BF65	100A	●	—	—	●
BF80	115A	●	—	—	●
BF95	140A	●	—	—	●
BF115	160A	●	—	—	●
BF150	165A	●	—	—	●
BF160	250A	—	—	—	●
BF195	275A	—	—	—	●
BF230	350A	—	—	—	●

① Low-consumption version.
② Wide-range coil with electronic control.

B series contactors



- 3 frame sizes offering 8 different contactors
- Coil operates indifferently on AC or DC supply voltage
- Coil with low in-rush and holding
- Coil removable without disconnecting power wiring
- Red indicator when contactor is energised
- Safety feature prevents contactor to be energised without arc chute in place and locked
- Convertible auxiliary contact block (2NO + 1NC or 1NO + 2NC), maximum of 4 blocks per contactor for a total of 12 contacts
- Contactor terminals with bolt, washer and nut
- Simple horizontal or vertical interlock
- Three-pole contactors, 265A to 630A IEC AC3 duty
- Four-pole contactors, 350A to 1600A IEC AC1 duty
- 100 to 500HP 600V UL/CSA
- Coils with AC/DC supply
- Screw termination.

	3 poles			4 poles		
	le (AC3)	AC	AC/DC	lth (AC1)	AC	AC/DC
B250	265A	—	●	350A	—	●
B310	320A	—	●	450A	—	●
B400	420A	—	●	550A	—	●
B500	520A	—	●	700A	—	●
B630	630A	—	●	800A	—	●
B6301000	①	—	●	1000A	—	●
B1250	①	●	—	1250A	●	—
B1600	①	●	—	1600A	●	—

① For AC1 / general use duty only.

2 Contactors

Three-pole contactors with AC control circuit



INDEX



new



BG06A...BG12A

BF09A...BF25A

BF26A...BF38A

BF40A...BF94A

BF95A...BF150A

BF160E...BF230 E

B250...B400

Three-phase motor control in AC3 duty

UL/CSA details

Order code	IEC operating current				Maximum IEC power at ≤55°C (AC3)								Maximum UL/CSA horsepower ratings					
	I _{th} (AC1)			I _e (AC3)	230V	400V	415V	440V	500V	690V	1000V	Single phase		Three phase				
AC coil	≤40°C	≤55°C	≤70°C	≤440V at ≤55°C								120V	240V	200V	240V	480V	600V	
[A]	[A]	[A]	[A]	[A]	[kW]	[kW]	[kW]	[kW]	[kW]	[kW]	[kW]	[HP]	[HP]	[HP]	[HP]	[HP]	[HP]	
11BG0601A①	16	14	12	6	1.5	2.2	2.4	2.5	3	3	—	1/3	1	1½	2	3	3	
11BG0610A①																		
11BG0901A①	20	18	15	9	2.2	4	4.3	4.5	5	5	—	1/2	1½	2	3	5	5	
11BG0910A①																		
11BGF0901A①	20	18	15	9	2.2	4	4.3	4.5	5	5	—	1/2	1½	2	3	5	5	
11BGF0910A①																		
11BGP0901A①	20	18	15	9	2.2	4	4.3	4.5	5	—	—	1/2	1½	2	3	5	—	
11BGP0910A①																		
11BG1201A①②	20	18	15	12	3.2	5.7	6.2	5.5	5	5	—	1/2	1½	3	3	7½	10	
11BG1210A①②																		
BF0901A①②	25	20	18	9	2.2	4.2	4.5	4.8	5.5	7.5	—	¾	2	3	3	5	7½	
BF0910A①②																		
BF1201A①②	28	23	20	12	3.2	5.7	6.2	6.2	7.5	10	—	1	2	5	5	7½	10	
BF1210A①②																		
BF1801A①②	32	26	23	18	4	7.5	9	9	10	10	—	1	3	5	5	10	15	
BF1810A①②																		
BF2501A①	32	26	23	25	7	12.5	13.4	13.4	15	11	—	2	3	7½	7½	15	15	
BF2510A①																		
BF2600A①②	45	36	32	26	7.3	13	14	14	15.6	18.5	—	2	5	7½	7½	15	20	
BF3200A①②	56	45	40	32	8.8	16	17	17	20	22	—	3	7½	10	10	20	25	
BF3800A①	56 (60④)	45 (48④)	40 (42④)	38	11	18.5	18.5	18.5	20	22	—	3	7½	10	15	30	30	
BF4000A①	70	60	50	40	11	18.5	22	22	22	30	18.5	3	7½	10	15	30	40	
BF5000A①②	90	75	65	50	15	22	30	30	30	37	22	5	10	15	20	40	40	
BF6500A①②	100	80	70	65	18.5	30	37	37	37	45	30	—	—	20	25	50	60	
BF8000A①②	115	95	80	80	22	45	45	45	55	55	37	—	—	25	30	60	75	
BF9400A①	115	95	80	95	30	55	55	55	55	55	37	—	—	25	30	60	75	
BF9500A①	140	115	100	95	30	55	55	55	75	90	45	—	—	30	30	60	75	
BF11500A①	160	130	115	115	37	55	55	55	75	110	55	—	—	40	40	75	100	
BF15000A①	165	135	118	150	45	75	75	75	90	110	55	—	—	50	50	100	125	
BF16000E②	250	210	180	160	45	75	90	90	110	132	75	—	—	50	60	125	150	
BF19500E②	275	230	200	195	55	90	110	110	132	160	90	—	—	60	75	150	150	
BF23000E②	350	290	250	230	55	110	110	132	132	160	110	—	—	75	75	150	200	
11B25000E②	350	300	250	265	83	140	155	164	176	212	156	—	—	75	100	200	250	
11B31000E②	450	370	300	320	100	170	188	200	213	256	180	—	—	100	125	250	300	
11B40000E②	550	430	360	420	130	225	247	263	271	352	208	—	—	125	150	350	400	
11B50000E②	700	550	500	520	156	290	306	328	367	416	312	—	—	150①	200①	400①	450①	
11B63000E②	800	640	540	630	198	355	368	368	368	440	368	—	—	200①	250①	500①	500①	
11B630100000E②	1000	850	700	—	For AC1/Resistive duty only. see page 2-8.								—	—	—	—	—	—
11B125024E②	1250	1050	880	—	For AC1/Resistive duty only. see page 2-8.								No UL	—	—	—	—	—
11B160024E②	1600	1360	1120	—	For AC1/Resistive duty only. see page 2-8.								No UL	—	—	—	—	—

- ① Complete order code with coil voltage digit or with voltage digit followed by 60 (if 60Hz). Standard voltages are as follows:
 - AC 50/60Hz 024 / 048 / 110 / 230 / 400V
 - AC 60Hz 024 60 / 048 60 / 120 60 / 220 60 / 230 60 / 460 60 / 575 60 (V).
 Example: 11BG0610A230 for mini-contactor BG06, three poles, with one NO contact and 230VAC 50/60Hz coil.
 11BG0610A460 60 for mini-contactor BG06 with one NO contact and 460VAC 60Hz coil.
- ② The coil of the contactor can be powered indifferently in AC or DC. Complete the order code only with the digit of the coil voltage. Standard voltages are:
 - AC/DC 24 / 48 / 60 / 110-125 (indicate 110) / 220-240 (indicate 220) / 380-415 (indicate 380) / 440-480V (indicate 440).
 Example: 11B25000110 for contactor B250, three poles, without auxiliary contacts and with 110-125VAC/DC coil.
The 24VAC/DC voltage is not possible for B500...B6301000 contactors.
 Other voltages available on request.

- ③ If predisposed for mechanical latch (G495), the order code becomes 11B...SL00 ②. If already fitted with mechanical latch (G495), the order code becomes 11B...L00 ② ④.
- ④ Indicate rated voltage of the mechanical latch, preceded by the letter C if in DC. Available voltages are:
 - AC 50/60Hz 48 / 110-125 indicate 110 / 220-240 indicate 220 / 380-415V indicate 380
 - DC 48 / 110-125 indicate 110 / 220-240V indicate 220.
 Example: 11B250L0010220 for contactor B250 without auxiliary contacts, with 110-125VAC/DC coil and mechanical latch powered at 220-240VAC.
- ⑤ G495 mechanical latch cannot be mounted.
- ⑥ Complete the order code with the digit of the coil voltage. For 110-125VAC (50/60Hz) indicate 110 or 220-240VAC (50/60Hz) indicate 220.
 Example: 11B125024110 for contactor B1250, three poles, with 2NO+4NC auxiliary contacts and 110-125VAC 50/60Hz coil.
- ⑦ Maximum voltage is limited at 300V for UL. For certified type up to 600V, consult Technical support for information; see contact details on inside front cover.
- ⑧ For voltages 024 / 230 / 400VAC 50-60Hz: 10 pieces/package.
 For all other voltages: 1 piece/package.
- ⑨ Highly conductive auxiliary contact.

2 Contactors

Three-pole contactors with AC control circuit

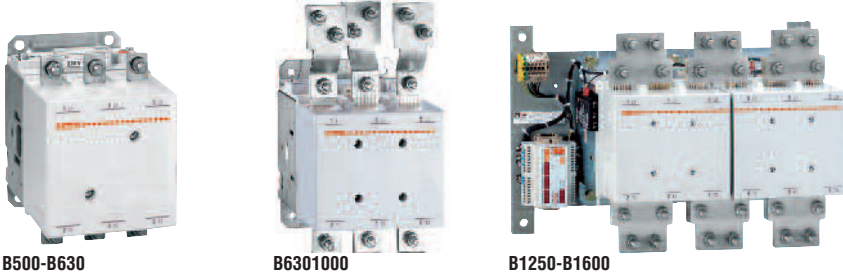

B500-B630

B6301000

B1250-B1600

UL/CSA General (purpose) use	UL/CSA Short-circuit protection fuse, 600V ¹				Type of terminal	Incorporated auxiliary contacts	Qty per pkg	Wt
	High fault		Standard fault					
	Short circuit current	Fuse	Short circuit current	Fuse				
[A]	[kA]	[A]	[kA]	[A]	NO NC	n°	[kg]	
16	100	30 (J)	5	30	Clamp-screw	— 1 ¹	10	0.180
						1 ¹ —	10	0.180
20	100	30 (J)	5	30	Clamp-screw	— 1 ¹	10	0.180
						1 ¹ —	10	0.180
20	100	30 (J)	5	30	Faston	— 1 ¹	10	0.180
						1 ¹ —	10	0.180
20	100	30 (J)	5	30	Rear PCB solder pin	— 1 ¹	10	0.197
						1 ¹ —	10	0.197
20	100	30 (J)	5	30	Clamp-screw	— 1 ¹	10	0.180
						1 ¹ —	10	0.180
25	100	30 (J)	5	60	Clamp-screw	— 1 ¹	1	0.367
						1 ¹ —	1	0.367
28	100	30 (J)	5	70	Clamp-screw	— 1 ¹	1	0.367
						1 ¹ —	1	0.367
32	100	60 (J)	5	80	Clamp-screw	— 1 ¹	1	0.367
						1 ¹ —	1	0.367
32	100	60 (J)	5	100	Clamp-screw	— 1 ¹	1	0.367
						1 ¹ —	1	0.367
45	100	100 (J)	5	100	Clamp-screw	— —	1	0.437
55	100	100 (J)	5	125	Clamp-screw	— —	1	0.437
55	100	100 (J)	5	150	Clamp-screw	— —	1	0.437
70	100	150 (J)	5	150 (RK5)	Double lug-clamp	— —	1	1.020
90	100	150 (J)	5	150 (RK5)	Double lug-clamp	— —	1	1.020
100	100	200 (J)	10	200 (RK5)	Double lug-clamp	— —	1	1.020
115	100	200 (J)	10	200 (RK5)	Double lug-clamp	— —	1	1.020
115	100	200 (J)	10	200 (RK5)	Double lug-clamp	— —	1	1.020
140	100	200 (J)	10	250 (RK5)	Double lug-clamp	— —	1	2.020
160	100	200 (J)	10	250 (RK5)	Double lug-clamp	— —	1	2.020
165	100	200 (J)	10	250 (RK5)	Double lug-clamp	— —	1	2.020
250	100	400 (J)	10	400 (RK5)	Screw-nut	— —	1	3.000
275	100	400 (J)	10	400 (RK5)	Screw-nut	— —	1	3.000
350	100	400 (J)	10	400 (RK5)	Screw-nut	— —	1	3.000
350	—	—	18	800 (L)	Screw-nut	— —	1	9.575
450	—	—	18	800 (L)	Screw-nut	— —	1	9.575
550	—	—	18	800 (L)	Screw-nut	— —	1	9.575
700	—	—	18 ¹	1200 (L)	Screw-nut	— —	1	18.000
800	—	—	18 ¹	1500 (L)	Screw-nut	— —	1	18.620
1000	—	—	18 ¹	1500 (L)	Screw-nut	— —	1	21.400
No UL	—	—	—	—	Screw-nut	2 4	1	48.000
No UL	—	—	—	—	Screw-nut	2 4	1	50.000

¹ For use at this other current value, a 16mm² cable, headed with a fork terminal, must be used.
¹ No UL/CSA ratings; data given for indication and reference purposes only.
² Definite-purpose (DP) contactors are available. Consult Technical support for information; see contact details on inside front cover.
³ The contactor coil is controlled electronically; it can have either an AC or a DC supply and has a wide operating range.
 Complete the order code only with the digit of the coil voltage.
 Standard voltages are:
 - AC/DC 024 = 24...60VAC/20...60VDC; 110 = 60...130VAC/DC; 230 = 100...250VAC/DC;
 400 = 250...500VAC/DC.
⁴ The values in brackets indicate the class of the fuse to be used.
 Where there is no value in brackets, any type of fuse can be used.
 For protection with motor protection circuit breaker (type F combination motor controller) see chapter 1.

Certifications and compliance

Certifications obtained:

Type	cULus	UL	CSA	EAC	CCC	Register of shipping	
						RINA	LRS
BG06A	●			●	●		
BG09A	●			●	●		
BG12A	●			●	●		
BGF09A	●			●	●		
BGP...A ⁴	● ¹			●	●		
BF09A	●		●	●	●	●	
BF12A	●		● ⁵	●	●	●	
BF18A	●		●	●	●	●	
BF25A	●		● ⁵	●	●	●	
BF26A	●		●	●	●	●	
BF32A	●		●	●	●	●	
BF38A	●		● ⁵	●	●	●	
BF40A	●			●	●	●	
BF50A	●			●	●	●	
BF65A	● ⁵			●	●	●	
BF80A	●			●	●	●	
BF94A	●						
BF95A	● ⁵						●
BF115A	●						●
BF150A	● ⁵						●
B160	●			● ⁶	● ⁶		
B195	●			● ⁶	● ⁶		
B230	●			● ⁶	● ⁶		
B250	●	●	●	●	●	●	●
B310	●	●	●	●	●	●	●
B400	●	●	●	●	●	●	●
B500	●			●			
B630	●			●			
B6301000	●			●			
B1250				●			
B1600				●			

● Certified products.

UL - UL Listed, for USA and Canada (cULus - File E93602) for BG...BF150 types indicated, as Motor Controllers - Contactors, except for BGP09... types which are UL Recognized, for USA and Canada (File E93602 - Component - Products having this type of marking are intended for use as components of complete workshop-assembled equipment).
 BGP is UL rated up to 300V; for type with rating up to 600V, consult Technical support for information - see contact details on inside front cover.
 UL Listed for USA only (File E93602) for B250...B400 types indicated, as Motor Controllers - Contactors.
 UL Listed for USA and Canada (cULus - File E172189) for B500...B6301000 and B500SL... B630SL types as Industrial Control Switches.
 CSA - BF09...BF95 and B250...B400 contactors are also CSA certified, for Canada only (File 54332).
 In addition, BF12... BF25... and BF38... types are CSA certified as "Elevator Equipment" (File 54332, class 2411); BF65 is UL certified as "Elevator Equipment" (File E 93602).
 See technical characteristics on page 2-70.

⁵ This contactor has also achieved elevator equipment certification.
⁶ Pending.

Compliant with standards: IEC/EN/BS 60947-1, IEC/EN/BS 60947-4-1, UL508, CSA C22.2 n° 14; UL 60947-1, UL 60947-4-1, CSA C22.2 n° 60947-1, CSA C22.2 n° 60947-4-1. Plastic materials are compliant with standards IEC/EN/BS 60335; for all BF09...BF38 versions only, add suffix V260 to the standard product order code.
 Example: BF0910A230V260 for BF09, three poles, with one NO contact and 230V 50/60Hz coil with compliant plastic materials.
 Note: The contactors that have incorporated NC auxiliary contacts comply with annex F of the IEC/EN/BS 60947-4-1 standard "auxiliary contact linked with power contact" also known as mirror contacts.

2 Contactors

Three-pole contactors with DC and AC/DC control circuit



INDEX



BG06D...BG12D
BG09L



BF09D...BF25D
BF09L...BF25L



BF26D-BF38D
BF26L-BF38L



BF40E...BF94E



BF95E...BF150E

new



BF160E...BF230E



B250...B400

Order code		Three-phase motor control								UL/CSA details									
DC coil	DC coil	IEC operating current I _{th} (AC1)			I _e (AC3) ≤440V at ≤55°C	Maximum IEC power at ≤55°C (AC3)								Maximum UL/CSA horsepower ratings					
		≤40°C	≤55°C	≤70°C		230V	400V	415V	440V	500V	690V	1000V	Single phase	Three phase					
	Low consumption	[A]	[A]	[A]	[A]	[kW]	[kW]	[kW]	[kW]	[kW]	[kW]	[kW]	[kW]	[HP]	[HP]	[HP]	[HP]	[HP]	[HP]
11BG0601D	—	16	14	12	6	1.5	2.2	2.4	2.5	3	3	—	1/3	1	1 1/2	2	3	3	3
11BG0610D	—																		
11BG0901D	11BG0901L	20	18	15	9	2.2	4	4.3	4.5	5	5	—	1/2	1 1/2	2	3	5	5	5
11BG0910D	11BG0910L																		
11BGF0901D	11BGF0901L	20	18	15	9	2.2	4	4.3	4.5	5	5	—	1/2	1 1/2	2	3	5	5	5
11BGF0910D	11BGF0910L																		
11BGP0901D	—	20	18	15	9	2.2	4	4.3	4.5	5	—	—	1/2	1 1/2	2	3	5	—	—
11BGP0910D	—																		
11BG1201D	—	20	18	15	12	3.2	5.7	6.2	5.5	5	5	—	1/2	1 1/2	3	3	7 1/2	10	10
11BG1210D	—																		
BF0901D	BF0901L	25	20	18	9	2.2	4.2	4.5	4.8	5.5	7.5	—	3/4	2	3	3	5	7 1/2	7 1/2
BF0910D	BF0910L																		
BF1201D	BF1201L	28	23	20	12	3.2	5.7	6.2	6.2	7.5	10	—	1	2	5	5	7 1/2	10	10
BF1210D	BF1210L																		
BF1801D	BF1801L	32	26	23	18	4	7.5	9	9	10	10	—	1	3	5	5	10	15	15
BF1810D	BF1810L																		
BF2501D	BF2501L	32	26	23	25	7	12.5	13.4	13.4	15	11	—	2	3	7 1/2	7 1/2	15	15	15
BF2510D	BF2510L																		
BF2600D	BF2600L	45	36	32	26	7.3	13	14	14	15.6	18.5	—	2	5	7 1/2	7 1/2	15	20	20
BF3200D	BF3200L	56	45	40	32	8.8	18	17	17	20	22	—	3	7 1/2	10	10	20	25	25
BF3800E	BF3800L	56 (60)	45 (48)	40 (42)	38	11	18.5	18.5	18.5	20	22	—	3	7 1/2	10	15	30	30	30
BF4000E	—	70	60	50	40	11	18.5	22	22	22	30	18.5	3	7 1/2	10	15	30	30	30
BF5000E	—	90	75	65	50	15	22	30	30	30	37	22	5	10	15	20	40	40	40
BF6500E	—	100	80	70	65	18.5	30	37	37	37	45	30	—	—	20	25	50	60	60
BF8000E	—	115	95	80	80	22	45	45	45	55	55	37	—	—	25	30	60	75	75
BF9400E	—	115	95	80	95	30	55	55	55	55	55	37	—	—	25	30	60	75	75
BF9500E	—	140	115	100	95	30	55	55	55	75	90	45	—	—	30	30	60	75	75
BF11500E	—	160	130	115	115	37	55	55	55	75	110	55	—	—	40	40	75	100	100
BF15000E	—	165	135	118	150	45	75	75	75	90	110	55	—	—	50	50	100	125	125
BF16000E	—	250	210	180	160	45	75	90	90	110	132	75	—	—	50	60	125	150	150
BF19500E	—	275	230	200	195	55	90	110	110	132	160	90	—	—	60	75	150	150	150
BF23000E	—	350	290	250	230	55	110	110	132	132	160	110	—	—	75	75	150	200	200
11B25000E	—	350	300	250	265	83	140	155	164	176	212	156	—	—	75	100	200	250	250
11B31000E	—	450	370	300	320	100	170	188	200	213	256	180	—	—	100	125	250	300	300
11B40000E	—	550	430	360	420	130	225	247	263	271	352	208	—	—	125	150	350	400	400
11B50000E	—	700	550	500	520	156	290	306	328	367	416	312	—	—	150	200	400	450	450
11B63000E	—	800	640	540	630	198	335	368	368	368	440	368	—	—	200	250	500	500	500
11B630100000E	—	1000	850	700	—	For AC1/Resistive duty only, see page 2-8.								—	—	—	—	—	—

- Complete order code with coil voltage digit.
For BG09...D 24VDC version complete with built-in surge suppressor, add suffix **V120** to the standard order code.
The BF09-BF38D types already have a standard supplied built-in TVS (Transient Voltage Suppressor). Standard voltages are as follows:
- DC 012 / 024 / 048 / 060 / 110 / 125 / 220V.
Example: 11BG0610D012 for mini-contactor BG06, three poles, with one NO contact and 12VDC coil.
11BG0910D024 V120 for mini-contactor BG09, three poles, with one NO contact and 24VDC coil, complete with built-in TVS (diode) suppressor.
- Low-consumption version.
No add-on auxiliary contacts or mechanical interlock can be mounted on BG... type contactors. Complete order code with coil voltage digit.
The BF09-BF38L types already have a standard supplied built-in TVS (Transient Voltage Suppressor). Standard voltages are as follows:
- DC 024 / 048V.
Example: 11BG0901L024 for mini-contactor BG09, three poles, with one NC contact and 24VDC low-consumption coil.
- The contactor coil is controlled electronically; it can have either an AC or a DC supply and has a wide operating range.
The order code must be completed with the coil voltage digit.

- The standard voltages are as follows:
- AC/DC 024 = 20...48V; 110 = 60...110V; 230 = 100...250V.
- The coil of the contactor can be powered indifferently in AC or DC. Complete the order code only with the digit of the coil voltage.
Standard voltages are:
- AC/DC 24 / 48 / 60 / 110-125 (indicate 110) / 220-240 (indicate 220) / 380-415 (indicate 380) / 440-480V (indicate 440).
Example: 11B25000110 for contactor B250, three poles, without auxiliary contacts and with 110-125VAC/DC coil.
- The 24VAC/DC voltage is not possible for B500...B6301000 contactors.
Other voltages available on request.
- If predisposed for mechanical latch (G495), the order code becomes 11B...SL00.
- If already fitted with mechanical latch (G495), the order code becomes 11B...L00.
- Indicate rated voltage of the mechanical latch, preceded by the letter C if in DC.
Standard voltages are:
- AC 50/60Hz 48 / 110-125 indicate 110 / 220-240 indicate 220 / 380-415V indicate 380
- DC 48 / 110-125 indicate 110 / 220-240V indicate 220.
Example: 11B250L00110C48 for contactor B250, three poles, without auxiliary contacts, with 110-125VAC/DC coil and mechanical latch powered at 48VDC.

2 Contactors

Three-pole contactors with DC and AC/DC control circuit



B500-B630



B6301000

UL/CSA General (purpose) use	UL/CSA Short-circuit protection fuse, 600V [Ⓛ]					Type of terminal	Incorporated auxiliary contacts	Qty per pkg	Wt
	High fault		Standard fault						
	Short circuit current	Fuse	Short circuit current	Fuse	Fuse				
[A]	[kA]	[A]	[kA]	[A]		NO	NC	n°	[kg]
16	100	30 (J)	5	30	Clamp-screw	— 1 [Ⓛ]	—	10	0.214
						1 [Ⓛ] —	—	10	0.214
20	100	30 (J)	5	30	Clamp-screw	— 1 [Ⓛ]	—	10	0.214
						1 [Ⓛ] —	—	10	0.214
20	100	30 (J)	5	30	Faston	— 1 [Ⓛ]	—	10	0.210
						1 [Ⓛ] —	—	10	0.210
20	100	30 (J)	5	30	Rear PCB solder pin	— 1 [Ⓛ]	—	10	0.240
						1 [Ⓛ] —	—	10	0.240
20	100	30 (J)	5	30	Clamp-screw	— 1 [Ⓛ]	—	10	0.214
						1 [Ⓛ] —	—	10	0.214
25	100	30 (J)	5	60	Clamp-screw	— 1 [Ⓛ]	—	1	0.494
						1 —	—	1	0.494
28	100	30 (J)	5	70	Clamp-screw	— 1 [Ⓛ]	—	1	0.494
						1 —	—	1	0.494
32	100	60 (J)	5	80	Clamp-screw	— 1 [Ⓛ]	—	1	0.494
						1 —	—	1	0.494
32	100	60 (J)	5	100	Clamp-screw	— 1 [Ⓛ]	—	1	0.494
						1 —	—	1	0.494
45	100	100 (J)	5	100	Clamp-screw	— —	—	1	0.559
55	100	100 (J)	5	125	Clamp-screw	— —	—	1	0.559
55	100	100 (J)	5	150	Clamp-screw	— —	—	1	0.559
70	100	150 (J)	5	150 (RK5)	Double lug-clamp	— —	—	1	1.050
90	100	150 (J)	5	150 (RK5)	Double lug-clamp	— —	—	1	1.050
100	100	200 (J)	10	200 (RK5)	Double lug-clamp	— —	—	1	1.050
115	100	200 (J)	10	200 (RK5)	Double lug-clamp	— —	—	1	1.050
115	100	200 (J)	10	200 (RK5)	Double lug-clamp	— —	—	1	1.050
140	100	200 (J)	10	250 (RK5)	Double lug-clamp	— —	—	1	2.060
160	100	200 (J)	10	250 (RK5)	Double lug-clamp	— —	—	1	2.060
165	100	200 (J)	10	250 (RK5)	Double lug-clamp	— —	—	1	2.060
250	100	400 (J)	10	400 (RK5)	Screw-nut	— —	—	1	3.000
275	100	400 (J)	10	400 (RK5)	Screw-nut	— —	—	1	3.000
350	100	400 (J)	10	400 (RK5)	Screw-nut	— —	—	1	3.000
350	—	—	18	800 (L)	Screw-nut	— —	—	1	9.635
450	—	—	18	800 (L)	Screw-nut	— —	—	1	9.635
500	—	—	18	800 (L)	Screw-nut	— —	—	1	9.635
700 [Ⓛ]	—	—	18 [Ⓛ]	1200 (L)	Screw-nut	— —	—	1	18.060
800 [Ⓛ]	—	—	18 [Ⓛ]	1500 (L)	Screw-nut	— —	—	1	18.620
1000	—	—	18 [Ⓛ]	1500 (L)	Screw-nut	— —	—	1	21.400

- Ⓛ G495 mechanical latch cannot be mounted.
- Ⓛ Maximum voltage is limited at 300V for UL. For certified type up to 600V, consult Technical support for information; see contact details on inside front cover.
- Ⓛ Highly conductive auxiliary contact.
- Ⓛ For use at this other current value, a 16mm² cable, headed with a fork terminal, must be used.
- Ⓛ No UL/CSA ratings; data given for indication and reference purposes only.
- Ⓛ Definite-purpose (DP) contactors are available. Consult Technical support for information; see contact details on inside front cover.
- Ⓛ The contactor coil is controlled electronically; it can have either an AC or a DC supply and has a wide operating range.
Complete the order code only with the digit of the coil voltage.
Standard voltages are:
— AC/DC 024 = 24...60VAC/20...60VDC; 110 = 60...130VAC/DC; 230 = 100...250VAC/DC;
400 = 250...500VAC/DC.
- Ⓛ The values in brackets indicate the class of the fuse to be used.
Where there is no value in brackets, any type of fuse can be used.
For protection with motor protection circuit breaker (type F combination motor controller) see chapter 1.

Certifications and compliance

Certifications obtained:

Type	cULus	UL	CSA	EAC	CCC	RINA
BG06D	●			●	●	
BG09D	●			●	●	
BG12D	●			●	●	
BGF09D	●			●	●	
BGP09D [Ⓛ]	●	●	●			
BF09D - BF09L	●		●	●	●	●
BF12D - BF12L	●		● [Ⓛ]	●	●	●
BF18D - BF18L	●		●	●	●	●
BF25D - BF25L	●		● [Ⓛ]	●	●	●
BF26D - BF26L	●		●	●	●	●
BF32D - BF32L	●		●	●	●	●
BF38D - BF38L	●		● [Ⓛ]	●	●	●
BF40E	●			●	●	
BF50E	●			●	●	
BF65E	● [Ⓛ]			●	●	
BF80E	●			●	●	
BF94E	●					
BF95E	● [Ⓛ]					
BF115E	●					
BF150E	● [Ⓛ]					
B195E	●			Ⓛ	Ⓛ	
B160E	●			Ⓛ	Ⓛ	
B230E	●			Ⓛ	Ⓛ	
B250		●	●	●	●	●
B310		●	●	●	●	●
B400		●	●	●	●	●
B500	●			●		
B630	●			●	●	
B6301000	●			●		

● Certified products.

- UL - UL Listed, for USA and Canada (cULus File E93602) for BG...BF110 types indicated, as Motor Controllers - Contactors, except for BGP09... types which are UL Recognized, for USA and Canada (cULus File E93602 - Component). Products having this type of marking are intended for use as components of complete workshop-assembled equipment.
BGP is UL rated up to 300V; for type with rating up to 600V, consult Technical support for information - see contact details on inside front cover.
UL Listed for USA only (File E93602) for B250...B400 types indicated, as Motor Controllers - Contactors.
UL Listed for USA and Canada (cULus - File E172189) for B500...B630 1000 and B500 SL... B630 SL types as Industrial Control Switches.
- CSA - BF09...BF95 and B250...B400 contactors are also CSA certified, for Canada only (File 54332).
In addition, BF12... BF25... and BF38... types are CSA certified as "Elevator Equipment" (File 54332, class 2411); BF65 is UL certified as "Elevator Equipment" (File E 93602).
See technical characteristics on page 2-70.

- Ⓛ This contactor has also achieved elevator equipment certification.
- Ⓛ Pending.

Compliant with standards: IEC/EN/BS 60947-1, IEC/EN/BS 60947-4-1, UL508, CSA C22.2 n° 14; UL 60947-1, UL 60947-4-1, CSA C22.2 n° 60947-1, CSA C22.2 n° 60947-4-1. Plastic materials are compliant with standards IEC/EN/BS 60335; for all BF09...BF38 versions only, add suffix V260 to the standard product order code.
Example: BF09 10 D024 V260 for BF09, three poles, with one NO contact and 24VDC coil with compliant plastic materials.
Note: The contactors that have incorporated NC auxiliary contacts comply with annex F of the IEC/EN/BS 60947-4-1 standard "auxiliary contact linked with power contact" also known as mirror contacts.

2 Contactors

Four-pole contactors with AC control circuit



BG09T4A **BF09AT4A...BF18T4A** **BF26T4A...BF38T4A** **BF40T4A...BF80T4A** **BF95T4A...BF150T4A** **BF160T4E...BF230T4E** **B2504...B4004**

Resistive load control												UL/CSA details
Order code	IEC operating current Ith (AC1)				Maximum IEC power at ≤40°C (AC1)							UL/CSA General (purpose) use
	≤40°C	≤55°C	≤70°C	Ie (AC3) ≤440V at ≤55°C	230V	400V	415V	440V	500V	690V	1000V	
AC coil	[A]	[A]	[A]	[A]	[kW]	[kW]	[kW]	[kW]	[kW]	[kW]	[kW]	[A]
11BG09T4A	20	18	15	9	8	14	14	15	16	22	—	20
11BGF09T4A	20	18	15	9	8	14	14	15	16	22	—	20
11BGP09T4A	20	18	15	9	8	14	14	15	16	—	—	20
BF09T4A	25	20	18	9	9.5	16	17	18	21	27	—	25
BF12T4A	28	23	20	12	10	18	19	20	23	32	—	28
BF18T4A	32	26	23	18	12	21	22	23	26	36	—	32
BF26T4A	45	36	32	26	17	30	31	33	37	51	—	45
BF38T4A	56 (60)	45 (48)	40 (42)	38	21	36	38	40	45	62	—	55
BF40T4A	70	60	50	40	26	46	48	51	58	79	115	70
BF50T4A	90	75	65	50	34	59	61	65	74	102	148	90
BF65T4A	100	80	70	65	38	65	68	72	82	114	165	100
BF80T4A	115	95	80	80	43	76	79	83	95	120	185	115
BF95T4A	140	115	100	95	53	92	96	101	115	159	230	140
BF115T4A	160	130	115	115	61	105	109	116	132	182	263	160
BF150T4A	165	135	118	150	62	110	113	119	136	187	271	165
BF160T4E	250	210	180	160	95	165	171	181	206	284	411	250
BF195T4E	275	230	200	195	104	181	188	199	226	312	452	275
BF230T4E	350	290	250	230	132	230	239	253	288	397	576	350
11B250400	350	300	250	265	124	214	234	255	282	380	560	350
11B310400	450	370	300	320	158	270	293	325	350	488	700	450
11B400400	550	430	360	420	200	345	377	400	452	598	870	550
11B500400	700	550	500	520	252	438	478	500	575	755	1100	700
11B630400	800	640	540	630	288	500	545	580	655	860	1250	800
11B6301000400	1000	850	700	—	350	600	630	725	750	1000	1600	1000
11B1250424	1250	1050	880	—	480	830	900	905	1100	1450	2000	No UL/CSA
11B1600424	1600	1360	1120	—	550	950	1000	1160	1200	1650	2500	No UL/CSA

- ① Complete order code with coil voltage digit or voltage digit followed by 60 if 60Hz. Standard voltages are as follows:
 - AC 50/60Hz 024 / 048 / 110 / 230 / 400V
 - AC 60Hz 024 60 / 048 60 / 120 60 / 220 60 / 230 60 / 460 60 / 575 60 (V).
 Example: 11BG09T4A230 for mini-contactor BG09, four poles, with 230VAC 50/60Hz coil. 11BGP09T4A460 60 for mini-contactor BG09, four poles, with 460VAC 60Hz coil.
- ② The coil of the contactor can be powered indifferently in AC or DC. Complete the order code only with the digit of the coil voltage. Standard voltages are:
 - AC/DC 24 / 48 / 60 / 110-125 (indicate 110) / 220-240 (indicate 220) / 380-415 (indicate 380) / 440-480V (indicate 440).
 Example: 11B250400110 for contactor B250, four poles, without auxiliary contacts and with 110-125VAC/DC coil.
The 24VAC/DC voltage is not possible for B500...B6301000 contactors.
 Other voltages available on request.
- ③ If predisposed for mechanical latch (G495), the order code becomes 11B...4SL00 ②.
 If already fitted with mechanical latch (G495), the order code becomes 11B...4L00 ② ④.
- ④ Indicate rated voltage of the mechanical latch, preceded by the letter C if in DC. Standard voltages are:
 - AC 50/60Hz 48 / 110-125 indicate 110 / 220-240 indicate 220 / 380-415V indicate 380
 - DC 48 / 110-125 indicate 110 / 220-240V indicate 220.
 Example: 11B2504L00110C220 for contactor B250, four poles, without auxiliary contacts, with 110-125VAC/DC coil and mechanical latch powered at 220-240VDC.
- ⑤ G495 mechanical latch cannot be mounted.
- ⑥ Complete the order code with the digit of the coil voltage. For 110-125VAC 50/60Hz indicate 110 or 220-240VAC 50/60Hz indicate 220.
 Example: 11B1250424110 for contactor B1250, four poles, with 2NO+4NC auxiliary contacts and 110-125VAC/DC 50/60Hz coil.
- ⑦ Maximum voltage is limited at 300V for UL. For certified type up to 600V. Consult Technical support for information; see contact details on inside front cover.
- ⑧ Whenever the BF26T4 or BF38T4 types need to be mechanically interlocked with either the BFX5000 or BFX5001, the add-on fourth pole of one of the contactors needs to be removed from the right side and fitted on the left side.
- ⑨ For use at this other current value, a 16mm² cable, headed with a fork terminal, must be used.
- ⑩ Definite-purpose (DP) contactors are available. Consult Technical support for information; see contact details on inside front cover.

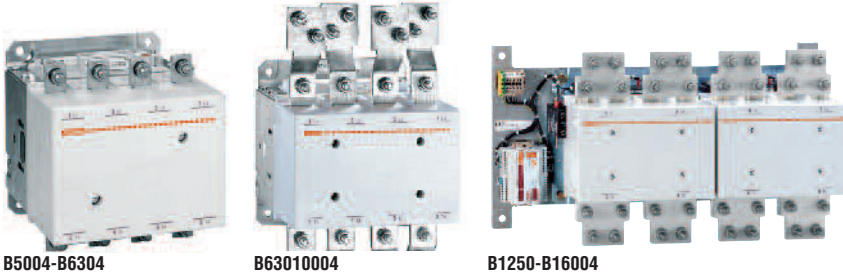

B5004-B6304

B63010004

B1250-B16004

UL/CSA Short-circuit protection fuse, 600V [Ⓢ]				Type of terminal	Incorporated auxiliary contacts		Qty per pkg n°	Weight [kg]
High fault Short circuit current		Standard fault Short circuit current			NO	NC		
Fuse [kA]	Fuse [A]	Fuse [kA]	Fuse [A]					
100	30 (J)	5	30	Clamp-screw	—	—	10	0.180
100	30 (J)	5	30	Faston	—	—	10	0.180
100	30 (J)	5	30	Rear PCB solder pin	—	—	10	0.197
100	30 (J)	5	60	Clamp-screw	—	—	1	0.367
100	30 (J)	5	70	Clamp-screw	—	—	1	0.367
100	60 (J)	5	80	Clamp-screw	—	—	1	0.367
100	100 (J)	5	100	Clamp-screw	—	—	1	0.508
100	100 (J)	5	150	Clamp-screw	—	—	1	0.508
100	150 (J)	5	150 (RK5)	Double lug-clamp	—	—	1	1.240
100	150 (J)	5	150 (RK5)	Double lug-clamp	—	—	1	1.240
100	200 (J)	10	200 (RK5)	Double lug-clamp	—	—	1	1.240
100	200 (J)	10	200 (RK5)	Double lug-clamp	—	—	1	1.240
100	200 (J)	10	250 (RK5)	Double lug-clamp	—	—	1	2.420
100	200 (J)	10	250 (RK5)	Double lug-clamp	—	—	1	2.420
100	200 (J)	10	250 (RK5)	Double lug-clamp	—	—	1	2.420
100	400 (J)	10	400 (RK5)	Screw-nut	—	—	1	4.000
100	400 (J)	10	400 (RK5)	Screw-nut	—	—	1	4.000
100	400 (J)	10	400 (RK5)	Screw-nut	—	—	1	4.000
—	—	18	800 (L)	Screw-nut	—	—	1	11.195
—	—	18	800 (L)	Screw-nut	—	—	1	11.195
—	—	18	800 (L)	Screw-nut	—	—	1	11.195
—	—	18 [Ⓢ]	1200 (L)	Screw-nut	—	—	1	20.910
—	—	18 [Ⓢ]	1500 (L)	Screw-nut	—	—	1	21.880
—	—	18 [Ⓢ]	1500 (L)	Screw-nut	—	—	1	25.620
—	—	—	—	Screw-nut	2	4	1	57.500
—	—	—	—	Screw-nut	2	4	1	58.400

- Ⓢ IEC/EN/BS 60947-1 designation: Pillar terminal.
- Ⓢ The contactor coil is controlled electronically; it can have either an AC or a DC supply and has a wide operating range. Complete the order code only with the digit of the coil voltage.
Standard voltages are:
— AC/DC 024 = 24...60VAC/20...60VDC; 110 = 60...130VAC/DC; 230 = 100...250VAC/DC; 400 = 250...500VAC/DC.
- Ⓢ The values in brackets indicate the class of the fuse to be used. Where there is no value in brackets, any type of fuse can be used. For protection with motor protection circuit breaker (type F combination motor controller) see chapter 1.

IEC utilisation current with poles in parallel

If the poles of the contactors are arranged in parallel, the operating current is the one indicated in the table multiplied by the **K** factor given below, which account for the unequal distribution of the current in the various poles. To limit distribution inequality, it is advisable to use paralleling links (see pages 2-18, 2-23, 2-28 and 2-30).

- 2 POLES in parallel: **K = 1.6**
- 3 POLES in parallel: **K = 2.2**
- 4 POLES in parallel: **K = 2.8**

Certifications and compliance

Certifications obtained:

Type	cULus	UL	CSA	EAC	CCC	RINA
BG09T4A	●			●	●	
BGF09T4A	●			●	●	
BGP09T4A [Ⓢ]	● [Ⓢ]			●	●	
BF09T4A	●		●	●	●	●
BF12T4A	●		● [Ⓢ]	●	●	●
BF18T4A	●		●	●	●	●
BF26T4A	●		● [Ⓢ]	●	●	●
BF38T4A	●		● [Ⓢ]	●	●	●
BF40T4A	●			●	●	●
BF50T4A	●			●	●	●
BF65T4A	● [Ⓢ]			●	●	●
BF80T4A	●			●	●	●
BF95T4A	● [Ⓢ]					●
BF115T4A	●					●
BF150T4A	● [Ⓢ]					●
BF160T4E	●			● [Ⓢ]	● [Ⓢ]	
BF195T4E	●			● [Ⓢ]	● [Ⓢ]	
BF230T4E	●			● [Ⓢ]	● [Ⓢ]	
B2504		●	●	●	●	
B3104		●	●	●	●	
B4004		●	●	●	●	
B5004	●			●		
B6304	●			●	●	
B63010004	●			●		
B12504				●		
B16004				●		

● Certified products.

- UL - UL Listed, for USA and Canada (cULus File E93602) for BG...BF150 types indicated, as Motor Controllers – Contactors, except for BGP09... types which are UL Recognized, for USA and Canada (cULus File E93602 – Component). Products having this type of marking are intended for use as components of complete workshop-assembled equipment. BGP is UL rated up to 300V; for type with rating up to 600V, consult Technical support for information – see contact details on inside front cover.
- UL Listed for USA only (File E93602) for B250...B400 types indicated, as Motor Controllers – Contactors.
- UL Listed for USA and Canada (cULus - File E172189) for B5004... B63010004 and B5004SL... B6304SL types as Industrial Control Switches.
- CSA - BF09...BF80 and B250...B400 contactors are also CSA certified, for Canada only (File 54332).
- In addition, BF12... BF25... BF38... and BF65... types are CSA certified as "Elevator Equipment" (File 54332, class 2411). See technical characteristics on page 2-70.

- Ⓢ This contactor has also achieved elevator equipment certification.
- Ⓢ Pending.

Compliant with standards: IEC/EN/BS 60947-1, IEC/EN/BS 60947-4-1, UL508, CSA C22.2 n° 14; UL 60947-1, UL 60947-4-1, CSA C22.2 n° 60947-1, CSA C22.2 n° 60947-4-1. Plastic materials are compliant with standards IEC/EN/BS 60335; for all BF09...BF38 versions only, add suffix V260 to the standard product order code. Example: BF09T4A230V260 for BF09, four poles, 230V 50/60Hz coil with compliant plastic materials.

2 Contactors

Four-pole contactors with DC and AC/DC control circuit



INDEX



BG09T4D



BF09T4D-BF18T4D
BF09T4L-BF18T4L



BF26T4D-BF38T4D
BF26T4L-BF38T4L



BF65T4E
BF80T4E



BF95T4E...BF150T4E

new



BF160T4E...BF230T4E



B2504...B4004

Resistive load control

Order code DC coil	DC coil Low consumption	IEC operating current I _{th} (AC1)			I _e (AC3) ≤440V at ≤55°C	Maximum IEC power at ≤40°C (AC1)							UL/CSA details
		≤40°C	≤55°C	≤70°C		230V	400V	415V	440V	500V	690V	1000V	UL/CSA General (purpose) use
		[A]	[A]	[A]	[A]	[kW]	[kW]	[kW]	[kW]	[kW]	[kW]	[kW]	[A]
11BG09T4D ^①	—	20	18	15	9	8	14	14	15	16	22	—	20
11BGF09T4D ^①	—	20	18	15	9	8	14	14	15	16	22	—	20
11BGP09T4D ^①	—	20	18	15	9	8	14	14	15	16	—	—	20 ^⑤
BF09T4D ^①	BF09T4L ^②	25	20	18	9	9.5	16	17	18	21	27	—	25
BF18T4D ^①	BF18T4L ^②	32	26	23	18	12	21	22	23	26	36	—	32
BF26T4D ^①	BF26T4L ^②	45	36	32	26	17	30	31	33	37	51	—	45
BF38T4D ^①	BF38T4L ^②	56 (60 ^⑦)	45 (48 ^⑦)	40 (42 ^⑦)	38	21	26	38	40	45	62	—	55
BF65T4E ^③	—	100	80	70	65	38	65	68	72	82	114	165	100
BF80T4E ^③	—	115	95	80	80	43	76	79	83	95	120	185	115
BF95T4E ^③	—	140	115	100	95	53	92	96	101	115	159	230	140
BF150T4E ^③	—	165	135	118	150	62	110	113	119	136	187	271	165
BF160T4E ^④	—	250	210	180	160	95	165	171	181	206	284	411	250
BF195T4E ^④	—	275	230	200	195	104	181	188	199	226	312	452	275
BF230T4E ^④	—	350	290	250	230	132	230	239	253	288	397	576	350
11B250400 ^{④⑤}	—	350	300	250	265	124	214	234	255	282	380	560	350
11B310400 ^{④⑦}	—	450	370	300	320	158	270	293	325	350	488	700	450
11B400400 ^{④⑤}	—	550	430	360	420	200	345	377	400	452	598	870	550
11B500400 ^{④⑤}	—	700	550	500	520	252	438	478	500	575	755	1100	700
11B630400 ^{④⑤}	—	800	640	540	630	288	500	545	580	655	860	1250	800
11B6301000400 ^{④⑤}	—	1000	850	700	—	350	600	630	725	750	1000	1600	1000

- ① Complete order code with coil voltage digit. The BF09-BF38D types already have a standard supplied built-in TVS (Transient Voltage Suppressor). Standard voltages are as follows:
– DC 012 / 024 / 048 / 060 / 110 / 125 / 220VDC.
Example: 11BG09T4D012 for mini-contactor BG09, four poles, with 12VDC coil.
- ② Low consumption version. Complete the order code with coil voltage digit. The BF09-BF38L types already have a standard supplied built-in TVS (Transient Voltage Suppressor). Standard voltages are as follows:
– DC 024 / 048V
Example: BF09T4L024 for contactor BF09, four poles, with 24VDC low-consumption coil.
- ③ The contactor coil is controlled electronically; it can have either an AC or a DC supply and has a wide operating range. Complete the order code only with the digit of the coil voltage. Standard voltages are:
– AC/DC 024 = 20...48V; 110 = 60...110V; 230 = 100...250V.
- ④ The coil of the contactor can be powered indifferently in AC or DC. Complete the order code only with the digit of the coil voltage. Standard voltages are:
– AC/DC 24 / 48 / 60 / 110-125 indicate 110 / 220-240 indicate 220 / 380-415 indicate 380 / 440-480V indicate 440.
Example: 11B25000110 for contactor B250, four poles, without auxiliary contacts and with 110-125VAC/DC coil.
The 24VAC/DC voltage is not possible for B500-B630 1000 contactors.
The 24V voltage is not possible for B500...B6301000 contactors.
Other voltages available on request.
- ⑤ If predisposed for mechanical latch (G495), the order code becomes 11B...4SL00 ④. If already fitted with mechanical latch (G495), the order code becomes 11B...4L00 ④ ⑥.

- ⑥ Indicate rated voltage of the mechanical latch, preceded by the letter C if in DC. Standard voltages are:
– AC 50/60Hz 48 / 110-125 indicate 110 / 220-240 indicate 220 / 380-415V indicate 380
– DC 48 / 110-125 indicate 110 / 220-240V indicate 220.
Example: 11B250L00110C48 for contactor B250, four poles, without auxiliary contacts, with 110-125VAC/DC coil and mechanical latch powered at 48VDC.
- ⑦ G495 mechanical latch cannot be mounted.
- ⑧ Maximum voltage is limited at 300V for UL. For certified type up to 600V consult Technical support for information; see contact details on inside front cover.
- ⑨ For use at this other current value, a 16mm² cable, headed with a fork terminal, must be used.

2 Contactors

Four-pole contactors with DC and AC/DC control circuit



B5004-B6304



B63010004

UL/CSA Short-circuit protection fuse, 600V [Ⓢ]				Type of terminal	Incorporated auxiliary contacts		Qty per pkg n°	Weight [kg]
High fault Short circuit current		Standard fault Short circuit current			NO	NC		
[kA]	Fuse [A]	[kA]	Fuse [A]					
100	30 (J)	5	30	Clamp-screw	—	—	10	0.220
100	30 (J)	5	30	Faston	—	—	10	0.220
100	30 (J)	5	30	Rear PCB solder pin	—	—	10	0.242
100	30 (J)	5	60	Clamp-screw	—	—	1	0.498
100	60 (J)	5	80	Clamp-screw	—	—	1	0.498
100	100 (J)	5	100	Clamp-screw	—	—	1	0.665
100	100 (J)	5	150	Clamp-screw	—	—	1	0.665
100	200 (J)	10	200 (RK5)	Double lug-clamp	—	—	1	1.280
100	200 (J)	10	200 (RK5)	Double lug-clamp	—	—	1	1.280
100	200 (J)	10	250 (RK5)	Double lug-clamp	—	—	1	2.460
100	200 (J)	10	250 (RK5)	Double lug-clamp	—	—	1	2.460
100	400 (J)	10	400 (RK5)	Screw-nut	—	—	1	4.000
100	400 (J)	10	400 (RK5)	Screw-nut	—	—	1	4.000
100	400 (J)	10	400 (RK5)	Screw-nut	—	—	1	4.000
—	—	18	800 (L)	Screw-nut	—	—	1	11.195
—	—	18	800 (L)	Screw-nut	—	—	1	11.195
—	—	18	800 (L)	Screw-nut	—	—	1	11.195
—	—	18 [Ⓢ]	1200 (L)	Screw-nut	—	—	1	20.910
—	—	18 [Ⓢ]	1500 (L)	Screw-nut	—	—	1	21.880
—	—	18 [Ⓢ]	1500 (L)	Screw-nut	—	—	1	25.600

- Ⓢ No UL/CSA ratings; data given for indication and reference purposes only.
- Ⓢ The contactor coil is controlled electronically; it can have either an AC or a DC supply and has a wide operating range.
Complete the order code only with the digit of the coil voltage.
Standard voltages are:
– AC/DC 024 = 24...60VAC/20...60VDC; 110 = 60...130VAC/DC; 230 = 100...250VAC/DC;
400 = 250...500VAC/DC.
- Ⓢ The values in brackets indicate the class of the fuse to be used.
Where there is no value in brackets, any type of fuse can be used.
For protection with motor protection circuit breaker (type F combination motor controller) see chapter 1.

IEC utilisation current with poles in parallel

If the poles of the contactors are arranged in parallel, the operating current is the one indicated in the table multiplied by the **K** factor given below, which account for the unequal distribution of the current in the various poles.
To limit distribution inequality, it is advisable to use paralleling links (see pages 2-18, 2-23, 2-28 and 2-30).

- 2 POLES in parallel: **K** = 1.6
- 3 POLES in parallel: **K** = 2.2
- 4 POLES in parallel: **K** = 2.8

Certifications and compliance

Certifications obtained:

Type	cULus	UL	CSA	EAC	CCC	RINA
BG09T4D	●			●	●	
BGF09T4D	●			●	●	
BGP09T4D [Ⓢ]	●			●	●	
BF09T4D - BF09T4L	●		●	●	●	●
BF18T4D - BF18T4L	●		●	●	●	●
BF26T4D - BF26T4L	●		● [Ⓢ]	●	●	●
BF38T4D - BF38T4L	●		● [Ⓢ]	●	●	●
BF65T4E	● [Ⓢ]			●	●	
BF80T4E	●			●	●	
BF95T4E	● [Ⓢ]					
BF150T4E	● [Ⓢ]					
BF160T4E	●			● [Ⓢ]	● [Ⓢ]	
BF195T4E	●			● [Ⓢ]	● [Ⓢ]	
BF230T4E	●			● [Ⓢ]	● [Ⓢ]	
B2504		●	●	●	●	
B3104		●	●	●	●	
B4004		●	●	●	●	
B5004	●			●		
B6304	●			●	●	
B63010004	●			●		

● Certified products.

- UL - UL Listed, for USA and Canada (cULus File E93602) for BG...BF150 types indicated, as Motor Controllers – Contactors, except for BGP09... types which are UL Recognized, for USA and Canada (●[Ⓢ], File E93602 – Component). Products having this type of marking are intended for use as components of complete workshop-assembled equipment.
BGP is UL rated up to 300V; for type with rating up to 600V, consult Technical support for information – see contact details on inside front cover.
UL Listed for USA only (File E93602) for B250...B400 types indicated, as Motor Controllers – Contactors.
UL Listed for USA and Canada (cULus - File E172185) for B5004... B63010004 and B5004SL... B6304SL types as Industrial Control Switches.
- CSA - BF09...BF95 and B250...B400 contactors are also CSA certified, for Canada only (File 54332).
In addition, BF12..., BF25..., BF38... and BF65... types are CSA certified as "Elevator Equipment" (File 54332, class 2411).
See technical characteristics on page 2-70.

- Ⓢ This contactor has also achieved elevator equipment certification.
- Ⓢ Pending.

Compliant with standards: IEC/EN/BS 60947-1, IEC/EN/BS 60947-4-1, UL508, CSA C22.2 n° 14; UL 60947-1, UL 60947-4-1, CSA C22.2 n° 60947-1, CSA C22.2 n° 60947-4-1. Plastic materials are compliant with standards IEC/EN/BS 60335; for all BF09...BF38 versions only, add suffix V260 to the standard product order code.
Example: BF09T4D024V260 for BF09, four poles, 24VDC coil with compliant plastic materials.

Mini-contactor four power poles, 2 NO and 2 NC BG series



11BG09T2...

Order code	IEC rated conventional free air thermal current Ith			Qty per pkg	Wt [kg]
	≤40°C	≤55°C	≤60°C		
	[A]	[A]	[A]	n°	[kg]
AC COIL. Terminals: clamp screw.					
11BG09T2A	20	18	15	1	0.170
DC COIL. Terminals: clamp screw.					
11BG09T2D	20	18	15	1	0.175

Note: on 11BG09T2D, maximum 2 auxiliary contacts may be mounted.

Contactors four power poles, 2 NO and 2 NC BF series



BF09T2...

Order code	IEC rated conventional free air thermal current Ith			Qty per pkg	Wt [kg]
	≤40°C	≤55°C	≤60°C		
	[A]	[A]	[A]	n°	[kg]
AC COIL. Terminals: clamp screw.					
BF09T2A	25	20	18	1	0.340
BF18T2A	32	26	23	1	0.340
BF26T2A	45	36	32	1	0.420
BF38T2A	56 (60)	45 (48)	40 (42)	1	0.420
BF80T2A	115	95	75	1	1.075
DC COIL. Terminals: clamp screw.					
BF18T2D	32	26	23	1	0.470
BF26T2D	45	36	32	1	0.540
BF38T2D	56 (60)	45 (48)	40 (42)	1	0.540
BF80T2E	115	95	75	1	1.125
DC COIL. Low consumption (2.4W). Terminals: clamp screw.					
BF18T2L	32	26	23	1	0.470
BF26T2L	45	36	32	1	0.540
BF38T2L	56 (60)	45 (48)	40 (42)	1	0.540

Contactors four power poles, 4 NC BF series



BF18T0...

Order code	IEC rated conventional free air thermal current Ith			Qty per pkg	Wt [kg]
	≤40°C	≤55°C	≤60°C		
	[A]	[A]	[A]	n°	[kg]
AC COIL. Terminals: clamp screw.					
BF18T0A	32	26	23	1	0.340
BF26T0A	45	36	32	1	0.420
DC COIL. Terminals: clamp screw.					
BF18T0D	32	26	23	1	0.470
BF26T0D	45	36	32	1	0.540
DC COIL. Low consumption (2.4W). Terminals: clamp screw.					
BF18T0L	32	26	23	1	0.470

- Complete with coil voltage digit if 50/60Hz or with voltage digit followed by 60 if 60Hz. N.B.: For BF80T2, 50/60Hz coils are suitable for 50Hz only.
Standard voltages are:
- AC 50/60Hz 024 / 048 / 110 / 230 / 400V
- AC 60Hz 024 60 / 048 60 / 120 60 / 220 60 / 230 60 / 460 60 / 575 60 (V).

- Example:
- 11BG09T2A230 for mini-contactor BG09T2, 2 poles NO and 2 poles NC, with 230VAC 50/60Hz coil.
- 11BG09T2A46060 for mini-contactor BG09T2, 2 poles NO and 2 poles NC, with 460VAC 60Hz coil.
- Complete the order code with coil voltage digit.
Standard voltages are:
- DC 012 / 024 / 048 / 060 / 110 / 125 / 220V.
The BF18-BF26-BF38 T2D types already have a standard supplied built-in TVS (Transient Voltage Suppressor).
Example:
- 11 BG09T2D012 for mini-contactor BG09T2, 2 poles NO and 2 poles NC, with 12VDC coil.

- Low consumption version with built-in TVS. Complete the order code with coil voltage digit.
Standard voltages are:
- DC 024 / 048V.
Example:
- BF18T2L024 for contactor BF18T2, 2 poles NO and 2 poles NC, with 24VDC low-consumption coil, supplied with TVS.
- The contactor coil is controlled electronically; it can have either an AC or a DC supply and has a wide operating range. Complete the order code with coil voltage digit.
Standard voltages are:
- AC/DC 024 = 20...48V; 110 = 60...110V; 230 = 100...250V.
- For use at this other current value, a 16mm² cable, headed with a fork terminal, must be used.
- Maximum combinations of add-on blocks are given on page 2-19.
- For BF80T2E... contactors, coil supply voltage must be AC or smoothed DC. For pulsating DC please consult our Technical support.

Operational characteristics

Type	UL/CSA General use	Protection fuse		Conductor section	
	[A]	IEC gG [A]	UL K5 [A]	[mm ²]	[AWG]
BG09...T2	20	20	30	0.75-2.5	18-12

Certifications and compliance

Certifications obtained: CCC, EAC; UL Listed, for USA and Canada (cULus - File E93602), as Motor Controllers - Contactors. Compliant with standards: IEC/EN/BS 60947-1, IEC/EN/BS 60947-4-1, UL 60947-4-1, CSA C22.2 n° 60947-1, CSA C22.2 n° 60947-4-1.

Operational characteristics

Type	UL/CSA General use	Protection fuse		Conductor section	
	[A]	IEC gG [A]	UL RK5 [A]	[mm ²]	[AWG]

BF09T2	25	32	60	1-6	16-10
BF18T2	32	40	80	1-6	16-10
BF26T2	45	50	100	1.5-10	14-6
BF38T2	55	80	150	2.5-16	14-6
BF80T2	115	115	250	6-50	18-2

Certifications and compliance

Certifications obtained: EAC, CCC, RINA; UL Listed for USA and Canada (cULus - File E93602) and CSA certified for Canada (File 54332), as Motor Controllers - Contactors. Compliant with standards: IEC/EN/BS 60947-1, IEC/EN/BS 60947-4-1, UL 60947-4-1, CSA C22.2 n° 60947-1, CSA C22.2 n° 60947-4-1. Plastic materials are compliant with standards IEC/EN/BS 60335; for all BF09...BF38 versions only, add suffix V260 to the standard product order code. Example: BF09T2A230 V260 for BF09, 2NO+2NC main poles, 230V 50/60Hz coil with compliant plastic materials).

Operational characteristics

Type	UL/CSA General use	Protection fuse		Conductor section	
	[A]	IEC gG [A]	UL RK5 [A]	[mm ²]	[AWG]

BF18T0	32	40	80	1-6	16-10
BF26T0	45	50	150	1.5-10	14-6

Certifications and compliance

Certifications obtained: EAC, CCC, RINA; UL Listed for USA and Canada (cULus - File E93602) and CSA certified for Canada (File 54332), as Motor Controllers - Contactors. Compliant with standards: IEC/EN/BS 60947-1, IEC/EN/BS 60947-4-1, UL 60947-4-1, CSA C22.2 n° 60947-1, CSA C22.2 n° 60947-4-1. Plastic materials are compliant with standards IEC/EN/BS 60335; for BF18 and BF26 versions only, add suffix V260 to the standard product order code. Example: BF18T0A230V260 for BF18, four NC main poles, 230VAC 50/60Hz coil with compliant plastic materials).

NOTE: The BF18-BF26T0D and BF18T0L types have a standard supplied built-in TVS (Transient Voltage Suppressor).

3 pole contactors to connect in series for photovoltaic applications BF series



BFD6500A - BFD8000A

new

Order code	Operational current at 600V in DC1 ≤55°C with 3 poles in series		Qty per pkg	Wt [kg]
	600V [A]	1000V [A]		
BFD6500A	75	35	1	1,020
BFD8000A	80	60	1	1,020

AC COIL.
Terminals: double lug clamp.

Order code	Operational current at 600V in DC1 ≤55°C with 4 poles in series	Qty per pkg	Wt [kg]
BFD80T4A	100	1	1.100
BFD80T4E	100	1	1.100
BFD150T4E	165	1	2.550

4 pole contactors to connect in series for photovoltaic applications BF series



BFD80T4...



BFD150T4E

AC COIL.
Terminals: double lug-clamp.

Order code	Operational current at 600V in DC1 ≤55°C with 4 poles in series	Qty per pkg	Wt [kg]
BFD80T4A	100	1	1.100
BFD80T4E	100	1	1.100
BFD150T4E	165	1	2.550

AC/DC COIL.
Terminals: double lug-clamp.

Order code	Operational current at 600V in DC1 ≤55°C with 4 poles in series	Qty per pkg	Wt [kg]
BFD80T4A	100	1	1.100
BFD80T4E	100	1	1.100
BFD150T4E	165	1	2.550

- ① Complete with coil voltage digit if 50/60Hz or with voltage digit followed by 60 if 60Hz. Standard voltages are:
 - AC 50/60Hz 024 / 048 / 110 / 230 / 400V
 - AC 60Hz 024 60 / 048 60 / 120 60 / 220 60 / 230 60 / 460 60 / 575 60 (V).
- ② The contactor coil is controlled electronically; it can have either an AC or a DC supply and has a wide operating range. Complete the order code with coil voltage digit. Standard voltages are:
 - AC/DC 024 = 20...48V; 110 = 60...110V; 230 = 100...250V.
- ③ The contactor coil is controlled electronically; it can have either an AC or a DC supply and has a wide operating range. Complete the order code only with the digit of the coil voltage. Standard voltages are:
 - AC/DC 024 = 24...60VAC/20...60VDC; 110 = 60...130VAC/DC; 230 = 100...250VAC/DC; 400 = 250...500VAC/DC.

General characteristics

The contactors are specifically made with magnetic elements in the arc extinction chambers to obtain high DC load operational capabilities. They are used to disconnect and isolate the load between the photovoltaic panel and the AC/DC inverter.

For add-on contact blocks, accessories and spare parts, consider indications of the corresponding standard contactors without the D letter in the code.

Italian Fire Department Directives

These directives provide for a disconnecting device for all current-carrying elements, that can be operated by remote control switch, placed in an easily reached and marked position, in order to safely isolate each part of the installation within the fire system compartment including the photovoltaic (PV) generator.

As an alternative, the PV generator must be installed, either externally of the fire system compartment or internally but in a dedicated compartment with adequate fire-resistant features. For such function, specifically designed contactors for on-load use in IEC DC1 duty up to 1000VDC are available.

Operational characteristics

Use in IEC DC1 duty

Type	Poles in series	IEC operational voltage Ue			
		400V	600V	800V	1000V
		IEC max current Ie in DC1 with L/R ≤1ms with 4 poles in series			
		[A]	[A]	[A]	[A]
BFD6500A...	3	100	75	45	35
BFD8000A...	3	100	80	65	60
BFD80T4A...	4	115	100	90	80
BFD80T4E...	4	115	100	90	80
BFD150T4E...	4	165	165	125	100

Certification and compliance

Compliant with standards: IEC/EN/BS 60947-1, IEC/EN/BS 60947-4-1, UL 60947-4-1, CSA C22.2 n° 60947-1, CSA C22.2 n° 60947-4-1.

Wiring diagrams

Three-pole contactors

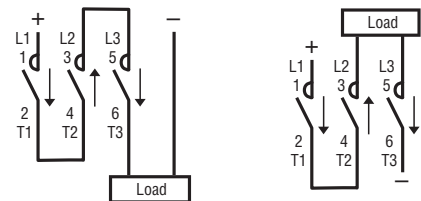

Four-pole contactors

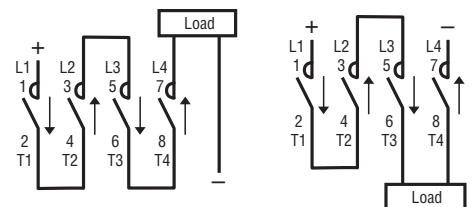

BFK contactors (including limiting resistors)



BFK...

new

Order code	Maximum IEC operational power at ≤50°C (AC-6b) ①				NO	n°	Wt [kg]
	240V	400V	440V	690V			
	[kvar]	[kvar]	[kvar]	[kvar]			
AC COIL							
BFK0910A ②	4.5	7.5	9	10	1	10	0.413
BFK1210A ②	7	12.5	14	16	1	10	0.413
BFK1810A ②	9	15	17	20	1	10	0.413
BFK2600A ②	11	20	22	25	–	10	0.472
BFK3200A ②	14	25	27.5	30	–	10	0.472
BFK3800A ②	17	30	33	36	–	10	0.472
BFK5000A ②	22	40	41	46	–	5	1.080
BFK6500A ②	26	45	50	56	–	5	1.080
BFK8000A ②	30	50	56	65	–	5	1.080
BFK9400A ②④	34	60	75	80	–	5	1.080
BFK9500A ②	34	60	75	80	–	5	2.095
BFK11500A ②	45	75	85	135	–	5	2.095
BFK15000A ②	50	100	115	150	–	5	2.095

- ① To use the contactor in the delta, consult our Technical support, see contact details on inside front cover..
- ② NO auxiliary contacts available.
- ③ The order code must be completed either with the coil voltage digit if 50/60Hz or with the coil voltage digit followed by the number 60 if 60Hz. Standard voltages are:
 – AC 50-60Hz 024 / 048 / 110 / 230 / 400VAC
 – AC 60Hz 024 60 / 048 60 / 120 60 / 220 60 / 230 60 / 460 60 / 575 60 (V).
 Example: BFK0910A230 for contactor BFK09 with one NO contact and 230VAC 50/60Hz coil.
 BFK0910A46060 for contactor BFK09 with one NO contact and 460VAC 60Hz coil.
- ④ **NOTE: the maximum thermal current Ith of the BFK94 contactor is 115A.**

UL/CSA details
Maximum UL/CSA kvar ratings

	240V	480V	600V
	kVAR	kVAR	kVAR
BFK0910A	4.5	9	10
BFK1210A	7	14	16
BFK1810A	9	17	20
BFK2600A	11	22	27.5
BFK3200A	14	27.5	32
BFK3800A	17	33	36
BFK5000A	22	41	46
BFK6500A	26	50	56
BFK8000A	30	60	75
BFK9500A	40	80	100
BFK11500A	45	90	120
BFK15000A	50	100	125

Kit to assemble BFK contactors

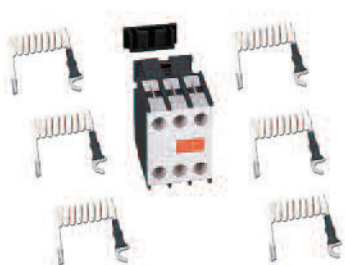

11G46...

Order code	For contactor	Qty per pkg	Wt
		n°	[kg]
11G460	BF0910A - BF1210A - BF1810A - BF2600A - BF3200A - BF3800A	1	0.072
BFX10K3	BF5000A - BF6500A - BF8000A - BF9400A	1	0.078
BFX10K4	BF9500A - BF11500A - BF15000A	1	0.080

Operational characteristics

Type	IEC rated operational current ≤440V [A]	IEC - UL/CSA protection fuse gG-SC [A]
BFK09	12	16
BFK12	18	25
BFK18	23	40
BFK26	30	40
BFK32	36	63
BFK38	43	63
BFK50	58	80
BFK65	65	100
BFK80	75	125
BFK94	90	125
BFK95	90	125
BFK115	115	160
BFK150	144	160

Ambient operating temperature: ≤50°C. For ambient temperatures higher than 50°C and up to 70°C, the maximum operating power values indicated in the table must be reduced by a percentage equal to the difference between the operating ambient temperature and 50°C.
 E.g.: using a BFK2600 contactor at the ambient temperature of 60°C, the maximum operating power (at 400V) of the contactor will be equal to 20kvar – 10% = 18kvar.
 Operating cycle: ≤120 cycles/h
 Electrical life: ≥400,000 cycles.

Add-on auxiliary contacts

The following contact blocks, can be fitted on the BFK contactors: BFX12..., 11G418..., 11G481..., 11G482... and 11G218.

Certifications and compliance

Certification obtained (BFK9400A excluded):UL Listed for USA and Canada (cULus - File E93602), as Motor Controllers - Magnetic Capacitive Switches; CCC, EAC.
 Compliant with standards: IEC/EN/BS 60947-1, IEC/EN/BS 60947-4-1, UL508, CSA C22.2 n° 14.
 Plastic materials are compliant with standards IEC/EN/BS 60335; for BFK versions only, add suffix V260 to the standard product order code.

General characteristics

To optimise contactor stock management, a kit is available to transform normal three-pole contactors into BFK types for power factor correction. The table to the left indicates which kits to purchase depending on the standard contactor in stock.

Control relays BG00 type



11BG00...

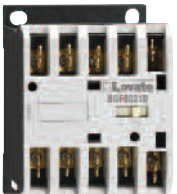

11BF00...

Control relays BF00 type



BF00...A...



BF00...D...
BF00...L...

Order code	Configuration and n° of contacts ⑤		Quantity per pkg. n°	Wt [kg]
	NO	NC		
AC COIL. Terminals: clamp screw.				
11BG0040A①	4	0	1	0.170
11BG0031A①	3	1	1	0.170
11BG0022A①	2	2	1	0.170
Terminals: Faston.				
11BGF0040A①	4	0	1	0.160
11BGF0031A①	3	1	1	0.160
11BGF0022A①	2	2	1	0.160
DC COIL. Terminals: clamp screw.				
11BG0040D②	4	0	1	0.175
11BG0031D②	3	1	1	0.175
11BG0022D②⑥	2	2	1	0.175
Terminals: Faston.				
11BGF0040D②	4	0	1	0.165
11BGF0031D②	3	1	1	0.165
11BGF0022D②	2	2	1	0.165
DC COIL. Low-consumption (2.3W). Terminals: clamp screw ⑦.				
11BG0040L③	4	0	1	0.175
11BG0031L③	3	1	1	0.175
11BG0022L③	2	2	1	0.175
Terminals: Faston.				
11BGF0040L③	4	0	1	0.165
11BGF0031L③	3	1	1	0.165
11BGF0022L③	2	2	1	0.165

Order code	Configuration and n° of contacts ⑤		Quantity per pkg. n°	Wt [kg]
	NO	NC		
AC COIL. Terminals: clamp screw.				
BF0040A①	4	0	1	0.340
BF0031A①	3	1	1	0.340
BF0022A①	2	2	1	0.340
BF0004A①	0	4	1	0.340
DC COIL. Terminals: clamp screw.				
BF0040D②⑥	4	0	1	0.470
BF0031D②⑥	3	1	1	0.470
BF0022D②⑥	2	2	1	0.470
BF0004D②⑥	0	4	1	0.470
DC COIL. Low consumption (2.4W). Terminals: clamp screw.				
BF0040L③⑥	4	0	1	0.470
BF0031L③⑥	3	1	1	0.470
BF0022L③⑥	2	2	1	0.470
BF0004L③⑥	0	4	1	0.470

- ① The order code must be completed either with the coil voltage digit if 50/60Hz or with the coil voltage digit followed by the number 60 if 60Hz. Standard voltages are:
 - AC 50/60Hz 024 / 048 / 110 - 230 / 400V
 - AC 60Hz 024 60 / 048 60 / - 120 60 / 220 60 / 230 60 / 460 60 / 575 60 (V).
 Example: 11BG0040A230 (auxiliary mini-contactor 4 NO auxiliary contacts supplied at 230VAC 50/60Hz).
 BF0040A46060 (auxiliary contactor with 4 NO auxiliary contacts supplied at 460VAC 60Hz).
- ② Complete the order code with coil voltage digit. Standard voltages are:
 - DC 012 / 024 / 048 / 060 / 110 / 125 / 220V.
 Example: BF0040D012 (auxiliary contactor with 4 NO auxiliary contacts supplied at 12VDC).
- ③ Low-consumption version. Complete the order code with coil voltage digit. Standard voltages are:
 - DC 024 / 048V.
 Example: 11BG0040L024 (low-consumption auxiliary mini-contactor with 4 NO auxiliary contacts supplied at 24VDC).
- ④ Maximum combinations of add-on blocks are given on page 2-19.
- ⑤ All contacts are highly conductive.
- ⑥ On 11BG0022D, maximum 2 auxiliary contacts may be mounted.
- ⑦ Auxiliary contact blocks and mechanical interlock cannot be mounted.

Operational characteristics

- IEC rated insulation voltage U_i : 690V
- IEC rated conventional free air thermal current I_{th} : 10A
- UL/CSA and IEC/EN/BS 60947-5-1 designation:
 - BG types: A600-Q600
 - BF types: A600-P600
- Low-consumption version of BG types cannot accept additional contacts.

NOTE: no coil change or replacement is possible.

Certifications and compliance

Certification obtained: CCC, EAC, UL Listed for USA and Canada (cULus - File E93602), as Motor Controllers - Auxiliary contactors for all; RINA for BF00 types. Compliant with standards: IEC/EN/BS 60947-1, IEC/EN/BS 60947-5-1, UL 60947-4-1, CSA C22.2 n° 60947-1, CSA C22.2 n° 60947-4-1. Plastic materials are compliant with standards IEC/EN/BS 60335; for BF00 version only, add suffix V260 to the standard product order code. Example: BF0040A230V260 for BF00 control relay having 4 NO auxiliary contacts and 230VAC 50/60Hz coil with compliant plastic materials.

NOTE: the BF00...D and BF00...L types have a standard supplied built-in TVS (Transient Voltage Suppressor).

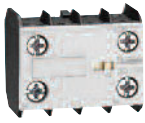

11BGX10... (20-11-02)
11BGX1111



11BGX10... (40-31-22-13-04)
11BGX1122

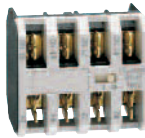

11BGXF...



11BGX77... -
11BGX78225 -
11BGX79...



11BGX5000

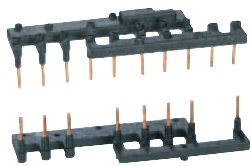

11SMX9021
11SMX9022

Order code	Characteristics	Max qty per contactor	Qty per pkg	Wt
		n°	n°	[kg]

Auxiliary contacts.
Screw terminals.

11BGX1002①	2NC	1	10	0.021
11BGX1011①	1NO + 1NC	1	10	0.021
11BGX1020①	2NO	1	10	0.021
11BGX1004②	4NC	1	10	0.028
11BGX1013②	1NO + 3NC	1	10	0.028
11BGX1022②	2NO + 2NC	1	10	0.028
11BGX1031③	3NO + 1NC	1	10	0.028
11BGX1040③	4NO	1	10	0.028

Auxiliary contacts for reversing and changeover assemblies.
Screw terminals.

11BGX1111④	1NO + 1NC	1	10	0.021
11BGX1122④	2NO + 2NC	1	10	0.028

Auxiliary contacts.
Faston terminals.

11BGXF1002⑤	2NC	1	10	0.021
11BGXF1011⑤	1NO + 1NC	1	10	0.021
11BGXF1020⑤	2NO	1	10	0.021
11BGXF1004⑥	4NC	1	10	0.028
11BGXF1013⑥	1NO + 3NC	1	10	0.028
11BGXF1022⑥	2NO + 2NC	1	10	0.028
11BGXF1031⑦	3NO + 1NC	1	10	0.028
11BGXF1040⑦	4NO	1	10	0.028

Mechanical interlock.

11BGX5000⑧	For BG...A and BG...D	1	10	0.008
------------	-----------------------	---	----	-------

Quick connect surge suppressors.

11BGX77048	≤48VAC/DC (Varistor)	10	0.007
11BGX77125	48...125VAC/DC (Varistor)	10	0.007
11BGX77240	125...240VAC/DC (Varistor)	10	0.007
11BGX78225	≤225VDC (Diode)	10	0.007
11BGX79048	≤48VAC (Resistor-Capacitor)	10	0.007
11BGX79125	48...125VAC (Resistor-Capacitor)	10	0.007
11BGX79240	125...240VAC (Resistor-Capacitor)	10	0.007
11BGX79415	240...415VAC (Resistor-Capacitor)	10	0.007

Modular shroud.

11BGX8000⑨	IP40 front protection	20	0.006
------------	-----------------------	----	-------

Paralleling links.

11G323⑩	For 2 poles	10	0.009
11G324		10	0.009
11G325⑩	For 4 poles	10	0.014
11G326		10	0.014

Rigid connecting kits.

11SMX9021⑪	Rigid connections for star-delta starter with BG... mini-contactors	10	0.040
11SMX9022⑪	Rigid connections for reversing switches with BG... mini-contactors	1	0.026

- ① Cannot be used with BG...L types.
- ② Cannot be used with BG...D and BG...L types.
- ③ Suitable for left-hand mini-contactor only of BGT and BGTP reversing and BGC changeover assemblies.
- ④ The shroud can be used with BG... types with screw termination only and with no auxiliary contacts, surge suppressor or mechanical interlock mounted. It raises the front degree of protection of the mini-contactor when these are used in consumer switchboards.
- ⑤ Cannot be used with BGX8000 shroud.
- ⑥ Contactors with one NC auxiliary contact, 01 type, are usually used. The SM1 breaker can be directly fitted with rigid connector; type connection SM1X3040P for SM1P... breaker and connection SM1X3040R for SM1R... breaker. The relay cannot be directly mounted on the contactor. Use the RF38 type and the RFX3804 independent mounting base.

Operational characteristics

Type		BGX10... BGX11...	BGXF10...
IEC rated conventional free air thermal current Ith	A	10	10
IEC rated insulation voltage Ui	V	690	690
Terminals	Screw	M3	Faston 1x6.3mm 2x2.8mm
	Width	mm	6.9
Tightening torque	Nm	0.8...1	—
	lb.in	7...9	—
Conductor section maximum (with 1 or 2 cables)	flexible without lug	mm ²	2.5
		mm ²	2.5
	AWG	n°	14
		n°	14
UL/CSA and IEC/EN/BS 60947-5-1 designation	AC	A600	A600
	DC	Q600	Q600
Mechanical life (million)	cycles	20	20

SM1 breaker - mini-contactor connecting kit

See page 1-12.

Certifications and compliance

Certifications obtained:

Type	UL	cULus	EAC	CCC
BGX10...	—	●	●	●
BGX11...	—	●	●	●
BGXF10...	—	●	●	—
BGX5000	—	●	●	—
BGX7...	—	●	●	—
BGX8000	—	—	●	—
G32...	—	—	●	—
SMX90...	UL	—	—	—

● Certified products;

- UL - UL Recognized for USA only (File E197069) as Panel and Switchboard Accessories - Component. Products having this type of marking are intended for use as components of complete workshop-assembled equipment.
- cULus - UL Listed for USA and Canada (cULus - File E93601) as Auxiliary Devices - Component.

Compliant with standards: UL 60947-4-1, CSA C22.2 n° 60947-1, CSA C22.2 n° 60947-4-1; IEC/EN/BS 60947-1; IEC/EN/BS 60947-5-1 for auxiliary contacts.

The add-on auxiliary contact blocks 11BGX... and 11BGXF... comply with annex F of the IEC/EN/BS 60947-4-1 standard "auxiliary contact linked with power contact" also known as mirror contact. They also comply with Annex L of the IEC/EN/BS 60947-5-1 standard "mechanically linked contact elements".

Combinations: mounting position on BG...A and BG...D mini-contactors

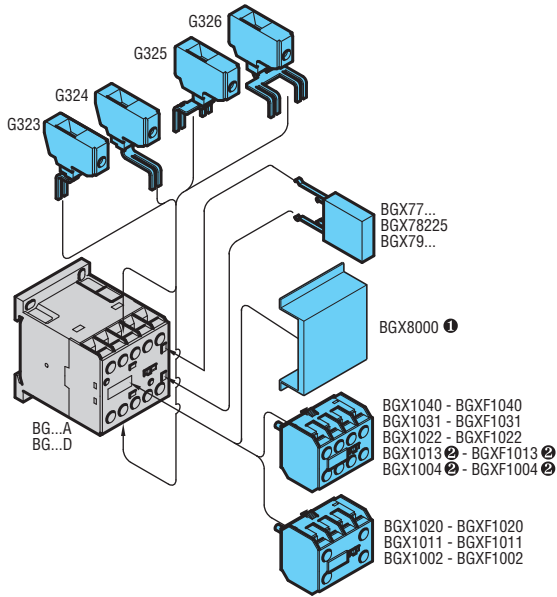

- ❶ Not suitable for mini-contactors BG... with auxiliaries contacts BGX10..., surge suppressor BGX7... and interlock BGX5000.
- ❷ Not suitable for BG...D types.

Combinations: mounting position on BG...L mini-contactors

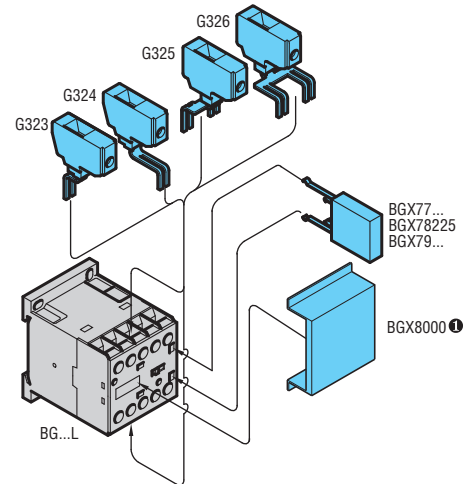

Combinations for reversing and changeover contactors assembled with BG...A and BG...D types

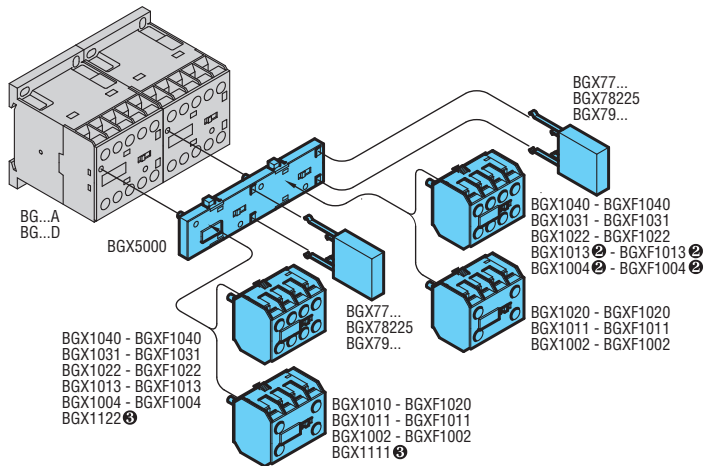

- ❷ Not suitable for BG...D types.
- ❸ For left-hand mini-contactor of BGT, BGTP and BGC contactor assemblies only. See page 4-5.

Connections for reversing contactor assembly

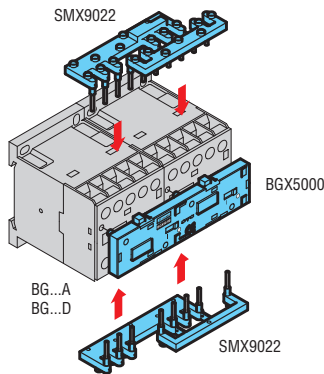

Connections for star-delta assembly

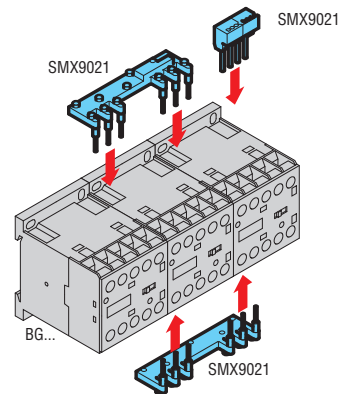



BFX10...



11G484...



BFX10...



11G418...

11G218



11G481...
11G482

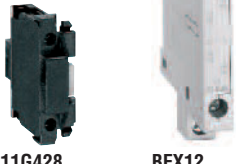

11G428...

BFX12...



11G485...
11G486...
11G487

- ❶ The contacts can also be fitted on B type contactors using the adapter G358. See pages 2-30 and 2-31.
- ❷ Highly conductive contacts.
- ❸ Normally closed late-break contact.
- ❹ Normally open early-make contact.
- ❺ Gold-plated contacts inside tight casing for use in pollutant environments. The Ith value refers to 125VAC and 30VDC. Minimum applicable load: 5VDC 1mA. IEC IP20 protection is warranted to equipment wired with insulated Faston terminals.
- ❻ IEC IP20 protection is warranted to equipment wired with minimum 0.75mm² conductor section. Designation in DC is Q600 for G418 and G419 types.
- ❼ IEC IP20 protection is warranted to equipment wired with insulated Faston terminals.
- ❽ IEC IP20 protection is warranted to equipment wired with minimum 1mm² conductor section. Mechanical life is 3 million cycles.
- ❾ 1.5mm² for insulated bootlace ferrules.

Order code	Characteristics	Max qty per cont.	Qty per pkg.	Wt [kg]
		n°	n°	[kg]

Auxiliary contacts with front center mounting ❷. Screw terminals.

BFX1002 ❶	2NC	1	5	0.030
BFX1011 ❶	1NO + 1NC	1	5	0.030
BFX1020 ❶	2NO	1	5	0.030
11G48403 ❶	3NC	1	5	0.039
11G48412 ❶	1NO + 2NC	1	5	0.039
11G48421 ❶	2NO + 1NC	1	5	0.039
11G48430 ❶	3NO	1	5	0.039
BFX1004	4NC	1	5	0.048
BFX1013	1NO + 3NC	1	5	0.048
BFX1022	2NO + 2NC	1	5	0.048
BFX1031	3NO + 1NC	1	5	0.048
BFX1040	4NO	1	5	0.048
BFX101111	1NO+1NC and 1EM❶+1LB❶	1	5	0.048

Auxiliary contacts with front lateral mounting. Screw terminals❶.

11G41801	1NC	2	10	0.014
11G41801D	1LB❶	2	10	0.014
11G41810	1NO	2	10	0.014
11G41810A	1EM❶	2	10	0.014

Auxiliary contacts with front lateral mounting. Faston terminals❶.

11G218	1NO or 1NC reversible	2	10	0.011
11G48102	2NC	2	10	0.013
11G48111	1NO + 1NC	2	10	0.013
11G48120	2NO	2	10	0.013
11G482 ❶❷	Changeover contact	2	10	0.013

Adapter for auxiliary contact side mounting.

11G280	for G218	2	10	0.008
11G419	for G418	2	10	0.010
11G483	for G481 and G482	2	10	0.010

Auxiliary contacts with low side mounting. Screw terminals.

BFX1202 ❶	2NC	2	5	0.044
BFX1211 ❶	1NO+1NC	2	5	0.044
BFX1220 ❶	2NO	2	5	0.044
11G42801	1NC	2	10	0.024
11G42801D	1LB❶	2	10	0.024
11G42810	1NO	2	10	0.024
11G42810A	1EM❶	2	10	0.024

Delayed auxiliary contacts 1NO + 1NC (pneumatic operation) on energisation for front center mounting ❶❷. Screw terminals.

11G4853	3s	1	1	0.040
11G4856	6s	1	1	0.040
11G48515	15s	1	5	0.040
11G48530	30s	1	5	0.040
11G48560	60s	1	5	0.040
11G485120	120s	1	1	0.040

Delayed auxiliary contacts 1NO + 1NC (pneumatic operation) on de-energisation for front center mounting ❶❷. Screw terminals.

11G4863	3s	1	1	0.040
11G4866	6s	1	1	0.040
11G48615	15s	1	5	0.040
11G48630	30s	1	5	0.040
11G48660	60s	1	5	0.040
11G486120	120s	1	1	0.040
11G487	70ms	1	1	0.040

Operational characteristics for add-on auxiliary contacts

Type		G418❶ G428❶ G485❶ G486❶ G487❶	G484 BFX10 BFX12	G218❷ G481❷	G482❶
IEC conventional free air thermal current Ith	A	10	10	10	0.1❶
IEC rated insulation voltage Ui	V	690	690	690	690
Terminals	Screw	M3.5	M3	—	—
	Width	mm	7	7	—
	Faston	—	—	1x6.35 2x2.8	1x6.35 2x2.8
Tightening torque	Nm	0.8...1	0.8...1	—	—
	lb.in	7...9	7...9	—	—
	Conductor section maximum with (1 or 2 cables)				
flexible w/o lug	mm ²	2.5	2.5	—	—
flexible c/w lug	mm ²	2.5	2.5❶	2.5	2.5
AWG	n°	14	14	14	14
Terminal protection per IEC/EN/BS 60529	AC	IP20 ❶❷	IP20	IP20❷	IP20❶
	DC	A600 P600❶	A600 Q600	A600 P600	A600 P600
Mechanical life (million)	cycles	10❶	10	10	10

SM1 breaker - contactor connecting kit

See page 1-12.

Maximum assembly combination of add-on blocks

See pages 2-21 and 2-24...25.

Certifications and compliance

Certifications obtained:

Type	UL	cULus	CSA	EAC	CCC
BFX10...	—	●	—	●	●
BFX12...	—	●	—	●	—
G218	❶	—	●	●	—
G418..., G428...	❶	—	●	●	—
G481...	❶	—	●	●	—
G482	❶	—	●	●	—
G484...	❶	—	●	●	—
G485...	❶	—	●	●	—
G486...	❶	—	●	●	—
G487...	❶	—	●	●	—

- Certified products; pending for BFX101111
- ❶ - UL Recognized for USA only (File E93601) as Auxiliary Devices - Component. Products having this type of marking are intended for use as components of complete workshop-assembled equipment.
- cULus - UL Listed for USA and Canada (cULus - File E93601) as Auxiliary Devices.
- CSA - CSA certified for Canada only (File 54332) as Auxiliary Devices for motor controllers.

Add-on auxiliary contacts are compliant with the following standards: IEC/EN/BS 60947-1, IEC/EN/BS 60947-5-1, UL 60947-1, UL 60947-5-1, CSA C22.2 n° 60947-1, CSA C22.2 n° 60947-5-1.

The add-on auxiliary contact blocks BFX10... (BFX101111 excluded) and BFX12... comply with annex F of the IEC/EN/BS 60947-4-1 standard "auxiliary contact linked with power contact" also known as mirror contact. They also comply with Annex L of the IEC/EN/BS 60947-5-1 standard "mechanically linked contact elements".

For the BF40...BF150 contactors, compliance with Annex L of the IEC/EN/BS 60947-5-1 standard applies only to the versions with electronically controlled AC/DC coil.

2 Contactors

Add-on blocks and accessories for contactors BF00, BF09...BF150

BF00A, BF09A...BF150A, BF40E...BF150E

Maximum assembly combination for alternating-current contactors BF00A, BF09A...BF150.
Maximum assembly combination for alternating/direct-current contactors BF40E...BF150E.

		Front centre mount				Front lateral mount			Side mount			
		n° of blocks 1 type only			n° of blocks	n° of blocks 1 type only		n° of blocks	n° of blocks	n° of blocks		
Contactors	Control relay	BF00A	1	1	1	1	—	1	2	1	1	
	Three poles	BF09A...BF25A	1	1	1	1	—	—	1	2	1	1
		BF26A...BF38A	1	1	1	1	—	—	1	2	1	1
		BF40A...BF150A	1	1	1	1	1	—	1	2	1	1
		BF40E...BF150E	1	1	1	1	—	1	1	2	1	1
	Four poles	BF09A...BF25A	1	1	1	1	1	—	1	2	1	1
		BF26A...BF38A	1	1	1	1	1	—	1	2	1	1
		BF40A...BF150A	1	1	1	1	—	1	1	2	1	1
		BF40E...BF150E	1	1	1	1	—	1	1	2	1	1

- ① Cannot be fitted with BFX10... with 4 contacts and G222.
- ② To fit the mechanical interlock, the add-on fourth pole needs to be mounted on the left side of the one of the contactors.
- ③ One only side-mount block can be fitted on each contactor whenever the BFX500... interlock is mounted.
- ④ One BFX10... or delayed G48... contact block can be mounted on the G222, G272 or BFX641 mechanical latch.
- ⑤ G222 mechanical latch.
- ⑥ G272 mechanical latch for BF40...BF80; BFX641 for BF95...BF150.
- ⑦ For BF40...BF94 code BFX5300 or BFX5301; for BF95...BF150 code BFX5400 or BFX5401.
- ⑧ BFX5303 for BF40...BF94; BFX5403 for BF95...BF150.
- ⑨ BFX5303 cannot be mounted if a contact block BFX10... with 4 contacts (BFX1004, BFX1013, BFX1022, BFX1031, BFX1040) is installed.

BF00D, BF09D...BF38D, BF00L, BF09L...BF38L

Maximum assembly combination for direct-current contactors BF00D, BF09D...BF38D
Maximum assembly combination for direct-current contactors BF00L, BF09L...BF38L with low consumption

		Front centre mount				Front lateral mount		Side mount		
		n° of blocks 1 type only			n° of blocks	n° of blocks 1 type only		n° of blocks	n° of blocks	
Contactors	Control relay	BF00D	1	1	1	1	—	1	1	
		BF00L	1	—	1	—	—	—	—	
	Three poles	BF09D-BF25D	1	1	1	1	—	—	1	1
		BF26D-BF38D	1	1	1	1	—	—	1	1
		BF09L-BF25L	1	—	1	—	—	—	—	—
		BF26L-BF38L	1	—	1	—	—	—	—	—
	Four poles	BF09D-BF25D	1	1	1	1	1	—	1	1
		BF26D-BF38D	—	1	—	—	—	—	1	1
		BF09L-BF25L	1	—	1	—	—	—	—	—
		BF26L-BF38L	—	1	—	—	—	—	—	—

- ① Mounting of BFX5003 interlock is not possible when BFX10... block with 4 contacts and G222 latch are mounted.
 - ② One only side-mount block can be fitted on each contactor whenever the BFX500... interlock is mounted.
 - ③ One BFX10... or delayed G48... contact block can be mounted on the G222 or G272 mechanical latch.
 - ④ To fit the mechanical interlock, the add-on fourth pole needs to be mounted on the left side of the one of the contactors.
- For other assembly combination, consult Technical support (E-mail: service@LovatoElectric.com).



BFX42
BFXD42



BFX5000
BFX5300
BFX5400

BFX5001
BFX5301
BFX5401



BFX5002

BFX5003
BFX5303
BFX5403



11G222...
11G272...
BFX641...



11G454
11G455
BFX642



BFX77...
BFX79...

Order code	Characteristics	Max qty per cont.	Qty per pkg	Wt [kg]
		n°	n°	[kg]
Fourth pole.				
BFX42	For BF26A, BF32A, BF38A	1	1	0.100
BFXD42	For BF26D, BF32D, BF38D, BF26L, BF32L, BF38L	1	1	0.108
BFX43	For BF40A...BF94A and BF40E...BF94E	1	1	0.150
BFX44	For BF95A...BF150A and BF95E...BF150E	1	1	0.500

Mechanical interlock.				
BFX5000	Side mount for BF00, BF09...BF38	1	5	0.039
BFX5001	Side mount with 2NC contacts for BF00, BF09...BF38	1	5	0.052
BFX5002	Front mount, low profile for BF00, BF09...BF38	1	5	0.006
BFX5003	Front mount for BF00, BF09...BF38	1	5	0.023
BFX8910	Spacer for interlocking BF09...BF38 AC/DC with types in DC	1	10	0.017
BFX5300	Side mount for BF40...BF94 A/E	1	5	0.039
BFX5301	Side mount with 2NC contacts for BF40...BF94 A/E	1	5	0.052
BFX5303	Front mount for BF40...BF94 A/E	1	5	0.034
BFX5400	Side mount for BF95...BF150 A/E	1	5	0.039
BFX5401	Side mount with 2NC contacts for BF95...BF150 A/E	1	5	0.052
BFX5403	Front mount for BF95...BF150 A/E	1	5	0.034

Mechanical latch. Screw terminals				
11G222	For BF00, BF09...BF38	1	1	0.070
11G272	For BF40...BF94	1	1	0.070
BFX641...	For BF95...BF150	1	1	0.070
Manual closing mechanism.				
11G454	For BF00, BF09...BF38	1	1	0.021
11G455	For BF40...BF94	1	1	0.021
BFX642	For BF95...BF150	1	1	0.021

Quick connect surge suppressors for BF00A, BF09A...BF150A contactors.				
BFX77048	≤48VAC/DC (Varistor)	5	0.012	
BFX77125	48...125VAC/DC (Varistor)	5	0.012	
BFX77240	125...240VAC/DC (Varistor)	5	0.012	
BFX79048	≤48VAC (Resistor-Capacitor)	5	0.012	
BFX79125	48...125VAC (Resistor-Capacitor)	5	0.012	
BFX79240	125...240VAC (Resistor-Capacitor)	5	0.012	
BFX79415	240...415VAC (Resistor-Capacitor)	5	0.012	

- ① Different sized contactors can be interlocked. Example: BF09...BF25 with BF26...BF38.
 - ② Replace with the digit of the voltage if 50 or 60Hz and with the letter C followed by the digit of the voltage if DC. Standard voltages are:
 - AC 50/60Hz 24 (indicate 24) - 48 (indicate 48) - 110...125 (indicate 110) - 220...240 (indicate 220) - 380...415V (indicate 380) - 12 (indicate 12) - 24 (indicate 24) - 48 (indicate 48) - 110...125 (indicate 110) - 220...240V (indicate 220).
 - DC
- NOTE: All contactors BF series, equipped with DC or AC/DC electronic coil, have built-in surge suppressor filter.

Operational characteristics

Type		BFX42 BFXD42	BFX43	BFX44	BFX5001 BFX5301 BFX5401
IEC conventional free air thermal current Ith	A	56	115	165	10
IEC rated insulation voltage Ui	V	690	1000	1000	690
Terminals: Screw		M4	M6	M8	M3
Width	mm	12.5	9.6	14.5	7
Tightening torque	Nm	2.5...3	4...5	5.5...6.5	0.8...1
	lb.in	21.6...26.4	35.4...44.2	48...57	7...9
Conductor section maximum with 1 or 2 cables					
flexible w/o lug	mm ²	16	35	70	2.5
flexible c/w lug	mm ²	16	35	70	2.5
AWG	n°	6	2	2/0	14
Terminal protection for IEC/EN/BS 60529		IP20	IP20	IP20	IP20
UL/CSA and IEC/EN/BS 60947-5-1 designation	AC	—	—	—	A600
	DC	—	—	—	Q600
Mechanical life (million)	cycles	20	15	15	10

Type		G222...	G272...	BFX641	
Rated control circuit voltage	AC (50/60Hz)	V	24...415	24...415	24...415
	DC	V	12...240	12...240	12...240
Power consumption with control:	AC	VA	40	40	40
	DC	W	70	70	70
Minimum energising:					
drop-out	ms	10	10	10	
pick-up	ms	100	200	200	
Tightening torque	Nm	0.8...1	0.8...1	0.8...1	
	lb.in	7...9	7...9	7...9	
Conductor section Maximum with 1 or 2 cables					
flexible w/o lug	mm ²	4	4	4	
flexible c/w lug	mm ²	2.5	2.5	2.5	
AWG	n°	14...12	14...12	14...12	
Mechanical life (million)	cycles	0.1	0.1	0.01	

③ The condition is front IP20 protection.

Maximum assembly combination of add-on blocks

See pages 2-21, 2-24...25.

Certifications and compliance

Certifications obtained:

Type	UL	cULus	CSA	EAC
BFX42 - BFXD42 - BFXD43	—	●	—	●
BFX5...	—	●	—	●
BFX77... - BFX79...	—	●	—	●
G222... - G272... - BFX641	UL	—	●	●

● Certified products.

UL - UL Recognized for USA only (File E93601) as Auxiliary Devices Component.

Products having this type of marking are intended for use as components of complete workshop-assembled equipment.

cULus - UL Listed for USA and Canada (cULus - File E93602) as Magnetic motor controllers.

CSA - CSA certified for Canada only (File 54332) as Auxiliary Devices for motor controllers.

Compliant with standards: IEC/EN/BS 60947-1, UL 60947-1, CSA C22.2 n° 60947-1. IEC/EN/BS 60947-5-1, UL 60947-5-1, CSA C22.2 n° 60947-5-1 for auxiliary contacts IEC/EN/BS 60947-4-1, UL 60947-4-1, CSA C22.2 n° 60947-4-1 for four poles.

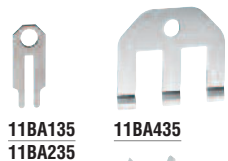
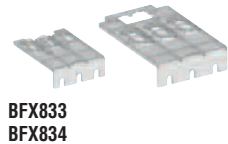
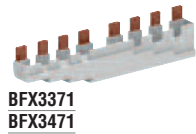
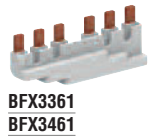
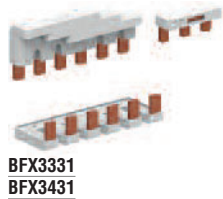
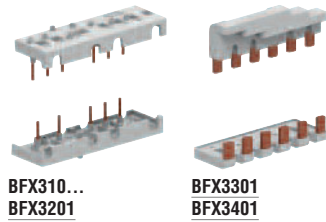

Order code	Characteristics	Qty per pkg	Wt [kg]
		n°	[kg]
Rigid connecting kits for three-pole reversing contactor assembly.			
BFX3101	For contactors BF09...BF25 side by side with BFX5002 or BFX5003 mechanical interlock	1	0.052
BFX3102	For contactors BF09...BF25 side by side with BFX5000 or BFX5001 mechanical interlock	1	0.054
BFX3201	For contactors BF26...BF38 side by side with BFX50... mechanical interlock	1	0.060
BFX3301	For contactors BF40...BF94 side by side with BFX5303 mechanical interlock	1	0.150
BFX3401	For contactors BF95...BF150 side by side with BFX5403 mechanical interlock	1	0.200
Rigid connecting kits for star-delta starters.			
BFX3131	For contactors BF09...BF25	1	0.058
BFX3231	For contactors BF26...BF38	1	0.064
BFX3232	For contactors BF26...BF38 (L/Δ) BF09...BF25 (Λ)	1	0.064
BFX3332	For contactors BF40...BF94 (L/Δ) BF26...BF38 (Λ)	1	0.200
BFX3331	For contactors BF40...BF94	1	0.220
BFX3432	For contactors BF95...BF150 (L/Δ) BF40...BF94 (Λ)	1	0.250
BFX3431	For contactors BF95...BF150	1	0.270
Rigid connecting kits for changeovers.			
BFX3361	For three pole contactors BF40...BF94 with BFX5300/BFX5301 mechanical interlock	1	0.150
BFX3461	For three pole contactors BF95...BF150 with BFX5400/BFX5401 mechanical interlock	1	0.200
BFX3371	For four pole contactors BF40...BF80 with BFX5300/BFX5301 mechanical interlock	1	0.200
BFX3471	For four pole contactors BF95...BF150 with BFX5400/BFX5401 mechanical interlock	1	0.300
IP20 protection for power terminals. 2 pieces for each contactor are required.			
BFX833	For three pole contactors BF40...BF94	10	0.020
BFX834	For three pole contactors BF95...BF150	10	0.030
Non insulated paralleling links.			
11BA135	2 poles for contactors BF09...BF25 types	10	0.001
11BA235	2 poles for contactors BF26...BF38 types	10	0.003
BFX3392	2 poles for contactors BF40...BF94 types	4	0.022
BFX3492	2 poles for contactors BF95...BF150 types	4	0.027
BFX3393	3 poles for contactors BF40...BF94 types	4	0.038
11BA435	3 poles for contactors BF95...BF150 types	10	0.030
Insulated paralleling link with terminal.			
BFX3399	3 pole (for contactors BF40...BF94) Conductor section connectable: 25...95mm ² (95mm ² without lug)	10	0.135
One-pole enlarged terminals.			
11G231	1x6mm ² for contactors BF09...BF25 types	12	0.009
11G232	1x16mm ² for contactors BF26...BF38 types	12	0.014
Sealing cover.			
BFX80	Sealing cover for contactors BF00 and BF09...BF38	10	0.001
Screw fixing adapters for contactors.			
BFX8901	Universal base to screw fix BF09...BF38 contactors	5	0.016
BFX8902	Screw fixing brackets for BF09...BF38 contactors	10	0.002
Marking element for BF00, BF09...BF150 contactors.			
BFX30	Blank label for writing	50	0.001

Operational characteristics

Type		BFX3399	11G231	11G232
Tightening torque	Nm	13Nm	1.5-1.8	2.5-3
	lb.in	115	13.2-18	7-9
Tool	Type	Allen key 6	PH1	PH2

Certifications and compliance

Certifications obtained: UL Listed for USA and Canada (cULus - File E93602), for all connecting kits for starters and changeovers BFX3...; EAC.
Compliant with standards: IEC/EN/BS 60947-1, UL 60947-1, CSA C22.2 n° 60947-1.

Add-on blocks for AC and AC/DC contactors

Combinations: mounting position on BF00A and BF09A...BF150A contactors
Table with combinations: See page 2-21.

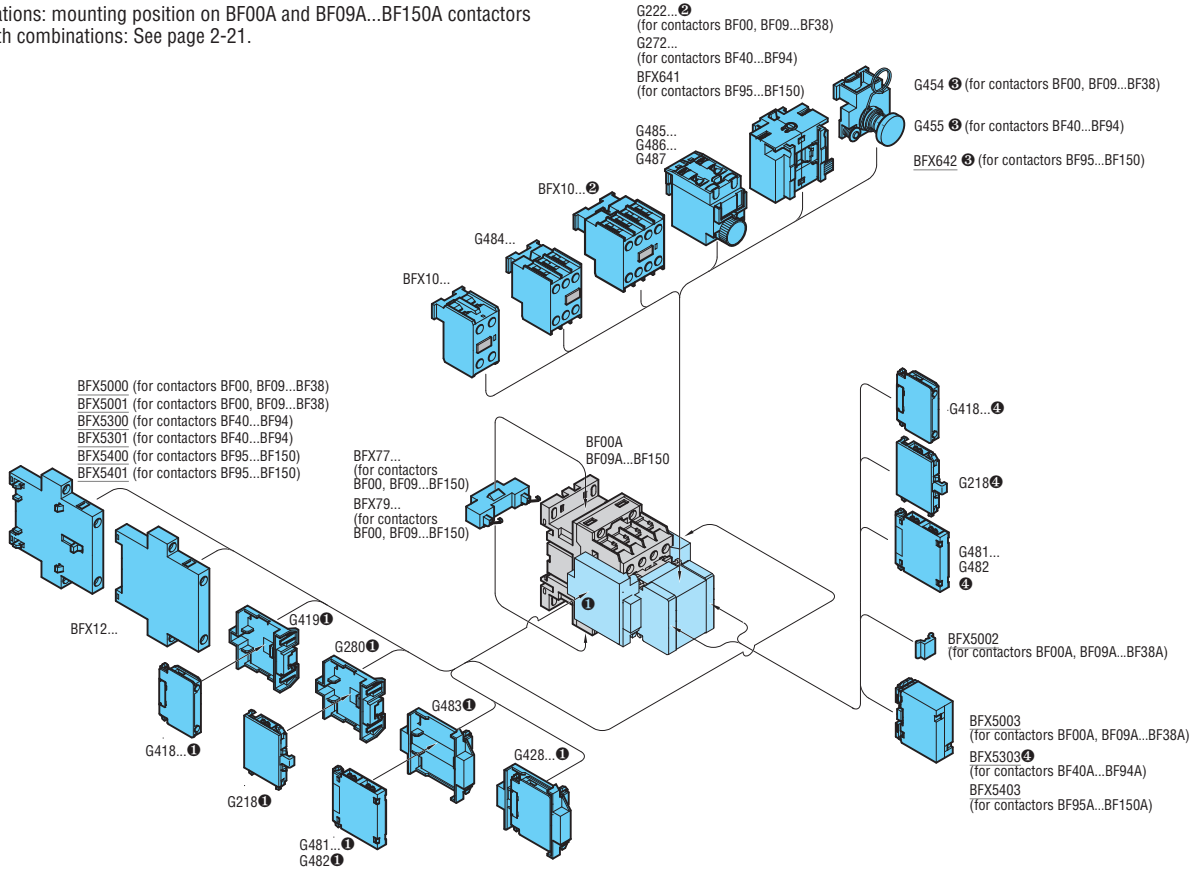

- ❶ Mounting is not possible if front lateral contacts or mechanical interlock BFX5000 or BFX5001 are mounted. BF00, BF09...38 cannot be fitted with BFX10 with 4 contacts or G222...
- ❷ Refer to the diagrams below for use of G222..., G272 and BFX641; see also the table of combinations on page 2-21.
- ❸ No add-on block can be mounted on front when the manual closing mechanism G454 or G455 is fitted.
- ❹ This accessory, for contactors BF09...BF94, cannot be mounted if a contact block BFX10... with 4 contacts (BFX1004, BFX1013, BFX1022, BFX1031, BFX1040) is installed.

Combinations: mounting position on BF00A and BF09A-BF38A contactors with mechanical latch G222 fitted.
Table with combinations: See page 2-21.

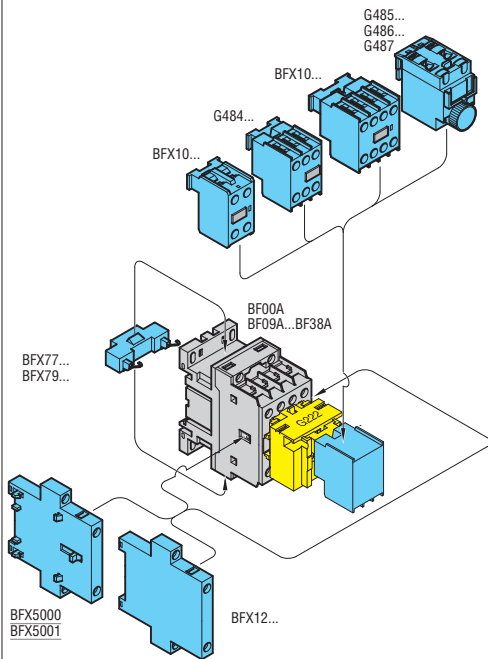

Combinations: mounting position on BF40A...150A, BF40E...BF150E, contactors with mechanical latch G272 fitted.
Table with combinations: See page 2-21.

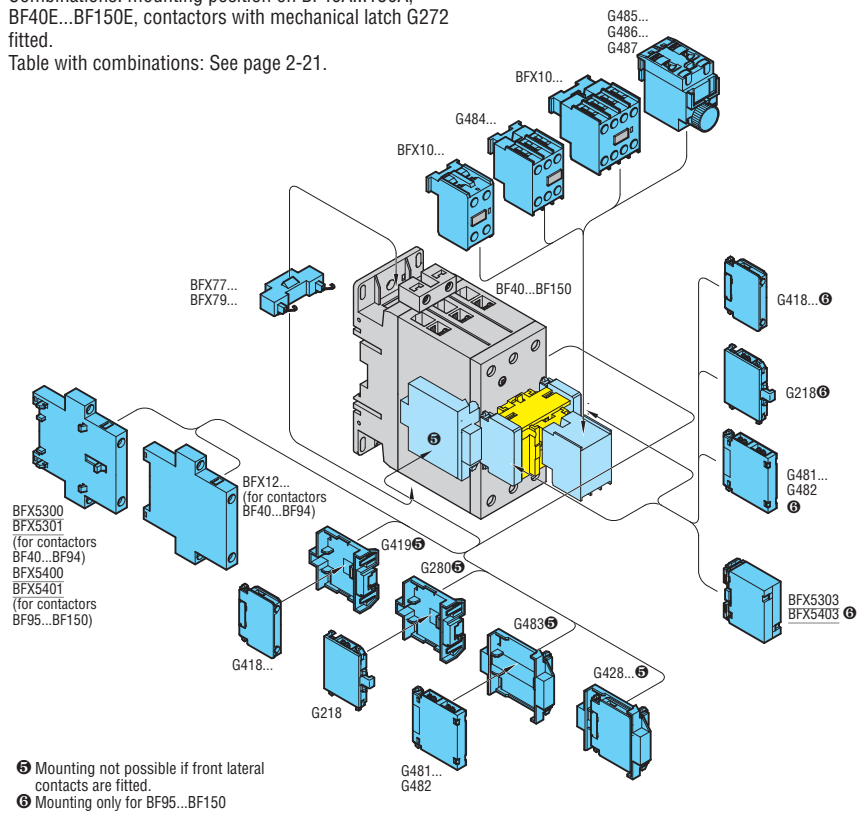

- ❺ Mounting not possible if front lateral contacts are fitted.
- ❻ Mounting only for BF95...BF150

Add-on blocks for DC and DC low consumption contactors

Combinations: mounting position on BF00 and BF09-BF38, D and L versions
 Table with combinations: See page 2-21.

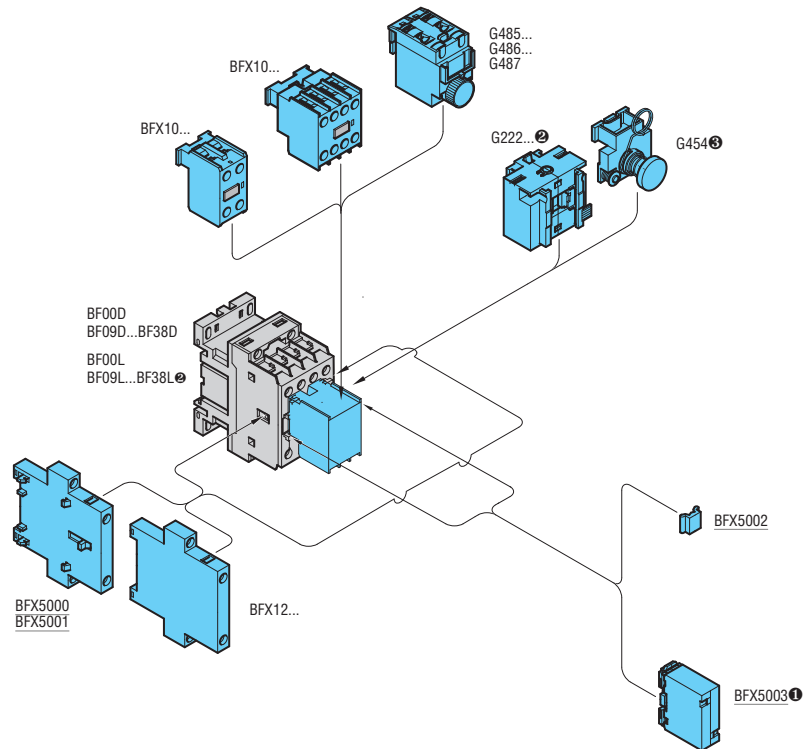

- ❶ Mounting not possible when the G222 mechanical latch is fitted.
- ❷ The G222 mechanical latch cannot be fitted on BF26L - BF38L four-pole types.
- ❸ No add-on block can be mounted on front when the G454 manual closing mechanism is fitted.

Accessories for AC, DC and DC low consumption contactors

Combinations

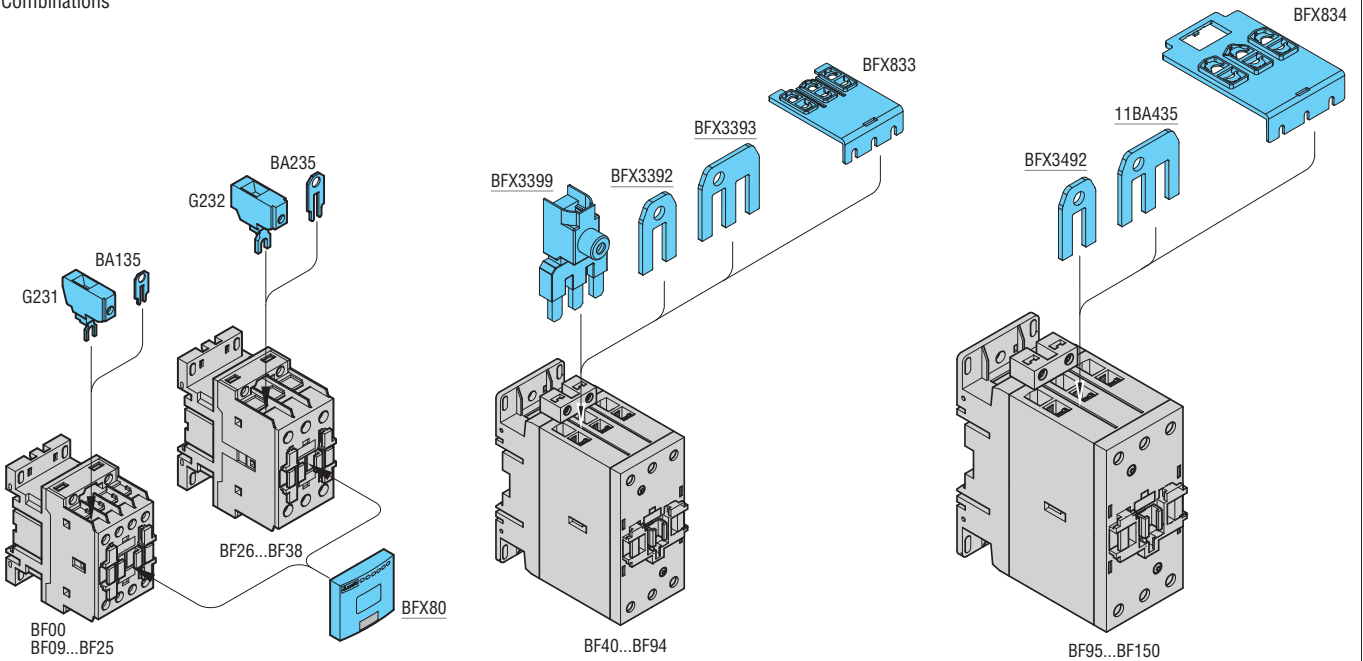

Accessories for AC, DC and DC low consumption contactors

Rigid connecting kits for three-pole reversing contactor assembly. For BF09...BF25

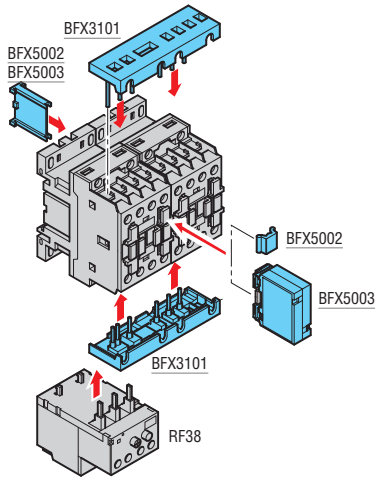

Rigid connecting kits for three-pole reversing contactor assembly. For BF09...BF25 and mechanical interlock BFX5000 or BFX5001

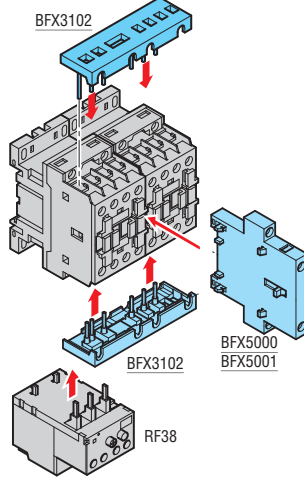

Rigid connecting kits for three-pole reversing contactor assembly. For BF26...BF38

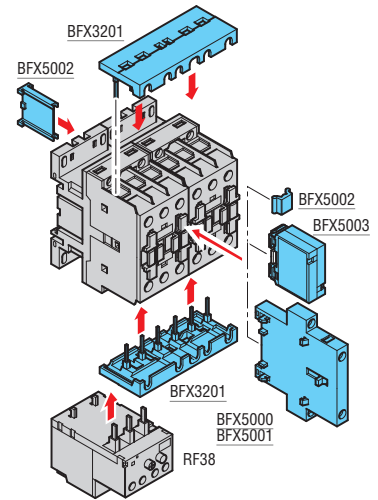

Rigid connecting kits for three-pole reversing contactor assembly. For BF40...BF94

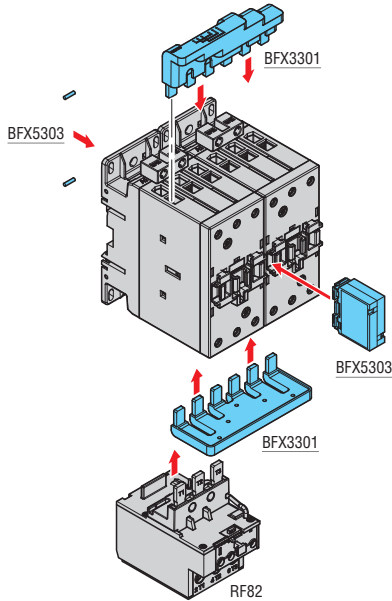

Rigid connecting kits for three-pole reversing contactor assembly. For BF95...BF150

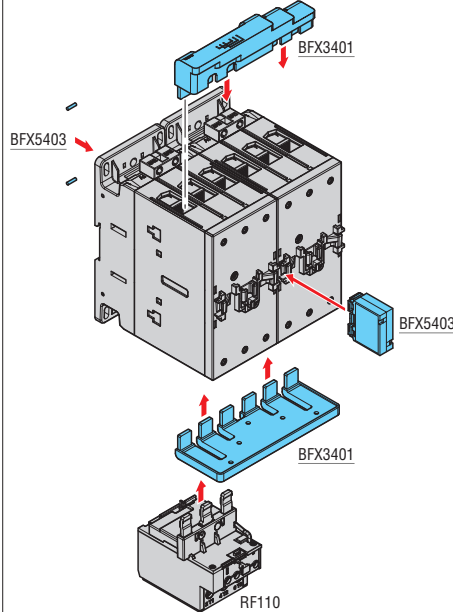

Rigid connecting kits for three-pole reversing contactor assembly. For BF09...BF25 contactors

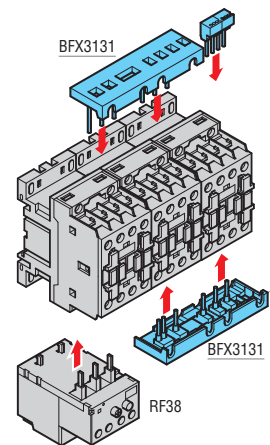

Rigid connecting kits for three-pole reversing contactor assembly. For BF26...BF38 (line-delta) and BF09...BF25 (star) contactors

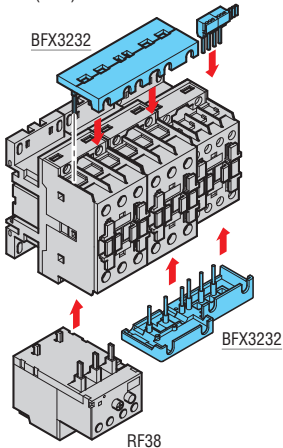

Rigid connecting kits for three-pole reversing contactor assembly. For BF26...BF38 contactors

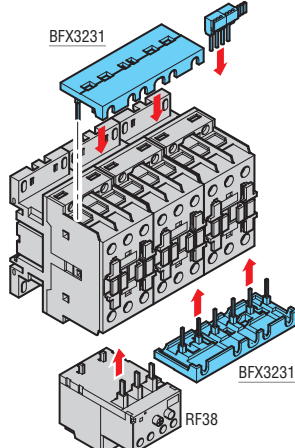

Rigid connecting kits for three-pole reversing contactor assembly. For BF40...BF94 (line-delta) and BF26...BF38 (star) contactors

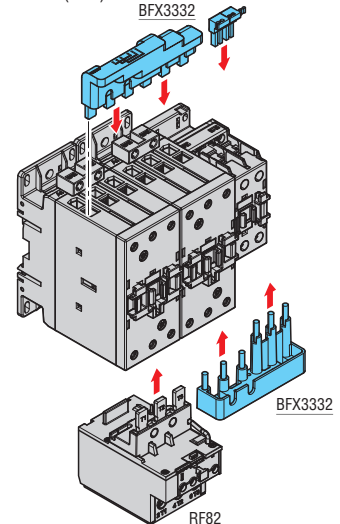

Rigid connecting kits for three-pole reversing contactor assembly. For BF40...BF94 contactors

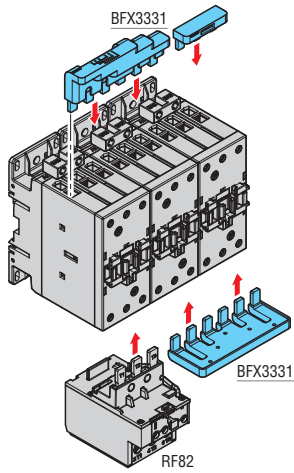

Rigid connecting kits for three-pole reversing contactor assembly. For BF95...BF150 (line-delta) and BF40...BF94 (star) contactors

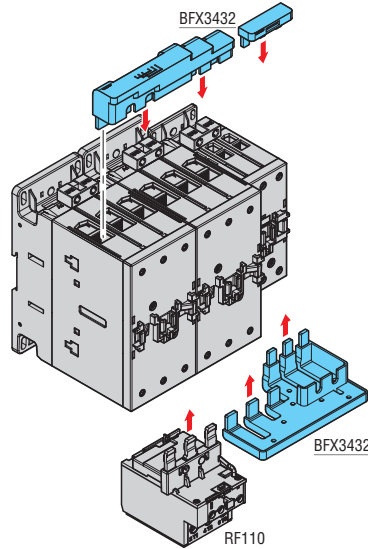

Rigid connecting kits for three-pole reversing contactor assembly. For BF95...BF150 contactors

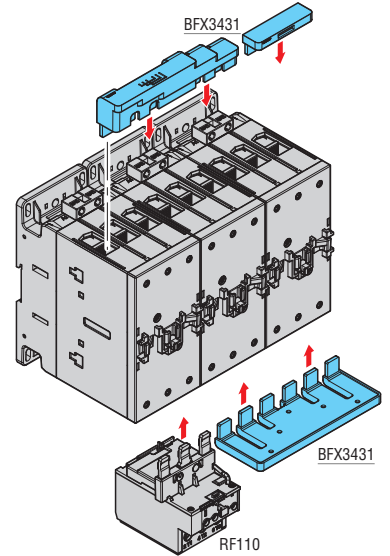

Rigid connecting kits for three-pole reversing contactor assembly. For BF40...BF94 contactors

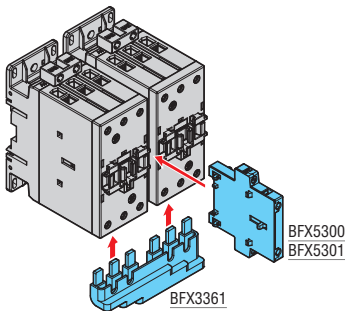

Rigid connecting kits for three-pole reversing contactor assembly. For BF95...BF150 contactors

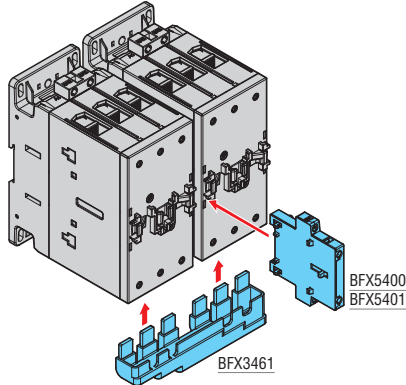

Rigid connecting kits for four-pole reversing contactor assembly. For BF40...BF94 contactors

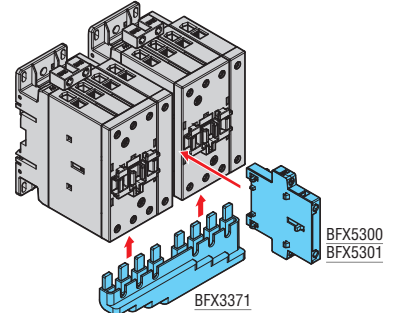

Rigid connecting kits for four-pole reversing contactor assembly. For BF95...BF150 contactors

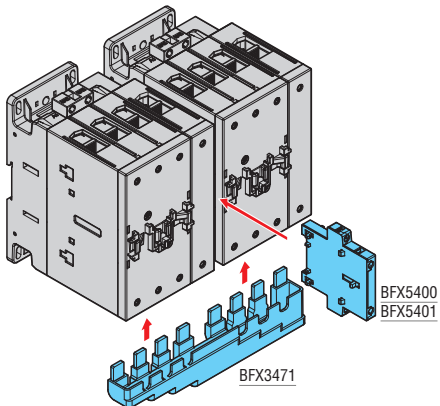

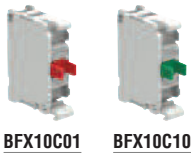

BFX10C01 **BFX10C10**

new



BFX12C...

new



BFX5500

new



BFX5503
BFX5504

new



BFX815

new



BFX835

BFX845

new



BFX805



GLX500
GLX501

GMX500

GMX501



BFX3583



BFX3584

Order code	Characteristics	Max qty per cont.	Qty per pkg.	Wt
		n°	n°	[kg]

Auxiliary contacts with front mounting
Screw terminals.

BFX10C10	1NO	6	10	0.048
BFX10C01	1NC	6	10	0.048

Auxiliary contacts with low side mounting.
Screw terminals.

BFX12C02	2NC	2	5	0.048
BFX12C11	1NO + 1NC	2	5	0.048
BFX12C20	2NO	2	5	0.048

Mechanical interlock.

BFX5500	For contactors BF160...BF230. Side by side mounting.	1	1	0.050
BFX5503	For contactors BF160...BF230. One on top of other mounting. Interaxis: 305...345mm	1	1	0.150
BFX5504	For contactors BF160...BF230. One on top of other mounting. Interaxis: 345...385mm	1	1	0.200

Order code	Characteristics	Qty per pkg.	Wt
		n°	[kg]

Power terminal protection.

BFX815 ①	One-pole terminal cover for BF160...BF230	6	0.026
BFX835	Three-pole terminal cover for BF16000...BF23000	1	0.050
BFX845	Four-pole terminal cover for BF160T4...BF230T4	1	0.070

Phase barrier.

BFX805	For BF160...BF230 order 4 pcs for three-pole contactors order 6 pcs for four-pole contactors	1	②	0.010
---------------	--	---	---	-------

Terminal clamp sets for rigid and flexible cables.

GLX500	1-piece set, each covers 1 pole. For AWG 6...kcmil 250 wires	1	0.011
GLX501	3-piece set, each covers 1 pole. For AWG 6...kcmil 250 wires	1	0.011
GMX500 ③	6-piece set, each covers 1 pole. For AWG 14...2/O wires	1	0.200
GMX501	6-piece set, each covers 1 pole. For AWG 4...kcmil 300 wires	1	0.200

Connecting kits

BFX3583	Terminal enlargement for three-pole contactors BF160...BF230	1	0.100
BFX3584	Terminal enlargement for four-pole contactors BF160...BF230	1	0.130
BFX3592	Two-pole non insulated paralleling link	1	0.050
BFX3593	Three-pole non insulated paralleling link	1	0.070
BFX3501	Connecting kit for reversing contactor assembly	1	1.000
BFX3531	Connecting kits for star-delta starter	1	1.100
BFX3561	Rigid connecting kit for three-pole changeover	1	0.900
BFX3571	Rigid connecting kit for four-pole changeover	1	1.200
BFX8508	Captive nut. 8-piece set	1	0.009

- ① It is supplied for one terminal only. Example: for three-pole contactor, order 3 pieces for the upper terminals or 6 pieces for all the upper and lower terminals.
- ② For currents higher than 175A, 2 pieces can be mounted for each contactor terminal.
- ③ Kit 4 pieces. For three-pole contactor order 1x BFX805; for four pole contactor order 2x BFX805.

Operational characteristics for add-on auxiliary contacts

Type		BFX10C10 BFX10C01	BFX12
IEC conventional free air thermal current Ith	A	10	10
IEC rated insulation voltage Ui	V	690	690
Terminals	Screw	M3.5	M3
	Width	mm	7
Tightening torque	Nm	0.8...1	0.8...1
	lb.in	7...9	7...9
Conductor section maximum with (1 or 2 cables)	flexible w/o lug	mm ²	2.5
	flexible c/w lug	mm ²	2.5
	AWG	n°	14
			14
Terminal protection per IEC/EN/BS 60529		IP20	IP20
UL/CSA and IEC/EN/BS 60947-5-1 designation	AC	A600	A600
	DC	Q600	Q600
Mechanical life (million)	cycles	10	10

Certifications and compliance

Certifications obtained:

Type	cULus	EAC	CCC
BFX10C...	●	①	①
BFX12C...	●	①	①

① Pending.

Add-on auxiliary contacts are compliant with the following standards: IEC/EN/BS 60947-1, IEC/EN/BS 60947-5-1, UL 60947-1, UL 60947-5-1, CSA C22.2 n° 60947-1, CSA C22.2 n° 60947-5-1.

The add-on auxiliary contact blocks BFX10C... and BFX12C... comply with annex F of the IEC/EN/BS 60947-4-1 standard "auxiliary contact linked with power contact" also known as mirror contact.

They also comply with Annex L of the IEC/EN/BS 60947-5-1 standard "mechanically linked contact elements".

Combinations: Mounting position on BF160...BF230 contactors

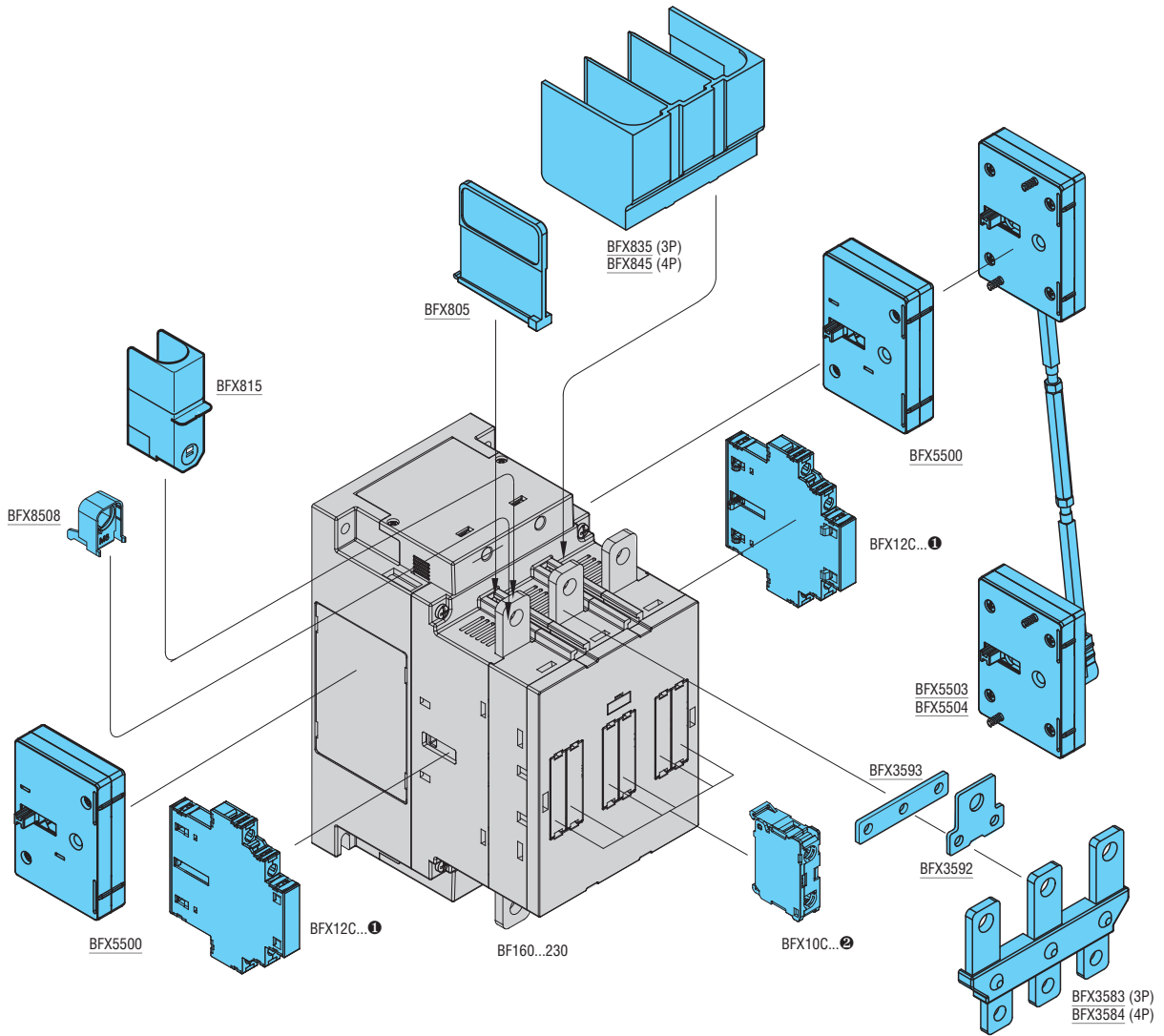

- ❶ Max 2 BFX12C... contact blocks per each contactor side.
- ❷ Max 6 BFX10C... contact blocks for three-pole contactors and 8 contact blocks for four-pole contactors.

Add-on blocks



11G350 - 11G354



11G358

Order code	Characteristics	Max qty per. contactor	Qty per pk	Wt sg
		n°	n°	[kg]
Auxiliary contacts. Faston terminals. Side mounting.				
11G350①	2NO+1NC or 1NO+2NC reversible	4	1	0.082
11G354①	1NO+1NC	4	1	0.078
Adapter.				
11G358②	For fitting auxiliary contacts BFX10..., with 2 contacts, G484..., G485..., G486... and G487 on contactors B250...B6301000	4	5	0.050
Mechanical interlock.				
11G355②③	Side by side	1	1	0.026
11G356 1②④	One on top of other	1	1	0.120
11G356 2②④	One on top of other	1	1	0.126
11G356 3②④	One on top of other	1	1	0.132
11G356 4②④	One on top of other	1	1	0.140
11G356 5②④	One on top of other	1	1	0.146
11G356 6②⑤	One on top of other	1	1	0.150
Mechanical latch.				
11G495⑥⑦⑧	For B250...B630③	1	1	0.795

⑥ For use with mechanical interlock see page 2-77.

Accessories



11G363



11G527 - 11G528 - 11G529 - 11G530



11G370



11G371

Order code	Characteristics	Qty per pkg	Wt
		n°	[kg]
Power terminal protection.			
11G363⑨	For contactors B250-B310-B400	6	0.046
11G527	For contactor B500	1	0.238
11G528	For contactor B5004	1	0.265
11G529	For contactor B630	1	0.238
11G530	For contactor B6304	1	0.266
3 pole star connecting bars.			
11BA1721	For contactors B250-B310-B400	1	0.140
11BA1846	For contactors B500-B630	1	0.341
2 pole bars for parallel arrangement.			
11BA1720	For contactors B250-B310-B400	1	0.149
11BA1845	For contactors B500-B630	1	0.322
Terminal adapter.			
11G370	To transform Faston terminals of auxiliary contacts and coils into screw terminals	10	0.003
11G371	To transform both coil Faston terminals into screw terminals	5	0.022

- ① Only for B250-B310-B400-B500-B630-B6301000.
- ② Not suitable for B6301000-B1250-B1600 ⑤.
- ③ For use with three-pole B6301000, consult Technical support for information; see contact details on inside front cover.
- ④ Allowed distances see page 2-76.
- ⑤ For contactors B1250 and B1600, two G3566 mechanical interlocks are required.
- ⑥ Replace with the digit of the voltages if 50 or 60 Hz or with the letter C followed by voltage if DC. The standard voltages are:
 - AC 50/60Hz 48 - 110...125 (indicate 110) - 220...240 (indicate 220) - 380...415 (indicate 380)
 - DC 48 - 110...125 (indicate 110) - 220...240 (indicate 220).
- ⑦ It can be mounted only in contactors if predisposed for it. Technical support for information; see contact details on inside front cover.
- ⑧ Not suitable for B310 and B310 4.
- ⑨ Provided for one pole terminal only. Example: For three-pole contactors, purchase 3 pieces for the upper terminals only or 6 pieces for all upper and lower terminals.

Operational characteristics of auxiliary contacts

Type	G350-G354	
IEC conventional free-air thermal current Ith	A	16
IEC rated insulation voltage Ui	V	690
Terminals Faston		1-6.35x0.8 2-2.8x0.8
Conductor section maximum (with 1 or 2 cables)		
flexible c/w lug	mm²	2.5
AWG	n°	14
UL/CSA and IEC/EN/BS 60947-5-1 designation	AC	A600
	DC	P600
Mechanical life (million)	cycles	5

Type	G495⑩	
Rated AC control circuit voltage	V	48...480
AC (50/60Hz)	V	48...480
DC	V	48...480
Power consumption with control in:		
AC	VA	1500
DC	W	1100
Minimum energising:		
drop-out	ms	40
pick-up	ms	300
Terminals Faston		1-6.3x0.8

Type	G370-G371	
Tightening torque	Nm	1
	lb.in	8.9
Tool	Type	PH2
Conductor section (with 1 or 2 cables)	mm²	4
	AWG	10

Certifications and compliance

Certifications obtained:

Type	UL	CSA	EAC	CCC
G350	UL	●	●	●
G354	UL	●	●	—
G355	—	●	●	—
G356 ...	—	●	●	—
G361	—	●	●	—
G362	—	●	●	—
G363	—	●	●	—
G370	—	●	●	—

● Certified products.

UL - UL Recognized for USA only (File E93601) as Auxiliary Devices - Component.

Products having this type of marking are intended for use as components of complete workshop-assembled equipment.

CSA - CSA Recognized for Canada only (File 54332) as Auxiliary Devices for motor controllers.

Compliant with standards: IEC/EN/BS 60947-1, IEC/EN/BS 60947-4-1, UL 60947-1, UL 60947-4-1, IEC/EN/BS 60947-4-1, UL508, CSA C22.2 n° 14; add-on auxiliary contacts also comply with: IEC/EN/BS 60947-5-1, UL 60947-5-1, CSA C22.2 n° 60947-5-1.

The add-on auxiliary contact blocks 11G350 and 11G354 comply with annex F of the IEC/EN/BS 60947-4-1 standard "auxiliary contact linked with power contact" also known as mirror contact.

Combinations: Mounting position on B250...B630 contactors

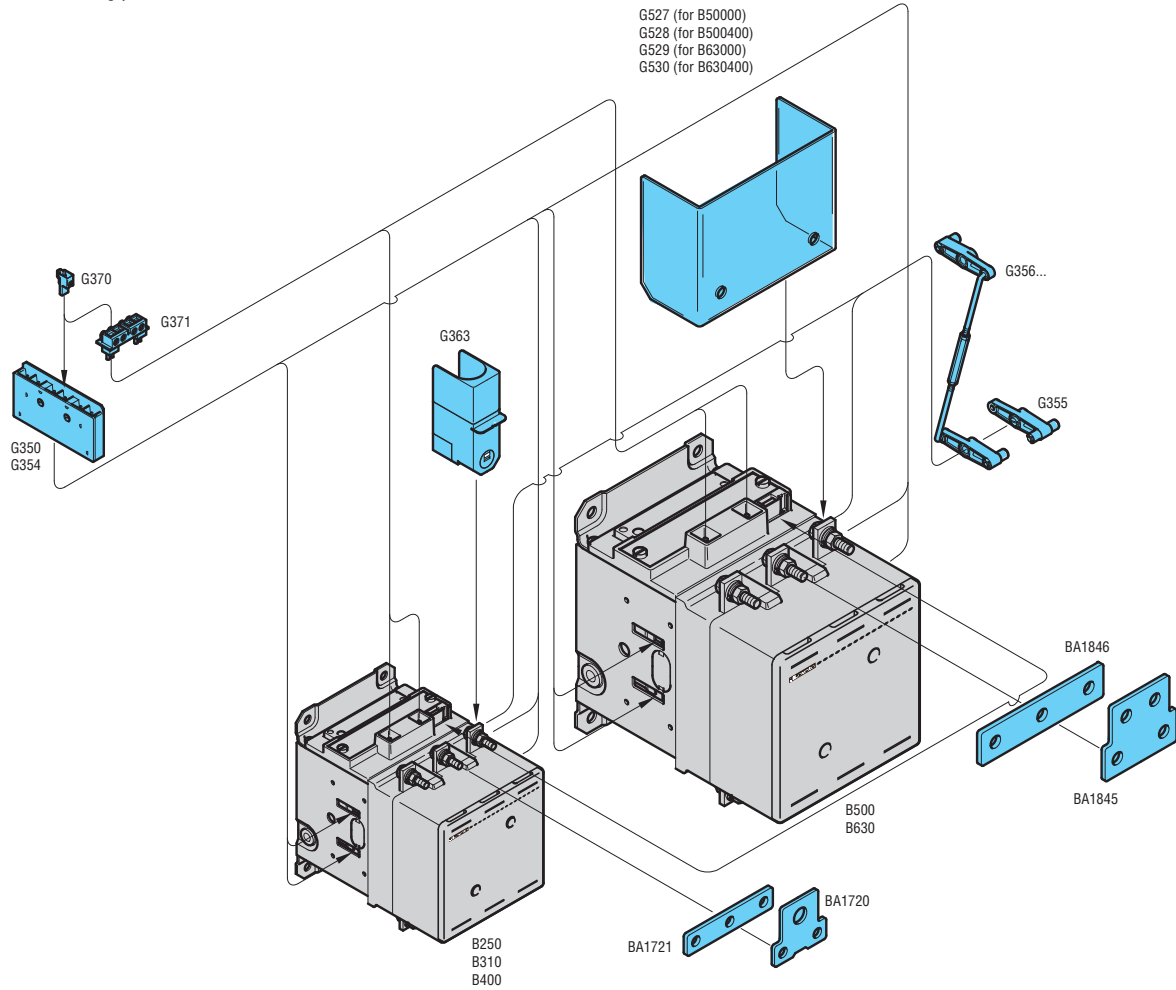

The add-on auxiliary contact blocks G350 and G354 can be applied to contactors B250-B6301000 only up to a maximum of four pieces for each contactor, for a total of 12 contacts.
The contact block G350 provides a 2NO+1NC or 1NO+2NC combination depending on its mounting position; see the drawing below. The G354 block consists of 1NO+1NC.

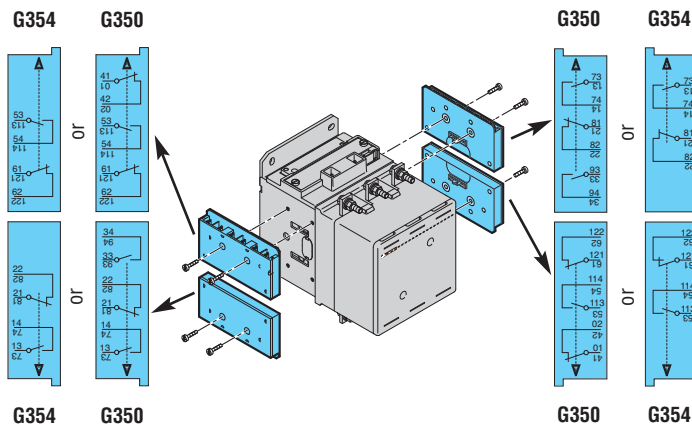

Contact blocks, BFX10 with 2 contacts, G484, G485, G486 and G487 types, can be mounted using the G358 adapter, refer to page 2-20 for exact types and order codes of the blocks.
A maximum of four adapters can be possibly used per contactor and each adapter can hold one BFX10, G484, G485, G486 and G487.

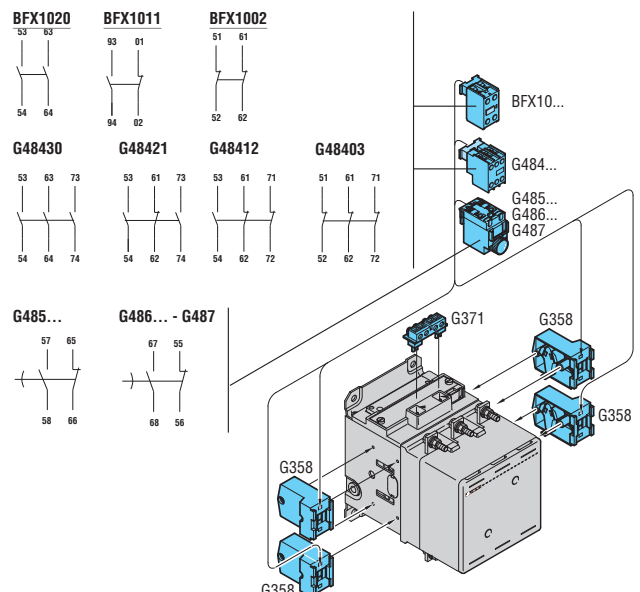

2 Contactors

Spare parts for BF series contactors

AC coils

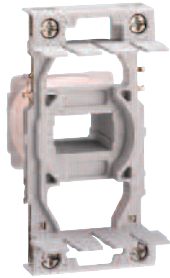

BF91A...

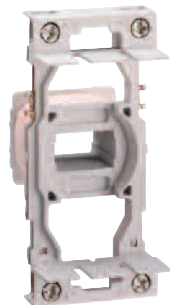

BF92A...

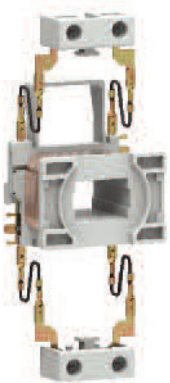

BF93A...

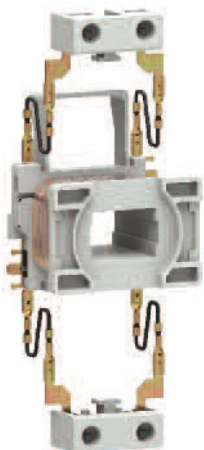

BF94A...

Order code	Rated frequency and voltage		Qty per pkg n°	Wt [kg]
	[Hz]	[V]		

For contactors BF00A-BF09A-BF12A-BF18A-BF25A.

BFX91A024 ①	50/60	24VAC	1	0.085
BFX91A048 ①		48VAC	1	0.085
BFX91A110 ①		110VAC	1	0.085
BFX91A230 ①		230VAC	1	0.085
BFX91A400 ①		400VAC	1	0.085
BFX91A024 60 ①	60	24VAC	1	0.085
BFX91A048 60 ①		48VAC	1	0.085
BFX91A120 60 ①		120VAC	1	0.085
BFX91A220 60 ①		220VAC	1	0.085
BFX91A230 60 ①		230VAC	1	0.085
BFX91A460 60 ①		460VAC	1	0.085
BFX91A575 60 ①		575VAC	1	0.085

For contactors BF26A-BF32A-BF38A.

BFX92A024 ①	50/60	24VAC	1	0.088
BFX92A048 ①		48VAC	1	0.088
BFX92A110 ①		110VAC	1	0.088
BFX92A230 ①		230VAC	1	0.088
BFX92A400 ①		400VAC	1	0.088
BFX92A02460 ①	60	24VAC	1	0.088
BFX92A04860 ①		48VAC	1	0.088
BFX92A12060 ①		120VAC	1	0.088
BFX92A22060 ①		220VAC	1	0.088
BFX92A23060 ①		230VAC	1	0.088
BFX92A46060 ①		460VAC	1	0.088
BFX92A57560 ①		575VAC	1	0.088

For contactors BF40A-BF50A-BF65A-BF80A-BF94A-BFD65A-BFD80A.

BFX93A024 ①	50/60	24VAC	1	0.150
BFX93A048 ①		48VAC	1	0.150
BFX93A110 ①		110VAC	1	0.150
BFX93A230 ①		230VAC	1	0.150
BFX93A400 ①		400VAC	1	0.150
BFX93A02460 ①	60	24VAC	1	0.150
BFX93A04860 ①		48VAC	1	0.150
BFX93A12060 ①		120VAC	1	0.150
BFX93A22060 ①		220VAC	1	0.150
BFX93A23060 ①		230VAC	1	0.150
BFX93A46060 ①		460VAC	1	0.150
BFX93A57560 ①		575VAC	1	0.150

For contactors BF95A-BF115A-BF150A.

BFX94A024 ①	50/60	24VAC	1	0.185
BFX94A048 ①		48VAC	1	0.185
BFX94A110 ①		110VAC	1	0.185
BFX94A230 ①		230VAC	1	0.185
BFX94A400 ①		400VAC	1	0.185
BFX94A02460 ①	60	24VAC	1	0.185
BFX94A04860 ①		48VAC	1	0.185
BFX94A12060 ①		120VAC	1	0.185
BFX94A22060 ①		220VAC	1	0.185
BFX94A23060 ①		230VAC	1	0.185
BFX94A46060 ①		460VAC	1	0.185
BFX94A57560 ①		575VAC	1	0.185

① Four-terminal coil.

Operational characteristics for BFX91A, BFX92A, BFX93A and BFX94A coils

AC control

Rated voltage at 50/60, 60Hz	V	12...600				
Operating voltage limits						
50/60Hz coil 50Hz powered at	pick-up	% Us 80...110				
	drop-out	% Us 20...55				
	60Hz	pick-up	% Us 85...110			
		drop-out	% Us 20...55			
60Hz coil powered at 60Hz	pick-up	% Us 80...110				
	drop-out	% Us 20...55				
Average coil consumption at ≤20°C						
50/60Hz coil 50Hz powered at	in-rush	VA	BFX91 75	BFX93 210	BFX94 300	
		holding	VA	9	15	20
	60Hz	in-rush	VA	70	195	275
		holding	VA	6.5	13	17
	60Hz coil powered at 60Hz	in-rush	VA	75	210	300
		holding	VA	9	15	20
Dissipation at 50Hz	W	2.5	5	6.5		

Materials

Class F enamelled copper wire.

Special versions

For coils with non standard voltages, consult Technical support for information; see contact details on inside front cover.

new

AC/DC and DC coils

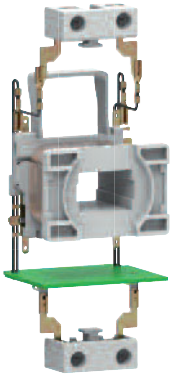

BFX93E...

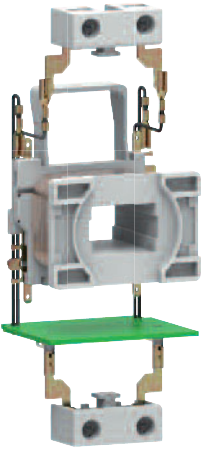

BFX94E...

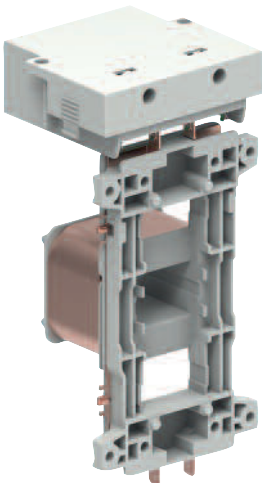

BFX95E...

new

Order code	Rated voltage	Qty per pkg	Wt
	[V]	n°	[kg]
For contactors BF40E-BF50E-BF65E-BF80E-BF94E-BFD80E.			
BFX93E024	20...48V AC/DC	1	0.190
BFX93E110	60...110V AC/DC	1	0.190
BFX93E230	100...250V AC/DC	1	0.190
For contactors BF95E-BF115E-BF150E-BFD150E.			
BFX94E024	20...48V AC/DC	1	0.225
BFX94E110	60...110V AC/DC	1	0.225
BFX94E230	100...250V AC/DC	1	0.225
For contactors BF160E-BF195E-BF230E-BFD230E.			
BFX95E024	24...60VAC / 20...60VDC	1	0,400
BFX95E110	60...130VAC/DC	1	0,400
BFX95E230	100...250VAC/DC	1	0,400
BFX95E400	250...500VAC/DC	1	0,400

NOTE: no coil replacement for contactors BF00 D, BF09D-BF38D, BF00L, BF09L-BF38L is possible.

- ① For BF80T2E... contactors the coil supply voltage must be AC or smoothed DC. For pulsating DC please consult our Technical support.
- ② Four-terminal coil.

Operational characteristics for BFX93E coil

AC/DC control			
Rated voltage		V	20...250
Operating voltage limits: 50/60 Hz coil powered at or in DC	pick-up	% Us	80...110①
	drop-out	% Us	≤70% Us min
Average coil cons. at ≤20°C	in-rush	W	45...75
	holding	W	1.2...2.1

Operational characteristics for BFX94E...

AC/DC control			
Rated voltage		V	20...250
Operating voltage limits: 50/60 Hz coil powered at or in DC	pick-up	% Us	80...110①
	drop-out	% Us	≤70% Us min
Average coil cons. at ≤20°C	in-rush	W	65...110
	holding	W	1.8...3

Operational characteristics for BFX95E...

AC/DC control			
Rated voltage		V	20...250
Operating voltage limits: 50/60 Hz coil powered at or in DC	pick-up	% Us	80...110①
	drop-out	% Us	≤70% Us min
Average coil cons. at ≤20°C	in-rush	W	160...230
	holding	W	1.5...3

① 80% of Us min. and 110% of Us max.

Materials

Class F enamelled copper wire.

Special versions

For coils with non standard voltages, consult Technical support for information; see contact details on inside front cover.

AC/DC coils



Coil



Bridge rectifier



Coil protection



Coil assembly

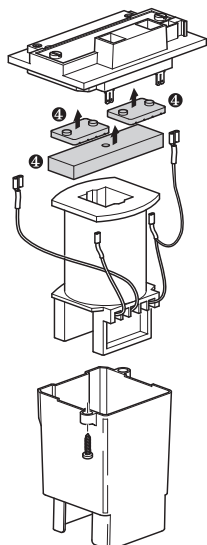

Order code	Rated voltage AC 50/60Hz and DC	Qty per pkg	Wt
	[V]	n°	[kg]

Coil for B250-B310-B400 contactors.			
11BA169924	24VAC/DC	1	1.800
11BA169948	48VAC/DC	1	1.800
11BA169960	60VAC/DC	1	1.800
11BA1699110	110...125VAC/DC	1	1.800
11BA1699220	220...240VAC/DC	1	1.800
11BA1699380	380...415VAC/DC	1	1.800
11BA1699440	440...480VAC/DC	1	1.800

Coil for B500-B630-B630 1000 contactors.			
11BA180048	48VAC/DC	1	3.400
11BA180060	60VAC/DC	1	3.400
11BA1800110	110...125VAC/DC	1	3.400
11BA1800220	220...240VAC/DC	1	3.400
11BA1800380	380...415VAC/DC	1	3.400
11BA1800440	440...480VAC/DC	1	3.400

Coil for B1250-B1600 contactors.			
11BA1800110ⓐ	110...125VACⓐ	1	3.400
11BA1800220ⓐ	220...240VACⓐ	1	3.400

Order code	For contactor	Qty per pkg	Wt
		n°	[kg]

Bridge rectifier (Faston terminals).			
11BA17001ⓐ	B250-B310-B400	1	0.230
11BA1799ⓐ	B500-B630-B6301000 B1250-B1600	1	0.520

Coil protection.			
11BA1678	B250-B310-B400	1	0.079
11BA1803	B500-B630-B6301000 B1250-B1600	1	0.164

Coil assembly (Coil, rectifier and coil protection).			
11BA1671ⓐ	B250-B310-B400	1	2.290
11BA1796ⓐ	B500-B630-B630 1000 B1250-B1600	1	4.650

- ⓐ Available for AC supply only.
- ⓑ Add the coil voltage digit. Standard voltages are:
- AC/DC 24 - 48 - 60 - 110...125 (indicate 110) - 220...240 (indicate 220) - 380...415 (indicate 380) - 440...480V (indicate 440).
Example: 11BA1671110 for B250...B400 contactor coil assembly suitable for 110-125VAC/DC supply.
- ⓒ Add the coil voltage digit. Standard voltages are:
- AC/DC 48 - 60 - 110...125 - 220...240 - 380...415 - 440...480V.
Example: 11 BA1796 110 for B500-B1600 contactor coil assembly suitable for 110-125VAC/DC supply.
- For B1250 and B1600 only 110...125 and 220...240VAC voltages are available.
- ⓓ When replacing the coil, retrieve the dampers (1 pair for B250...B400 and 2 pairs for B500...B1600) and the fixed core and refit them with the new coil.
- ⓔ For contactors with coil voltage up to 415V. For higher voltages add suffix 440 to the code. E.G.: 11BA17001440.

Operational characteristics

AC and DC control			
For contactor type		B250 - B310 - B400	
Supply voltage		AC and DC	
Rated control voltage		V	24...480
Operating limits	pick-up	% Us	80...110
	drop-out	% Us	20...60
Consumption	in-rush	VA/W	300
	holding	VA/W	10
Dissipation		W	10

For contactor type		B500 - B630 - B630 1000	
Supply voltage		AC and DC	
Rated control voltage		V	48...480
Operating limits	pick-up	% Us	80...110
	drop-out	% Us	20...60
Consumption	in-rush	VA/W	400
	holding	VA/W	18
Dissipation		W	18

For contactor type		B1250 - B1600	
Supply voltage		AC	
Rated control voltage		V	110/240
Operating limits	pick-up	% Us	80...110
	drop-out	% Us	20...60
Consumption	in-rush	VA/W	800
	holding	VA/W	45
Dissipation		W	40

Materials

Class F enamelled copper wire.

Coil assembly

Comprises the coil, bridge rectifier, fixed core, coil protection, cross piece and fixing screws.

Special versions

For coils with non standard voltages, consult Technical support for information; see contact details on inside front cover.

Main contacts for BF contactors



BFX99...

new

Order code	For contactor	Qty per pkg	Wt
		n°	[kg]

Main contacts.
3 or 4 pole set complete with screws.

BFX99026T	BF2600	1	0.038
BFX99026F	BF26T4	1	0.051
BFX99032T	BF3200	1	0.070
BFX99038T	BF3800	1	0.070
BFX99038F	BF38T4	1	0.093
BFX99040T	BF4000	1	0.095
BFX99040F	BF40T4	1	0.127
BFX99050T	BF5000	1	0.095
BFX99050F	BF50T4	1	0.127
BFX99065T	BF6500	1	0.095
BFX99065F	BF65T4	1	0.127
BFX99080T	BF8000	1	0.100
BFX99080F	BF80T4	1	0.130
BFX99094T	BF9400	1	0.100
BFX99095T	BF9500	1	0.210
BFX99095F	BF95T4	1	0.280
BFX99115T	BF11500	1	0.225
BFX99115F	BF115T4	1	0.300
BFX99150T	BF15000	1	0.225
BFX99150F	BF150T4	1	0.300
BFX99160T	BF160	1	0.350
BFX99160F	BF160T4	1	0.450
BFX99195T	BF195	1	0.350
BFX99195F	BF195T4	1	0.450
BFX99230T	BF230	1	0.350
BFX99230F	BF230T4	1	0.450

Special versions

For non standard spare contact configurations, contact Technical support; see contact details on inside front cover.

NOTE: For B1250 and B1600 contactor spares, consult Technical support for information; see contact details on inside front cover.

Main contacts and arc chutes for B contactors



11G383... - 11G384... - 11G385...
11G525... - 11G526... - 11G537...

new

Order code	For contactor	Qty per pkg	Wt
		n°	[kg]

Main contacts.
3 or 4 pole set complete with Allen screws and key for contact replacement.

11G383	B250	1	0.770
11G3834	B2504	1	1.030
11G385	B310	1	0.770
11G3854	B3104	1	1.030
11G384	B400	1	0.770
11G3844	B4004	1	1.030
11G525	B500	1	2.520
11G5254	B5004	1	3.360
11G526	B630	1	2.660
11G5264	B6304	1	3.550
11G537	B6301000	1	2.660
11G5374	B63010004	1	3.550
11G538	B125024	1	5.040
11G5384	B1250424	1	6.720
11G539	B160024	1	5.320
11G5394	B1600424	1	7.100

Arc chutes.

BFX9805T	BF16000-BF19500-BF23000	1	1.000
BFX9805F	BF160T4-BF195T4-BF230T4	1	1.200
11BA1713	B250-B310-B400	1	1.210
11BA1714	B2504-B3104-B4004	1	1.600
11BA1838	B500-B630-B6301000	1	1.910
11BA1839	B5004-B6304-B63010004	1	2.490



Arc chute 11BA...

2 Contactors

Dimensions [mm (in)]

INDEX

BG... MINI-CONTACTORS WITH AC OR DC SUPPLY VOLTAGE

BG... three poles with screw terminals and **RF...9** thermal overload relay

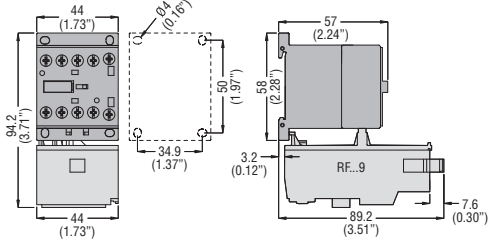

BG...T... four poles, with screw terminals

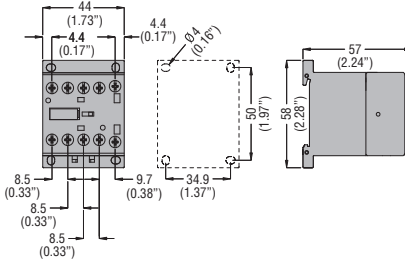

BGP... with rear PCB solder pins

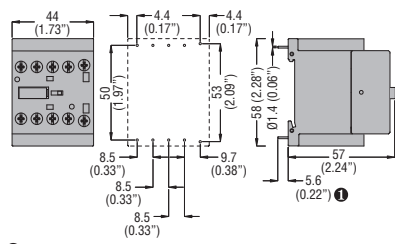

BGF... with Faston terminals

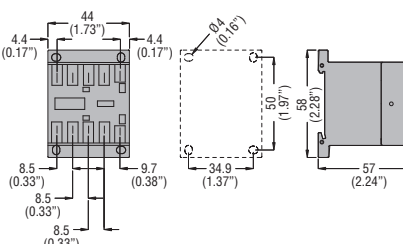

① Recommended PCB drillings 1.7-2mm.

BF... CONTACTORS WITH AC SUPPLY VOLTAGE

BF00A... BF09 A... - BF12A... - BF18A... - BF25A... three poles with **RF...38** thermal overload relay

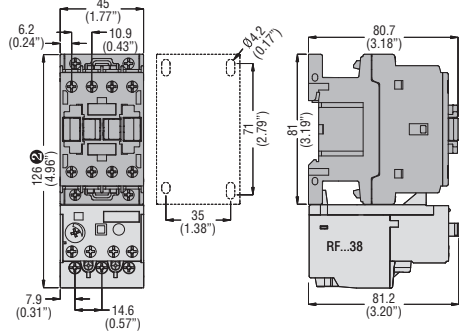

② 135mm/5.31" for RFE45

BF09T...A... - BF12T...A... - BF18T...A... four poles

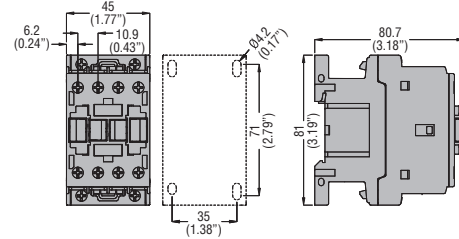

BF2600A... - BF3200A... - BF3800A... three poles with **RF...38** thermal overload relay

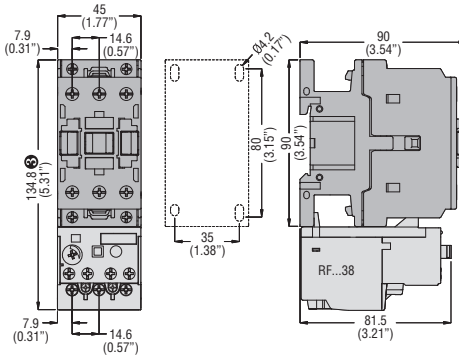

③ 144mm/5.67" for RFE45

BF26T...A... - BF38T...A... four poles

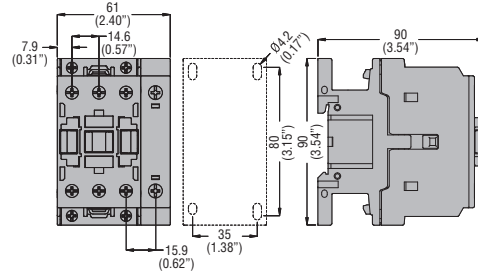

BF4000A... - BF5000A... - BF6500A... - BF8000A... - BF9400A... three poles with **RF82** thermal overload relay

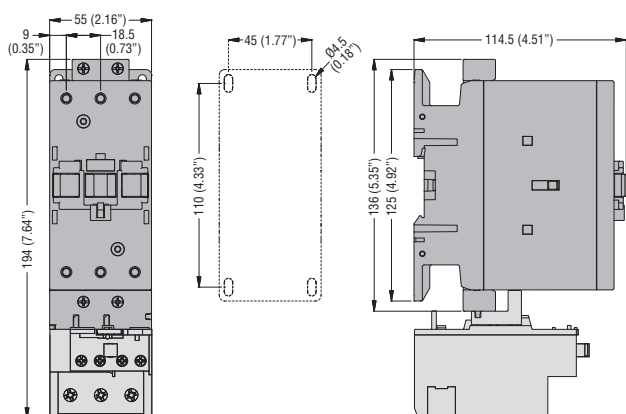

BF40T4...A... - BF50T4...A... - BF65T4...A... - BF80T4...A... - BFD80T4... - BF80T2A... four poles

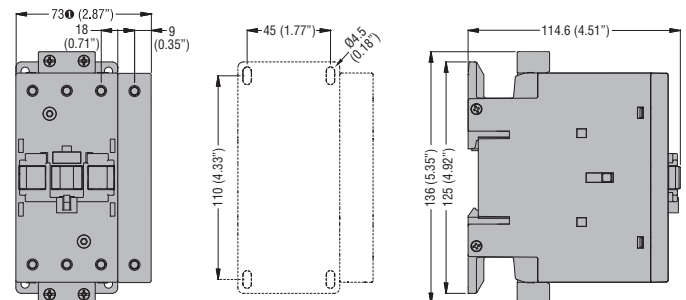

④ BF80T2 91mm/3.58", BFD6500... 55mm/2.16"

2 Contactors

Dimensions [mm (in)]

BF9500A... - BF11500A... - BF15000A... three poles with **RF110** thermal relay

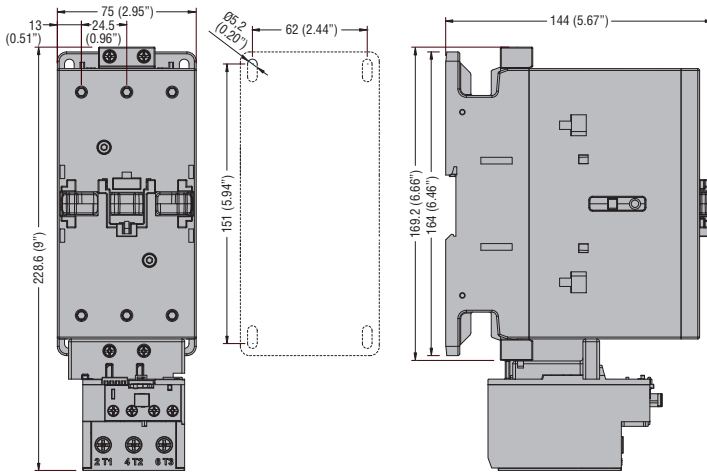

BF95T4A... - BF115T4A... - BF150T4A... four poles

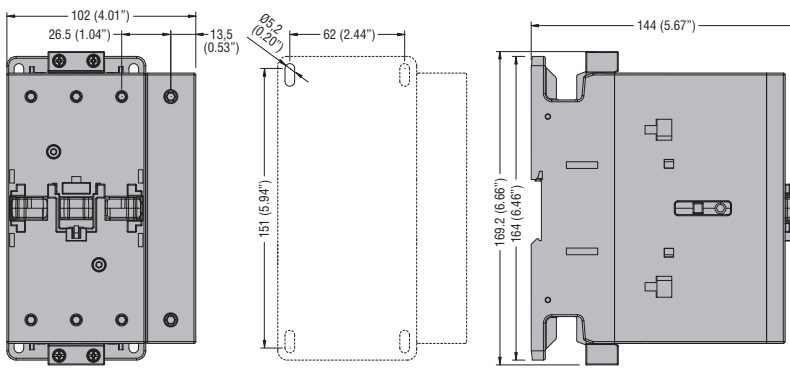

BF...CONTACTORS WITH DC SUPPLY VOLTAGE

BF00...D and BF00...L - BF09... - BF12... - BF18... - BF25...D and L three poles with **RF...38** thermal overload relay

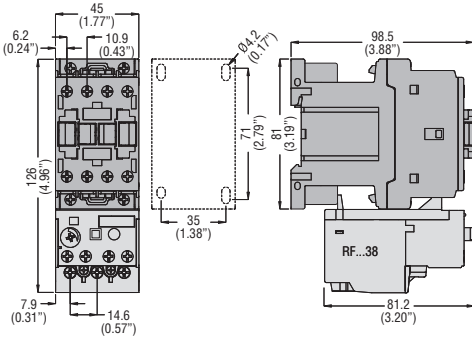

Control relays

BF00...D and BF00...L
BF09T... - BF18T... D and L four poles

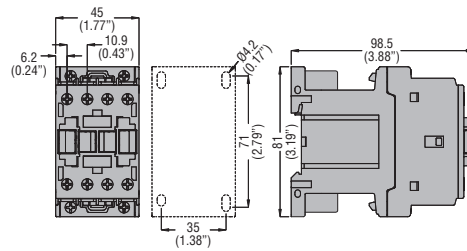

BF26... - BF32... - BF38...D and L three poles with **RF...38** thermal overload relay

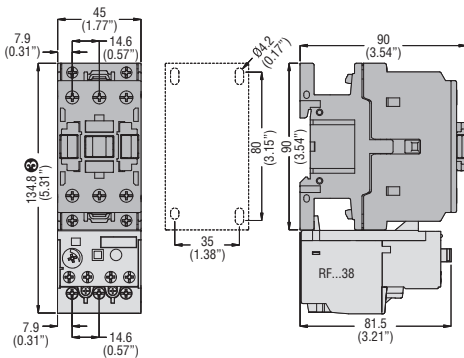

BF26T... - BF38 T...D and L four poles

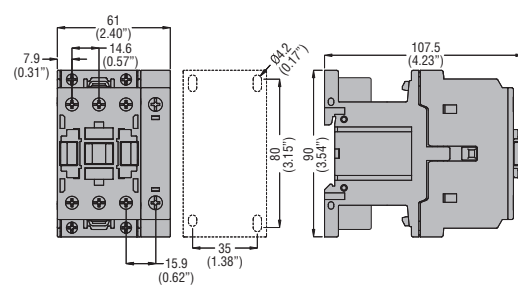

2 Contactors

Dimensions [mm (in)]

BF4000E... - BF5000E... - BF6500E... - BF8000E... - BF9400E...
three poles with **RF82** thermal overload relay

BF65T4E... - BF80T4E... - BF80T2E... four poles

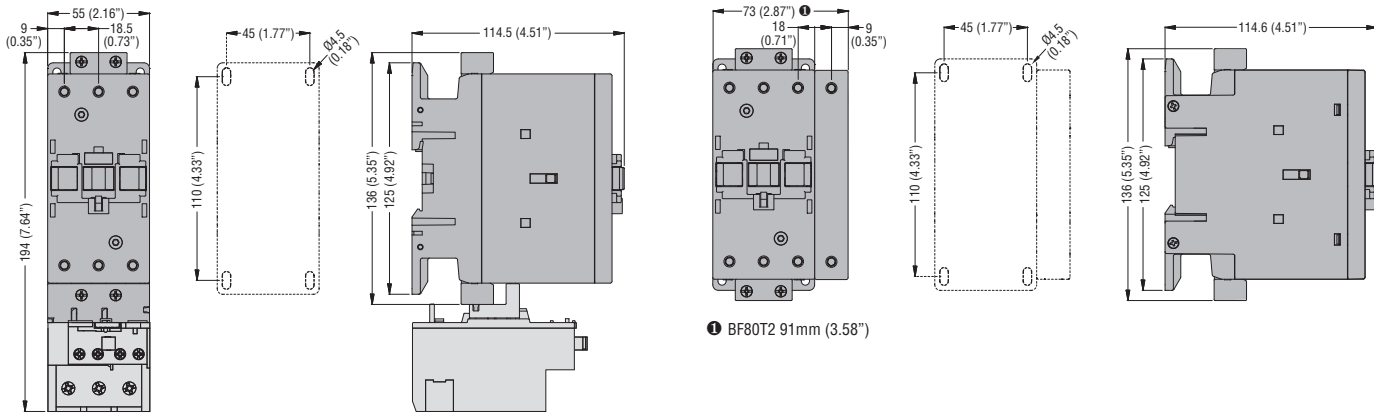

BF9500E... - BF11500E... - BF15000E... three poles with **RF110** thermal relay

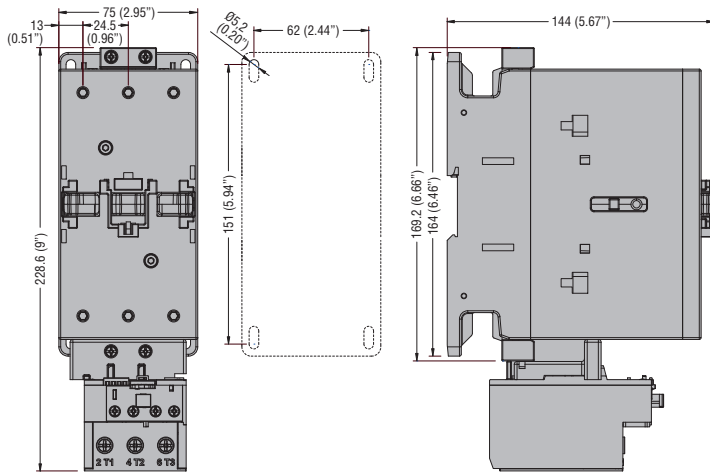

BF95T4E... - BF115T4E... - BF150T4E... - BFD150T4E... four poles

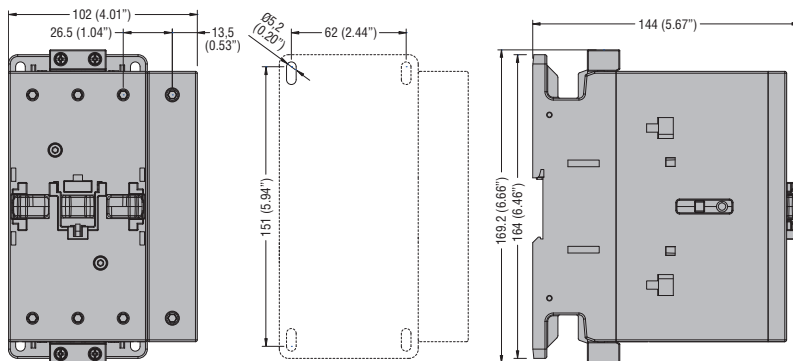

2 Contactors

Dimensions [mm (in)]

BF...CONTACTORS WITH AC/DC SUPPLY VOLTAGE

BF16000E... - BF19500E... - BF23000E... three poles

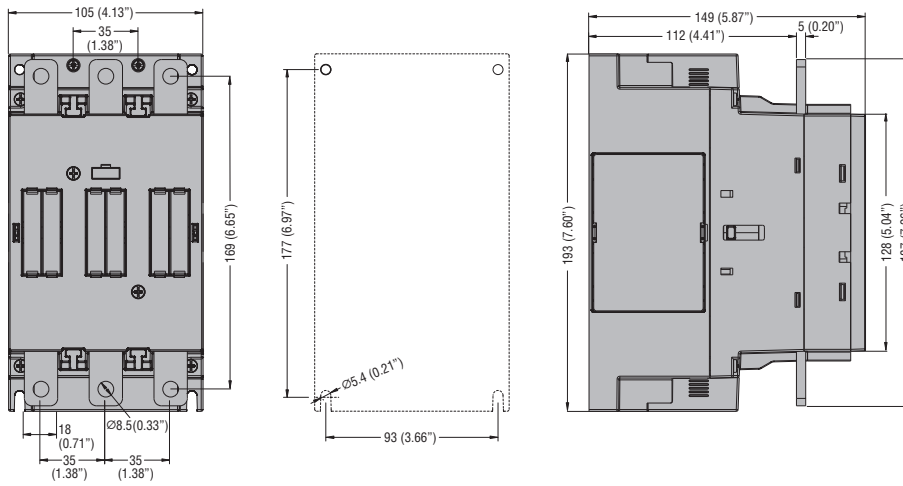

BF160T4E... - BF195T4E... - BF230T4E... four poles

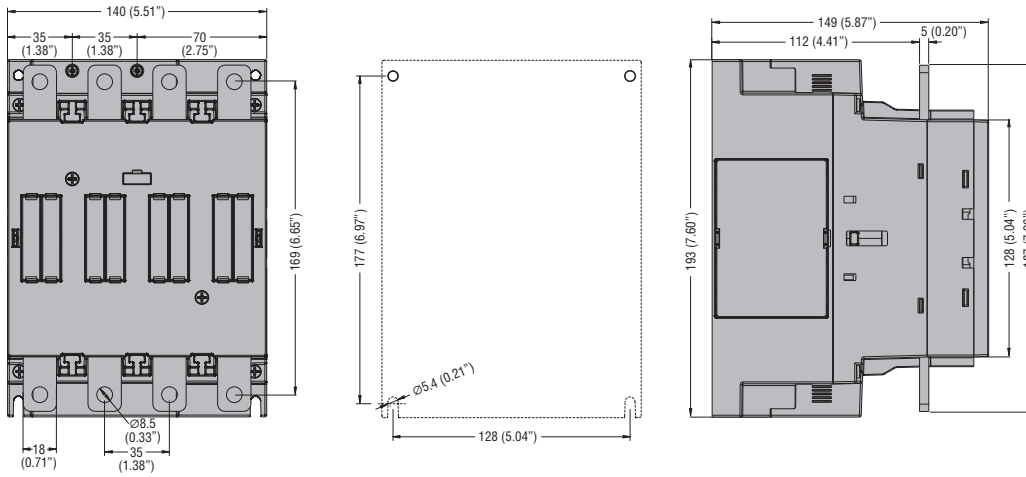

2 Contactors

Dimensions [mm (in)]

INDEX

B250 - B310 - B400 three poles with **RF...420** thermal overload relay

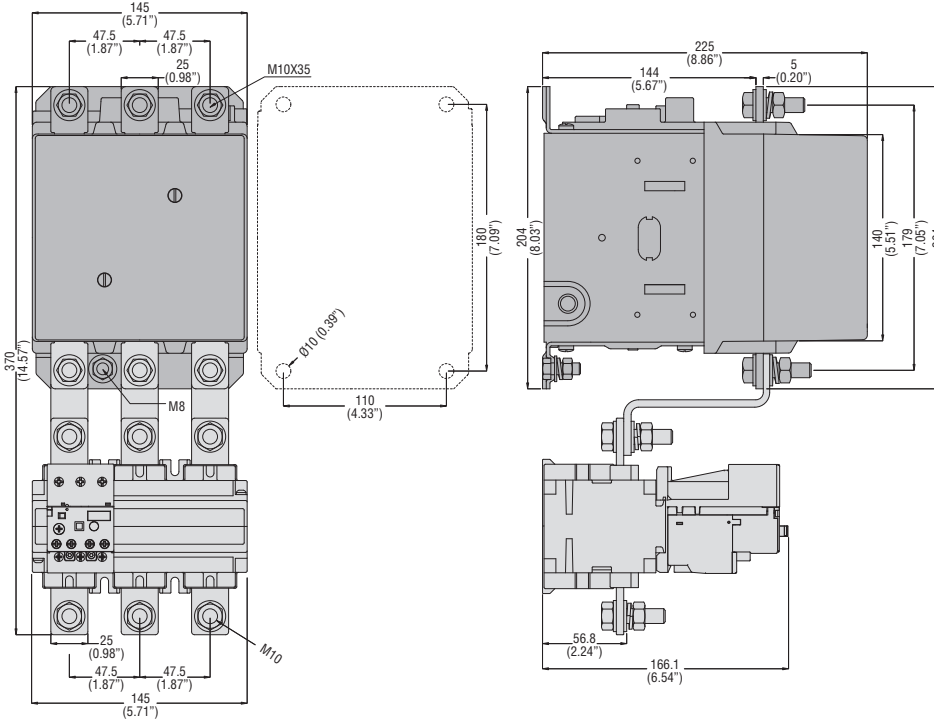

B2504 - B3104 - B4004 four poles

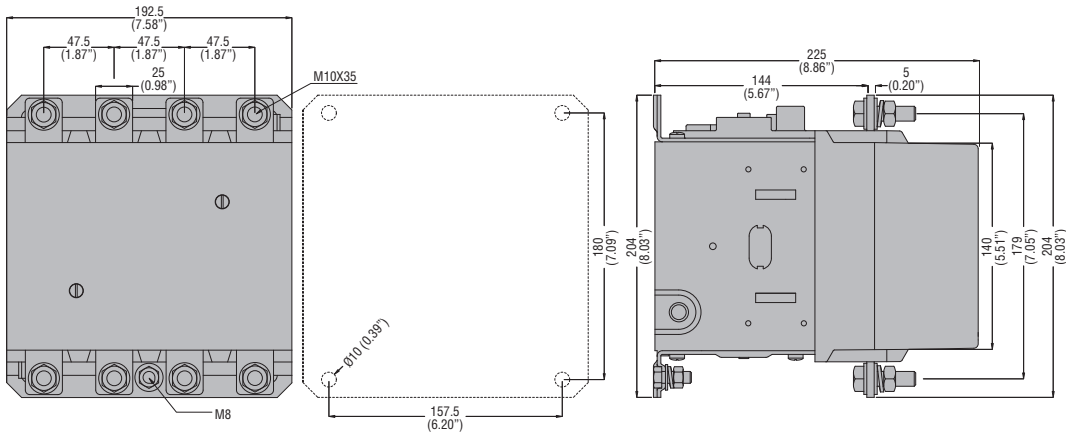

2 Contactors

Dimensions [mm (in)]

B500 - B630 three poles

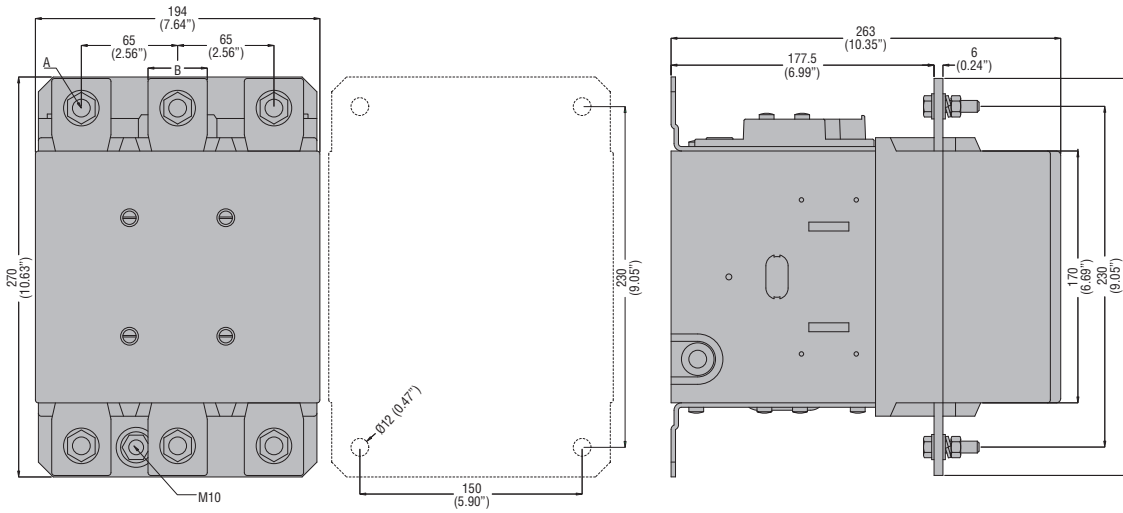

CONTACTOR TYPE	A	B	C
B500	M10	35 (1.38")	265 (10.43")
B630	M12	40 (1.57")	270 (10.63")

B5004 - B6304 four poles

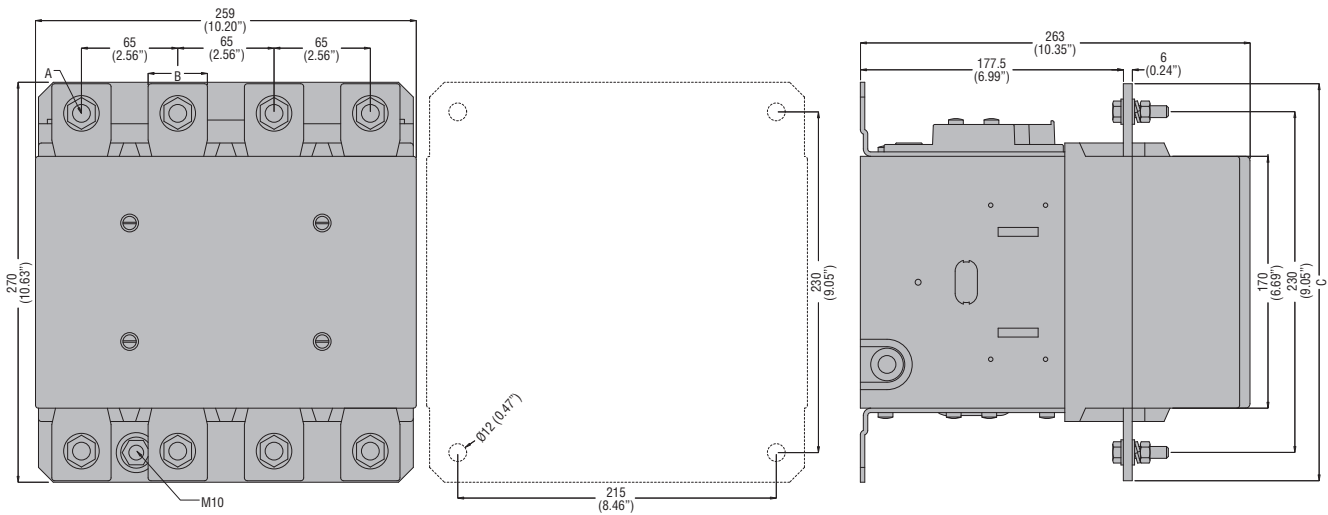

CONTACTOR TYPE	A	B	C
B500	M10	35 (1.38")	265 (10.43")
B630	M12	40 (1.57")	270 (10.63")

B6301000 three poles

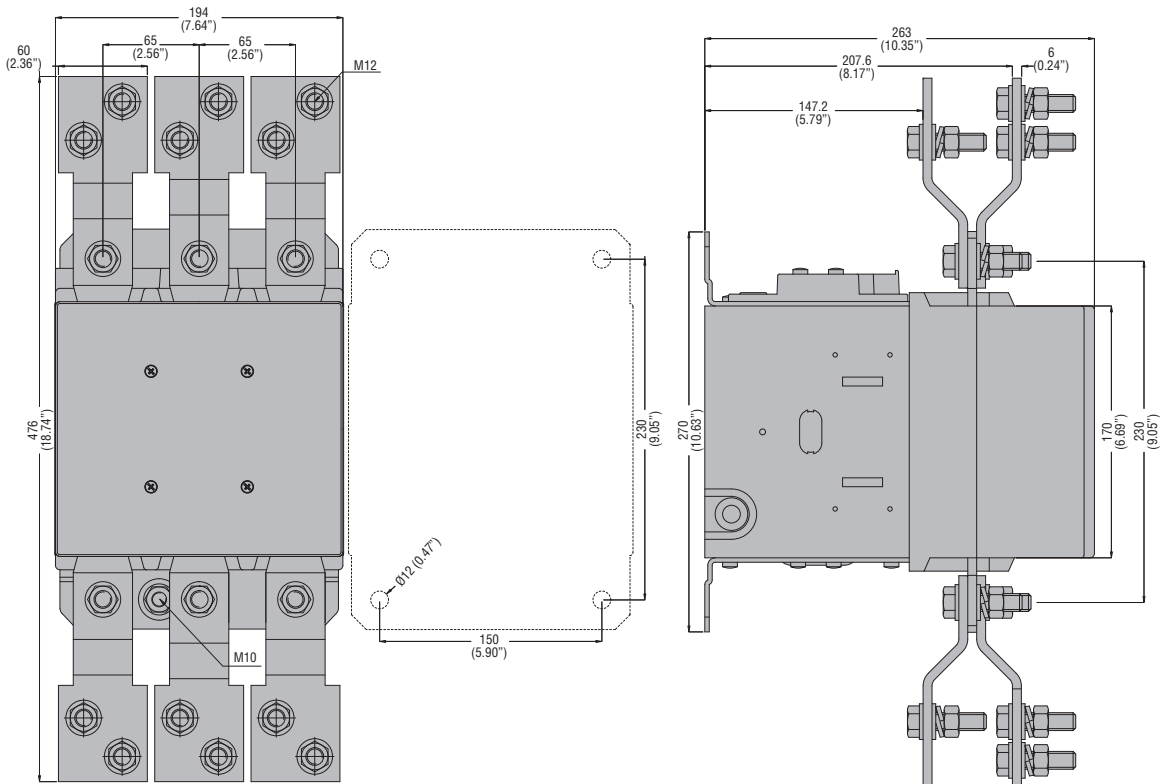

B6301004 four poles

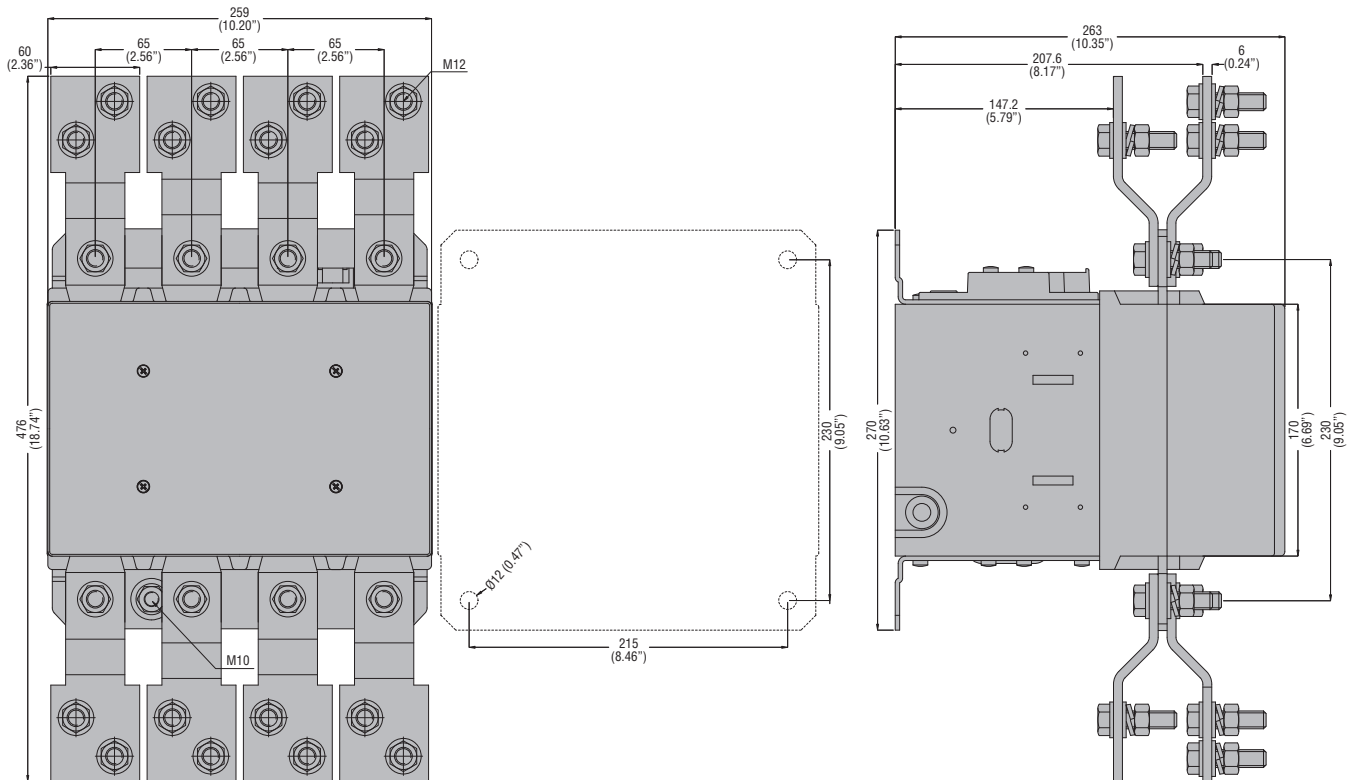

B1250 - B1600 three poles

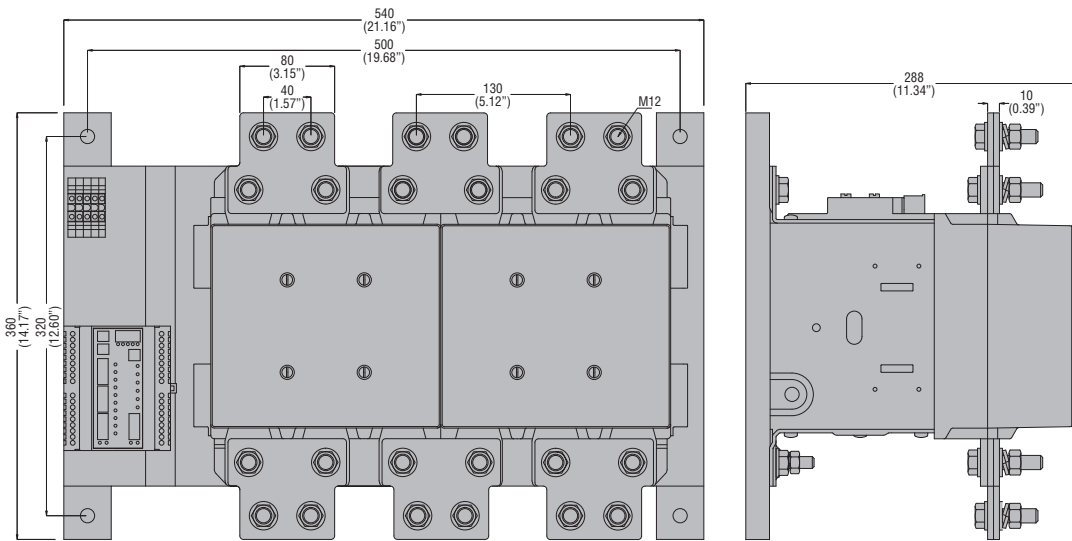

B12504 - B1600 four poles

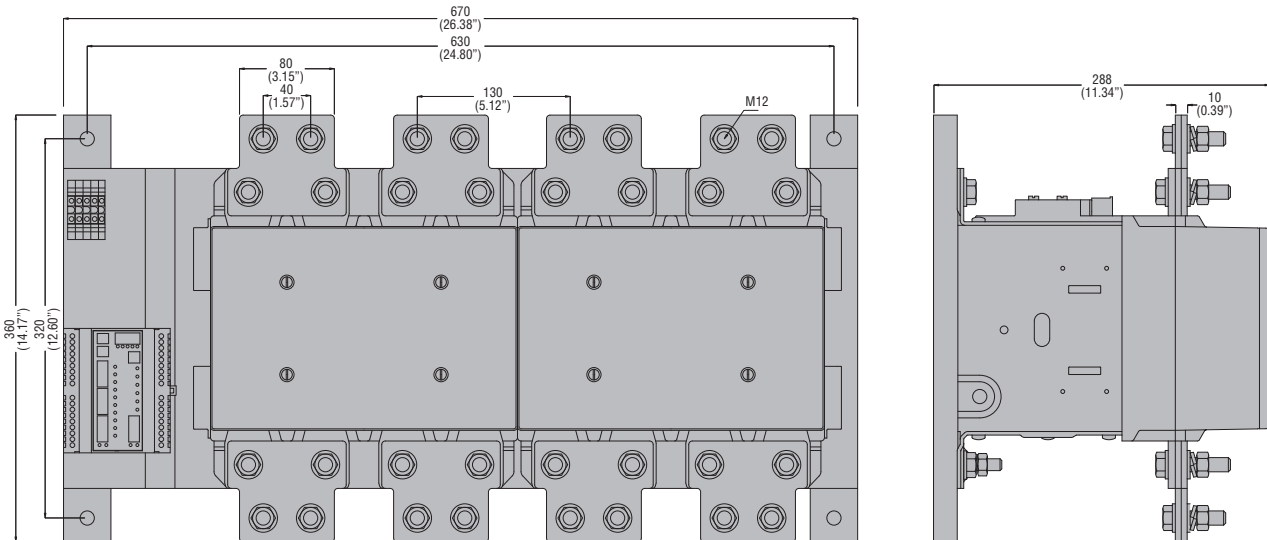

B250 - B310 - B400 - B500 - B630 - B6301000 - B1250 - B1600

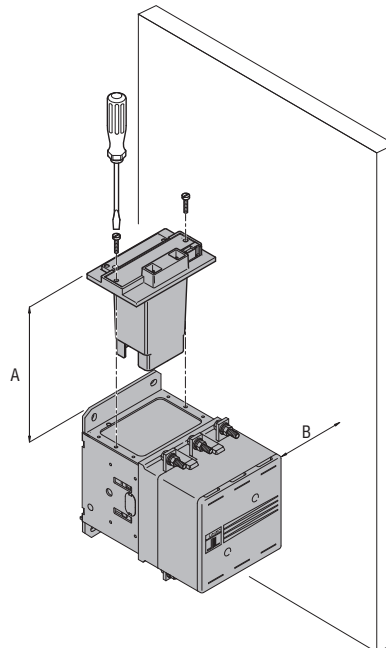
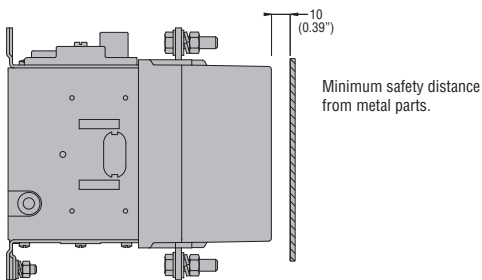

Minimum space needed to replace the coil.

	B250-B310-B400	B500-B630 1000
A	145 (5.71")	170 (6.69")
B	110 (4.33")	160 (6.30")

If dimension B is respected, coil replacement is possible without removing power wiring.

2 Contactors

Dimensions [mm (in)]

INDEX

CONTACTORS FOR POWER FACTOR CORRECTION

BFK0910A - BFK1210A - BFK1810A

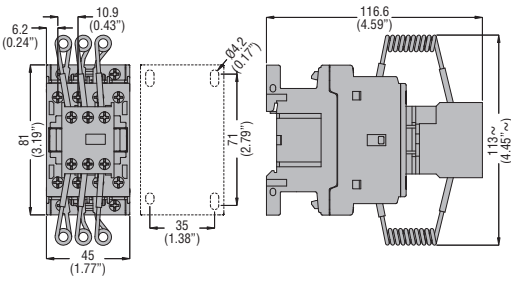

BFK2600A - BFK3200A - BFK3800A

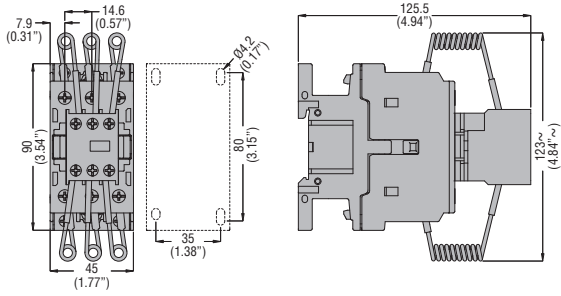

BFK50 - BFK65 - BFK80 - BFK94

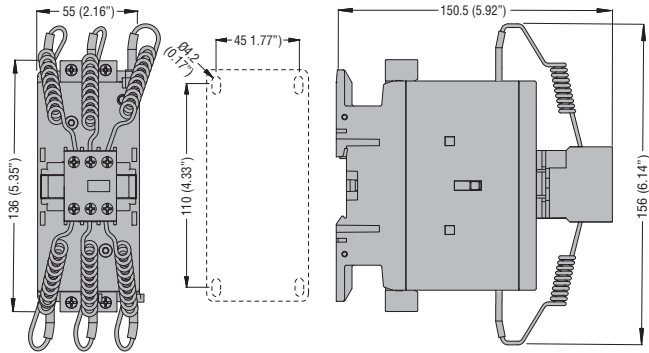

BFK95 - BFK115 - BFK150

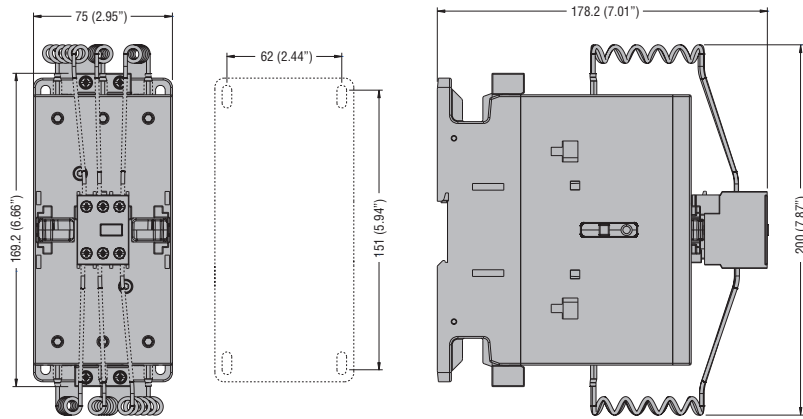

ADD-ON BLOCKS WITH BG MINI-CONTACTORS

BGX10... - BGF10... auxiliary contacts

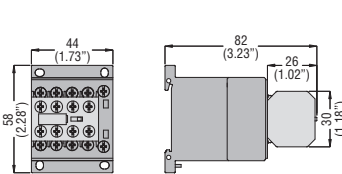

Valid for BGX11... contacts as well when mounted on left-hand contactor of BGT or BGC assembly (p. 4-5).

BGX5000 interlock with BGF10... contacts and BGX77... or BGX78... or BGX79... suppressor

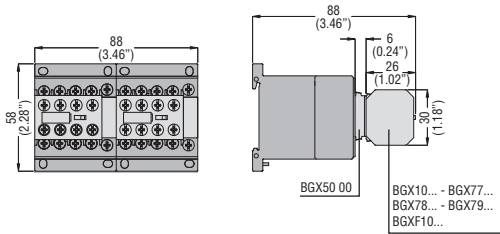

BGX77..., BGX78... or BGX79... suppressor only

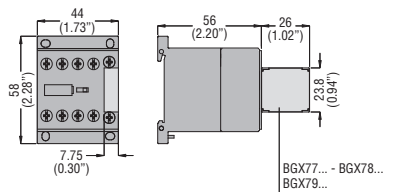

BGX8000 shroud

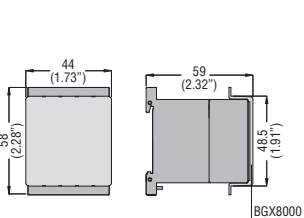

Paralleling links G323, G324

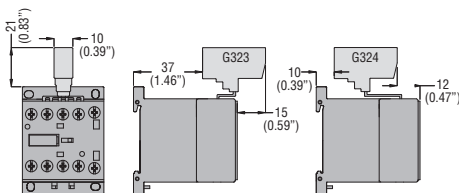

G325, G326

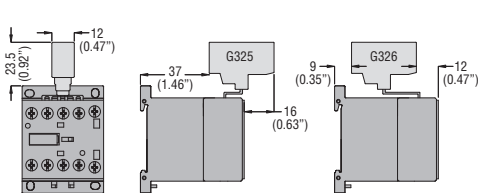

2 Contactors

Dimensions [mm (in)]

ADD-ON BLOCKS WITH BF CONTACTORS

Auxiliary contacts **BFX10...**
w/2 contacts

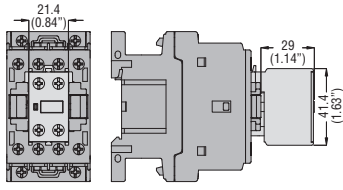

BFX10... w/4 contacts

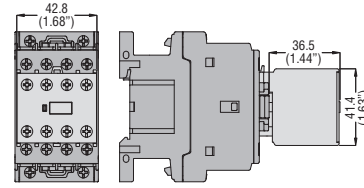

BFX12...

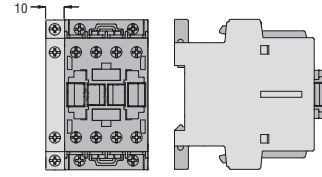

G484...

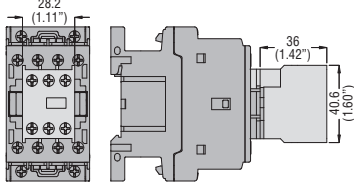

G418...

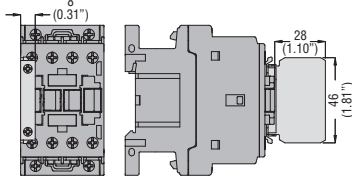

G218

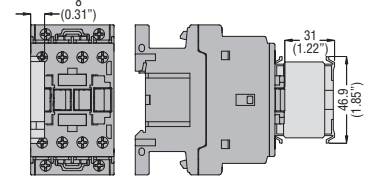

G481..., G482

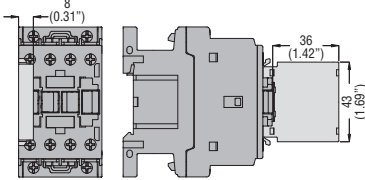

G280 with G218

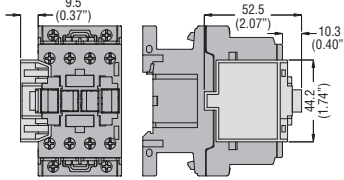

G419, with G418..., G428..., G483 with G481... or G482

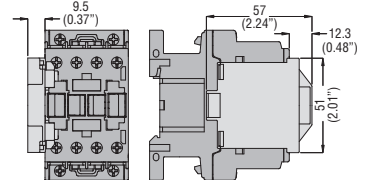

G485..., G486..., G487 delayed contacts

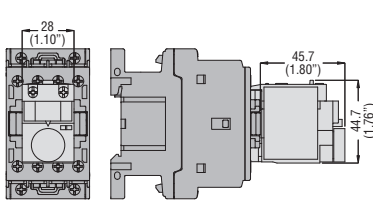

Fourth pole
BFX42

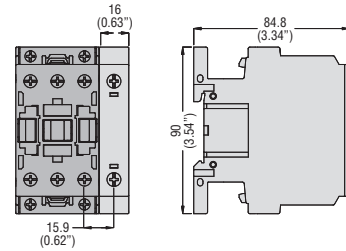

BFXD42

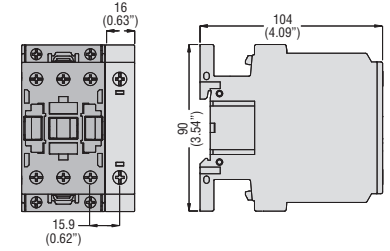

BFX43

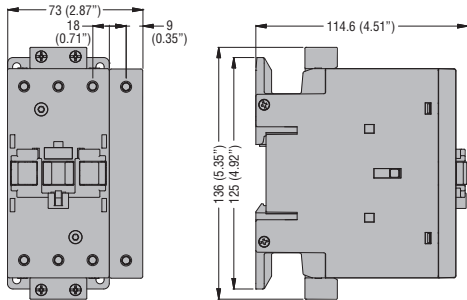

BFX44

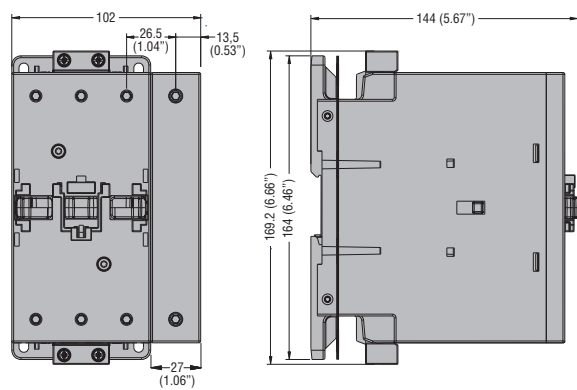

Mechanical interlocks

BFX5000, BFX5001, BFX5300, BFX5301, BFX5400, BFX5401

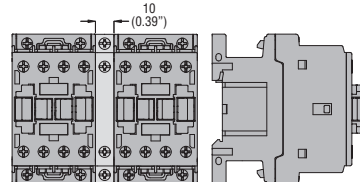

BFX5002

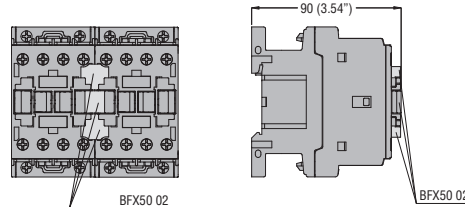

BFX5003, BFX5303, BFX5403

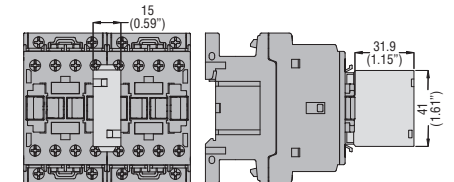

2 Contactors

Dimensions [mm (in)]

Mechanical interlocks

BFX5303 - BFX5403

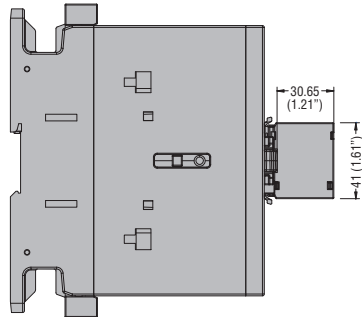
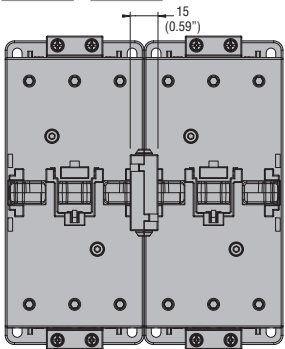

G222, G272, BFX641 mechanical latch

G454, G455, BF642 manual closing

BFX80 sealing cover

Rigid connecting kit
90mm (3.54") with **BFX5000** and **BFX5001**
100mm (3.94") with **BFX5002** and **BFX5003**

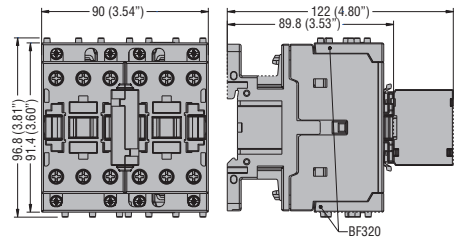
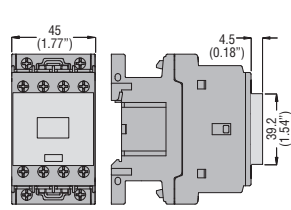
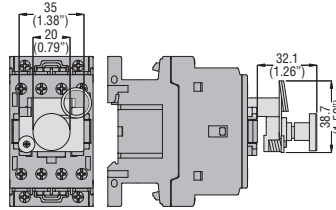
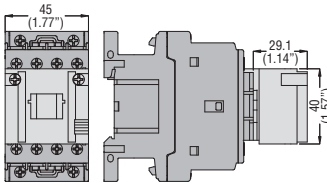

G231 terminal
1-pole

G232 terminal
1-pole

BFX8901 fixing base

BFX8902 fixing brackets

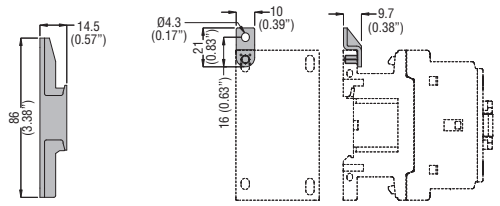
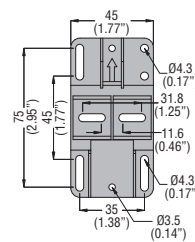
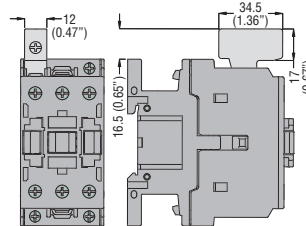
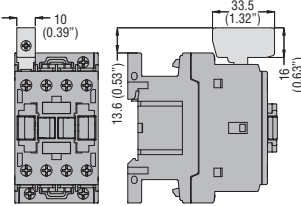

Rigid connecting kit

BFX3101

BFX3102

BFX3201

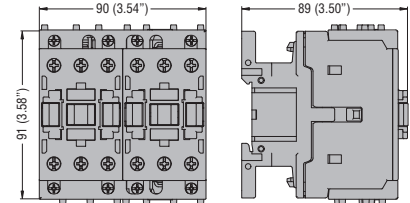
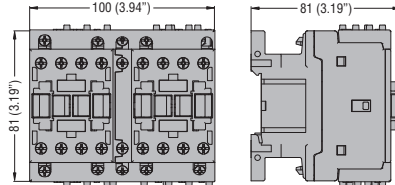
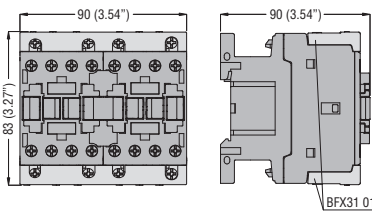

BFX3301

BFX3401

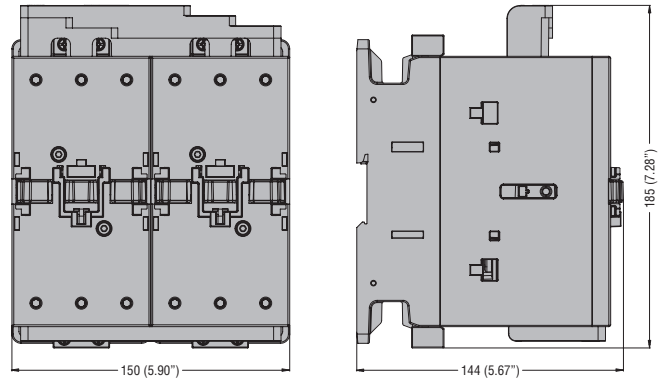
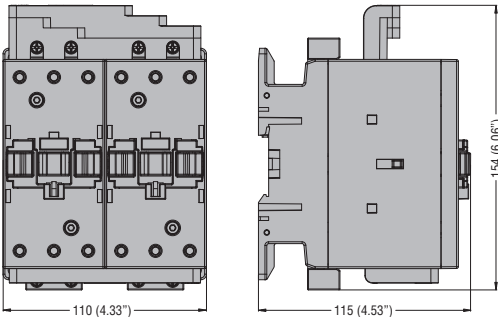

BFX3131

BFX3232

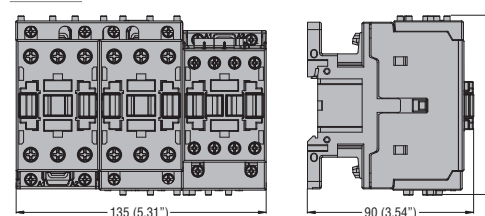
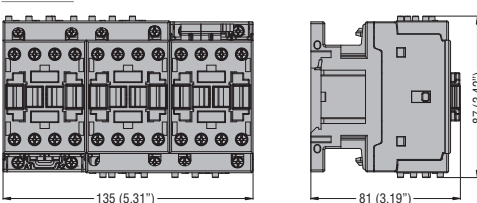

2 Contactors

Dimensions [mm (in)]

BFX3231

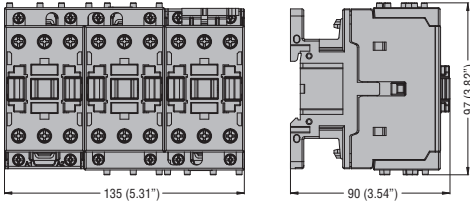

BFX3332

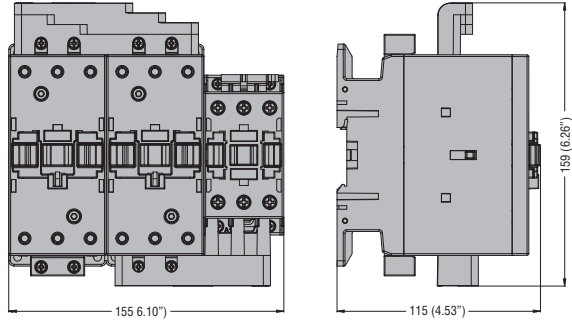

BFX3331

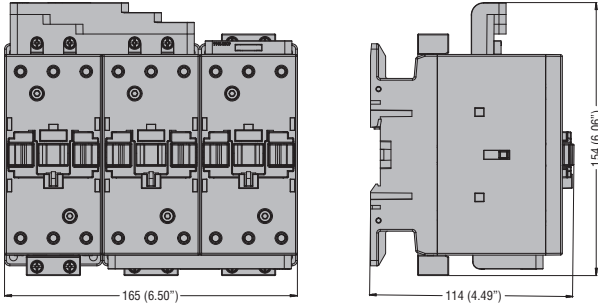

BFX3432

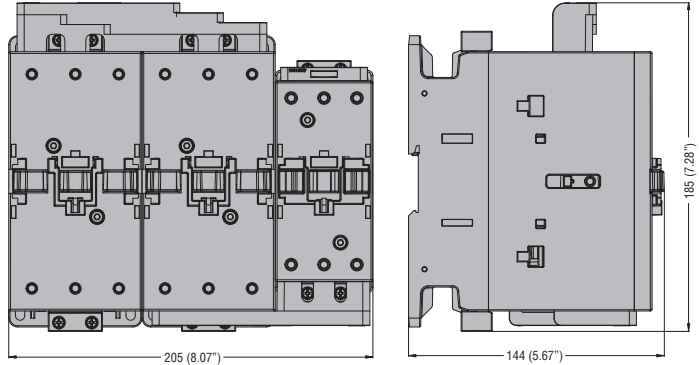

BFX3431

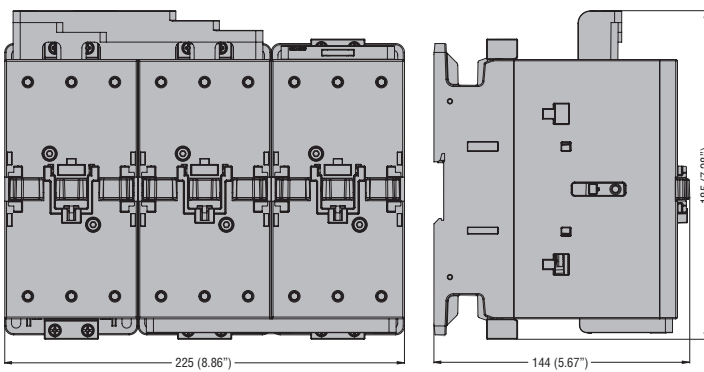

BFX3361

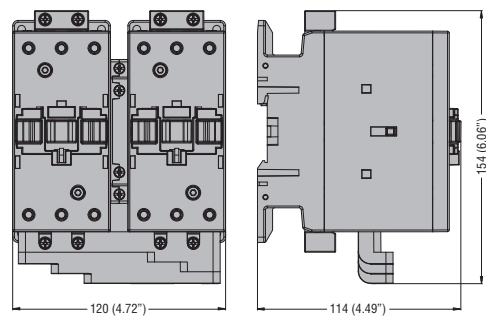

BFX3461

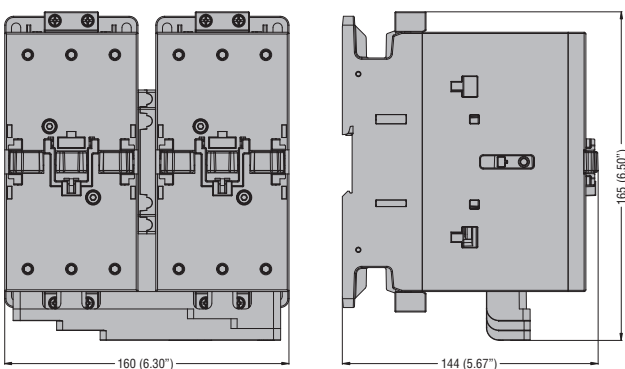

BFX3371

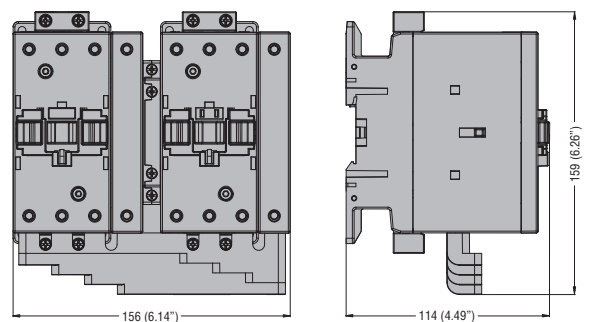

BFX3471

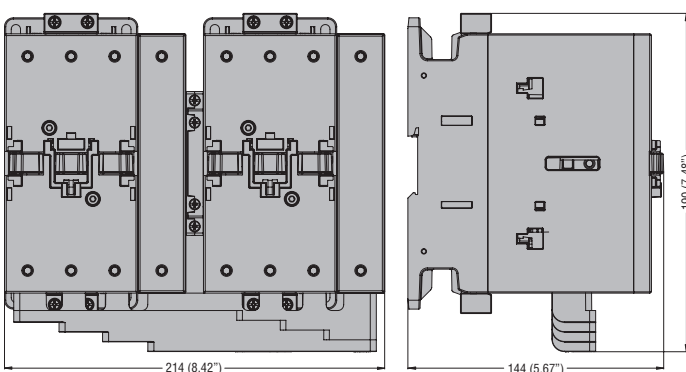

2 Contactors

Dimensions [mm (in)]

INDEX

ADD-ON BLOCKS WITH BF160...BF230 CONTACTORS

BFX10C..., **BFX12C...** auxiliary contacts

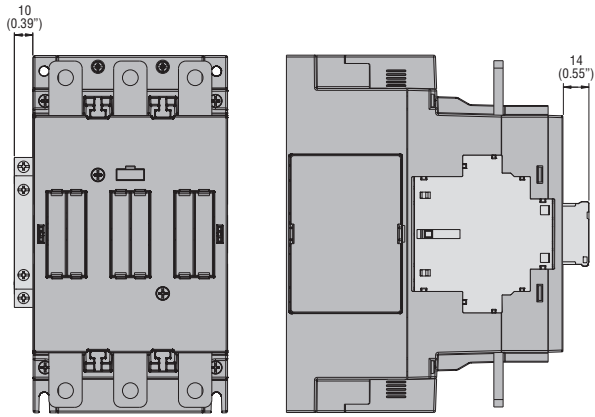

BFX5500 interlock

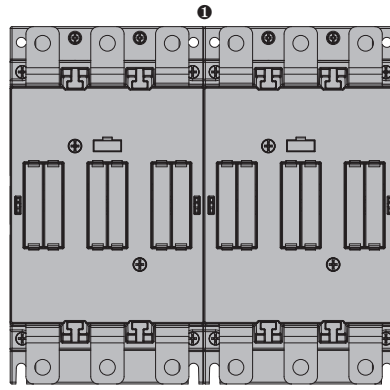

❶ The BFX5500 interlock is mounted inside the 2 contactors without dimensions increasing.

BFX5503, **BFX5504** interlocks

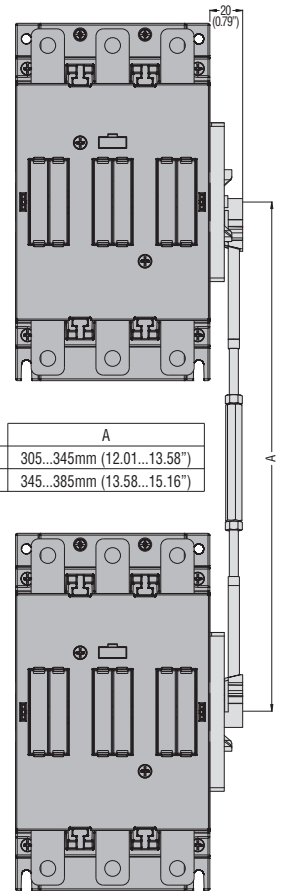

	A
BFX5503	305...345mm (12.01...13.58")
BFX5504	345...385mm (13.58...15.16")

Terminal protection

BFX835 - BFX845

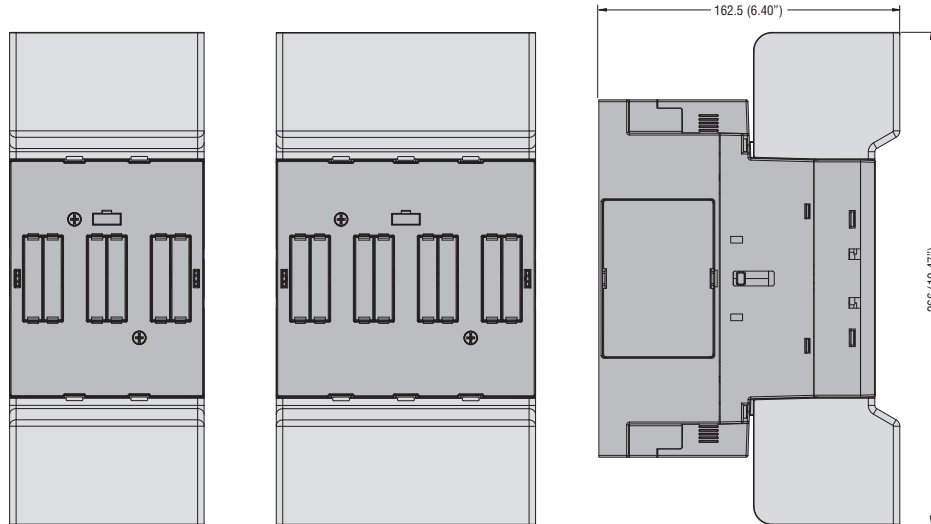

Phase barrier

BFX805

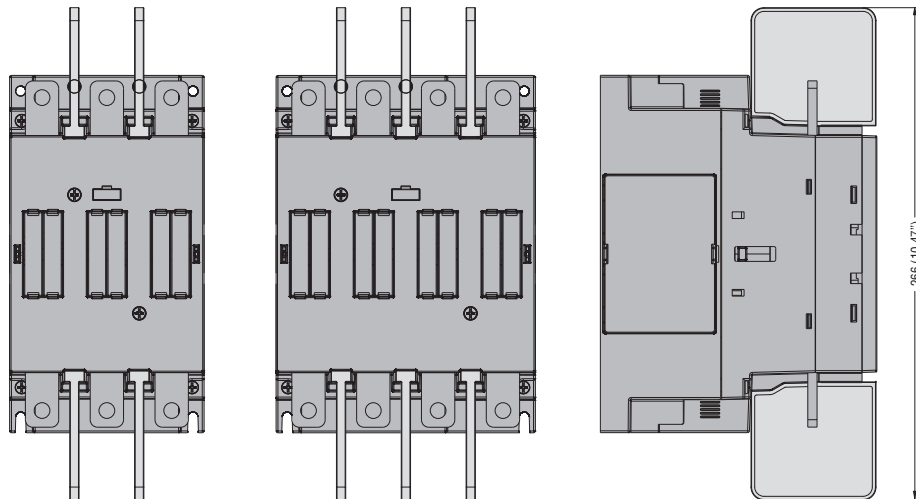

ADD-ON BLOCKS WITH B CONTACTORS

Auxiliary contacts **G350, G354**

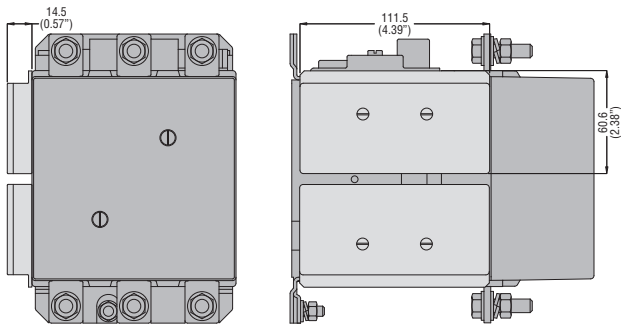

G358 adapter

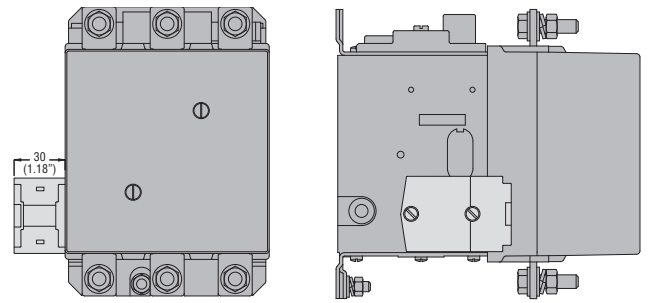

2

G355 interlocks

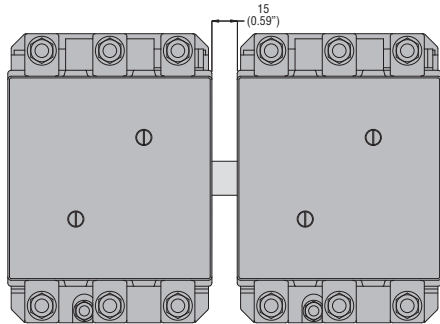

G356...

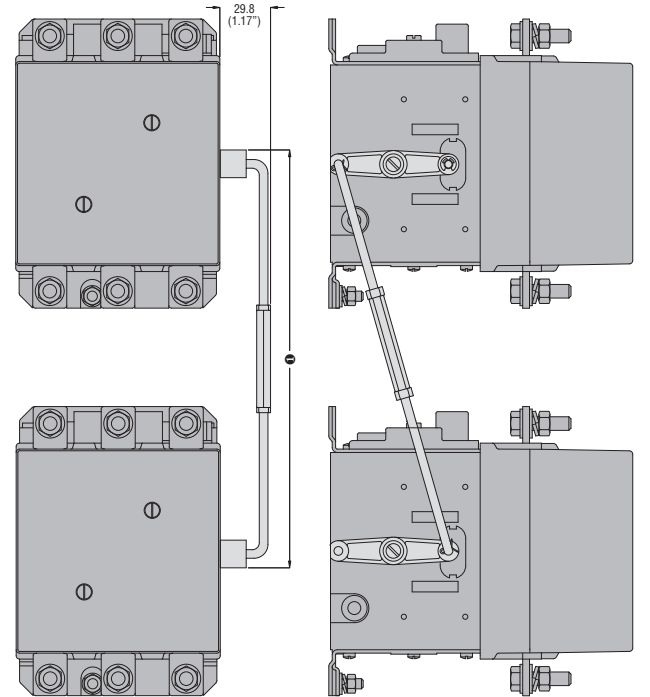

Terminal protection **G361**

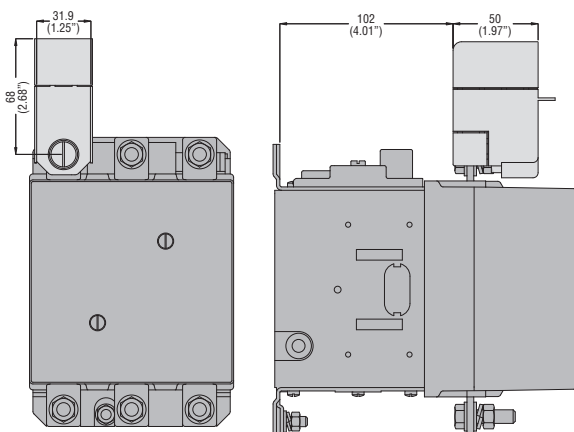

❗ For dimensions, refer to page 2-68 to 2-76.

Terminal protection

G363

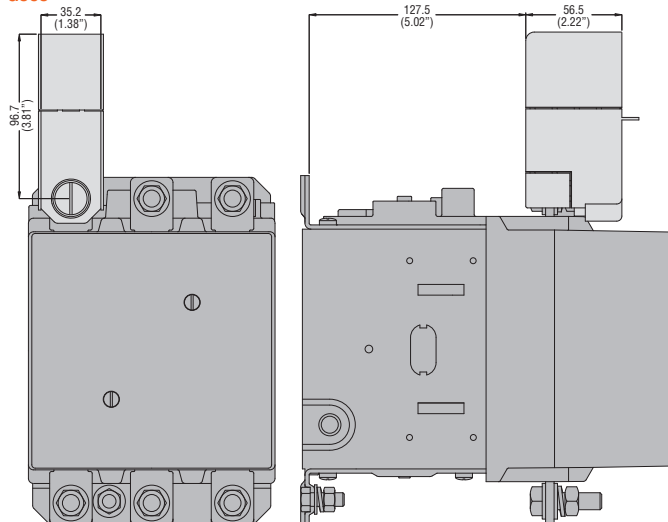

G527, G529

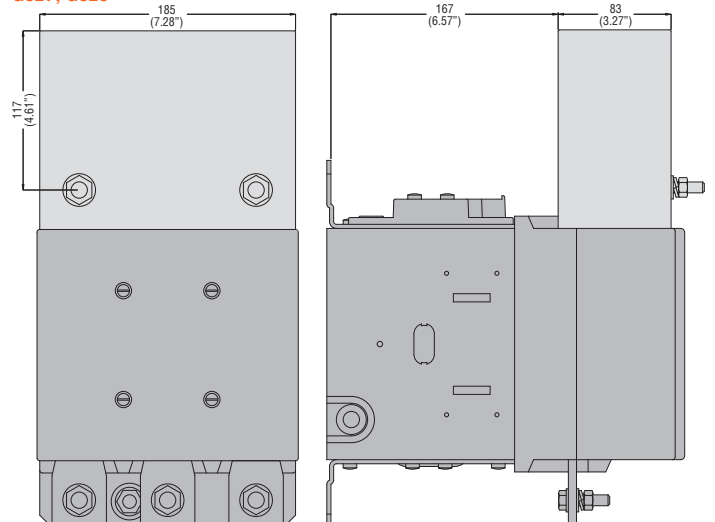

G528, G530

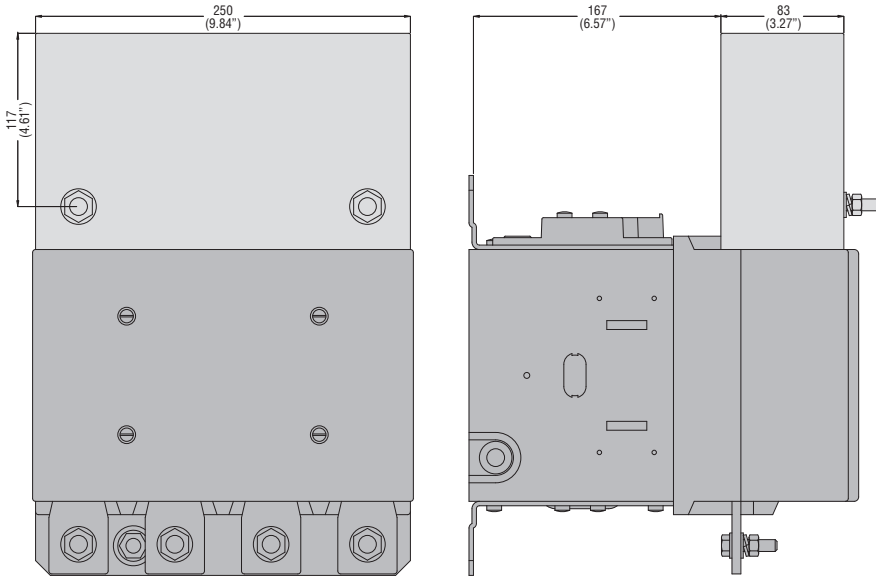

BA1594, BA1720 parallel 2-pole bar

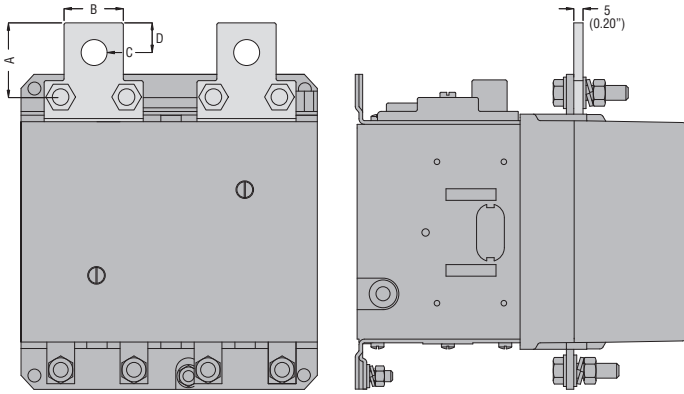

G495 mechanical latch

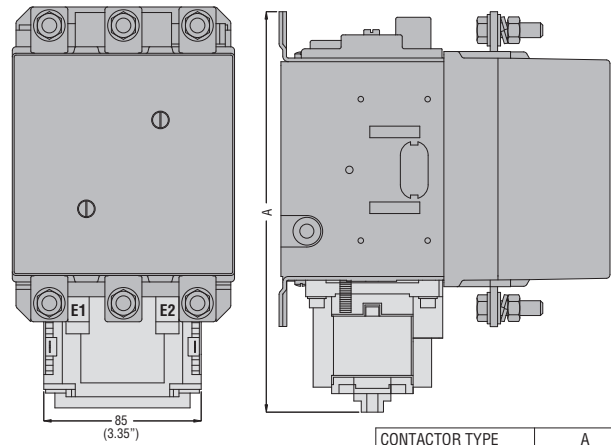

PARALLEL POLE BAR	A	B	C	D
BA1594	45 (1.77")	32 (1.26")	Ø14 (0.55")	16 (0.63")
BA1720	53 (2.09")	50 (1.97")	Ø18 (0.71")	20 (0.79")

CONTACTOR TYPE	A
B250 - B400	255 (8.86")
B500 - B630	300 (11.81")

BA1845

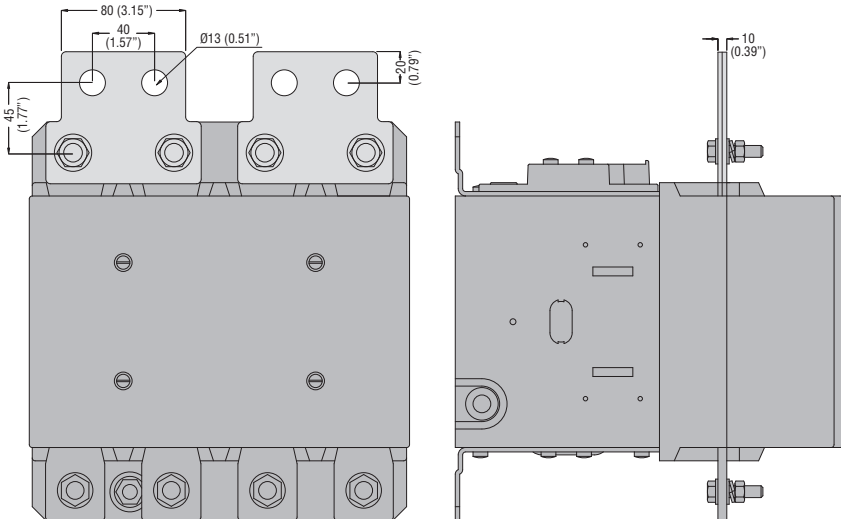

THREE-POLE CONTACTORS IN AC
BG06A - BG09A - BGF09A - BGP09A - BG12A
BF09A - BF12A - BF18A - BF25A

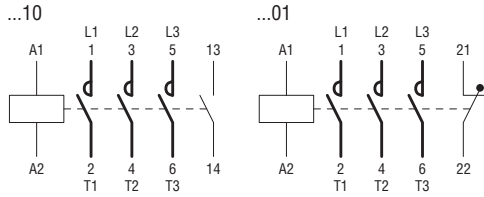

BF26A - BF32A - BF38A
BF40A - BF50A - BF65A - BF80A
BF94A - BF95A - BF115A - BF150A
B250...B630

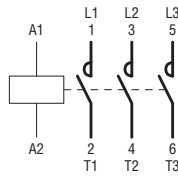

B125024 - B160024... ①

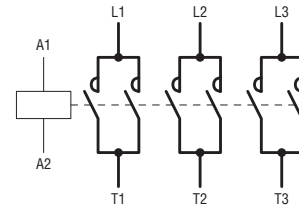

① The input electronic circuit of the contactor coil is designed and tested according to IEEEC 62.41 standards and can withstand a 10kV impulse voltage (1.2/50µs) with 50 Joule energy. The use of an auxiliary reduced voltage transformer is recommended for higher values.

THREE-POLE CONTACTORS IN DC (AC/DC for BF40E...BF230E)

BG06D - BG09D - BGF09D - BGP09D - BG12D
BG06L - BG09L - BGF09L - BGP09L - BG12L

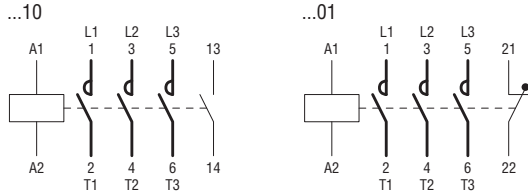

BF09D - BF12D - BF18D - BF25D
BF09L - BF12L - BF18L - BF25L

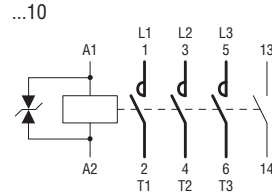

BF26D - BF32D - BF38D
BF26L - BF32L - BF38L

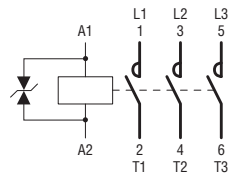

BF40E - BF50E - BF65E - BF80E - BF94E
BF95E - BF115E - BF150E - BF160E - BF195E - BF230E

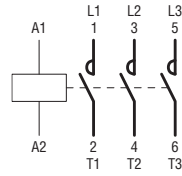

CONTACTORS FOR POWER FACTOR CORRECTION

BFK09A - BFK12A - BFK18A
BFK26A - BFK32A - BFK38A - BFK50A - BFK65A - BFK80A - BFK94A - BFK95A - BFK115A - BFK150A

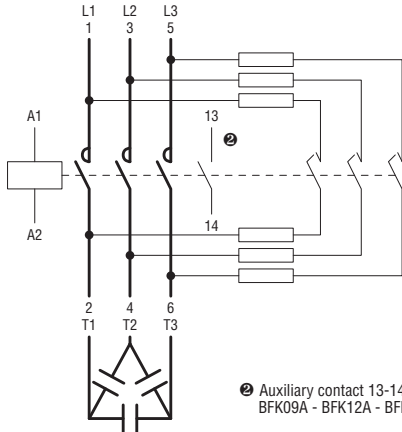

② Auxiliary contact 13-14 is found on BFK09A - BFK12A - BFK18A types only.

FOUR-POLE CONTACTORS IN AC
BG09T4A - BGF09T4A - BGP09T4A
BF09T4A - BF38T4A
BF50T4A - BF65T4A - BF80T4A
BF95T4A - BF115T4A - BF150T4A
BFD80T4A
B250...B6304

B12504 - B16004

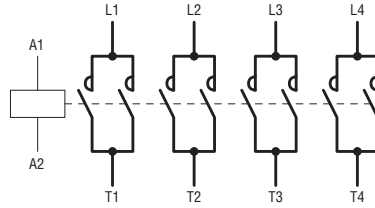
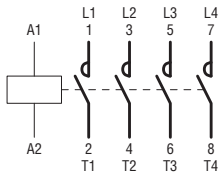

FOUR-POLE CONTACTORS IN DC (AC/DC for BF65T4E...BF150T4E)
BG09T4D - BGF09T4D - BGP09T4D
BF09T4D - BF38T4D
BF09T4L - BF38T4L

BF65T4E - BF80T4E - BF95T4E - BF150T4E - BFD150T4E
BF160T4E - BF195T4E - BF230T4E

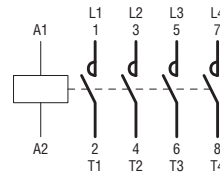
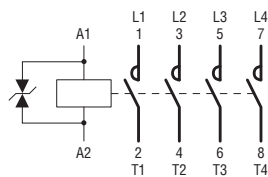
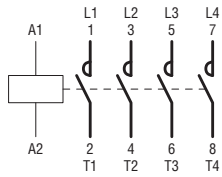

FOUR-POLE CONTACTORS IN AC WITH 2NO AND 2NC POLES
BG09T2A

BF09T2A - BF18T2A - BF26T2A - BF38T2A
BF80T2A

WITH NC FOUR-POLES
BF18T0A - BF26T0A

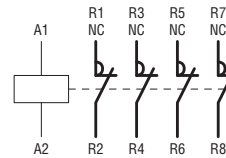
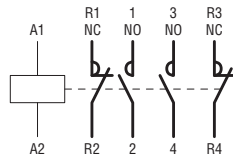
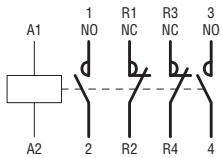

FOUR-POLE CONTACTORS IN DC (AC/DC for BF80T2E) WITH 2NO AND 2NC POLES
BG09T2D

BF18T2D - BF26T2D - BF38T2D
BF18T2L - BF26T2L - BF38T2L

BF80T2E

WITH NC FOUR-POLES
BF18T0D - BF26T0D
BF18T0L

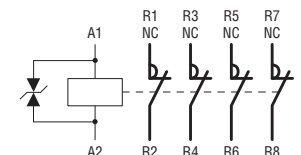
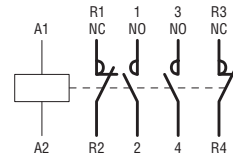
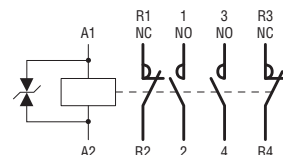
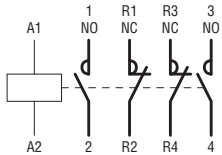

CONTROL RELAY IN AC
BG0040A - BGF0040A
BF0040A

BG0031A - BGF0031A
BF0031A

BG0022A - BGF0022A
BF0022A

BF0004A

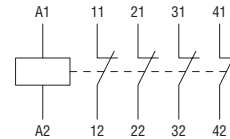
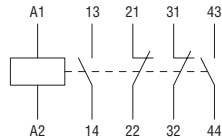
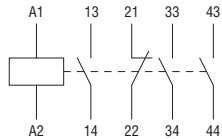
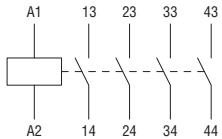

CONTROL RELAY IN DC
BG0040D - BGF0040D
BG0040L - BGF0040L

BG0031D - BGF0031D
BG0031L - BGF0031L

BG0022D - BGF0022D
BG0022L - BGF0022L

BF0004D
BF0004L

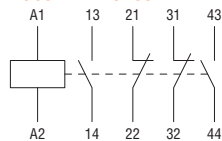
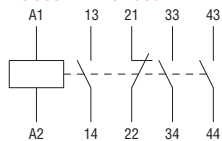
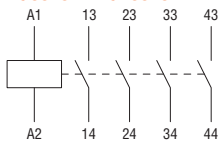

BF0040D
BF0040L

BF0031D
BF0031L

BF0022D
BF0022L

BF0004D
BF0004L

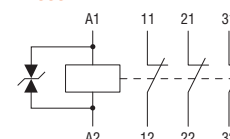
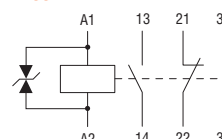
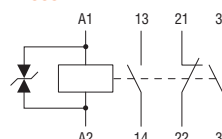
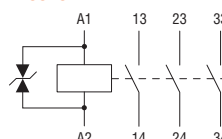

ADD-ON BLOCKS FOR BG MINI-CONTACTORS

Auxiliary contacts

BGX1002
BGXF1002

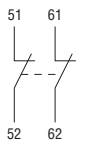

BGX1011
BGXF1011

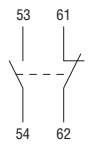

BGX1020
BGXF1020

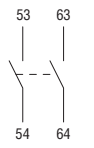

BGX1004
BGXF1004

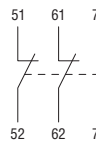

BGX1013
BGXF1013

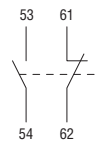

BGX1022
BGXF1022

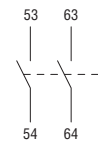

BGX1031
BGXF1031

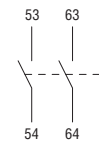

BGX1040
BGXF1040

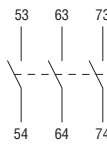

Special auxiliary contacts

BGX1111

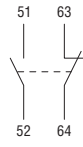

BGX1122



Surge suppressor

BGX77...

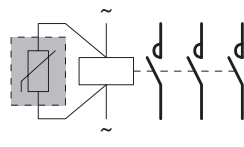

BGX78...

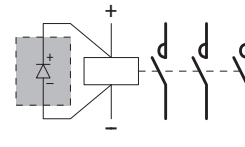

BGX79...

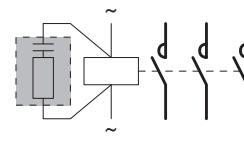

Rigid connections

SMX9021

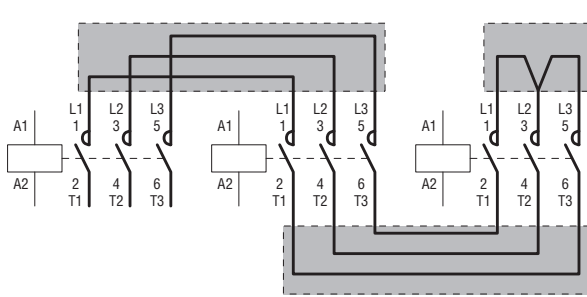

SMX9022

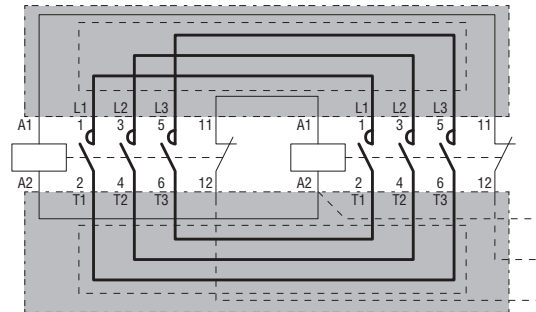

ADD-ON BLOCKS FOR BF CONTACTORS

Auxiliary contacts

BFX1002

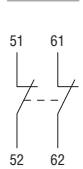

BFX1011

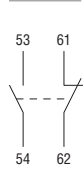

BFX1020



G48430

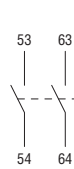

G48421

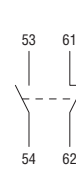

G48412

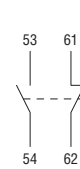

G48403

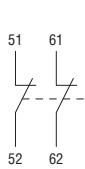

BFX1004

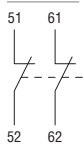

BFX1013

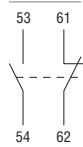

BFX1022

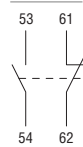

BFX1031

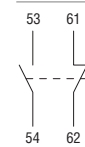

BFX1040

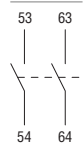

BFX101111

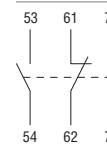

Auxiliary contact

G218

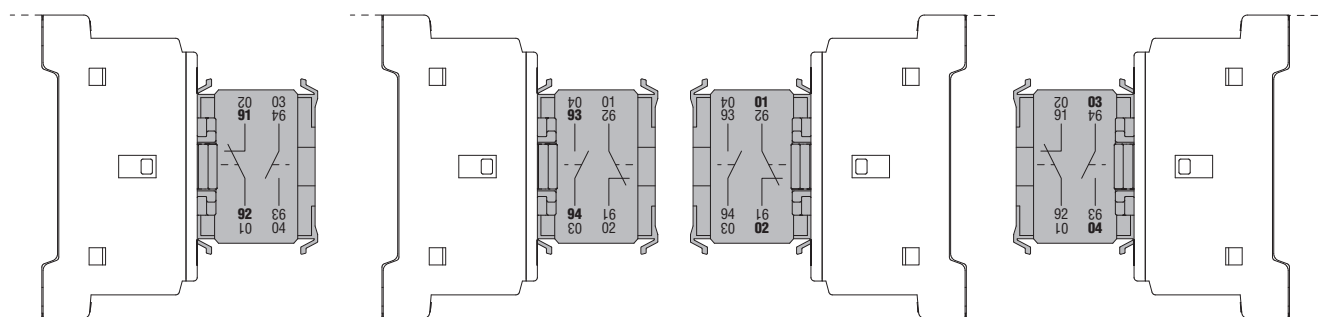

The termination of the G218 auxiliary contact has more than one numbering due to the fact that the block can assume various mounting positions. See the numbering in boldface for a correct interpretation.

2 Contactors

Wiring diagrams

Auxiliary contacts

BFX1202
BFX12C02

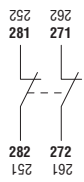

BFX1211
BFX12C11

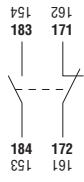

BFX1220
BFX12C20

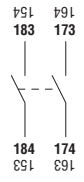

BFX10C10



BFX10C01



G41810
G42810



G41810A
G42810A



G41801
G42801



G41801D
G42801D



G48120

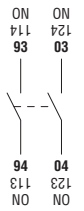

G48111

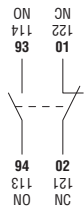

G48102

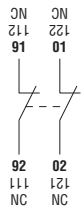

G482

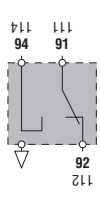

Mechanical latch

G222... - G272... - BFX641...

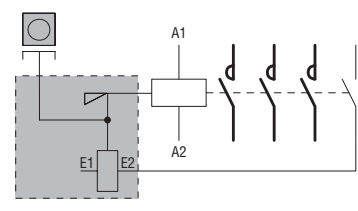

The termination of the BFX12... / G418... / G481... / G482 auxiliary contacts has more than one numbering due to the fact that the block can assume various mounting positions. See the numbering in boldface when the block is mounted on the left side of the contactor.

4th pole

BFX42 - BFX43 - BFX44
BFXD42



Interlock

BFX5001 - BFX5301
BFX5401

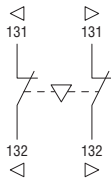

Delayed auxiliary contacts

G485... **G486... - G487**

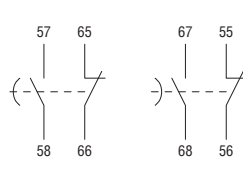

Rigid connecting kits

BFX3101 - BFX3102 - BFX3201
BFX3301 - BFX3401

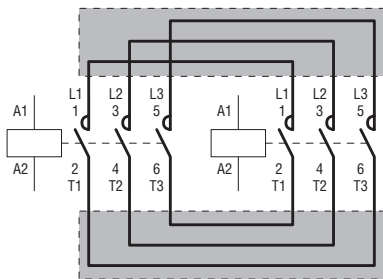

BFX3131 - BFX3231 - BFX3232 - BFX3331 - BFX3332 - BFX3431 - BFX3432

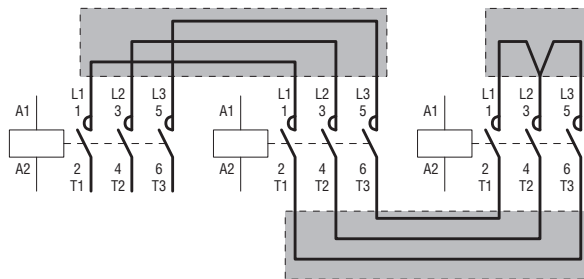

BFX3361 - BFX3461

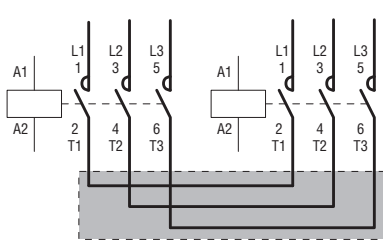

BFX3371 - BFX3471

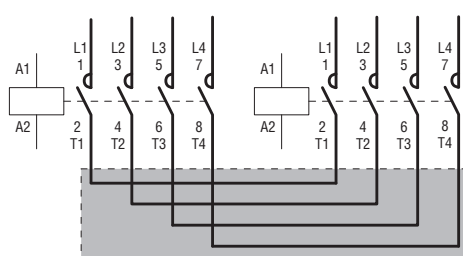

ADD-ON BLOCKS FOR B CONTACTORS
Auxiliary contacts
G350 - G354

G354

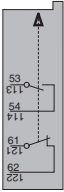

or

G350

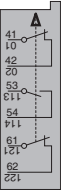

or

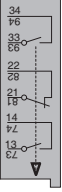

G354

G350

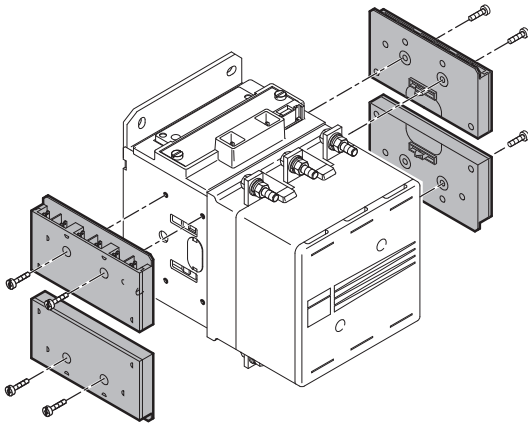

G350

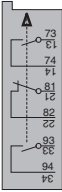

or

G354

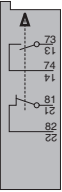

G350

G354

Mechanical latch
G495

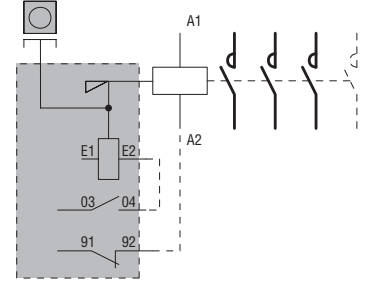

MOUNTING POSITION OF CONTACTORS

ON VERTICAL PLANE

The performances given in this catalogue have been established with contactors mounted on a vertical plane with line terminals facing upwards and load terminals facing downwards.

All contactors can be mounted with a $\pm 30^\circ$ inclination to the vertical axis of the contactor without any derating.

For BF series contactors, this inclination can reach $\pm 90^\circ$, that is when the terminals are facing towards left and right.

For BG mini-contactors:

- Position A, with coil terminals A1-A2 facing downwards, is not recommended.
- The position with coil terminals A1-A2 facing upwards is not recommended for mini-contactors with NC contacts.



ON VERTICAL PLANE WITH 30° INCLINATION

All contactors can be mounted on a plane which varies in respect to the vertical up to $\pm 30^\circ$ angle.

On the average, a 5% increase of the minimum pick-up voltage in -30° position can be noted.

This inclination is greater than the one prescribed by main naval registers.

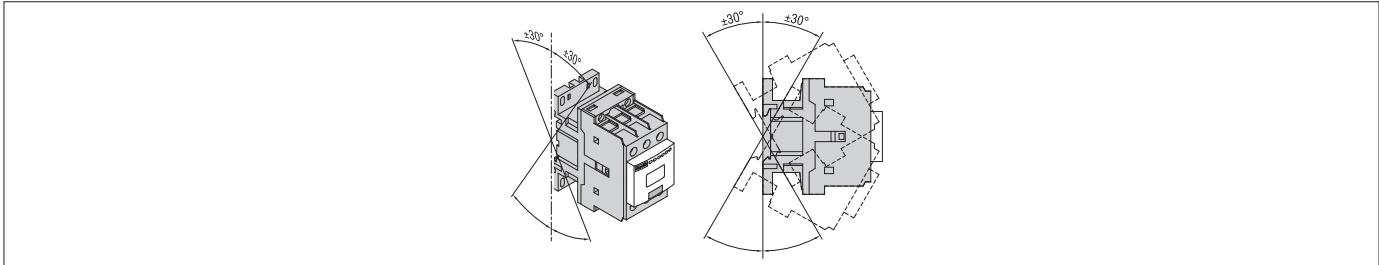

ON HORIZONTAL PLANE (FOR BF SERIES CONTACTORS)

Considerable performance variations can be noted.

It is necessary to check the two possible mounting positions:

- when the contactor is energised, the movable equipment moves upwards.
- when the contactor is energised, the movable equipment moves downwards.

In the first case, it is difficult to close the contactor while in the second, to open it.

The variables which could influence the contactor performance, in addition to the two mounting positions, are:

- type of contactor
- type of control
- contact configuration
- number and type of add-on blocks
- permissible tolerance of auxiliary voltage variation
- ambient temperature.

NOTE: Position B is not recommendable.

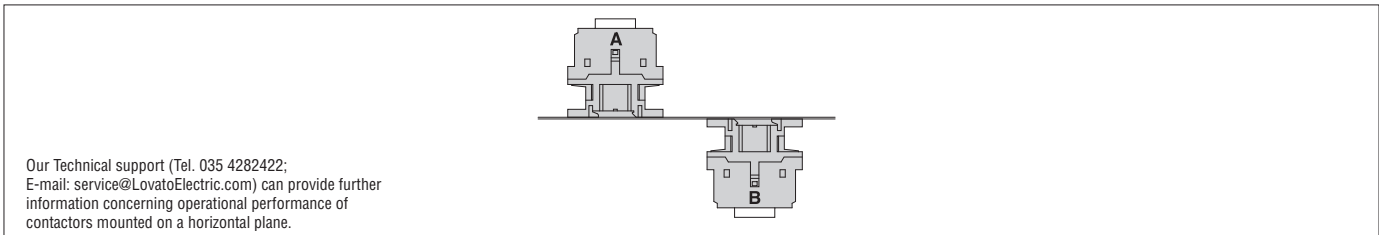

Our Technical support (Tel. 035 4282422; E-mail: service@LovatoElectric.com) can provide further information concerning operational performance of contactors mounted on a horizontal plane.

DYNAMIC TYPE TESTS

Our contactors have sustained dynamic testing, with contactor mounting position rotated $\pm 22.5^\circ$ in respect to the three orthogonal axes.

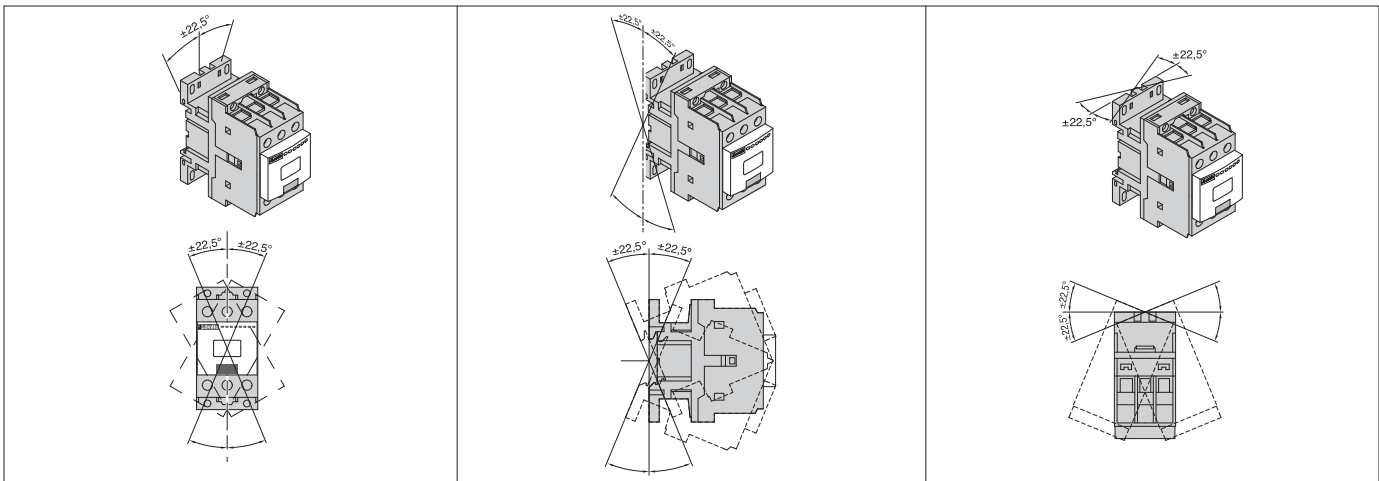

IEC UTILISATION CATEGORY AC3

POLE CHARACTERISTICS

Squirrel-cage induction motors; breaking at rated motor current.

MAXIMUM IEC OPERATIONAL POWER at ambient temperature $\leq 55^{\circ}\text{C}$.

Contactor type	IEC operational current (U _e \leq 440V) [A]	IEC operational power							Maximum horsepower ratings (60Hz)			
		220/230V [kW]	380/400V [kW]	415V [kW]	440V [kW]	500V [kW]	660/690V [kW]	1000V [kW]	Three phase 200-208V [HP]	240V [HP]	480V [HP]	600V [HP]
BG06	6	1.5	2.2	2.4	2.5	3	3	-	1½	2	3	3
BG09	9	2.2	4.0	4.3	4.5	5	5	-	2	3	5	5
BG12	12	3.2	5.7	6.2	5.5	5	5	-	3	3	7½	10
BF09	9	2.2	4.2	4.5	4.8	5.5	7.5	-	3	3	5	7 ½
BF12	12	3.2	5.7	6.2	6.2	7.5	10	-	5	5	7½	10
BF18	18	4	7.5	9	9	10	10	-	5	5	10	15
BF25	25	7.0	12.5	13.4	13.4	15	18	-	7½	7½	15	15
BF26	26	7.3	13	14	14	15.6	18.5	-	7½	7½	15	20
BF32	32	8.8	16	17	17	20	22	-	10	10	20	25
BF38	38	11	18.5	18.5	18.5	20	22	-	10	15	30	30
BF40	40	11	18.5	22	22	22	30	18	10	15	30	30
BF50	50	15	22	30	30	30	37	22	15	20	40	40
BF65	65	18.5	30	37	37	37	45	30	20	25	50	60
BF80	80	22	45	45	45	55	55	37	25	30	60	75
BF94	95	30	55	55	55	55	55	37	25	30	60	75
BF95	95	30	55	55	55	75	90	45	30	30	60	75
BF115	115	37	55	55	55	75	110	55	40	40	75	100
BF150	150	45	75	75	75	90	110	55	50	50	100	125
BF160	160	45	75	90	90	110	132	75	50	50	100	125
BF195	195	55	90	110	110	132	160	90	60	75	150	150
BF230	230	55	110	110	132	132	160	110	75	75	150	200
B250	265	83	140	155	164	176	212	156	75	100	200	250
B310	320	100	170	188	200	213	256	180	100	125	250	300
B400	420	130	225	247	263	271	352	208	125	150	350	400
B500	520	156	290	306	328	367	416	312	150 ❶	200 ❶	400 ❶	450 ❶
B630	630	198	335	368	368	368	440	368	200 ❶	250 ❶	500 ❶	500 ❶

❶ No UL/CSA ratings; data given for indication and reference purposes only.

UL/CSA DUTY FOR AC MOTOR SWITCHING

Three-phase AC induction motors; breaking at rated motor current.
UL/CSA RATINGS at ambient temperature $\leq 55^{\circ}\text{C}$

ELECTRICAL IEC LIFE FOR MOTOR CONTROL AC3 $\leq 440\text{V}$

Electrical life of contactors

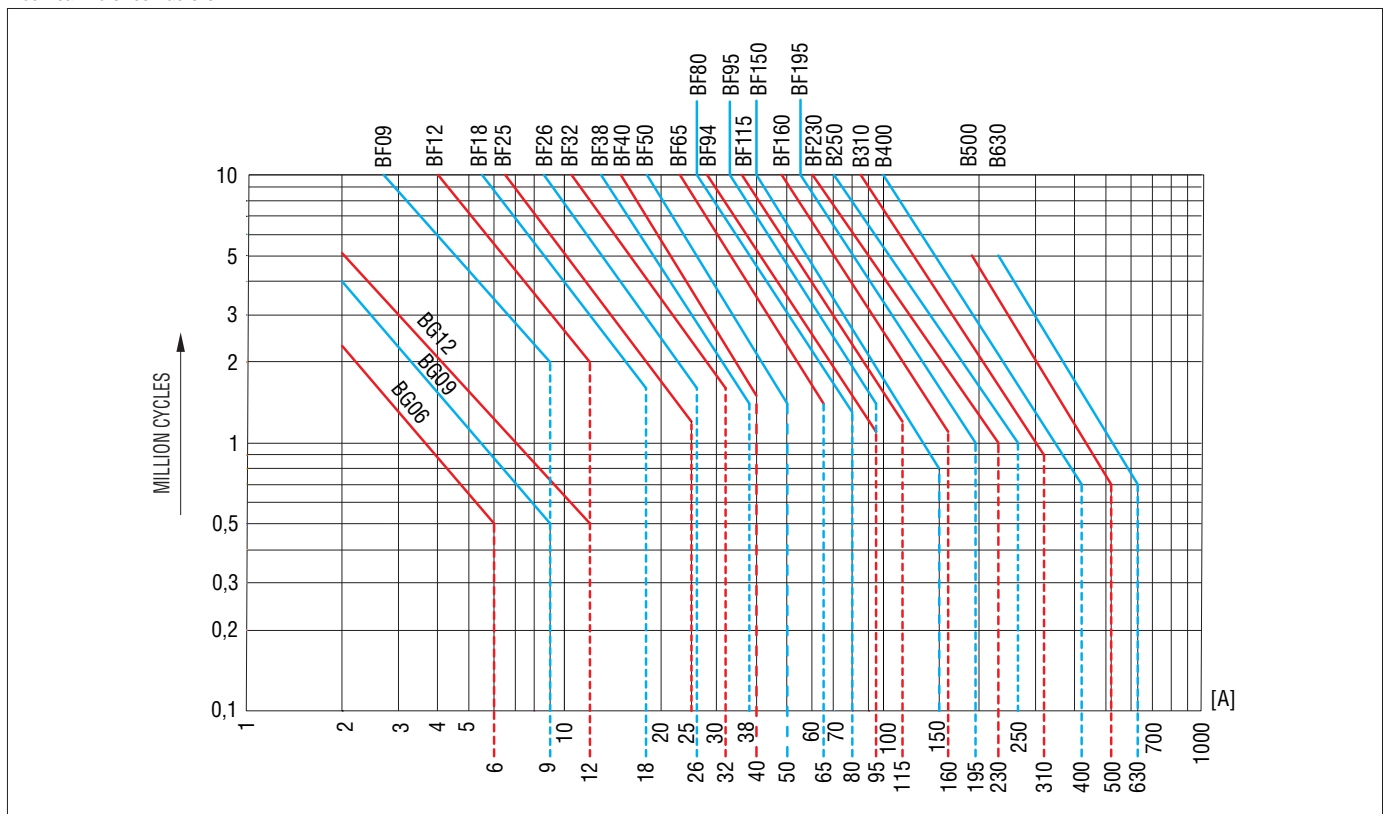

IEC DC UTILISATION CATEGORY
POLE CHARACTERISTICS

MAXIMUM OPERATIONAL CURRENT

IEC Voltage U _e	Contactor Type	IEC Maximum current I _e [A] in categories: DC1 with L/R ≤ 1ms and poles in series				DC3 - DC5 with L/R ≤ 15ms and poles in series			
		1	2	3	4	1	2	3	4
≤ 24V	BG06	9	12	14	–	6	7	9	–
	BG09	12	15	16	16	7	8	10	10
	BG12	12	15	16	–	7	8	10	–
	BF09	15	18	20	20	10	13	15	15
	BF12	17	20	22	20	12	15	18	15
	BF18	17	20	22	22	12	15	18	18
	BF25	20	23	23	–	15	18	22	–
	BF26	25	28	28	28	18	20	25	30
	BF32	30	32	32	–	20	25	30	–
	BF38	35	36	36	36	24	28	32	32
	BF40	40	48	48	–	27	32	40	–
	BF50	45	60	60	60	30	35	50	55
	BF65	50	70	70	70	35	45	55	60
	BF80	70	100	100	100	40	60	80	90
	BF94	77	110	110	115	45	65	86	96
	BF95	140	140	140	140	140	140	140	140
BF115	160	160	160	160	160	160	160	160	
BF150	165	165	165	165	165	165	165	165	
48V	BG06	8	11	14	–	5	7	9	–
	BG09	10	14	16	16	6	8	10	10
	BG12	10	14	16	–	6	8	10	–
	BF09	13	18	20	20	9	11	15	15
	BF12	15	20	22	20	11	13	18	15
	BF18	15	20	22	22	11	13	18	18
	BF25	18	23	23	–	13	18	22	–
	BF26	21	28	28	28	15	20	25	30
	BF32	26	32	32	–	17	22	28	–
	BF38	30	34	34	34	20	25	28	28
	BF40	35	48	48	–	23	30	40	–
	BF50	40	60	60	60	25	35	50	55
	BF65	50	70	70	70	25	40	50	60
	BF80	60	100	100	100	30	50	70	90
	BF94	66	110	110	115	33	55	75	95
	BF95	140	140	140	140	44	63	115	110
BF115	160	160	160	160	50	72	150	120	
BF150	165	165	165	165	60	82	195	130	
75V	BG06	4	7	8	–	2	4	5	–
	BG09	4	9	10	10	2	5	6	6
	BG12	4	9	10	–	2	5	6	–
	BF09	12	17	20	20	8	10	13	15
	BF12	13	18	20	20	10	12	15	15
	BF18	15	20	20	20	11	13	16	16
	BF25	18	23	23	–	13	16	18	–
	BF26	18	25	25	25	13	18	20	25
	BF32	22	28	32	–	15	20	28	–
	BF38	23	29	33	33	17	22	28	28
	BF40	30	45	48	–	19	27	38	–
	BF50	40	60	60	60	22	30	45	55
	BF65	50	70	70	70	25	40	50	60
	BF80	60	100	100	100	30	50	70	90
	BF94	66	110	110	115	33	55	75	95
	BF95	100	140	155	155	36	60	90	110
BF115	120	160	160	160	40	65	100	120	
BF150	150	165	165	165	44	70	110	130	

POLE CHARACTERISTICS

MAXIMUM OPERATIONAL CURRENT

IEC Voltage U _e	Contactor Type	IEC Maximum current I _e [A] in categories: DC1 with L/R ≤ 1ms and poles in series				DC3 - DC5 with L/R ≤ 15ms and poles in series			
		1	2	3	4	1	2	3	4
110V	BG06	3	6	8	–	1	3	4	–
	BG09	3	8	10	10	1	4	5	5
	BG12	3	8	10	–	1	4	5	–
	BF09	6	12	15	16	2	7	11	12
	BF12	6	13	16	16	2	8	12	16
	BF18	6	13	16	18	2	8	12	13
	BF25	6	16	18	–	2	10	15	–
	BF26	6	22	24	24	2	13	18	20
	BF32	8	25	27	–	2,5	15	20	–
	BF38	8	32	34	34	2,5	18	23	23
	BF40	8	42	44	–	3	22	27	–
	BF50	8	50	55	60	3	25	30	45
	BF65	8	60	60	70	3	30	35	50
	BF80	8	80	85	100	3	40	60	75
	BF94	8	90	93	110	3	43	64	80
	BF95	10	110	120	140	6	55	85	105
	BF115	10	130	140	160	6	65	100	125
BF150	10	150	160	165	6	80	120	150	
220V	BG06	–	–	1	–	–	–	0,5	–
	BG09	–	–	2	2	–	–	0,8	0,8
	BG12	–	–	2	–	–	–	0,8	–
	BF09	–	1	10	12	–	2	6	7
	BF12	–	1	11	12	–	2	6	7
	BF18	–	1	11	13	–	2	6	8
	BF25	–	1	12	–	–	2	8	–
	BF26	–	2	20	26	–	3	19	15
	BF32	–	3	23	–	–	3	23	–
	BF38	–	4	30	38	–	3	25	15
	BF40	–	5	56	70	–	5	32	40
	BF50	–	7	75	90	–	5	40	50
	BF65	–	9	90	110	–	5	52	65
	BF80	–	9	95	115	–	5	64	80
	BF94	–	9	95	115	–	5	64	80
	BF95	–	12	125	140	–	7	76	95
	BF115	–	14	145	160	–	7	92	115
BF150	–	14	150	165	–	7	120	150	

IEC DC UTILISATION CATEGORY
POLE CHARACTERISTICS
MAXIMUM OPERATIONAL CURRENT

IEC Voltage U _e	Contactor Type	IEC Maximum current I _e [A] in categories: DC1 with L/R ≤ 1ms and poles in series				DC3 - DC5 with L/R ≤ 15ms and poles in series			
		1	2	3	4	1	2	3	4
75V	BF160	250	250	250	250	160	160	160	160
	BF195	275	275	275	275	180	180	180	180
	BF230	350	350	350	350	250	250	250	250
	B250	350	350	350	350	280	280	280	280
	B310	375	375	375	375	310	310	310	310
	B400	400	400	400	400	350	350	350	350
	B500	650	650	650	650	550	550	550	550
	B630	800	800	800	800	800	800	800	800
110V	BF160	110	150	160	250	80	120	140	140
	BF195	120	170	170	275	90	140	160	160
	BF230	145	270	270	350	135	225	250	250
	B250	160	300	300	300	150	250	280	280
	B310	195	350	350	350	170	290	310	310
	B400	250	400	400	400	200	350	350	350
	B500	320	550	600	600	320	550	550	550
	B630	460	800	800	800	460	800	800	800
220V	BF160	-	130	150	250	-	90	120	140
	BF195	-	150	170	275	-	100	140	160
	BF230	-	225	270	350	-	180	225	225
	B250	-	250	300	300	-	200	250	280
	B310	-	300	350	350	-	230	290	310
	B400	-	350	400	400	-	280	350	350
	B500	-	450	600	600	-	450	550	550
	B630	-	700	800	800	-	700	800	800
330V	BF160	-	-	130	150	-	-	90	140
	BF195	-	-	150	170	-	-	100	160
	BF230	-	-	225	270	-	-	180	210
	B250	-	-	250	300	-	-	200	280
	B310	-	-	300	350	-	-	230	310
	B400	-	-	350	400	-	-	280	350
	B500	-	-	450	600	-	-	450	550
	B630	-	-	700	750	-	-	650	700
460V	BF160	-	-	-	130	-	-	-	90
	BF195	-	-	-	150	-	-	-	100
	BF230	-	-	-	225	-	-	-	180
	B250	-	-	-	250	-	-	-	200
	B310	-	-	-	300	-	-	-	230
	B400	-	-	-	350	-	-	-	280
	B500	-	-	-	450	-	-	-	450
	B630	-	-	-	700	-	-	-	700

IEC UTILISATION CATEGORIES DC1, DC3 AND DC5.

POLE CHARACTERISTICS

CHOICE CRITERIA

The elements to be considered for the contactor choice are:

- Rated operational current Ie
- Rated operational voltage Ue
- Utilisation category and L/R time constant
- Eventual verification of electrical life.

OPERATING CONDITIONS

Indicated current is valid for:

- Ambient temperature $\leq 55^{\circ}\text{C}$
- Operating cycles: up to 120 cy/h with 60% on-load factor
up to 250 cy/h with 30% on-load factor.

POLES IN SERIES

It is important to use contactors with the indicated number of poles in series depending on operating voltage.

The poles in series can be connected to one single polarity or divided between the two polarities of the circuit indifferently.

NOTE. For voltages lower than 30V, the diagrams given in figures 3 and 4 are not recommendable since voltage drops can take place. In these cases, it is better to use poles in parallel considering the notes given in the following section.

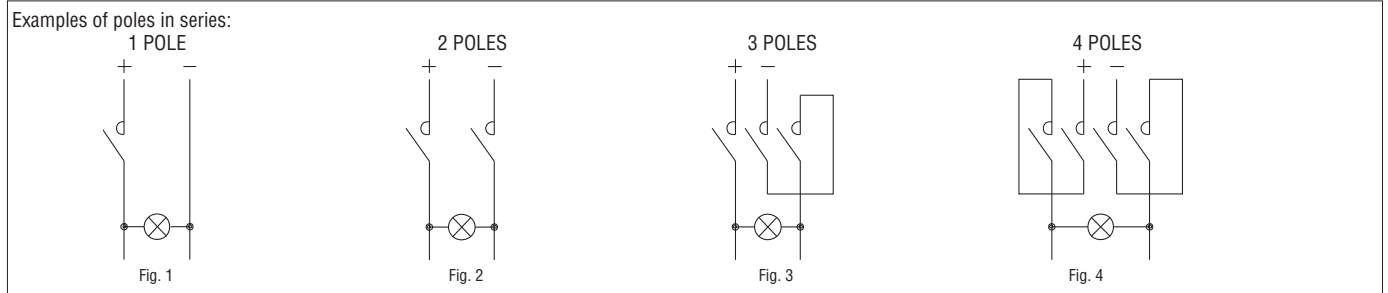

POLES IN PARALLEL

It is possible to increase the electrical life by placing poles in series when using voltages which require 1 or 2 poles in parallel.

Poles in parallel do not increase the maximum operational current given in the previous pages; that is, if one pole has a maximum operational current in DC5 of 8A, two poles in parallel, it will always be 8A.

With poles in parallel, it is possible to increase the rated contact capacity (Ith) only if the contactor opens and closes in no-load conditions or when used as resistance shunts.

In this case, the contact capacity can be increased.

The value can be obtained by multiplying the rated current of one pole by the K factor given below; e.g.: if one pole carries 10A, three poles in parallel can carry $10 \times 2.2 = 22\text{A}$.

Therefore, the operating current is the one indicated in the tables, multiplied by the K factor given below which takes into consideration the unequal current division on the various poles.

- 2 POLES in parallel K = 1.6
- 3 POLES in parallel K = 2.2
- 4 POLES in parallel K = 2.8

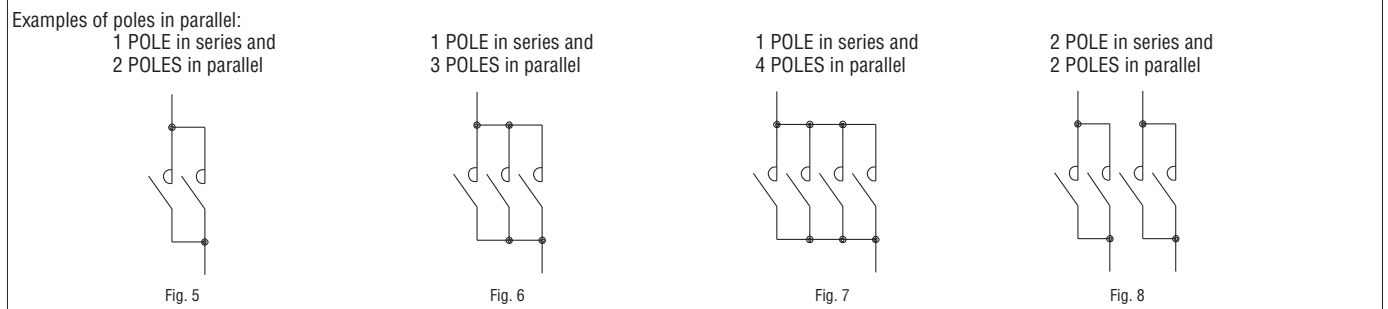

MAXIMUM OPERATIONAL CURRENT

See tables on pages 2-57 to 2-59.

OTHER CONDITIONS

For different operating conditions or voltage not included among those indicated in the tables, on pages 2-57 to 2-59, consult Technical support (Tel. 035 4282422; E-mail: service@LovatoElectric.com).

IEC SELECTION GUIDE FOR LIGHTING CIRCUIT SWITCHING

GENERAL INFORMATION

The elements which are to be considered for the contactor choice are:

- Type of lamp
- Power factor (cosφ)
- With or without power factor correction
- Value of current when switching on and in running conditions.

Depending on the number and type of lamps, it is also important to bear in mind the main discriminating characteristics given below for the contactor choice:

- Incandescent lamps → contactor making capacity
- Lamps not corrected → rated contactor current in AC1
- Lamps corrected → rated contactor current in AC3

The table below summarises the major characteristics depending on the more commonly used type of lamps:

Type of lamps	Switching on		Switching off	
	Multiple of In ^①	cosφ	Multiple of In ^①	cosφ
Incandescent	15	1	1	1
Mixed light	1.3	1	1	1
Fluorescent	1.15 - 1.3	0.2	1	0.3 - 0.5 (not corrected) 1 (corrected)
High-pressure mercury vapour	1.5 - 1.75	0.2	1	0.45 - 0.7 (not corrected)
High-pressure sodium vapour	1.3 - 1.5	0.2	1	0.3 - 0.5 (not corrected)
Low-pressure sodium vapour	1	0.2 - 0.5	1	0.2 - 0.5 (not corrected)
Metal halide	1.7 - 2.1	0.2	1	0.4 - 0.5 (not corrected)
LED	20...40 ^②	0.6...0.95	1	0.6...0.95

Lamp features	Lamp power [W]	Rated current [A]	Capacitor capacity [μF]	Maximum number [n] of lamps for each contactor pole ^②													
				BG06	BF09	BF12	BF25	BF26	BF32	BF38	BF40	BF50	BF65	BF80	BF94	BF95	BF115
LED 220...240V 50/60Hz	See note ③			Each pole can carry 67% of the rated current AC3 ^④													
INCANDESCENT 220...240V	50/60Hz	60	0.27	-	30	48	92	118	129	203	240	296	370	425	462		
		100	0.45	-	18	28	55	71	77	122	144	177	222	255	277		
		200	0.91	-	8	14	27	35	38	60	71	87	109	126	137		
		300	1.4	-	5	9	17	22	25	39	46	57	71	82	89		
		500	2.3	-	3	5	10	13	15	23	28	34	43	50	54		
	1000	4.6	-	1	2	5	6	7	11	14	17	21	25	27			
MIXED LIGHT 220...240V	50/60Hz	100	0.45	-	20	33	57	77	88	122	144	177	244	311	377		
		160	0.72	-	12	20	36	48	55	76	90	111	152	194	236		
		250	1.13	-	8	13	23	30	35	48	57	70	97	123	150		
		500	2.3	-	4	6	11	15	17	23	28	34	47	60	73		
		1000	4.6	-	1	3	5	7	8	11	14	17	23	30	36		
ELECTRONIC BALLAST FLUORESCENT 220...240V 50/60Hz (EVG)	Single mounting	16 / 18	0.1	(6.8) ^⑤	48	80	160	220	220	400	450	500	750	1050	1200		
		32 / 36	0.18	(6.8) ^⑤	27	44	88	122	122	222	250	277	416	583	666		
	Dual mounting	50 / 58	0.27	(10) ^⑤	17	29	59	82	82	148	166	185	277	388	444		
		2x16 / 18	0.18	(10) ^⑤	26	44	88	122	122	222	250	277	416	583	666		
		2x32 / 36	0.35	(10) ^⑤	13	22	45	62	62	114	128	142	214	300	342		
	2x50 / 58	0.52	(22) ^⑤	9	15	30	42	42	76	86	96	144	201	230			
STANDARD FLUORESCENT 220...240V 50/60Hz	Not corrected Single mounting	15	0.35	-	25	42	74	100	114	157	185	228	314	400	485		
		20	0.37	-	24	40	70	94	108	148	175	216	297	378	459		
		40	0.44	-	20	34	59	79	90	125	147	181	250	318	386		
		65	0.7	-	12	21	37	50	57	78	92	114	157	200	242		
		115	1.5	-	6	10	17	23	26	36	43	53	73	93	113		
		140	1.5	-	6	10	17	23	26	36	43	53	73	93	113		
	Corrected Single mounting	15	0.11	4.5	24	40	62	94	94	200	200	200	533	533	533		
		20	0.16	4.5	24	40	62	94	94	200	200	200	533	533	533		
		40	0.24	4.5	24	40	62	94	94	200	200	200	458	500	520		
		65	0.4	7	15	25	40	50	57	125	128	128	275	300	312		
		115	0.7	18	6	10	15	23	23	50	50	50	133	133	133		
		140	0.7	18	6	10	15	23	23	50	50	50	133	133	133		
	DUO circuit	2 x 20	0.26 ^④	-	54	57	100	153	153	211	250	307	423	538	653		
		2 x 40	0.46 ^④	-	19	32	56	86	86	119	141	173	239	304	369		
		2 x 65	0.7 ^④	-	12	21	37	57	57	78	92	114	157	200	242		
2 x 115		1.3 ^④	-	6	11	20	30	30	42	50	61	84	107	130			
2 x 140		1.5 ^④	-	6	10	17	26	26	36	43	53	73	93	113			

① In = Rated lamp current.

② For 220/240V circuits, either single-phase (between phase and neutral) or 2-wire (between phase and phase), the maximum number of lamps is as per the table.

③ For three-phase circuits with neutral 380/415V or 220/240V, the maximum number of lamps controlled by the same contactor is n * 3.

④ For three-phase 380/415V circuits without neutral, the maximum number of lamps controlled by the same contactor is n * √3.

⑤ Electrical life is 100,000 cycles up to 55°C.

⑥ Incorporated capacitor.

⑦ Total.

⑧ With reference to the AC side of the power supplies.

⑨ Usually, each light has its own power supply. If a power supply controls several lights, the number of power supplies must be factored into the calculation. The sum of the rated currents of the power supplies connected to each pole of the contact must not exceed 67% of the rated current AC-3 of the contactor indicated on page 2-6.

e.g. BF18 has a rated current AC-3 of 18A; it can control 18x0.67=12.06A per pole at most.

Lamp features		Lamp power [W]	Rated current [A]	Capacitor capacity [µF]	Maximum number [n] of lamps for each contactor pole ^①												
					BG06	BF09	BF26			BF40		BF65		BF115		BF195	
					BG09	BF12	BF18	BF25	BF32	BF38	BF50	BF94	BF95	BF150	BF160	BF230	
HIGH-PRESSURE MERCURY VAPOUR 220/240V 50/60Hz	Not corrected	50	0.61	-	10	16	26	36	44	65	73	82	122	172	196		
		80	0.8	-	7	12	20	27	33	50	56	62	93	131	150		
		125	1.2	-	5	8	13	18	22	33	37	41	62	87	100		
		250	2.2	-	3	4	7	10	12	18	20	22	34	47	54		
		400	3.4	-	2	3	5	6	7	11	13	14	22	30	35		
		700	5.5	-		1	3	4	4	7	8	9	13	19	21		
		1000	8	-		1	2	2	3	5	5	6	9	13	15		
	Corrected	50	0.29	7	15	25	40	60	60	128	128	128	258	342	342		
		80	0.42	8	13	22	35	52	53	95	107	112	178	250	285		
		125	0.7	10	8	14	22	31	35	57	64	71	107	150	171		
		250	1.3	18	4	7	12	16	19	30	34	38	57	80	92		
		400	2.1	25	2	4	7	10	11	19	21	23	35	50	57		
		700	3.6	40	-	2	4	6	6	11	12	13	20	29	33		
		1000	5.3	60	-	1	3	4	4	7	8	9	14	19	22		
380/415V 50/60Hz	Not corrected	2000	8	-	-	-	1	2	2	3	3	4	5	8	9		
	Corrected	2000	5.5	35	-	-	1	2	2	4	5	5	8	11	13		
HIGH-PRESSURE SODIUM VAPOUR 220/240V 50/60Hz	Not corrected	150	1.8	-	3	5	8	12	15	22	25	27	41	58	66		
		250	3	-	2	3	5	7	9	13	15	16	25	35	40		
		400	4.7	-	1	2	3	4	5	8	9	10	15	22	25		
		600	7.1	-	-	1	2	3	3	5	6	6	10	15	16		
		1000	10.4	-	-	-	1	2	2	3	4	4	7	10	11		
	Corrected	150	0.83	20	-	9	14	19	21	45	45	45	90	120	120		
		250	1.5	36	-	5	7	10	11	25	25	25	50	66	66		
		400	2.4	48	-	3	5	6	7	16	18	18	31	43	50		
		600	3.5	68	-	2	3	4	4	10	12	12	20	28	34		
		1000	6.3	120	-	1	1	2	2	6	7	7	11	16	19		
LOW-PRESSURE SODIUM VAPOUR 220/240V 50/60Hz	Not corrected	35	1.5	-	4	6	10	14	18	26	30	33	50	70	80		
		55	1.5	-	4	6	10	14	18	26	30	33	50	70	80		
		90	2.4	-	3	4	6	9	11	16	18	20	31	43	50		
		135	3.1	-	2	3	5	7	8	12	14	16	24	33	38		
		150	3.2	-	2	3	5	6	8	12	14	15	23	32	37		
		180	3.3	-	2	3	4	6	8	12	13	15	22	31	36		
		2000	5.3	60	-	1	3	4	4	7	8	9	14	19	22		
	Corrected	35	0.31	20	-	6	10	14	18	45	45	45	120	120	120		
		55	0.42	20	-	6	10	14	18	45	45	45	120	120	120		
		90	0.63	30	-	4	6	9	11	30	30	30	80	80	80		
		135	0.94	40	-	3	5	7	8	22	22	22	60	60	60		
		150	1	40	-	3	5	6	8	22	22	22	60	60	60		
		180	1.2	40	-	3	4	6	8	22	22	22	60	60	60		
METAL HALIDE 220/240V 50/60Hz	Not corrected	35	0.3	-	-	28	50	66	80	100	150	167	250	330	400		
		70	0.5	-	-	16	28	40	50	60	90	100	150	200	240		
		150	1	-	-	8	14	20	25	30	45	50	75	100	120		
		250	3	-	-	3	5	7	9	13	15	16	25	35	40		
		400	3.5	-	-	2	4	6	7	11	12	14	21	30	34		
		1000	10	-	-	1	1	2	2	4	4	5	7	10	12		
		2000	17	-	-	-	-	1	1	2	2	2	4	6	7		
		2000	17	-	-	-	-	1	1	2	2	2	4	6	7		
	Corrected	35	0.17	6	-	33	60	65	65	200	240	260	400	420	440		
		70	0.28	12	-	20	36	40	40	120	145	155	240	255	265		
		150	0.6	20	-	9	17	18	18	56	68	74	112	118	120		
		250	1.5	32	-	5	7	8	10	26	28	28	46	50	53		
		400	2	35	-	4	5	6	7	20	22	25	35	37	40		
		1000	5.8	95	-	1	1	2	2	6	7	8	12	12	13		
		2000	11.5	148	-	-	-	1	1	3	3	4	6	6	6		
		2000	11.5	148	-	-	-	1	1	3	3	4	6	6	6		
380/415V 50/60Hz	Not corrected	2000	10.3	-	-	-	-	1	1	2	2	3	4	6	7		
		3500	18	-	-	-	-	-	-	1	1	1	2	3	4		
	Corrected	2000	6.6	60	-	-	1	1	1	3	3	4	6	7	7		
		3500	11.6	100	-	-	-	-	-	2	2	2	3	3	4		

① For 220/240V circuits, either single-phase (between phase and neutral) or 2-wire (between phase and phase), the maximum number of lamps is as per the table.
 For three-phase circuits with neutral 380/415V or 220/240V, the maximum number of lamps controlled by the same contactor is $n \cdot 3$.
 For three-phase 380/415V circuits without neutral, the maximum number of lamps controlled by the same contactor is $n \cdot \sqrt{3}$.
 Electrical life is 100,000 cycles up to 55°C.

POWER FACTOR CORRECTION CAPACITORS

CHOICE CRITERIA

The contactor during the closing transition is influenced by electrical currents having high frequencies and high amplitudes. The frequencies of these currents range between 1 and 10kHz; the amplitudes must have values lower than the maximum permissible current peak of the contactor to be used.

AMBIENT OPERATING CONDITIONS

Ambient temperature: $\leq 50^\circ\text{C}$.
 For temperatures higher than 50°C up to 70°C , stated maximum operational power ratings are to be reduced by a percentage equal to the difference between the ambient temperature and 50°C .
 Operating cycle: ≤ 120 cy/h
 Electrical life: $\geq 100,000$ cycles.

Contactor	IEC rated current $\leq 400\text{V}$	Maximum permissible peak current	IEC maximum operational voltage	Fuse gG	IEC maximum operational power (AC-6b)			
					220V 230V 240V	380V 400V	415V 440V	500V 660/690V
Type	[A]	[A]	[V]	[A]	[kvar]	[kvar]	[kvar]	[kvar]
BF09A	12	500	690	16	4.5	7.5	9	10
BF12A	18	550	690	25	7	12.5	12	14
BF18A	23	1000	690	32	9	15	16	18
BF25A	23	1000	690	32	9	15	16	18
BF26A	30	1400	690	40	11	20	22	22
BF32A	36	1700	690	50	14	25	27	30
BF38A	43	1900	690	63	17	30	30	34
BF40A	50	2500	1000	100	20	35	40	45
BF50A	58	2500	1000	80	22	40	41	45
BF65A	65	2500	1000	100	26	45	50	52
BF80A	75	2500	1000	125	30	50	56	70
BF94A	75	2500	1000	125	30	50	56	70
BF95A	90	3000	1000	125	34	60	75	80
BF115A	115	3000	1000	160	45	75	85	135
BF150A	144	3000	1000	160	50	100	115	150
BF160	150	3400	1000	200	57	100	108	130
BF195	170	3600	1000	250	65	112	122	150
BF230	215	4500	1000	315	85	140	150	190
B250	240	5100	1000	315	91	158	172	210
B310	265	5900	1000	315	105	184	200	245
B400	320	7500	1000	400	122	211	230	280
B500	500	9000	1000	630	190	330	360	430
B630	610	11000	1000	800	230	400	432	520

The use of contactors with the above operational powers is allowable only when the peak current, in the installation point of the power factor correction board, is lower than the values stated in the table. If this condition is not verified, it is necessary to use limiting inductances or specific contactors stated on page 2-16. Consult Technical support (see contact details on inside front cover) to obtain detailed information on the correct use of contactors without limiting inductances.

LIMITING INDUCTANCES

The use of limiting inductances is imperative when the system inductances (line transformer and cables), upstream of the power factor correction panel, are not able to maintain the maximum connecting current within the limit value of the contactor used.

FAST DISCHARGE RESISTANCES OF CAPACITORS

The use of the contactor, according to the wiring diagram given, allows the fast discharge of the capacitors as well as the instantaneous disconnection of the capacitors from the mains when the coil is de-energised. The resistances, indicated in the following table, guarantee the discharge within a maximum time of 2 seconds.

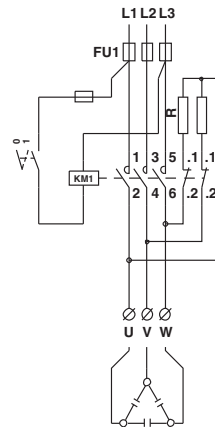

Capacitor power [kvar]	Voltage 220...230V		Voltage 380...500V	
	[Ω]	[W]	[Ω]	[W]
2.5-5	3900	12	8200	12
10-15	1800	25	4300	25
20-50	1000	50	2200	50

SPECIAL CONTACTORS FOR POWER FACTOR CORRECTION CAPACITORS

GENERAL CHARACTERISTICS

These contactors are equipped with early-make contacts. This special type of contact has the purpose of connecting for a very brief interval, 2-3ms, during the contactor closing, resistors which limit the connecting current of the capacitors. These resistors are then excluded when the closing operation is complete and the current capacity is conveyed to the main contacts. With this type of circuit, it is possible to obtain minor wear of all the components of the system especially fuses and capacitors ensuring a longer life and better reliability. The contactors are particularly suitable for use in automatic power factor correction panels since there is no need of limiting inductances and a source of heat has been eliminated. In this way, these modular electric switchboards can be more compact.

The BFK version, figure 1, is designed for three-phase switching. The peculiarity of this type is in the contacts, suitable to connect limiting resistors, which close only for the time needed to limit any in-rush current peak and then reopen to avoid eventual flow of residual currents through the resistors.

AMBIENT OPERATING CONDITIONS

Ambient temperature: $\leq 50^\circ\text{C}$

For ambient temperature higher than 50°C up to 70°C , maximum operational power ratings, indicated in the table, are to be reduced by a percentage equal to the difference between the ambient temperature and 50°C .

Operating cycles: ≤ 120 cy/h.

Electrical life: $\geq 400,000$ cycles.

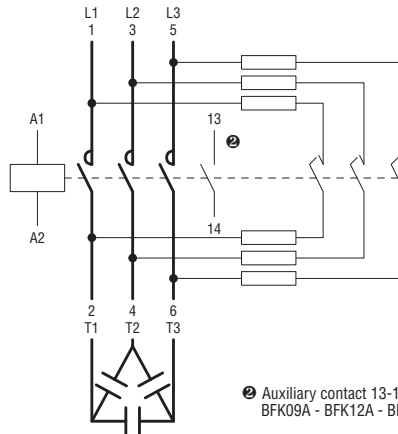

Fig. 1

Contactor	Built-in auxiliary contacts NO	IEC rated operational current $\leq 440\text{V}$	IEC fuse gG	Maximum IEC power at $\leq 50^\circ\text{C}$ (AC6b) ①			
				220V 230V 240V	380V 400V	415V 440V	500V 690V
Type	n°	[A]	[A]	[kvar]	[kvar]	[kvar]	[kvar]
BFK09A	1	12	16	4.5	7.5	9	10
BFK12A	1	18	25	7	12.5	14	16
BFK18A	1	23	40	9	15	17	20
BFK26A	—	30	40	11	20	22	25
BFK32A	—	36	63	14	25	27.5	30
BFK38A	—	43	63	17	30	33	36
BFK50A	—	58	80	22	40	41	46
BFK65A	—	65	100	26	45	50	56
BFK80A	—	75	125	30	50	56	65
BFK94A ②	—	90	125	34	60	75	80
BFK95A	—	90	125	34	60	75	80
BFK115A	—	115	160	45	75	85	135
BFK150A	—	144	160	50	100	115	150

NOTE: See page 2-16 for order codes.

① Consult Technical support (Tel. 035 4282422; E-mail: service@LovatoElectric.com) for the use of contactors to switch within delta connection.

② Note: The maximum thermal current of the BFK94 contactor is 115A.

CHOICE OF CONTACTORS TYPE BFK ACCORDING TO cULus LISTING

Contactor	Built-in auxiliary contacts NO (SPST)	UL/CSA rated current $\leq 440\text{V}$	UL/CSA protection fuse SC/gG	Maximum UL/CSA operational power at voltage:		
				240V	480V	600V
Type	n°	[A]	[A]	[kvar]	[kvar]	[kvar]
BFK09A	1	12	16	4.5	9	10
BFK12A	1	18	25	7	14	16
BFK18A	1	23	40	9	17	20
BFK26A	—	30	40	11	22	27.5
BFK32A	—	36	63	14	27.5	32
BFK38A	—	43	63	17	33	36
BFK50A	—	58	80	22	41	46
BFK65A	—	70	100	26	50	56
BFK80A	—	75	125	30	60	75
BFK95A	—	100	125	40	80	100
BFK115A	—	115	160	45	90	120
BFK150A	—	121	160	50	100	125

NOTE: See page 2-16 for order codes.

IEC OPERATIONAL CHARACTERISTICS BG00 AND BF00

TYPE		BG00	BF00A	BF00D	BF00L
POLE CONTACT CHARACTERISTICS					
Poles ^①	n°	4			
Conventional free air thermal current I _{th} (≤40°C)	A	10			
Rated insulation voltage U _i	V	690			
Frequency limit	Hz	25...400 ^②			
UL/CSA and IEC/EN/BS 60947-5-1 auxiliary contact designation	AC	A600			
	DC	Q600		P600	
Terminals	A	7.5		8.3	
	B	4		3.5	
	Screw	M3		M3.5	
	Phillips	2		2	
	Faston	1x6.35 - 2x2.8		—	
Tightening torque for contact terminals min-max	Nm	9		13...16	
	lb.in	0.59-0...74		1.03...1.33	
Tightening torque for coil terminals min-max	Nm	0.8...1			
	lb.in	7...9			
	Phillips	2			
Conductor section connectable with 1 or 2 wires min ... max	AWG stranded	n°	18...12		16...10
	Flexible w/o lug	mm ²	0.75...2.5		1...6
	Flexible c/w boot-lace ferrule	mm ²	2x1.5 or 1x2.5		1...4
	Flexible c/w spade lug	mm ²	2x1.5 or 1x2.5		1...4
Terminal protection according to IEC/EN/BS 60529		IP20 ^③			
AMBIENT CONDITIONS					
Operating temperature	°C	-50...+70			
Storage temperature	°C	-60...+80			
Maximum altitude	m	3000			
Operation position	Normal	On vertical plane			
	Allowable	±30°			
Fixing		Screw or on 35mm DIN rail			



Quick-connect

① The built-in auxiliary contacts are high-conductivity
 ② Derating for use at 61-400 Hz. Consult Technical support for information (Tel. 035 4282422; E-mail: service@LovatoElectric.com).
 ③ IP20 protection warranted by wired equipment; minimum 0.75mm² conductor section for BG00 or 1mm² for BF00.

ELECTRICAL RATINGS BASED ON IEC/EN/BS 60947-5-1 UTILIZATION CATEGORIES AND UL508/CSA C22.2 n°14

IEC/EN/BS designation	IEC/EN/BS utilization category	Conventional enclosed thermal current I _{the}	Rated operational current I _e [A] at rated operational voltage U _e										VA rating	
UL designation	—	Thermal continuous test current	Maximum Amperes (AC) 60Hz										Maximum VA	
Alternating current		[A]	120VAC		240VAC		380VAC		480VAC		600VAC		Make	Break
A600	AC-15	10	60	6	30	3	19	1.9	15	1.5	12	1.2	7200	720
Direct current			Maximum Amperes (DC) Make or Break											
			125VDC		250VDC		301VDC		400VDC		500VDC		600VDC	
P600	DC-13	5	1.1	0.55	0.2	④	0.31	④	0.27	④	0.2	138	138	
Q600	DC-13	2.5	0.55	0.27	0.1	④	0.15	④	0.13	④	0.1	69	69	

④ Value at 301V is valid for UL/CSA up to 600VDC; the others are valid for IEC/EN/BS.
 ⑤ Voltage valid for UL/CSA only.

TYPE				BG00	BF00A	BF00D	BF00L
AC CONTROL							
Rated control voltage at 50/60Hz or 60Hz		V		12...575	12...600	—	—
Operating voltage limits							
50/60Hz coil powered at	50Hz	pick-up	% Us	75...115	80...110	—	—
		drop-out	% Us	20...55	20...55	—	—
	60Hz	pick-up	% Us	80...115	80...110	—	—
		drop-out	% Us	20...55	20...55	—	—
60Hz coil powered at	60Hz	pick-up	% Us	75...115	80...110	—	—
		drop-out	% Us	20...55	20...55	—	—
Average coil consumption at ≤20°C							
50/60Hz coil powered at	50Hz	in-rush	VA	30	75	—	—
		holding	VA	4	9	—	—
	60Hz	in-rush	VA	25	70	—	—
		holding	VA	3	6.5	—	—
60Hz coil powered at	60Hz	in-rush	VA	30	75	—	—
		holding	VA	4	9	—	—
Dissipation at holding ≤20°C		50Hz	W	0.95	2.5	—	—
DC CONTROL							
Rated control voltage		V		6...250	—	6...415	6...415
Operating voltage limits		pick-up	% Us	75...115	—	70...125	80...110
		drop-out	% Us	10...20	—	10...40	10...40
Average consumption at ≤20°C (in-rush/holding)		W		3.2①	—	5.4	2.4
OPERATING TIMES							
Average time for Us control in	AC	closing NO	ms	12...21	8...24	—	—
		opening NO	ms	9...18	10...20	—	—
		closing NC	ms	17...26	17...30	—	—
		opening NC	ms	7...17	7...18	—	—
	DC	closing NO	ms	18...25	—	54...66	75...91
		opening NO	ms	2...3	—	14...17	15...19
		closing NC	ms	3...5	—	24...30②	24...30③
		opening NC	ms	11...17	—	47...57②	67...81③
LIFE							
Mechanical	AC control	cycles		20 million			
	DC control	cycles		20 million			
MAXIMUM OPERATING RATE							
Mechanical operations			cycles/h	3600			

① 2.3W for low-consumption BG00...L version.
 ② NC closing time for BF0004D is 23...29ms while NC opening time is 40...49ms.
 ③ NC closing time for BF0004L is 25...31ms while NC opening time is 56...68ms.

IEC OPERATIONAL CHARACTERISTICS BG06..., BG09... AND BG12...

TYPE		BG06	BG09	BG12
POLE CHARACTERISTICS				
Power poles	n°	3	3-4	3
Rated insulation voltage Ui	V	690	690 ❶	690
Rated impulse withstand voltage Uimp	kV	6	6	6
Operational frequency	Hz	25...400 ❷	25...400 ❷	25...400 ❷
Operational current	Conventional free air thermal Ith (≤40°C)	A	16	20
	AC3 (≤440V ≤55°C)	A	6	9
	AC4 (400V) ❸	A	3.3	4.0
Short-time allowable current for 10s (IEC/EN/BS 60947-1)	A	96	96	96
Maximum fuse size coordination Type 2 - 400V - 50kA	gG	A	16	20
	aM	A	6	10
Making capacity (RMS value)	A	92	92	120
Breaking capacity at voltage	≤ 440V	A	72	72
	500V	A	72	72
	690V	A	72	72
Consumption per pole and resistance (average values)		mΩ	10	10
	Ith	W	2.6	4
	AC3	W	0.36	0.81
Terminals		A [mm]	7.5	7.5
		B [mm]	4	4
		screw	M3	M3
		Phillips	2	2
	Quick-connect	Faston	—	1x6.35 - 2x2.8
	Solder		—	PIN for PCB❹
Tightening torque for pole and coil terminals min-max	Nm	0.8...1	0.8...1	0.8...1
	lb.in	9	9	9
	Phillips	2	2	2
Conductor section connectable with 1 or 2 wires min...max	AWG stranded	N°	18...12	
	Flexible w/o lug	mm²	0.75...2.5	
	Flexible c/w boot-lace ferrule	mm²	2x1.5 or 1x2.5	
	Flexible c/w spade lug	mm²	2x1.5 or 1x2.5	
Terminal protection to IEC/EN/BS 60529			IP20❺	
AUXILIARY CONTACT CHARACTERISTICS				
Type of contact	n°	1-NO or NC based on configuration❻		
Thermal current Ith	A	10		
IEC/EN/BS 60947-5-1 designation	AC	A600		
	DC	Q600		
AMBIENT CONDITIONS				
Operating temperature	°C	-50...+70		
Storage temperature	°C	-60...+80		
Maximum altitude	m	3000		
Operating position	Normal	On vertical plane		
	Allowable	± 30°		
Fixing		Screw or on 35mm DIN rail		

- ❶ Rated voltage Ui for BGP... types is 500V.
- ❷ Derating for use at 61-400Hz. Consult Technical support for information (Tel. 035 4282422; E-mail: service@LovatoElectric.com).
- ❸ Current values guarantee an electrical life of about 50,000 cycles.
- ❹ Dimensions and drilling distances are given on page 2-36.
- ❺ IP20 protection warranted by wired equipment; minimum 0.75mm² conductor section.
- ❻ NO or NC auxiliary is highly conductive.
Other characteristics are the same as the mechanical characteristics of the poles.

TYPE				BG06	BG09	BG12
AC CONTROL						
Rated voltage at 50/60Hz, 60Hz		V		12...575		
Operating voltage limits						
50/60Hz coil powered at	50Hz	pick-up	% Us	75...115		
		drop-out	% Us	20...55		
	60Hz	pick-up	% Us	80...115		
		drop-out	% Us	20...55		
60Hz coil powered at	60Hz	pick-up	% Us	75...115		
		drop-out	% Us	20...55		
Average coil consumption at ≤20°C						
50/60Hz coil powered at	50Hz	in-rush	VA	30		
		holding	VA	4		
	60Hz	in-rush	VA	25		
		holding	VA	3		
60Hz coil powered at	60Hz	in-rush	VA	30		
		holding	VA	4		
Dissipation at ≤20°C	at 50Hz		W	0.95		

DC CONTROL						
Rated control voltage		V		6...250		
Operating voltage limits	pick-up	% Us		75...115		
	drop-out	% Us		10...25		
Average consumption at ≤20°C (in rush-holding)		W	3.2	3.2 ^①	3.2	

OPERATING TIMES						
Average time for Us control in	AC	closing NO	ms	12...21	12...21	12...21
		opening NO	ms	9...18	9...18	9...18
		closing NC	ms	17...26	17...26	17...26
		opening NC	ms	7...17	7...17	7...17
	DC	closing NO	ms	18...25	18...25	18...25
		opening NO	ms	2...3	2...3	2...3
		closing NC	ms	3...5	3...5	3...5
		opening NC	ms	11...17	11...17	11...17

LIFE			
Mechanical	AC control	cycles	20 million
	DC control	cycles	20 million
Electrical (Ie at 400V AC3)		cycles	500,000

MAXIMUM OPERATING RATE			
Mechanical operations	cy/h	3600	

① 2.3W for low-consumption type BG09...L.

ELECTRICAL RATINGS BASED ON IEC/EN/BS 60947-5-1 UTILIZATION CATEGORIES AND UL508/CSA C22.2 n°14

IEC/EN/BS designation	IEC/EN/BS utilization category	Conventional enclosed thermal current Ithe	Rated operational current Ie [A] at rated operational voltage Ue										VA rating			
UL designation	—	Thermal continuous test current	Maximum Amperes (AC) 60Hz										Maximum VA			
Alternating current		[A]	120VAC		240VAC		380VAC		480VAC		600VAC		Make	Break		
A600	AC-15	10	60	6	30	3	19	1.9	15	1.5	12	1.2	7200	720		
Direct current			Maximum Amperes (DC) Make or Break										300V or less ^②			
Q600	DC-13	2.5	125VDC	250VDC	301VDC	400VDC	500VDC	600VDC	0.55	0.27	0.1 ^③	0.15 ^③	0.13 ^③	0.1	69	69

② Value at 301V is valid for UL/CSA up to 600VDC; the others are valid for IEC/EN/BS.

③ Voltage valid for UL/CSA only.

IEC OPERATIONAL CHARACTERISTICS BF09-BF38

TYPE		BF09	BF12	BF18	BF25	BF26	BF32	BF38	
POLE CHARACTERISTICS									
Power poles	n°	3-4	3-4	3-4	3	3-4	3	3-4	
Rated insulation voltage Ui	V	690							
Rated impulse withstand voltage Uimp	kV	6							
Operational frequency	Hz	25...400 ^①							
Operational current	Conventional free air thermal Ith (≤40°C)	A	25	28	32	32	45	56	56(60 ^②)
	AC3 (≤440V ≤55°C)	A	9	12	18	25	26	32	38
	AC4 (400V) ^③	A	4.9	7.9	8.5	10	11.5	13.5	15.5
Short-time allowable current for 10s (IEC/EN/BS 60947-1)	A	150	150	200	200	210	320	320	
Max fuse size coordination Type 2 - 400V - 50kA	gG	A	25	32	32	50	50	63	63
	aM	A	10	12	20	25	32	32	40
Making capacity (RMS value)	A	90	120	180	250	260	320	380	
Breaking capacity at voltage	≤440V	A	72	96	144	200	208	256	304
	500V	A	72	96	120	184	184	240	240
	690V	A	71	94	94	102	168	192	192
Consumption and resistance per pole (average values)		mΩ	2.5	2.5	2.5	2.5	2.0	2.0	2.0
	Ith	W	1.6	2.0	2.6	2.6	4.0	6.0	6.0
	AC3	W	0.2	0.4	0.8	1.6	1.4	2.0	2.9
Terminals	Type	Clamp-screw							
	A	9.5	9.5	9.5	9.5	13	13	13	
	B	4.5	4.5	4.5	4.5	5.5	5.5	5.5	
	Screw	M3.5	M3.5	M3.5	M3.5	M4	M4	M4	
	Phillips	2	2	2	2	2	2	2	
	Phillips	2	2	2	2	2	2	2	
Tightening torque for pole terminal min-max	Nm	1.5...1.8	1,5...1.8	1.5...1.8	1.5...1.8	2.5...3	2.5...3	2.5...3	
	lb.in	13...16	13...16	13...16	13...16	22...27	22...27	22...27	
Tightening torque for coil terminals min-max	Nm	0.8...1	0.8...1	0.8...1	0.8...1	0.8...1	0.8...1	0.8...1	
	lb.in	7.1...8.8	7.1...8.8	7.1...8.8	7.1...8.8	7.1...8.8	7.1...8.8	7.1...8.8	
	Phillips	2	2	2	2	2	2	2	
Conductor section connectable with 1 or 2 wires min...max	AWG stranded	n°	16...8	16...8	16...8	16...8	14...6	14...6	14...6
	Flexible w/o lug	mm²	1...6	1...6	1...6	1...6	2.5...16	2.5...16	2.5...16
	Flexible c/w insulated boot-lace ferrule	mm²	1...4	1...4	1...4	1...4	1...10	1...10	1...10
	Flexible c/w insulated spade lug	mm²	1...4	1...4	1...4	1...4	1...10	1...10	1...10
Power terminal protection according to IEC/EN/BS 60529		IP20 ^④	IP20 ^⑤	IP20 ^⑥	IP20 ^⑥	IP20 ^④	IP20 ^④	IP20 ^④	

AUXILIARY CONTACT CHARACTERISTICS

Type of contact	n°	1-NO or NC based on configuration ^⑦					—
Thermal current Ith	A	10					—
IEC/EN/BS 60947-5-1 designation	AC	A600					—
	DC	P600					—

AMBIENT CONDITIONS

Operating temperature	°C	-50...+70						
Storage temperature	°C	-60...+80						
Maximum altitude	m	3000						
Operating position	Normal	On vertical plane						
	Allowable	± 30°						
Fixing		Screw or on 35mm DIN rail						

Products certified by UL / CSA as Elevator Equipment.

Type	Maximum horsepower ratings					
	Single phase		Three phase			
	120V	240V	200-208V	240V	480V	600V
	[HP]	[HP]	[HP]	[HP]	[HP]	[HP]
BF12 ^⑦	1/2	1 1/2	3	3	7 1/2	7 1/2
BF25 ^⑦	1 1/2	3	5	7 1/2	15	15
BF38 ^⑦	3	5	10	10	20	20
BF65 ^⑧	3	10	15	15	40	50
BF95 ^⑧	7.5	15	25	30	60	75
BF115 ^⑧	—	—	30	40	75	100
BF150 ^⑧	—	—	30	40	75	100

- ① Derating for use at 61-400Hz. Consult Technical support for information; see contact details on inside front cover.
- ② Current values guarantee an electrical life of about 200,000 cycles.
- ③ IP20 protection warranted by wired equipment; minimum 1mm² conductor section.
- ④ IP20 protection on front.
- ⑤ For this other current value, use 16mm² wire with spade cable terminal.
- ⑥ NO or NC auxiliary is highly conductive. Other characteristics are the same as the mechanical characteristics of the poles.
- ⑦ Elevator equipment by CSA (file LR54332-23) 500,000 operations.
- ⑧ Elevator equipment by cULus (file E93602) 500,000 operations.

2 Contactors

Technical characteristics

TYPE	BF09	BF12	BF18	BF25	BF26	BF32	BF38
AC CONTROL							
Rated voltage at 50/60Hz, 60Hz	V			12...600			
Operating voltage limits							
50/60Hz coil powered at	50Hz	pick-up	% Us	80...110			
		drop-out	% Us	20...55			
	60Hz	pick-up	% Us	85...110			
		drop-out	% Us	20...55			
60Hz coil powered at	60Hz	pick-up	% Us	80...110			
		drop-out	% Us	20...55			
Average coil consumption at ≤20°C							
50/60Hz coil powered at	50Hz	in-rush	VA	75			
		holding	VA	9			
	60Hz	in-rush	VA	70			
		holding	VA	6.5			
60Hz coil powered at 60Hz	60Hz	in-rush	VA	75			
		holding	VA	9			
Dissipation at holding ≤20°C	50Hz	W	2.5				

DC CONTROL - normal and low consumption								
Rated control voltage	V			6...415				
Operating limits								
pick-up	three-pole BF...D	from	% Us	70				
		to	% Us	125				
	four-pole BF...D	from	%Us	70		80		
		to	%Us	125		125		
	three and four pole BF...L	from	% Us	80				
		to	% Us	110				
drop-out for all versions	from	%Us	10					
	to	%Us	40					
Average coil consumption ≤20°C (in rush-holding)	BF...D	W	5.4					
	BF...L	W	2.4					

OPERATING TIMES									
Average time for AC Us control in	closing NO	ms	8...24					8...24	
		opening NO	ms	10...20					5...15
		closing NC	ms	14...28❶					9...20❷
		opening NC	ms	7...18❶					9...17❷
	DC BF...D types	closing NO	ms	54...66					53...65
		opening NO	ms	14...17					14...18
		closing NC	ms	24...30❸					23...28
		opening NC	ms	47...57❸					46...56
	DC BF...L types	closing NO	ms	75...91					76...92
		opening NO	ms	15...19					16...20
		closing NC	ms	24...30❹					25...31
		opening NC	ms	67...81❹					63...77

LIFE									
Mechanical (million)	AC control	cycles	20	20	20	20	20	20	20
	DC control	cycles	20	20	20	20	20	20	20
Electrical (1e at 400VAC3) (million)		cycles	2.0	2.0	1.6	1.2	1.6	1.6	1.4

MAXIMUM OPERATING RATE									
Mechanical operations	cy/h	3600							

- ❶ NC closing time for BF...TOA types is 9...25ms while NC opening time is 9...15ms.
- ❷ NC closing time for BF...TOA types is 11...29ms while NC opening time is 6...14ms.
- ❸ NC closing time for BF...TOD types is 23...29ms while NC opening time is 40...49ms.
- ❹ NC closing time for BF...TOL types is 25...31ms while NC opening time is 56...68ms.

ELECTRICAL RATINGS BASED ON IEC/EN/BS 60947-5-1 UTILIZATION CATEGORIES AND UL508/CSA C22.2 n°14

IEC/EN/BS designation	IEC/EN/BS utilization category	Conventional enclosed thermal current Ithe	Rated operational current Ie [A] at rated operational voltage Ue										VA rating	
UL designation	—	Thermal continuous test current	Maximum Amperes (AC) 60Hz										Maximum VA	
			120VAC		240VAC		380VAC		480VAC		600VAC			
			Make	Break	Make	Break	Make	Break	Make	Break	Make	Break	Make	Break
Alternating current		[A]	60	6	30	3	19	1.9	15	1.5	12	1.2	7200	720
A600	AC-15	10												
			Maximum Amperes (DC) Make or Break										300V or less	
			125VDC	250VDC	301VDC	400VDC	500VDC	600VDC						
P600	DC-13	5	1.1	0.55	0.2	0.31	0.27	0.2	138 138					

IEC OPERATIONAL CHARACTERISTICS BF40...BF150...

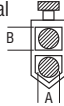
TYPE		BF40	BF50	BF65	BF80	BF94	BF95	BF115	BF150	
POLE CHARACTERISTICS										
Power poles	N°	3-4	3-4	3-4	3-4	3	3-4	3-4	3-4	
Rated insulation voltage U_i	V	1000								
Rated impulse withstand voltage U_{imp}	kV	8								
Operational frequency	Hz	25 ... 400 ^①								
Operational current	Conventional free air thermal I_{th} ($\leq 40^\circ\text{C}$)	A	70	90	100	115	115	140	160	165
	AC3 ($\leq 440\text{V}$ $\leq 55^\circ\text{C}$)	A	40	50	65	80	95	95	115	150
	AC4 (400V) ^②	A	24	28	31	38	45	45	54	70
Short-time allowable current for (IEC/EN/BS 60947-1)	10s	A	400	400	640	640	640	760	920	1200
Maximum fuse size coordination Type 2 - 400V - 50kA	gG	A	100	100	125	125	125	160	200	250
	aM	A	50	50	80	80	100	100	125	160
Making capacity (RMS value)	A	400	500	650	800	950	1200	1500	1500	
Breaking capacity at voltage	$\leq 440\text{V}$	A	320	400	520	640	760	1100	1200	1200
	500V	A	265	352	425	625	660	775	850	1025
	690V	A	256	312	376	456	475	745	905	905
Consumption and resistance per pole (average values)	m Ω		0.8	0.8	0.8	0.6	0.6	0.45	0.45	0.45
	I_{th}	W	3.9	6.5	8.0	7.9	7.9	8.8	11.5	12
	AC3	W	1.3	2.0	3.4	3.8	5.4	4.1	6.0	10.1
Terminals	Type	Double lug clamp terminal 								
	A [mm]	9.5							15	
	B [mm]	11							14.5	
	Screw	M6							M8	
	Metric Allen	4							4	
	Tightening torque for pole terminal min-max	Nm	4...5							6...7
lb.in		35.4...44.3							53.1...61.9	
Tightening torque for coil terminals min-max	Nm	0.8...1								
	lb.in	7.1...8.8								
	Phillips	2								
Conductor section connectable with 1 or 2 wires min...max	AWG	N°	14...2				14...2/0			
	Flexible w/o lug	mm ²	1.5...35				1.5...70			
	Flexible c/w lug	mm ²	1.5...35				1.5...70			
Power terminal protection according to IEC/EN/BS 60529		IP20 front								
AMBIENT CONDITIONS										
Operating temperature	°C	-50...+70 ^③								
Storage temperature	°C	-60...+80 ^④								
Maximum altitude	m	3000								
Operating position	Normal	On vertical plane								
	Allowable	$\pm 30^\circ$								
Fixing		Screw or on 35mm DIN rail					Screw or on 35mm DIN rail ^⑤			

- ① Derating for use at 61-400 Hz. Consult Technical support for information; see contact details on inside front cover.
- ② Current values guarantee an electrical life of about 200,000 cycles.
- ③ -40...+70 for BF40...150E.
- ④ -50...+80 for BF40...150E.
- ⑤ Din rail height 15mm (TH35-15)

Products certified by UL / CSA as Elevator Equipment.
See table on page 2-70.

2 Contactors

Technical characteristics

TYPE				BF40	BF50	BF65	BF80	BF94	BF95	BF115	BF150
AC CONTROL											
Rated voltage at 50/60Hz, 60Hz		V		12...600 (20...250 electronically controlled AC/DC coil)							
Operating voltage limits											
50/60Hz coil powered at	50Hz	pick-up	% Us	80...110 ①							
		drop-out	% Us	20...55 (≤70% electronically controlled AC/DC coil)							
60Hz coil powered at	60Hz	pick-up	% Us	85...110 ①							
		drop-out	% Us	40...55 (≤70% electronically controlled AC/DC coil)							
Average coil consumption at ≤20°C											
50/60Hz coil powered at	50Hz	in-rush	VA	210 (35...120 electronically controlled AC/DC coil)				300 (70...175 electronically controlled AC/DC coil)			
		holding	VA	15 (1.5...3.7 electronically controlled AC/DC coil)				20 (1.7...3.5 electronically controlled AC/DC coil)			
	60Hz	in-rush	VA	195 (35...120 electronically controlled AC/DC coil)				275 (70...175 electronically controlled AC/DC coil)			
		holding	VA	13 (1.5...3.7 electronically controlled AC/DC coil)				17 (1.7...3.5 electronically controlled AC/DC coil)			
60Hz coil powered at	60Hz	in-rush	VA	210				300			
		holding	VA	15				20			
Dissipation at ≤20°C		50Hz	W	5 (1...2.5 electronically controlled AC/DC coil)				6.5 (1.5...3 electronically controlled AC/DC coil)			
DC CONTROL											
Rated voltage		V		20...250							
Operating voltage limits	pick-up	% Us		80...110 ①							
		drop-up	% Us		≤75% Us min						
Average consumption ≤20°C (in rush-holding)			W	23...68 / 1.2...1.9				70...80 / 1.3...1.5			
OPERATING TIMES											
Average time for Us control in	AC	closing NO	ms	12...28 (40...85 electronically controlled AC/DC coil)				16...32 (45...90 electronically controlled AC/DC coil)			
		opening NO	ms	8...22 (20...55 electronically controlled AC/DC coil)				9...24 (24...60 electronically controlled AC/DC coil)			
	DC	closing NO	ms	40...85 (electronically controlled AC/DC coil)				45...90 (electronically controlled AC/DC coil)			
		opening NO	ms	20...55 (electronically controlled AC/DC coil)				24...60 (electronically controlled AC/DC coil)			
LIFE											
Mechanical (million)	AC control	cycles	15	15	15	15	15	15	15	15	15
	DC control	cycles	15	15	15	15	15	15	15	15	15
Electrical (Ie at 400V in AC3) (million)		cycles	1.5	1.4	1.4	1.3	1.1	1.4	1.2	0.8	
MAXIMUM OPERATING RATE											
Mechanical operations		cy/h	1500 (2000 for BF40...E...BF150...E...)								

① For electronically controlled AC/DC coils 80% of Us min. and 110% of Us max; for 20...48V 85% of Us min when powered in AC; 77% of Us min for 100...250V coils.
 ② Electromagnetic compatibility: BF40...94E contactors with electronic coil 20...48VAC/DC are in compliance with IEC/EN/BS 60947-1 and IEC/EN/BS 60947-1 standards for Environment B (domestic). The other devices are in compliance for Environment A (industrial) and can be upgraded to Environment B connecting proper filters; consult Technical support for information - see contact details on inside front cover.

IEC OPERATIONAL CHARACTERISTICS BF160...BF230 and B250...B1600

TYPE		BF160	BF195	BF230	B250	B310	B400	B500	B630	B630 1000	B1250	B1600	
POLE CHARACTERISTICS													
Power poles	n°	3-4	3-4	3-4	3-4	3-4	3-4	3-4	3-4	3-4	3-4	3-4	
Rated insulation voltage Ui	V	1000											
Rated impulse withstand voltage Uimp	kV	8											
Operational frequency	Hz	25-400 ^①											
Operational current	Conventional free air thermal Ith (≤40°C)	A	250	275	350	350	450	550	700	800	1000	1250	1600
	AC3 (≤440V ≤55°C)	A	160	195	230	265	320	420	520	630	–	–	–
	AC4 (400V) ^②	A	75	95	110	115	150	200	240	260	–	–	–
Short-time allowable current for 10s (IEC/EN/BS 60947-1)	A	1280	1560	1840	2200	2900	3600	4050	5040	5600	6500	8300	
Maximum fuse size coordination Type 2 - 400V - 50kA	gG	A	315	315	400	400	500	630	800	1000	1000	1250	1600
	aM	A	200	250	250	250	400	400	500	630	–	–	–
Making capacity (RMS value)	A	1360	1658	1955	2750	3150	4200	5000	6300	6300	6300	6300	
Breaking capacity at voltage	≤440V	A	1360	1658	1955	2500	3000	4000	5000	6300	6300	6300	6300
	500V	A	1326	1326	1564	2250	2700	3400	4500	5600	5600	5600	5600
	690V	A	1139	1377	1377	2200	2520	3360	4000	5000	5000	5000	5000
	1000V	A	468	553	638	1500	1700	2300	2700	3400	3400	3400	3400
Consumption and resistance per pole (average values)	mΩ	0.18	0.18	0.18	0.20	0.20	0.20	0.14	0.14	0.14	0.07	0.07	
	Ith	W	11	13	21	24.5	40.5	52.0	68.6	90	140	110	180
	AC3	W	4.5	6.7	9.3	12.5	20	32	35.0	56	–	–	–
Terminals		A mm	18	18	18	25	25	25	35	40	60	80	80
		B mm	5	5	5	5	5	5	6	6	6	10	10
		Screw + hex nut	M8	M8	M8	M10	M10	M10	M10	M12	2xM12	2xM12	2xM12
		Key mm	13	13	13	17	17	17	17	19	19	19	19
Coil terminals	Type	Screw			Faston 1x6.35 o 2x2.8								
Pole tightening torque	Nm	18	18	18	35	35	35	35	55	55	55	55	
	lb.in	159	159	159	310	310	310	310	486	486	486	486	
Tightening torque for coil terminals min-max	Nm	0.8...1			0.8...1 ^③								
	lb.in	7.1...8.8			7.1...8.8 ^③								
	Phillips	2			2 ^③								
Maximum conductor section	mm 1 or 2 bars	25x5	25x5	25x5	30x4	30x5	30x5	50x5	60x5	60x5	100x5	100x5	
	N° 1 wire with lug	mm ² 185			240	–	–	–	–	–	–	–	
	N° 2 wire with lug	mm ² 185			–	150	150	240	240	–	–	–	
AMBIENT CONDITIONS													
Operating temperature	°C	-40...+70				-50...+70				-20...+60			
Storage temperature	°C	-50...+80				-60...+80				-30...+80			
Maximum altitude	m	3000											
Operating position	Normal	Vertical											
	Allowable	± 30°											
Fixing		Screw											

① Derating for use at 61-400 Hz. Consult Technical support for information (Tel. 035 4282422; E-mail: service@LovatoElectric.com).

② Current values guarantee an electrical life of about 200,000 cycles.

③ G371: Adapter to transform coil faston terminals into screw type.

TYPE		BF160	BF195	BF230	B250	B310	B400	B500	B630	B630 1000	B1250	B1600	
AC CONTROL													
Supply voltage		50/60Hz, DC				Either in AC/DC						Only AC	
Rated control voltage	V	20...500				24...480	24...480	24...480	48...480	48...480	48...480	110/240	110/240
Operating voltage limits	pick-up	% Us	80...110				80...110	80...110	80...110	80...110	80...110	80...110	80...110
	drop-out	% Us	≤70% Us min				20...60	20...60	20...60	20...60	20...60	20...60	20...60
Consumption at ≤20°C	in-rush	VA/W	160...230				300	300	300	400	400	400	800
	holding	VA/W	1.5...3.0				10	10	10	18	18	18	45
Dissipation at ≤20°C	W	1.5...3.0				10	10	10	18	18	18	40	
OPERATING TIMES													
Making	ms	50...100				80...120	80...120	80...120	110...180	110...180	110...180	120...210	300...450
Breaking	ms	30...75				30...75	30...75	30...75	60...100	60...100	60...110	70...130	70...130
LIFE													
Mechanical (million)	AC/DC	cycles	10	10	10	10	10	10	5	5	5	5	
Electrical (million) (I _e at 400V in AC3)		cycles	1	1	1	1	0.9	0.7	0.7	0.7	–	–	
MAXIMUM OPERATING RATE													
Mechanical operations	cy/h	1000				2400				1200			
PARTICULAR CHARACTERISTICS													
Indicator		For contactor open or closed status											

● 80% of Us min and 110% of Us max.

CONTROL CIRCUIT UTILISATION

The input electronic circuit of the contactor coil B250-B1600 is designed and tested according to IEEEC 62.41 and can withstand a 10 kV impulse voltage (1.2/50µs) with 50 Joule energy. For higher values, the use of an auxiliary step-down voltage transformer is recommended.

CONTACTORS WITH MECHANICAL LATCH

Contactors B250-B630 type, can have mechanical latch included or can be predisposed, to be completed with mechanical latch, see pages 2-6 and 2-8 (3-pole version) or 2-10 and 2-12 (4-pole version). Technical data of mechanical latch G495 type is stated on page 2-30.

MECHANICAL INTERLOCK BETWEEN CONTACTORS ONE ON TOP OF THE OTHER

B250...B1600... (Fig. 1, 2 and 3)

It is G356... type, which is provided in six types to allow different fixing interaxis of contactors.

Contactors of the same size can be interlocked as well as different sizes.

INTERAXIS A [mm] - For contactors with terminal protection (Fig. 1)

KM1	B250-B310-B400		B500-B630	
KM2	B250 B310 B400	B500 B630	B250 B310 B400	B500 B630
G3562	—	—	—	—
G3563	—	—	—	—
G3564	372...385	—	—	—
G3565	390...425	420...425	420...425	—
G3566	470...500	470...500	470...500	470...500

To interlock two contactors B6301000, use type G3566 only.

To interlock two contactors B1250 or B1600, it is imperative to use two pieces of type G3566 (fig. 3), one fixed on the left side and the other on the right.

The tables below indicate the interaxis which can be obtained with the various interlock types; with terminal protections (INTERAXIS A) and without terminal protection (INTERAXIS B).

INTERAXIS B [mm] - For contactors without terminal protection (Fig. 2)

KM1	B250-B310-B400		B500-B630	
KM2	B250 B310 B400	B500 B630	B250 B310 B400	B500 B630
G3562	265...305	—	—	—
G3563	305...345	305...345	305...345	—
G3564	345...385	345...385	345...385	345...385
G3565	390...425	390...425	390...425	390...425
G3566	470...500	470...500	470...500	470...500

Interaxis B is 470-500mm for B630 1000, B1250 or B1600.

The B1250 or B1600 cannot be interlocked with the other types of the B series.

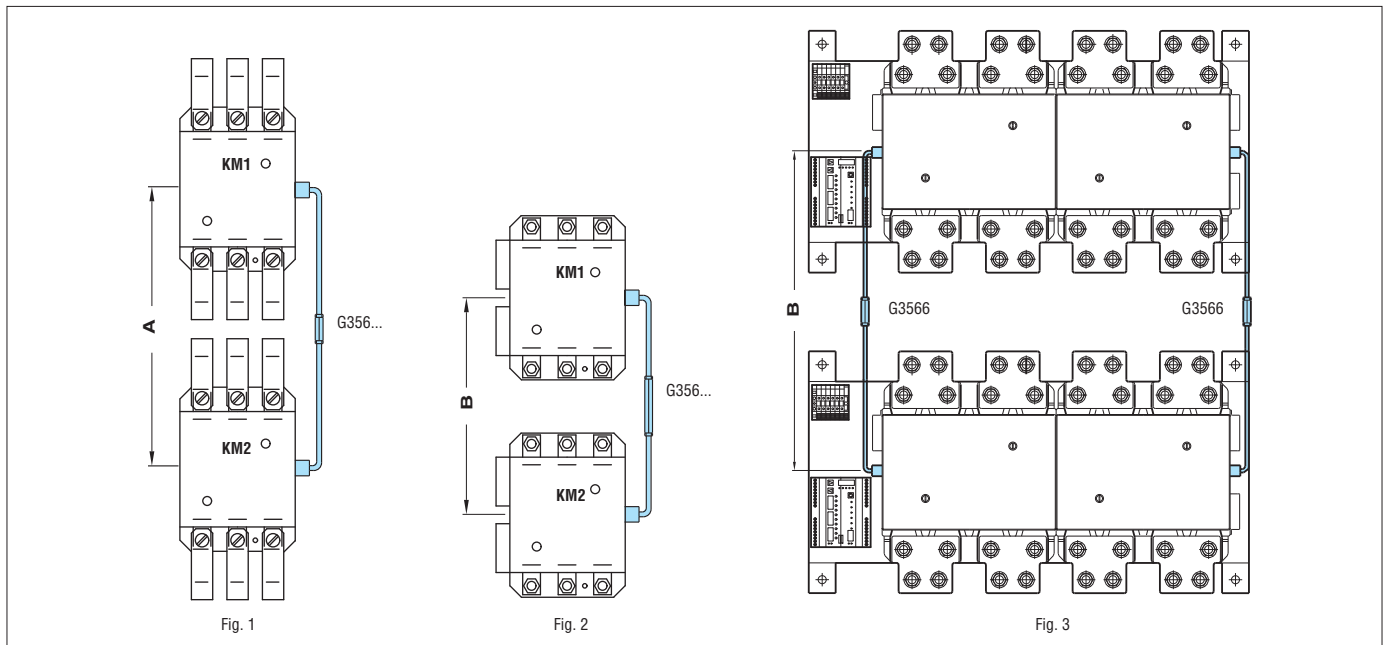

Horizontal and vertical interlock between contactors B250...B630. It is G355 type and can interlock both contactors of equal size and contactors of different sizes (e.g. B250 can be interlocked with B630). For contactor B630 1000 (three-pole), contact our Technical support office. This interlock cannot be applied to contactors B1250-B1600.

Admissible mounting positions for 11G350 and 11G354 auxiliary contacts on contactors equipped with mechanical interlock:

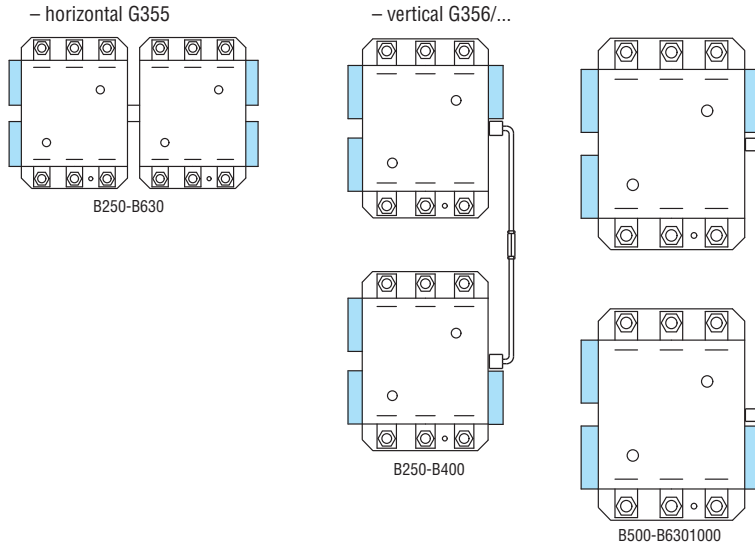

Admissible mounting positions for 11G358 adapter on contactors equipped with mechanical interlock:

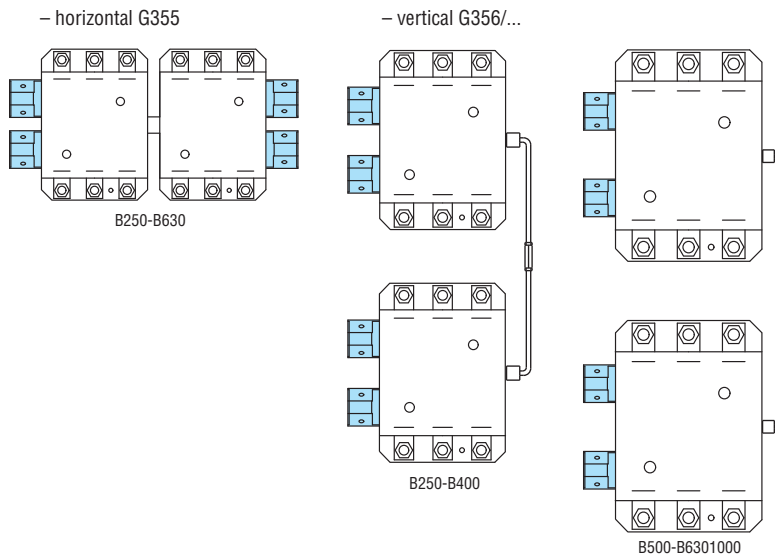



- Thermal overload relays for currents between 0.09 and 420A
- Electronic thermal overload relays for currents between 0.4 and 45A
- Electronic thermal overload relays with selectable tripping class: 5-10-20-30
- Phase failure sensitive and non phase failure sensitive versions
- Automatic and/or manual resetting
- Independent or direct mounting on contactor
- Thermistor protection relay.

	SEC. - PAGE
Thermal overload relays	
For BG series mini-contactors	3 - 2
For BF series contactors	3 - 4
For BF and B series contactors	3 - 8
Accessories	3 - 10
Electronic thermal overload relays	
For BF series contactors	3 - 11
Electronic relay	
Thermistor protection relays	3 - 12
Dimensions	3 - 13
Wiring diagrams	3 - 14
Technical characteristics	3 - 15

Type of contactor	TYPE OF THERMAL OVERLOAD RELAY				Pages	ELECTRONIC THERMAL OVERLOAD RELAYS	
	Phase failure / single phase sensitive		Non phase failure / non single phase sensitive			Phase failure / single phase sensitive Manual/hand or automatic reset	Pages
	Manual/hand reset	Automatic reset	Manual/hand reset	Automatic reset			
BG06...BG12	RF9	RFA9	RFN9	RFNA9	3-2 and 3-3	—	—
BF09...BF38	RF38		RFN38		3-4 and 3-6	RFE45	3-11
BF40...BF94	RF82	RFA82	RFN82	RFNA82	3-5 and 3-7	—	—
BF95...BF150❶	RF110	RFA110	RFN110	RFNA110	3-5 and 3-7	—	—
BF160...BF230	RF200		RFN200		3-8 and 3-9	—	—
BF195...BF230 / B310...B400	RF400		RFN400				

❶ For currents higher than 110A use RF200 (independent mounting).



Page 3-2

FOR BG SERIES MINI-CONTACTORS

- Type RF9, phase failure sensitive, manual resetting
- Type RFA9, phase failure sensitive, automatic resetting
- Type RFN9, non phase failure sensitive, manual resetting
- Type RFNA9, non phase failure sensitive, automatic resetting.



Page 3-4

FOR BF SERIES CONTACTORS

- Type RF38, phase failure sensitive, manual or automatic resetting
- Type RFN38, non phase failure sensitive, manual or automatic resetting
- Type RF82 and RF110, phase failure sensitive, manual resetting
- Type RFA82 and RFA110, phase failure sensitive, automatic resetting
- Type RFN82 and RFN110, non phase failure sensitive, manual resetting
- Type RFNA82 and RFNA110, non phase failure sensitive, automatic resetting.



Page 3-8

FOR BF AND B SERIES CONTACTORS

- Type RF200 and RF420, phase failure sensitive, manual or automatic resetting
- Type RFN200 and RFN420, non phase failure sensitive, manual or automatic resetting.



Page 3-11

ELECTRONIC THERMAL OVERLOAD RELAYS FOR BF SERIES CONTACTORS

- Phase failure sensitive, manual or automatic resetting
- Selectable tripping class: 5-10-20-30
- High reliability and accuracy of tripping
- Minimal heat dissipation
- Wide current adjustment range.



Page 3-12

THERMISTOR PROTECTION RELAY

- 24VDC and 24 to 240VAC supply types.



LOVATO Electric motor protection relays are suitable for new motors with high IE3 efficiency values

RF38 features

FRONT PROTECTION COVER OF THERMAL OVERLOAD RELAYS

A sealable protection cover is available. When fitted on to the relay front, it precludes all possible adjuster tampering and involuntary activation of the "Reset" and "Stop" buttons of the thermal overload relay.



CLEAR IDENTIFICATION OF THERMAL OVERLOAD RELAY MANUAL OR AUTOMATIC RESETTING

The RF38 thermal overload relay is supplied configured for manual resetting. Breaking the plate below the "Reset" button allows for the automatic resetting configuration.



FIXING EASE OF THE THERMAL OVERLOAD RELAY

While the thermal overload relay is being linked to the contactor, its auxiliary contact fits on and connects to the coil terminal by rigid terminal. Complete relay fixing is done in a single operation, with no need of other connections.

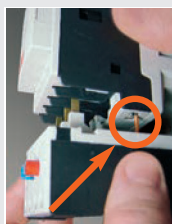

SEALABLE RELAY COVER

A handy closing flap feature excludes any tampering of the thermal overload relay adjuster.



3 Motor protection relays

Thermal overload relays.
For BG series mini-contactors

**Phase failure /
single phase sensitive
Three poles (three phase)**



11RF9...



11RFA9...

Order code	Adjustment range	Protection fuses			Qty per pkg	Wt [kg]
		IEC aM	gG	UL K5		
	[A]	[A]	[A]	[A]	n°	

MANUAL RESETTING.
Direct mounting on BG06, BG09, BG12 mini-contactors.

11RF9015	0.09...0.15	0.25	—	—	1	0.116
11RF9023	0.14...0.23	0.5	—	1	1	0.116
11RF9033	0.2...0.33	0.5	1	1	1	0.116
11RF905	0.3...0.5	1	2	3	1	0.116
11RF9075	0.45...0.75	1	2	3	1	0.116
11RF91	0.6...1	2	4	3	5	0.116
11RF91V5	0.9...1.5	2	4	6	5	0.116
11RF92V3	1.4...2.3	4	6	10	5	0.116
11RF933	2...3.3	4	10	10	5	0.116
11RF95	3...5	6	16	15	5	0.116
11RF975	4.5...7.5	8	20	25	5	0.116
11RF910	6...10	10	32	30	5	0.116
11RF915	9...15	16	40	45	5	0.116

AUTOMATIC RESETTING.
Direct mounting on BG06, BG09, BG12 mini-contactors.

11RFA9015	0.09...0.15	0.25	—	—	1	0.116
11RFA9023	0.14...0.23	0.5	—	1	1	0.116
11RFA9033	0.2...0.33	0.5	1	1	1	0.116
11RFA905	0.3...0.5	1	2	3	1	0.116
11RFA9075	0.45...0.75	1	2	3	1	0.116
11RFA91	0.6...1	2	4	3	1	0.116
11RFA91V5	0.9...1.5	2	4	6	1	0.116
11RFA92V3	1.4...2.3	4	6	10	1	0.116
11RFA933	2...3.3	4	10	10	1	0.116
11RFA95	3...5	6	16	15	1	0.116
11RFA975	4.5...7.5	8	20	25	1	0.116
11RFA910	6...10	10	32	30	1	0.116
11RFA915	9...15	16	40	45	1	0.116

NOTE: two pole (single phase) versions are available on request.
Add the letter "S" in the order code e.g. 11RF9015 is three pole; 11RFS9015 two pole.
The appropriate adjustment range of the overload relay should be selected on the basis of the motor nameplate full-load current when direct, across the line starting is considered.

Three-phase IEC motor powers ①

230V [kW]	400V [kW]	500V [kW]	690V [kW]
-----------	-----------	-----------	-----------

0.06	0.06	0.06	0.06
0.09	0.09	0.09	0.09
0.12	0.12	0.12	0.12
0.18	0.18	0.18	0.18
0.25-0.37	0.25-0.37	0.25-0.37	0.25-0.37
0.55	0.55	0.55	0.55
0.75	0.75	0.75	0.75
1.1-1.5	1.1-1.5	1.1-1.5	1.1-1.5
2.2	2.2	2.2	2.2
3	3	3	3

0.06	0.06	0.06	0.06
0.09	0.09	0.09	0.09
0.12	0.12	0.12	0.12
0.18	0.18	0.18	0.18
0.25-0.37	0.25-0.37	0.25-0.37	0.25-0.37
0.55	0.55	0.55	0.55
0.75	0.75	0.75	0.75
1.1-1.5	1.1-1.5	1.1-1.5	1.1-1.5
2.2	2.2	2.2	2.2
3	3	3	3

- ① The indicated powers apply to 4-pole motors; it is advisable to always check that the nameplate motor current is within the relay adjustment range.
- ② No standard power ratings exist; select relay according to current consumption.

NOTE: to facilitate connection between the auxiliary NC contact of the RF...9 thermal relay and terminal A2 of the contactor, insert the conductor into the appropriate conduit as shown.

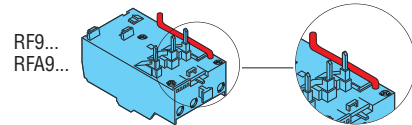

Certifications and compliance

Certifications obtained:

Type	cULus	CSA	EAC	CCC
RF9... - RFA9...	●	●	●	●

● Certified products.

cULus – UL Listed for USA and Canada (cULus - File E93601) as Auxiliary Devices – Thermal Overload Relays, 600VAC, open type, ambient compensated, 5000 Amps RMS symmetrical short circuit rating; the trip current is 120% FLA.

CSA – CSA certified for Canada only (File 54332) as Auxiliary Devices for use with magnetic contactors.

Compliant with standards: IEC/EN/BS 60947-1, IEC/EN/BS 60947-4-1, UL 60947-1, UL 60947-4-1, CSA C22.2 n° 60947-1, CSA C22.2 n° 60947-4-1.

3 Motor protection relays

Thermal overload relays.
For BG series mini-contactors

**Non phase failure /
non single phase sensitive
Three poles (three phase)**



11RFN9...



11RFNA9...

Order code	Adjustment range	Protection fuses			Qty per pkg	Wt [kg]
		IEC aM [A]	gG [A]	UL K5 [A]		
	[A]	[A]	[A]	[A]	n°	[kg]

MANUAL RESETTING.
Direct mounting on BG06, BG09, BG12 mini-contactors.

11RFN9015	0.09...0.15	0.25	—	—	1	0.123
11RFN9023	0.14...0.23	0.5	—	1	1	0.123
11RFN9033	0.2...0.33	0.5	1	1	1	0.123
11RFN905	0.3...0.5	1	2	3	1	0.123
11RFN9075	0.45...0.75	1	2	3	1	0.123
11RFN91	0.6...1	2	4	3	1	0.123
11RFN91V5	0.9...1.5	2	4	6	1	0.123
11RFN92V3	1.4...2.3	4	6	10	1	0.123
11RFN933	2...3.3	4	10	10	1	0.123
11RFN95	3...5	6	16	15	1	0.123
11RFN975	4.5...7.5	8	20	25	1	0.123
11RFN910	6...10	10	32	30	1	0.123
11RFN915	9...15	16	40	45	1	0.123

AUTOMATIC RESETTING.
Direct mounting on BG06, BG09, BG12 mini-contactors.

11RFNA9015	0.09...0.15	0.25	—	—	1	0.123
11RFNA9023	0.14...0.23	0.5	—	1	1	0.123
11RFNA9033	0.2...0.33	0.5	1	1	1	0.123
11RFNA905	0.3...0.5	1	2	3	1	0.123
11RFNA9075	0.45...0.75	1	2	3	1	0.123
11RFNA91	0.6...1	2	4	3	1	0.123
11RFNA91V5	0.9...1.5	2	4	6	1	0.123
11RFNA92V3	1.4...2.3	4	6	10	1	0.123
11RFNA933	2...3.3	4	10	10	1	0.123
11RFNA95	3...5	6	16	15	1	0.123
11RFNA975	4.5...7.5	8	20	25	1	0.123
11RFNA910	6...10	10	32	30	1	0.123
11RFNA915	9...15	16	40	45	1	0.123

NOTE: the appropriate adjustment range of the overload relay should be selected on the basis of the motor nameplate full-load current when direct, across the line starting is considered.

Three-phase IEC motor powers

230V [kW]	400V [kW]	500V [kW]	690V [kW]
-----------	-----------	-----------	-----------

0.06	0.06	0.06	0.06
0.06	0.06	0.06	0.09
0.06	0.09	0.09	0.12
0.06	0.12	0.12	0.18
0.09-0.12	0.18	0.18	0.25-0.37
0.12	0.25	0.25-0.37	0.55
0.18	0.37	0.55	0.75
0.25-0.37	0.55-0.75	0.75	1.1-1.5
0.55	1.1	1.1-1.5	1.5-2.2
0.75	1.5	2.2	3
1.1-1.5	2.2-3	3-4	4-5.5
2.2	4	4-5.5	7.5
3	5.5	7.5	11

0.06	0.06	0.06	0.06
0.06	0.06	0.06	0.09
0.06	0.09	0.09	0.12
0.06	0.12	0.12	0.18
0.09-0.12	0.18	0.18	0.25-0.37
0.12	0.25	0.25-0.37	0.55
0.18	0.37	0.55	0.75
0.25-0.37	0.55-0.75	0.75	1.1-1.5
0.55	1.1	1.1-1.5	1.5-2.2
0.75	1.5	2.2	3
1.1-1.5	2.2-3	3-4	4-5.5
2.2	4	4-5.5	7.5
3	5.5	7.5	11

- ① The indicated powers apply to 4-pole motors; it is advisable to always check that the nameplate motor current is within the relay adjustment range.
- ② No standard power ratings exist; select relay according to current consumption.

NOTE: to facilitate connection between the auxiliary NC contact of the RFN...9 thermal relay and terminal A2 of the contactor, insert the conductor into the appropriate conduit as shown.

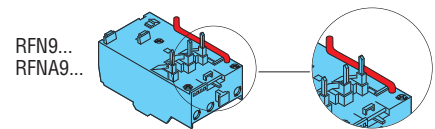

Certifications and compliance

Certifications obtained:

Type	cULus	CSA	EAC	CCC
RFN9... - RFNA9...	●	●	●	●

● Certified products.

cULus – UL Listed for USA and Canada (cULus - File E93601) as Auxiliary Devices – Thermal Overload Relays, 600VAC, open type, ambient compensated, 5000 Amps RMS symmetrical short circuit rating; the trip current is 120% FLA.

CSA – CSA certified for Canada only (File 54332) as Auxiliary Devices for use with magnetic contactors.

Compliant with standards: IEC/EN/BS 60947-1, IEC/EN/BS 60947-4-1, UL 60947-1, UL 60947-4-1, CSA C22.2 n° 60947-1, CSA C22.2 n° 60947-4-1.

3 Motor protection relays

Thermal overload relays.
For BF series contactors

**Phase failure /
single phase sensitive
Three poles (three phase)**



RF38...

Order code	Adjustment range	Protection IEC aM	fuses gG [A]	UL RK5 [A]	Qty per pkg n°	Wt [kg]
	[A]	[A]	[A]	[A]	n°	[kg]

MANUAL OR AUTOMATIC RESETTING.
Direct mounting on BF09...BF38 contactors.
Independent mounting with RFX3804 base.

RF380016	0.1...0.16	0.25	—	1	1	0.160
RF380025	0.16...0.25	0.5	—	1	1	0.160
RF380040	0.25...0.4	0.5	1	3	1	0.160
RF380063	0.4...0.63	1	2	3	1	0.160
RF380100	0.63...1	2	4	3	5	0.160
RF380160	1...1.6	2	4	6	5	0.160
RF380250	1.6...2.5	4	6	10	5	0.160
RF380400	2.5...4	4	6	15	5	0.160
RF380650	4...6.5	8	16	25	5	0.160
RF381000	6.3...10	10	20	40	5	0.160
RF381400	9...14	16	32	50	5	0.160
RF381800	13...18	25	40	70	5	0.160
RF382300	17...23	25	50	90	5	0.160
RF382500	20...25	32	50	100	5	0.160
RF383200	24...32	40	63	120	1	0.160
RF383800	32...38	40	63	150	1	0.160

NOTE: two pole (single phase) versions are available on request.
Add the letter "S" in the order code e.g. RF381000 is three pole; RFS381000 two pole.

The appropriate adjustment range of the overload relay should be selected on the basis of the motor nameplate full-load current when direct, across the line starting is considered.

Three-phase IEC motor powers ②

230V [kW]	400V [kW]	500V [kW]	690V [kW]
-----------	-----------	-----------	-----------

②	②	②	0.06
②	0.06	0.06-0.09	0.09-0.12
0.06	0.09	0.12	0.18
0.09	0.12-0.18	0.18	0.25
0.12	0.25	0.25-0.37	0.37-0.55
0.18-0.25	0.37-0.55	0.55-0.75	0.75
0.37	0.75	1.1	1.1-1.5
0.55-0.75	1.1-1.5	1.5-2.2	2.2-3
1.1-1.5	2.2	3	4
1.5-2.2	3-4	4-5.5	5.5-7.5
3	5.5	5.5-7.5	11
4	7.5	11	15
5.5	11	11	18.5
5.5	11	15	22
7.5	15	18.5	30
11	18.5	22	30

② No standard powers ratings exist; select relay according to current consumption.

③ The indicated powers apply to 4-pole motors; it is advisable to always check that the nameplate motor current is within the relay adjustment range.

Certifications and compliance

Certifications obtained:

Type	cULus	CSA	EAC	CCC	Register of shipping LORS
RF38	●	—	●	●	—

● Certified products.

cULus – UL Listed for USA and Canada (cULus - File E93601) as Auxiliary Devices – Thermal Overload Relays, 600VAC, open type, ambient compensated, 5000 Amps RMS symmetrical short circuit rating up to 82A FLA range and 10000 Amps RMS for 95A and 110A FLA range; the trip current is 120% FLA.

CSA – CSA certified for Canada only (File 54332) as Auxiliary Devices for use with magnetic contactors.

Compliant with standards: IEC/EN/BS 60947-1, IEC/EN/BS 60947-4-1, UL 60947-1, UL 60947-4-1, CSA C22.2 n° 60947-1, CSA C22.2 n° 60947-4-1.

FIXING EASE OF THE THERMAL OVERLOAD RELAY

While the thermal overload relay is being linked to the contactor, its auxiliary contact fits on and connects to the coil terminal by rigid terminal. Complete relay fixing is done in a single operation, with no need of other connections.

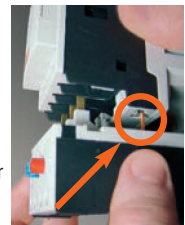

3 Motor protection relays

Thermal overload relays.
For BF series contactors

Phase failure / single phase sensitive Three poles (three phase)



RF82...



RF110...



RFA82...



RFA110...

Order code	Adjustment range	Protection fuses			Qty per pkg	Wt [kg]
		IEC aM	gG	UL RK5		
	[A]	[A]	[A]	[A]	n°	

MANUAL RESETTING.
Direct mounting on BF40...BF94 contactors.
Independent mounting with 11G270 base.

RF823300	20...33	40	63	110	1	0.365
RF824200	28...42	50	80	150	1	0.365
RF825000	35...50	50	100	175	1	0.365
RF826500	46...65	80	125	200	1	0.365
RF828200	60...82	100	200	250	1	0.365
RF829500	70...95	100	200	250	1	0.365

MANUAL RESETTING.
Direct mounting on BF95...BF150 contactors[Ⓜ].
Independent mounting with 11G270 base.

RF110082	60...82	100	200	250	1	0.365
RF110095	70...95	100	200	350	1	0.365
RF110110	90...110	125	200	350	1	0.365

AUTOMATIC RESETTING.
Direct mounting on BF40...BF94 contactors.
Independent mounting with 11G270 base.

RFA823300	20...33	40	63	110	1	0.365
RFA824200	28...42	50	80	150	1	0.365
RFA825000	35...50	50	100	175	1	0.365
RFA826500	46...65	80	125	200	1	0.365
RFA828200	60...82	100	200	250	1	0.365
RFA829500	70...95	100	200	250	1	0.365

AUTOMATIC RESETTING.
Direct mounting on BF95...BF150 contactors[Ⓜ].
Independent mounting with 11G270 base.

RFA110082	60...82	100	200	250	1	0.365
RFA110095	70...95	100	200	350	1	0.365
RFA110110	90...110	125	200	350	1	0.365

NOTE: two pole (single phase) versions are available on request.
Add the letter "S" in the order code e.g. RF828200 is three pole; RFS828200 two pole.

The appropriate adjustment range of the overload relay should be selected on the basis of the motor nameplate full-load current when direct, across the line starting is considered.

[Ⓜ] For BF150 contactor used at current higher than 110A, use RF200 thermal overload relay (independent mounting).

Three-phase IEC motor powers

230V [kW]	400V [kW]	500V [kW]	690V [kW]
-----------	-----------	-----------	-----------

5.5-7.5	11-15	15-18.5	18.5-22
11	15-18.5	18.5-22	30-37
11	22	30	37-45
15-18.5	22-30	37-45	45-55
18.5-22	37-45	45-55	75
22	45	55	75-90

18.5-22	37-45	45-55	75
22	45	55	75-90
30	55	75	90

5.5-7.5	11-15	15-18.5	18.5-22
11	15-18.5	18.5-22	30-37
11	22	30	37-45
15-18.5	22-30	37-45	45-55
18.5-22	37-45	45-55	75
22	45	55	75-90

18.5-22	37-45	45-55	75
22	45	55	75-90
30	55	75	90

[Ⓜ] The indicated powers apply to 4-pole motors; it is advisable to always check that the nameplate motor current is within the relay adjustment range

Certifications and compliance

Certifications obtained:

Type	cULus	CSA	EAC	Register of shipping LROS
RF82	●	—	●	—
RFA82	●	—	●	—
RF110	●	—	—	—
RFA110	●	—	—	—

● Certified products.

cULus – UL Listed for USA and Canada (cULus - File E93601) as Auxiliary Devices – Thermal Overload Relays, 600VAC, open type, ambient compensated, 5000 Amps RMS symmetrical short circuit rating up to 82A FLA range and 10000 Amps RMS for 95A and 110A FLA range; the trip current is 120% FLA.

CSA – CSA certified for Canada only (File 54332) as Auxiliary Devices for use with magnetic contactors.

Compliant with standards: IEC/EN/BS 60947-1, IEC/EN/BS 60947-4-1, UL 60947-1, UL 60947-4-1, CSA C22.2 n° 60947-1, CSA C22.2 n° 60947-4-1.

FIXING EASE OF THE THERMAL OVERLOAD RELAY

While the thermal overload relay is being linked to the contactor, its auxiliary contact fits on and connects to the coil terminal by rigid terminal. Complete relay fixing is done in a single operation, with no need of other connections (for RF...A... version characteristic not present).



3 Motor protection relays

Thermal overload relays.
For BF series contactors

**Non phase failure /
non single phase
sensitive
Three poles (three phase)**



RFN38...

Order code	Adjustment range	Protection fuses			Qty per pkg	Wt [kg]
		IEC aM [A]	gG [A]	UL RK5 [A]		

MANUAL OR AUTOMATIC RESETTING.
Direct mounting on BF09...BF38 contactors.
Independent mounting with RFX3804 base.

RFN380016	0.1...0.16	0.25	—	1	1	0.160
RFN380025	0.16...0.25	0.5	—	1	1	0.160
RFN380040	0.25...0.4	0.5	1	3	1	0.160
RFN380063	0.4...0.63	1	2	3	1	0.160
RFN380100	0.63...1	2	4	3	1	0.160
RFN380160	1...1.6	2	4	6	1	0.160
RFN380250	1.6...2.5	4	6	10	1	0.160
RFN380400	2.5...4	4	6	15	1	0.160
RFN380650	4...6.5	8	16	25	1	0.160
RFN381000	6.3...10	10	20	40	1	0.160
RFN381400	9...14	16	32	50	1	0.160
RFN381800	13...18	25	40	70	1	0.160
RFN382300	17...23	25	50	90	1	0.160
RFN382500	20...25	32	50	100	1	0.160
RFN383200	24...32	40	63	125	1	0.160
RFN383800	32...38	40	63	150	1	0.160

NOTE: the appropriate adjustment range of the overload relay should be selected on the basis of the motor nameplate full-load current when direct, across the line starting is considered.

Three-phase IEC motor powers ①

230V [kW]	400V [kW]	500V [kW]	690V [kW]
-----------	-----------	-----------	-----------

②	②	②	0.06
②	0.06	0.06-0.09	0.09-0.12
0.06	0.09	0.12	0.18
0.09	0.12-0.18	0.18	0.25
0.12	0.25	0.25-0.37	0.37-0.55
0.18-0.25	0.37-0.55	0.55-0.75	0.75
0.37	0.75	1.1	1.1-1.5
0.55-0.75	1.1-1.5	1.5-2.2	2.2-3
1.1-1.5	2.2	3	4
1.5-2.2	3-4	4-5.5	5.5-7.5
3	5.5	5.5-7.5	11
4	7.5	11	15
5.5	11	11	18.5
5.5	11	15	22
7.5	15	18.5	30
11	18.5	22	30

① The indicated powers apply to 4-pole motors; it is advisable to always check that the nameplate motor current is within the relay adjustment range.

② No standard power ratings exist; select relay according to current consumption.

Certifications and compliance

Certifications obtained:

Type	cULus	CSA	EAC	CCC
RFN38	●	—	●	●

● Certified products.

cULus – UL Listed for USA and Canada (cULus - File E93601) as Auxiliary Devices – Thermal Overload Relays, 600VAC, open type, ambient compensated, 5000 Amps RMS symmetrical short circuit rating up to 82A FLA range and 10000 Amps RMS for 95A and 110A FLA range; the trip current is 120% FLA.

CSA – CSA certified for Canada only (File 54332) as Auxiliary Devices for use with magnetic contactors.

Compliant with standards: IEC/EN/BS 60947-1, IEC/EN/BS 60947-4-1, UL 60947-1, UL 60947-4-1, CSA C22.2 n° 60947-1, CSA C22.2 n° 60947-4-1.

FIXING EASE OF THE THERMAL OVERLOAD RELAY

While the thermal overload relay is being linked to the contactor, its auxiliary contact fits on and connects to the coil terminal by rigid terminal. Complete relay fixing is done in a single operation, with no need of other connections.

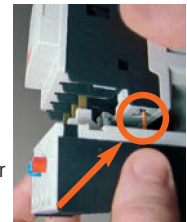

3 Motor protection relays

Thermal overload relays.
For BF series contactors

Non phase failure / non single phase sensitive Three poles (three phase)



RFN82...



RFN110...



RFNA82...



RFNA110...

Order code	Adjustment range	Protection fuses			Qty per pkg	Wt [kg]
		IEC aM	gG	UL K5		
	[A]	[A]	[A]	[A]	n°	

MANUAL RESETTING.
Direct mounting on BF40...BF94 contactors.
Independent mounting with 11G270 base.

RFN824200	28...42	50	80	150	1	0.365
RFN825000	35...50	50	100	175	1	0.365
RFN826500	46...65	80	125	200	1	0.365
RFN828200	60...82	100	200	250	1	0.365
RFN829500	70...95	100	200	250	1	0.365

MANUAL RESETTING.
Direct mounting on BF95...BF150 contactors[Ⓜ].
Independent mounting with 11G270 base.

RFN110082	60...82	100	200	250	1	0.365
RFN110095	70...95	100	200	350	1	0.365
RFN110110	90...110	125	200	350	1	0.365

AUTOMATIC RESETTING.
Direct mounting on BF40...BF94 contactors.
Independent mounting with 11G270 base.

RFNA824200	28...42	50	80	150	1	0.365
RFNA825000	35...50	50	100	175	1	0.365
RFNA826500	46...65	80	125	200	1	0.365
RFNA828200	60...82	100	200	250	1	0.365
RFNA829500	70...95	100	200	250	1	0.365

AUTOMATIC RESETTING.
Direct mounting on BF95...BF150 contactors[Ⓜ].
Independent mounting with 11G270 base.

RFNA110082	60...82	100	200	250	1	0.365
RFNA110095	70...95	100	200	350	1	0.365
RFNA110110	90...110	125	200	350	1	0.365

NOTE: the appropriate adjustment range of the overload relay should be selected on the basis of the motor nameplate full-load current when direct, across the line starting is considered.

[Ⓜ] For BF150 contactor used at current higher than 110A, use RFN200 thermal overload relay (independent mounting).

Three-phase IEC motor powers [Ⓢ]

230V [kW]	400V [kW]	500V [kW]	690V [kW]
-----------	-----------	-----------	-----------

11	15-18.5	18.5-22	30-37
11	22	30	37-45
15-18.5	22-30	37-45	45-55
18.5-22	37-45	45-55	75
22	45	55	75-90

18.5-22	37-45	45-55	75
22	45	55	75-90
30	55	75	90

11	15-18.5	18.5-22	30-37
11	22	30	37-45
15-18.5	22-30	37-45	45-55
18.5-22	37-45	45-55	75
22	45	55	75-90

18.5-22	37-45	45-55	75
22	45	55	75-90
30	55	75	90

[Ⓢ] The indicated powers apply to 4-pole motors; it is advisable to always check that the nameplate motor current is within the relay adjustment range.

Certifications and compliance

Certifications obtained:

Type	cULus	CSA	EAC
RFN82	●	—	●
RFNA82	●	—	●
RFN110	●	—	—
RFNA110	●	—	—

● Certified products.

cULus – UL Listed for USA and Canada (cULus - File E93601) as Auxiliary Devices – Thermal Overload Relays, 600VAC, open type, ambient compensated, 5000 Amps RMS symmetrical short circuit rating up to 82A FLA range and 10000 Amps RMS for 95A and 110A FLA range; the trip current is 120% FLA.
CSA – CSA certified for Canada only (File 54332) as Auxiliary Devices for use with magnetic contactors.

Compliant with standards: IEC/EN/BS 60947-1, IEC/EN/BS 60947-4-1, UL 60947-1, UL 60947-4-1, CSA C22.2 n° 60947-1, CSA C22.2 n° 60947-4-1.

FIXING EASE OF THE THERMAL OVERLOAD RELAY

While the thermal overload relay is being linked to the contactor, its auxiliary contact fits on and connects to the coil terminal by rigid terminal. Complete relay fixing is done in a single operation, with no need of other connections (for RF...A... version characteristic not present).



3 Motor protection relays

Thermal overload relays.
For BF and B series contactors



**Phase failure /
single phase sensitive
Three poles (three phase)**



RF200... - RF420...

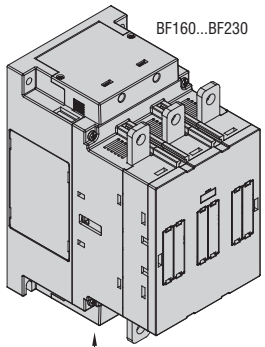

BF160...BF230

RFX20035
RFX42035

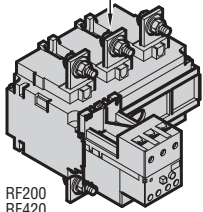

RF200
RF420

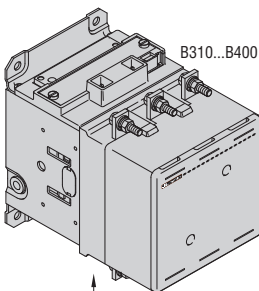

B310...B400

11G373
11G376

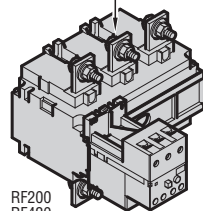

RF200
RF420

Order code	Adjustment range	Protection fuses			Qty per pkg	Wt [kg]
		IEC aM	gG [A]	UL K5 [A]		
	[A]	[A]	[A]	[A]	n°	[kg]

MANUAL OR AUTOMATIC RESETTING.
Independent screw fixing or direct mounting on contactors:
BF160-BF230 using RFX20035 links.
B310-B400 using 11G373 links.

RF200100	60...100	100	160	500	1	2.150
RF200125	75...125	125	200	500	1	2.150
RF200150	90...150	160	250	500	1	2.150
RF200200	120...200	200	315	500	1	2.150

Independent screw fixing or direct mounting on contactors:
BF195-BF230 using RFX42035 links
B310-B400 using 11G376 links

RF420250	150...250	250	400	800	1	2.460
RF420300	180...300	315	500	800	1	2.460
RF420420	250...420	500	630	800	1	2.460

NOTE: the appropriate adjustment range of the overload relay should be selected on the basis of the motor nameplate full-load current when direct, across the line starting is considered.

RELAYS FOR B500 AND B630 CONTACTORS

MANUAL OR AUTOMATIC RESETTING.
Consult Technical support for the relative order codes and detailed information; see contact details on inside front cover.

Three-phase IEC motor powers ①

230V [kW]	400V [kW]	550V [kW]	690V [kW]
-----------	-----------	-----------	-----------

18.5-25	33-51	45-63	59-92
22-37	40-63	55-80	75-110
25-45	51-80	63-100	92-140
37-59	75-100	92-140	129-184

45-75	92-132	110-162	140-220
55-92	100-162	129-198	180-280
75-110	129-198	180-280	250-368

NOTE: for 1000V powers, consult Technical support for information; see contact details on inside front cover.

① The indicated powers apply to 4-pole motors; it is advisable to always check that the nameplate motor current is within the relay adjustment

Certifications and compliance

Certifications obtained:

Type	c U L u s	E A C
RF200	●	●
RF420	●	●

● Certified products.

cULus – UL Listed for USA and Canada (cULus - File E93601) as Auxiliary Devices – Thermal Overload Relays, 600VAC, open type, ambient compensated, 5000 Amps RMS symmetrical short circuit rating up to 150A FLA range, 10000 Amps RMS for 200A up to 300A FLA range and 18000 Amps for the 420A; the trip current is 120% FLA.

Compliant with standards: IEC/EN/BS 60947-1, IEC/EN/BS 60947-4-1, UL 60947-1, UL 60947-4-1, CSA C22.2 n° 60947-1, CSA C22.2 n° 60947-4-1.

3 Motor protection relays

Thermal overload relays.
For BF and B series contactors

**Non phase failure /
non single phase sensitive
Three poles (three phase)**



RFN200... - RFN420...

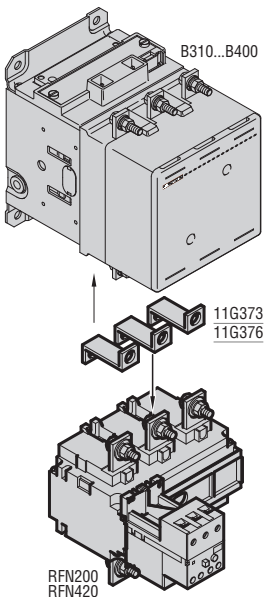
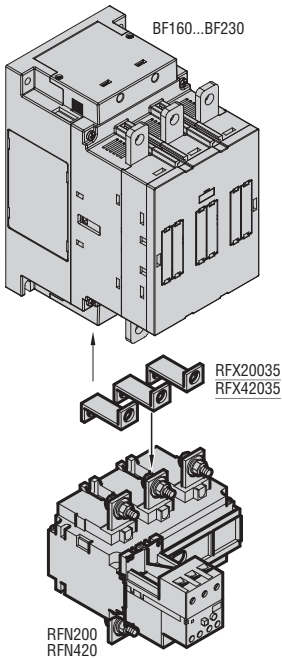

Order code	Adjustment range	Protection fuses			Qty per pkg	Wt [kg]
		IEC aM [A]	gG [A]	UL K5 [A]		
	[A]	[A]	[A]	[A]	n°	[kg]

MANUAL OR AUTOMATIC RESETTING.

Independent screw fixing or direct mounting on contactors:
BF160-BF230 using RFX20035 links.
B310-B400 using 11G373 links.

RFN200100	60...100	100	160	500	1	2.150
RFN200125	75...125	125	200	500	1	2.150
RFN200150	90...150	160	250	500	1	2.150
RFN200200	120...200	200	315	500	1	2.150

Independent screw fixing or direct mounting on contactors:
BF195-BF230 using RFX42035 links.
B310-B400 using 11G376 links.

RFN420250	150...250	250	400	800	1	2.460
RFN420300	180...300	315	500	800	1	2.460
RFN420420	250...420	500	630	800	1	2.460

NOTE: the appropriate adjustment range of the overload relay should be selected on the basis of the motor nameplate full-load current when direct, across the line starting is considered.

RELAYS FOR B500 AND B630 CONTACTORS.

MANUAL OR AUTOMATIC RESETTING.
Consult Technical support for the relative order codes and detailed information; see contact details on inside front cover.

Three-phase IEC motor powers

230V [kW]	400V [kW]	550V [kW]	690V [kW]
-----------	-----------	-----------	-----------

18.5-25	33-51	45-63	59-92
22-37	40-63	55-80	75-110
25-45	51-80	63-100	92-140
37-59	75-100	92-140	129-184

45-75	92-132	110-162	140-220
55-92	100-162	129-198	180-280
75-110	129-198	180-280	250-368

NOTE: for 1000V powers, consult Technical support for information; see contact details on inside front cover.

● The indicated powers apply to 4-pole motors; it is advisable to always check that the nameplate motor current is within the relay adjustment range.

Certifications and compliance

Certifications obtained:

Type	cULus	EAC
RFN200	●	●
RFN420	●	●

● Certified products.

cULus – UL Listed for USA and Canada (cULus - File E93601) as Auxiliary Devices – Thermal Overload Relays, 600VAC, open type, ambient compensated, 5000 Amps RMS symmetrical short circuit rating up to 150A FLA range, 10000 Amps RMS for 200A up to 300A FLA range and 18000 Amps for the 420A; the trip current is 120% FLA.

Compliant with standards: IEC/EN/BS 60947-1, IEC/EN/BS 60947-4-1, UL 60947-1, UL 60947-4-1, CSA C22.2 n° 60947-1, CSA C22.2 n° 60947-4-1.

3 Motor protection relays

Add-on blocks and accessories for thermal overload relays



RFX20035



RFX3802



RFX3803



11G363



RFX3804



11G228

Order code	For relay	Qty per pkg	Wt
		n°	[kg]

Set of links for direct contactor mounting.

RFX20035	RF...200 on contactor	BF160-BF230	1	0.250
11G373		B250-B310-B400	1	0.360
RFX42035	RF...420 on contactor	BF195-BF230	1	0.313
11G376		B250-B310-B400	1	0.500

Protection cover for thermal overload relay-contactor assembly.

RFX3802	RF38 on contactor BF09-BF12-BF18-BF25		10	0.014
RFX3803	RF38 on contactor BF26-BF32-BF38		10	0.014

Protection shrouds for power terminals.

11G361	RF...200		6	0.026
11G363	RF...420		6	0.046

Independent mounting.

Screw fixing or 35mm DIN rail (IEC/EN/BS 60715) mounting.

RFX3804	RF...38		5	0.082
11G270	RF...82 - RF...110		10	0.148

Electrical reset.

11G228	RF...9 - RF...82 - RF...110		5	0.072
--------	-----------------------------	--	---	-------

Sealing device.

RFX3801	RF...38 - RF...200 - RF...420		10	0.002
11G233	RF...9 - RF...82 - RF...110		1	0.006

- ① Code for a single terminal.
To protect all thermal overload relay terminals order 6 pcs.
N.B. The terminals equipped with the links for direct contactor mounting 11G37... don't accept the protection.
- ② Replace with voltage digit.
Standard voltages are:
- AC 50/60Hz - 24V / 48V / 110-125V / 220-240V / 380-415V.

Operational characteristics

ELECTRICAL RESET 11G228

Control circuit voltage	AC (50/60Hz)	V	12...550
Power consumption in AC		VA	300
Minimum reset time		ms	20
Terminals		Faston	6.3x0.8

NOTE: coils can remain supplied for a maximum interval of 500ms; 3 consecutive operations are allowed, followed by a 5 minute interval. Reset only if at least 1min has passed from overload tripping.

It is recommended to use the wiring diagram on page 3-14.

INDEPENDENT MOUNTING

- Conductor cross section with one cable:

- 6...10mm² / AWG 8 for RFX3804
- 35mm² / AWG 2 for 11G270

- Tightening torque:

- 2...2.5Nm / 18...22lb.in for RFX3804
- 3.9Nm / 34lb.in for 11G270.

Certifications and compliance

Certifications obtained:

Type	cULus	CSA	EAC
G361-G363	—	●	●
G373-G376-RFX20035-RFX42035	—	—	—
11G270	●	—	●
RFX3804	●	—	●

● Certified products.

cULus – UL Listed for USA and Canada (cULus - File E93601) as Auxiliary Devices for thermal overload relays.

CSA – CSA certified for Canada only (File 54332) as Kits for industrial control equipment.

Compliant with standards: IEC/EN/BS 60947-1, IEC/EN/BS 60947-4-1, UL 60947-1, UL 60947-4-1, CSA C22.2 n° 60947-1, CSA C22.2 n° 60947-4-1.

Combinations

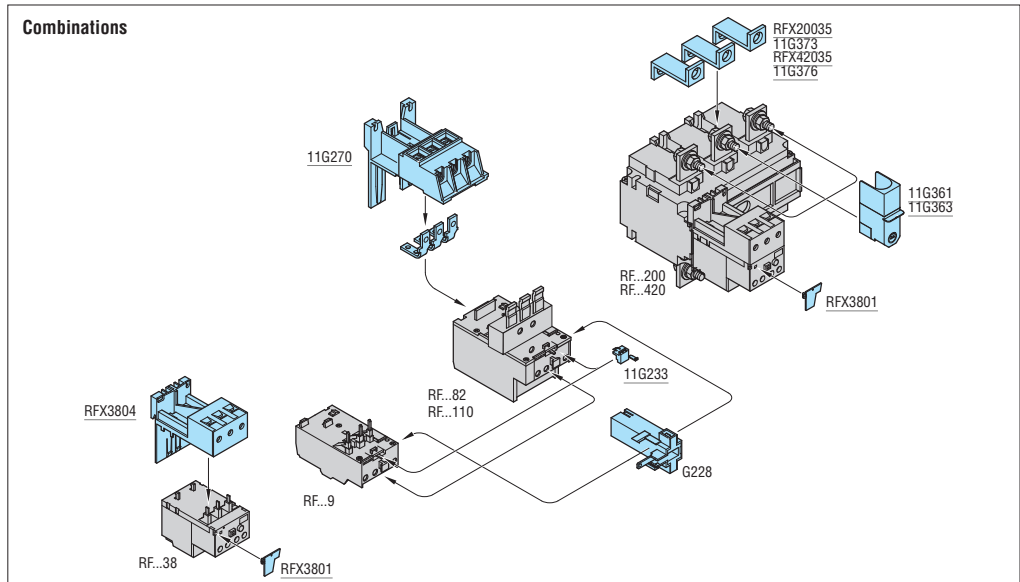

Protection cover for thermal overload relay-contactor assembly

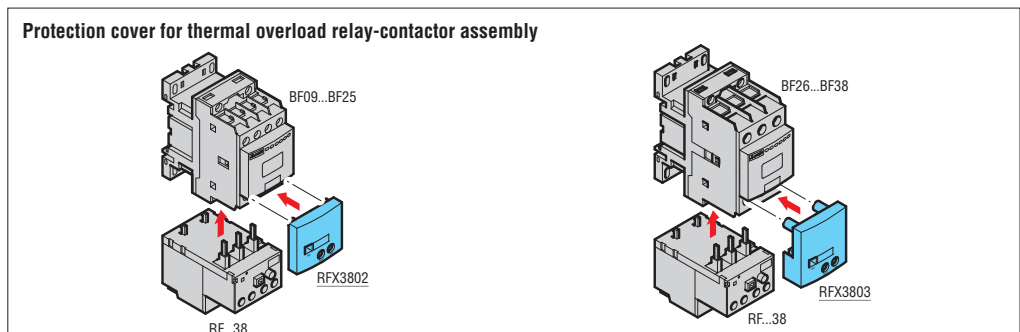

3 Motor protection relays

Electronic thermal overload relays.
For BF series contactors

**Phase failure /
single phase sensitive
Three poles (three phase)**



RFE45...

Order code	Adjustment range	Protection fuses			Qty per pkg	Wt [kg]
		IEC aM	gG	UL Class T		
	[A]	[A]	[A]	[A]	n°	
MANUAL OR AUTOMATIC RESETTING. Direct mounting on BF09...BF38 contactors. Independent mounting with RFX3804.						
RFE450200	0.4...2	4	6	125	1	0.195
RFE450800	1.6...8	10	20	125	1	0.195
RFE453200	6.4...32	40	63	125	1	0.195
RFE454500	9...45	50	63	125	1	0.195

Three-phase IEC motor powers ①

230V [kW]	400V [kW]	500V [kW]	690V [kW]
0.09...0.37	0.12...0.75	0.18...0.75	0.25...1.1
0.37...0.55	0.75...3	1.1...4	1.1...5.5
1.5...7.5	3...15	6.8...28	5.5...30
3...11	4...22	5.5...30	7.5...45

① The indicated powers apply to 4-pole motors; it is advisable to always check that the nameplate motor current is within the relay adjustment range.

General characteristics

The RFE... electronic thermal overload relays for BF series contactors are characterized by a wide current adjustment range and high reliability and accuracy of tripping. They are self powered by the main circuit current and therefore do not require separate auxiliary supply voltage. RFE electronic thermal overload relays are suitable for all types of motor starting thanks to the possibility to select several tripping classes. A single front push button is used to select the reset function, manual or automatic, and to activate or deactivate the STOP function.

Operational characteristics

- IEC power circuit rated insulation voltage U_i : 690V
- IEC auxiliary circuit rated insulation voltage U_i : 690V
- rated impulse withstand voltage: 8kV
- rated frequency: 50/60Hz
- maximum rated current: 45A
- heat dissipation per phase: <1W
- selectable tripping classes: 5-10-20-30
- phase failure sensitive
- mounting position: any
- sealable current adjuster and dip switches for tripping class selection
- degree of protection: IP20 on front.

Certifications and compliance

Certifications obtained: cULus.
Compliant with standards: IEC/EN/BS 60947-1;
IEC/EN/BS 60947-4-1, UL 60947-1, UL 60947-4-1,
CSA C22.2 n° 60947-1, CSA C22.2 n° 60947-4-1.

Thermistor protection relays



31DRPT...

Order code	Rated auxiliary supply voltage	Qty per pkg	Wt.
	[V]	n°	[kg]
DC supply (version for 35mm DIN rail IEC/EN/BS 60715).			
31DRPTC24	24VDC ^❶	1	0.269
AC supply (version for 35mm DIN rail IEC/EN/BS 60715).			
31DRPT24	24VAC	1	0.269
31DRPT110	110VAC	1	0.269
31DRPT220	220...240VAC	1	0.269
Accessories.			
Order code	Description	Qty per pkg	Wt.
		n°	[kg]
31CE106	Adapter for screw fixing of DRPT relay on mounting plate.	10	0.008

❶ Galvanic isolation between supply and measuring circuits does not exist.

General characteristics

The DRPT is a thermal protection relay for motors equipped with thermistor PTC sensors immersed in the winding heads. The maximum number of thermistors to be used is limited by the resistance of all the sensors connected in series; total ohmic value is not to exceed 1.5kΩ at 25°C.

The DRPT type has fail-safe operation: the protective feature trips even in the case the PTC circuit is disconnected or there is a lack of voltage.

Resetting is manual or automatic.

Operational characteristics

- Supply circuit:
 - Rated frequency: 50-60Hz for AC types only
 - Operational limits: 0.85...1.1 Us
 - Maximum dissipation: 2.5W
 - Connection: permanent
- Measuring circuit:
 - Type of connectable PTC sensor: According to DIN 44081
 - Total PTC resistance at 25°C: ≤1.5kΩ
 - Tripping resistance: 2.7...3.1kΩ
 - Resetting resistance: 1.5...1.8kΩ
 - Voltage at PTC terminals: ≤ 2.5VDC
- Remote resetting:
 - Control: NC contact opening
 - Contact voltage: 5VDC
 - Current consumption: about 1mA
- Relay output:
 - Arrangement: 1 relay with 2 changeover contacts
 - Rated operational voltage Ue: 250VAC
 - Conventional free air thermal current Ith: 5A
 - Designation to IEC/EN/BS 60947-5-1: B300
 - Mechanical life: 50x10⁶ cycles
 - Electrical life (with rated load): 2x10⁵ cycles
- Indications:
 - Green LED indicator for power ON
 - Red LED indicator for relay state TRIP
- Connections:
 - Conductor section 2x1.5mm² with ferrule (max)
 - Tightening torque: 0.8-1.2Nm
- Ambient conditions:
 - Operating temperature: -10...+60°C
 - Storage temperature: -30...+80°C
- Housing:
 - Snap on 35mm DIN rail (IEC/EN/BS 60715)
 - For screw fixing, use CE106 adapter
 - Degree of protection
 - IP40 housing
 - IP20 terminals.

Certifications and compliance

Certifications obtained: EAC.

Compliant with standards: IEC/EN/BS 60255-5.

3 Motor protection relays

Dimensions [mm (in)]

THERMAL OVERLOAD RELAYS DIMENSIONS WITH CONTACTORS SEE ON CHAPTER 2

ACCESSORIES FOR THERMAL OVERLOAD RELAYS

RFX3804 base c/w RF...38 thermal relay

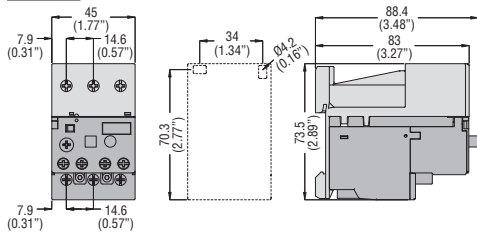

11G270 base c/w RF...82 and RF...110 thermal relay

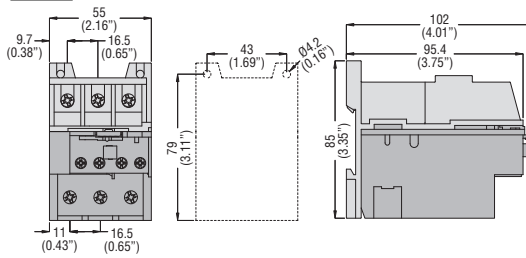

THERMAL RELAYS WITH LINKS

RF...200 with **RFX20035**, **11G372** and **11G373**

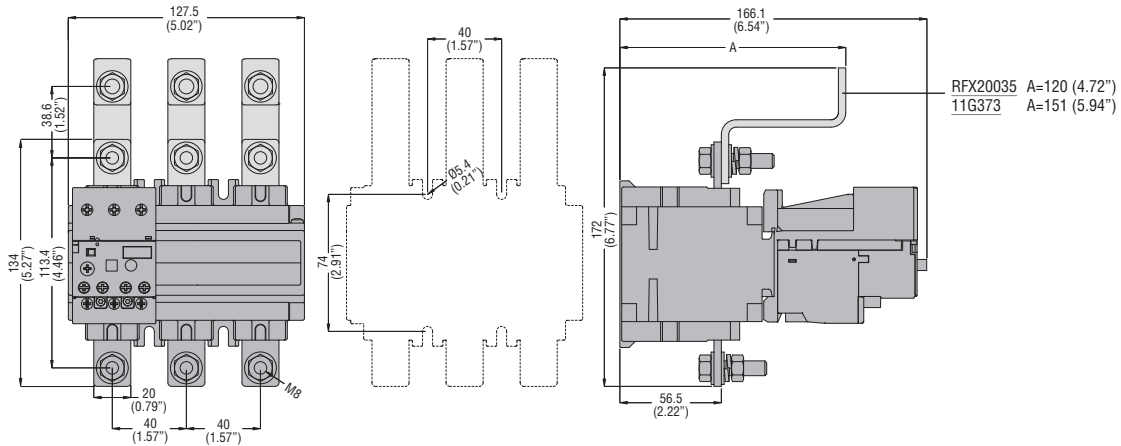

RF...420 with **RFX42035**, **11G375** and **11G376**

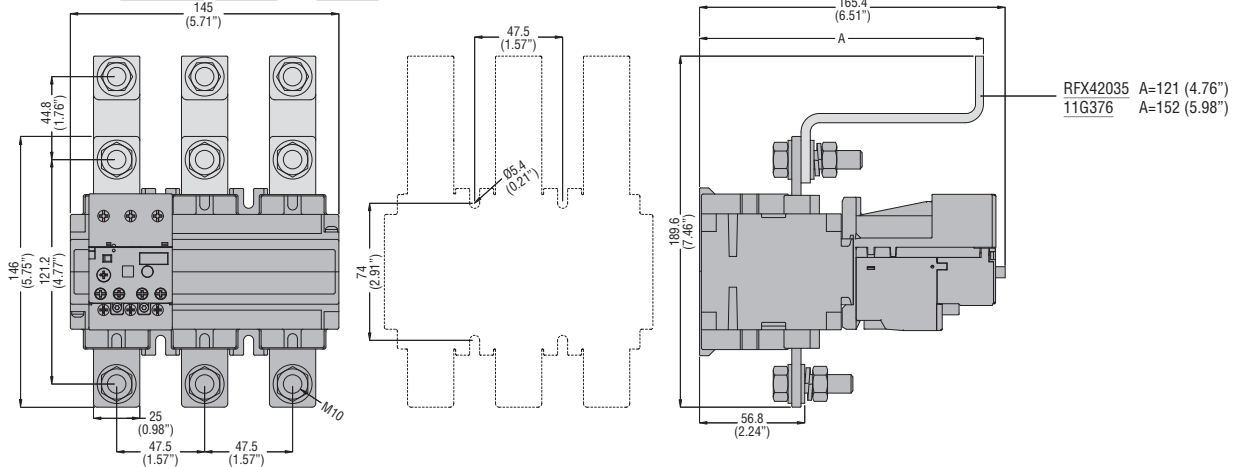

ADD-ON BLOCKS FOR THERMAL OVERLOAD RELAYS

RF...9, RF...82 and RF...110

11G228... reset

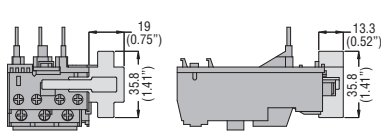

ELECTRONIC THERMAL OVERLOAD RELAYS

RFE45 with RFX3804

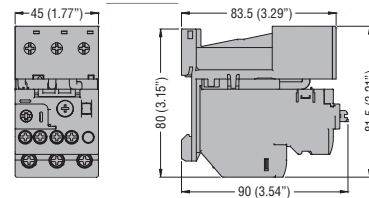

THERMISTOR PROTECTION RELAYS

DRPT

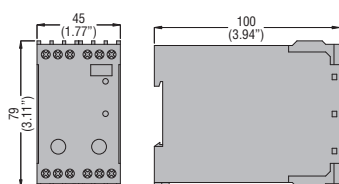

CE106 adapter

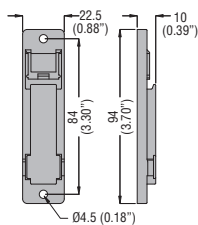

THERMAL OVERLOAD RELAYS FOR BG MINI-CONTACTORS

RF9 - RFN9

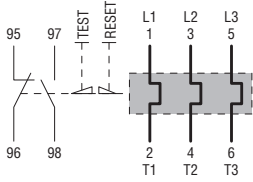

RFA9 - RFNA9

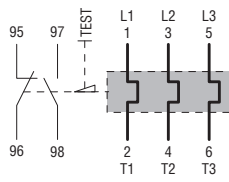

THERMAL OVERLOAD RELAYS FOR BF CONTACTORS

RF38 - RFN38

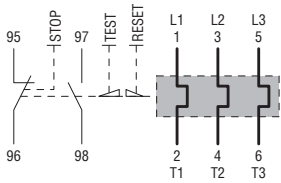

RF82 - RFN82 - RF110 - RFN110

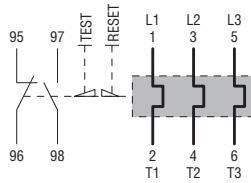

RFA82 - RFNA82 - RFA110 - RFNA110

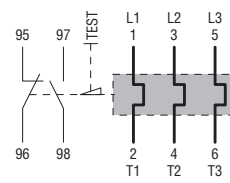

THERMAL OVERLOAD RELAYS FOR B CONTACTORS

RF200 - RFN200

RF420 - RFN420

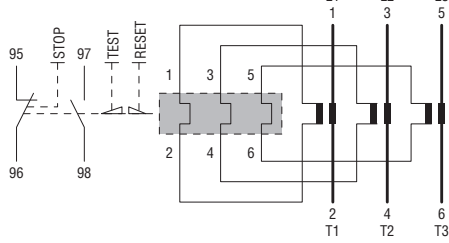

ADD-ON BLOCKS FOR THERMAL OVERLOAD RELAYS RF9 - RF82 - RF110

Electric reset 11G228

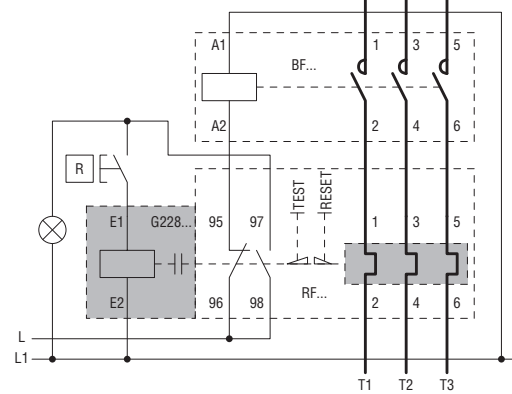

ELECTRONIC THERMAL OVERLOAD RELAYS

RFE45

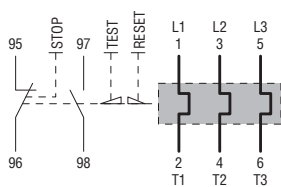

THERMISTOR PROTECTION RELAYS

DRPT

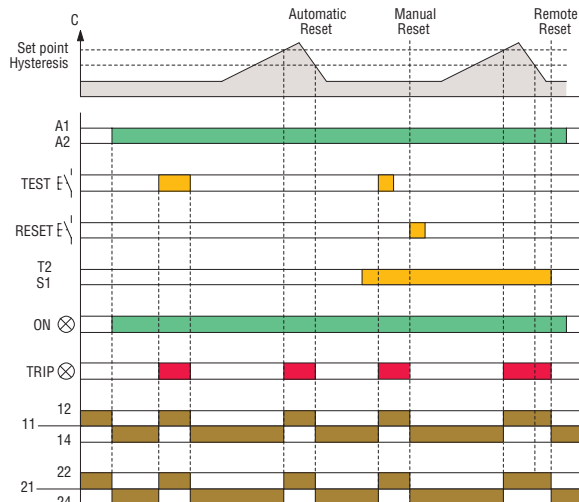
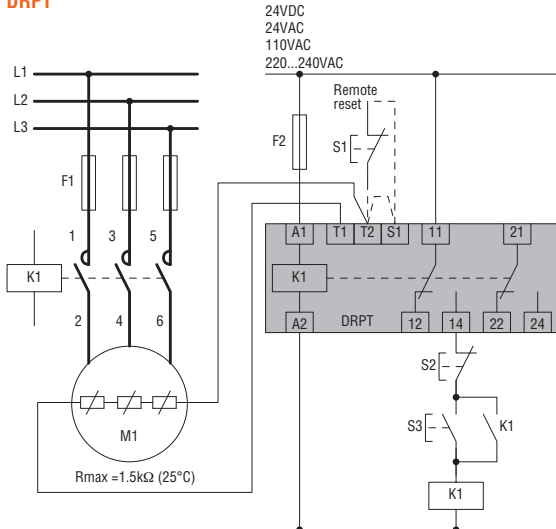

Phase failure/single phase sensitive manual reset		RF9	RF38①	RF82-RF110	RFE45	RF200①	RF420①
Phase failure sensitive automatic reset		RFA9	RFN38①	RFA82-RFA110		RFN200①	RFN420①
Non phase failure/non single phase sensitive manual reset		RFN9		RFN82-RFN110			
Non phase failure/non single phase sensitive automatic reset		RFNA9		RFNA82-RFNA110			

POWER CIRCUIT CHARACTERISTICS

IEC rated insulation voltage U_i	V	690	690	690	690	1000	1000		
IEC rated impulse withstand voltage U_{imp}	kV	8 ⑥	6	8 ⑥	6	6	6		
Frequency limit	Hz	0...400	0...400	0...400	50...60	50...60	50...60		
Operational range	from	A	0.09	0.1	20	60	0.4	60	150
	to	A	15	38	95	110	45	200	420 ②
Tripping class		10A			5-10-20-30		10A		
Particular characteristics		Test button - Trip indicator							
Connection		Direct			With current transformers ③				
Terminals	Type	Screw and washer		Yoke clamp	Screw and washer	Screw and flat washer			
	Screw	M4	M4	M5	M4	M8	M10		
	Terminal width	mm	9.8	12.6	9	12	20	25	
Tightening torque for power terminals	Phillips	n°	2	2	2	2	13mm④	18mm④	
		Nm	2.3	2...2.5	3.9	3.1	18	35	
Maximum conductor section connectable		lb.in	20	14...18	34	28	159	310	
	AWG	N°	10	8	2	6	-	-	
	Flexible w/o lug	mm²	6	10	35	16	-	-	
	Flexible c/w lug	mm²	10	6	-	10	150	2 x 150	
	Bar	mm	-	-	-	-	25 x 3	30 x 5	
Dissipation per phase	W	0.7...2.4	0.7...2.4	2.0...4.2	<1	0.7...2.4	0.7...2.4		

AUXILIARY CIRCUIT CHARACTERISTICS

Available contacts	NO	N°	1				
	NC	N°	1				
IEC rated insulation voltage	V	690					
IEC conventional free air thermal current I_{th}	A	10			5	10	
Terminals with screw and washer	Screw	M3.5					
	Terminal width	mm	8			7	8
	Phillips	n°	1	2	1	2	2
Maximum conductor section connectable	Flexible w/o lug	mm²	2.5				
	Flexible c/w lug	mm²	2.5				
Tightening torque for auxiliary terminals	Nm	1	0.8...1	1	0.8	0.8...1	0.8...1
	lb.in	8.8	9...13	8.8	9	9...13	9...13
UL/CSA and IEC/EN/BS 60947-5-1 designation		B600-P600 ⑤	B600-R300	B600-P600 ⑤	B600-R300	B600-R300	B600-R300

AMBIENT CONDITIONS

Operating temperature	°C	-20...+55	-25...+60	-20...+55	-25...+70	-25...+60	-25...+60
Storage temperature	°C	-55...+70	-50...+70	-55...+70	-55...+80	-50...+70	-50...+70
Compensation temperature	°C	-15...+55	-20...+60	-15...+55	-25...+70	-20...+60	-20...+60
Maximum altitude	m	3000					
Operation position	Normal	On vertical plane					
	Allowable	±30°					
Mounting		On contactor or separately					

- ① With manual and automatic resetting.
- ② For currents higher than 420A, consult Technical support for information; see contact details on inside front cover.
- ③ Standard supplied.
- ④ Metric wrench/spanner.
- ⑤ C600-R300 for automatic reset type.
- ⑥ 6kV for auxiliary terminals.

TRIP CHARACTERISTIC FOR RF THERMAL OVERLOAD RELAYS (AVERAGE TIME)

Three-phase balanced operation

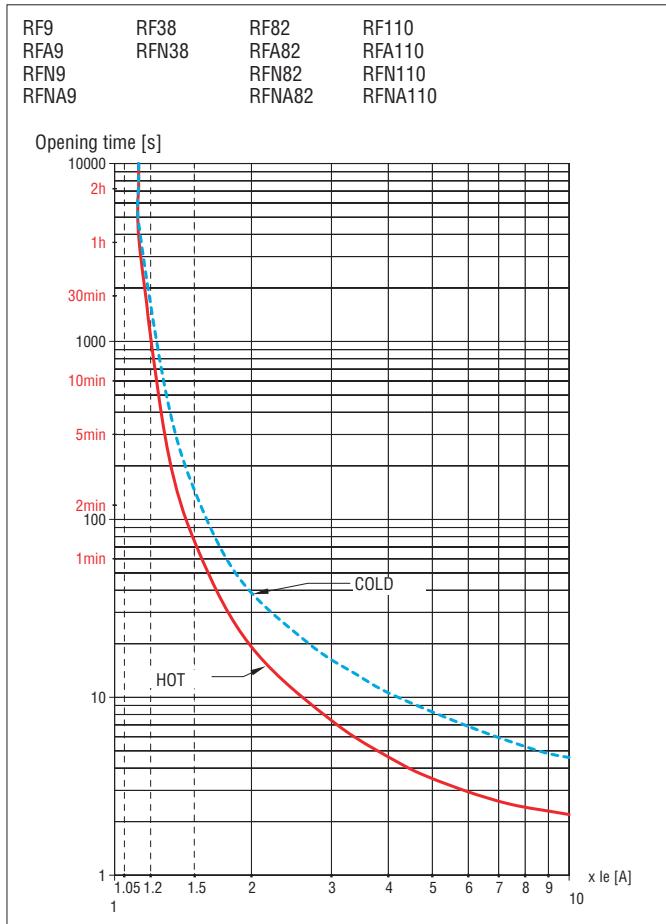

Two-phase operation (phase failure/single phase)

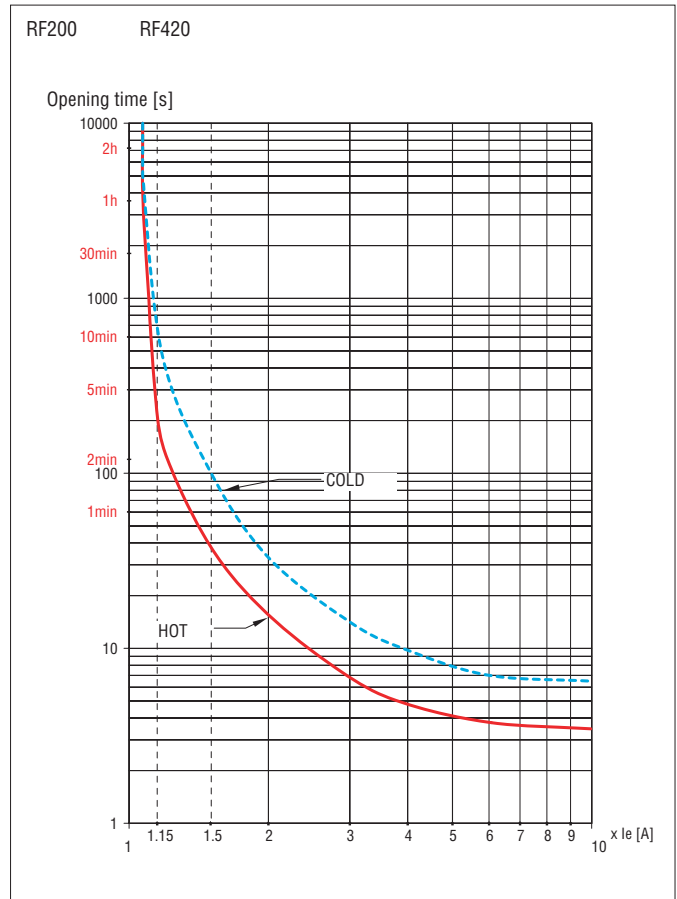
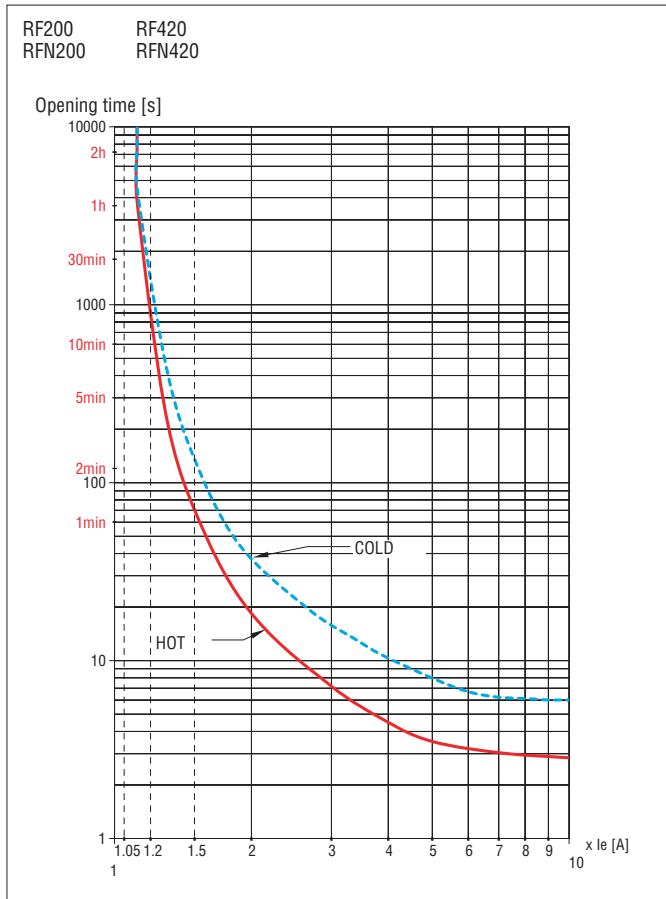
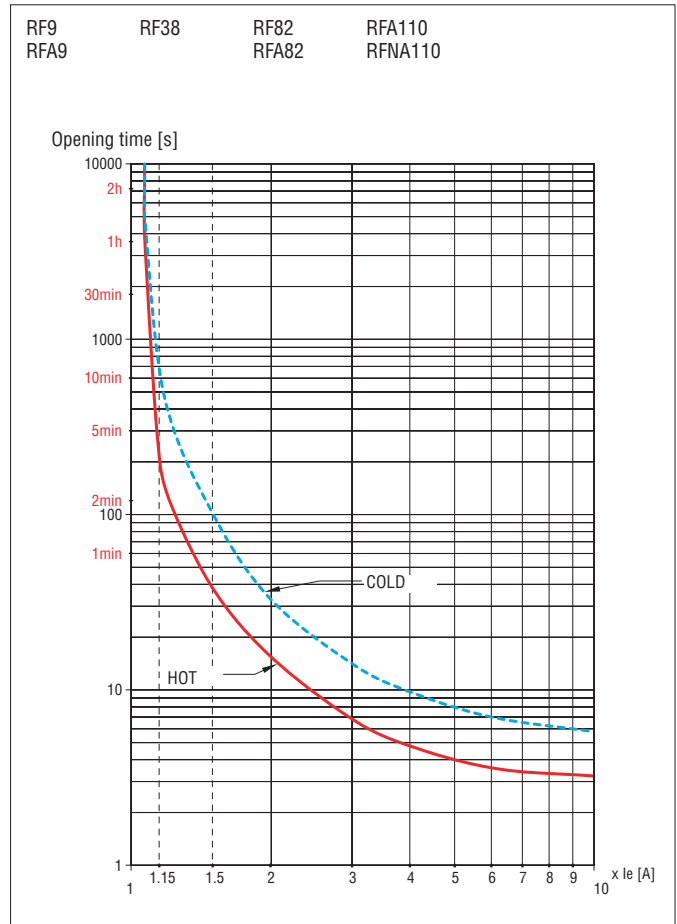

Tripping times can have a ±20% deviation with respect to the average tripping curve values above.

TRIP CHARACTERISTIC FOR RFE ELECTRONIC THERMAL OVERLOAD RELAYS
Three-phase balanced operation; class 5

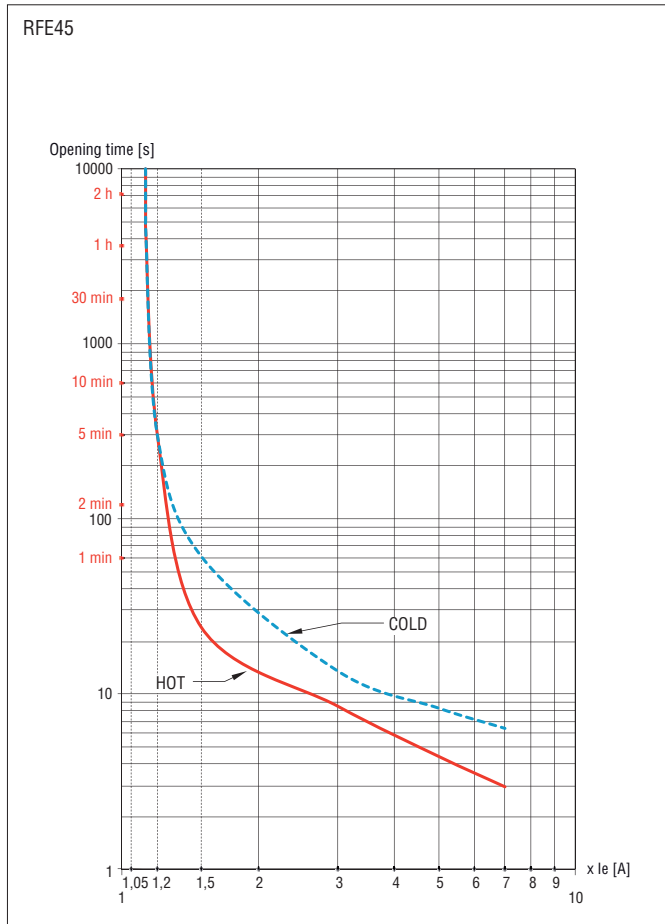

Three-phase balanced operation; class 20

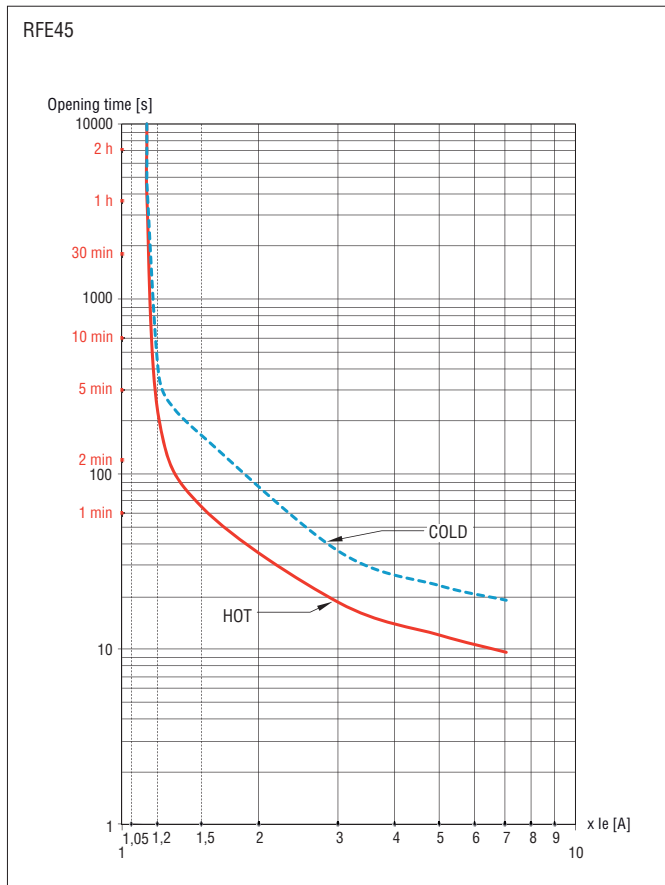

Note: with phase asymmetry >40% tripping in 3s max.

Three-phase balanced operation; class 10

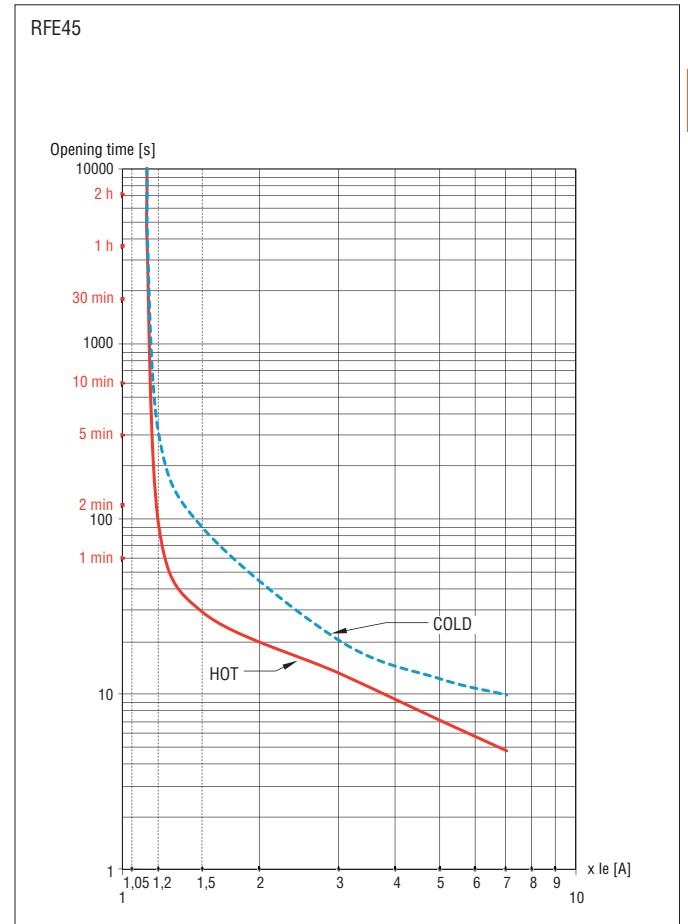

Three-phase balanced operation; class 30

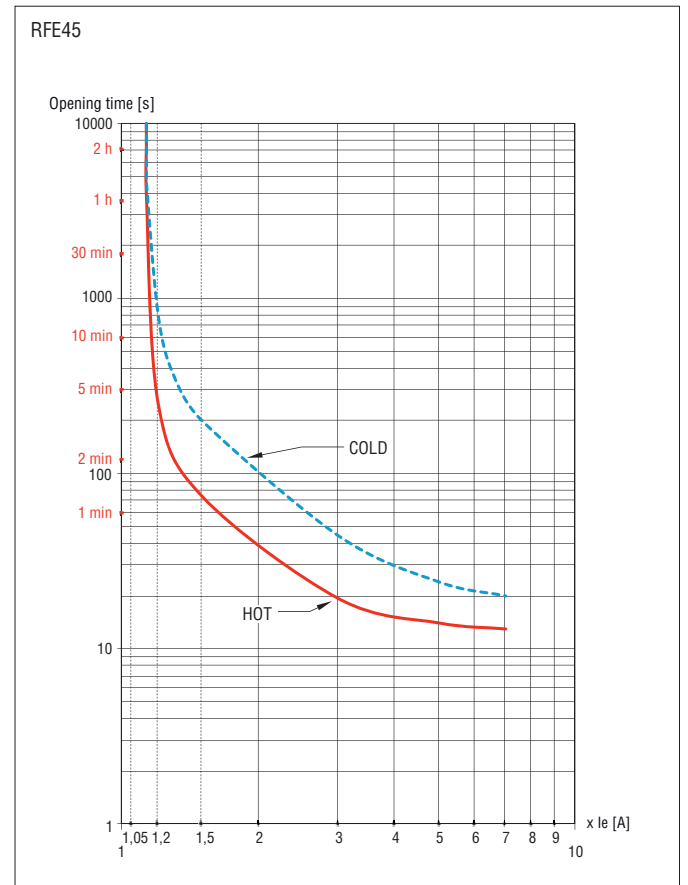



- Direct-on-line starters in non-metallic enclosure complete with or without thermal relay
- Versions with RESET or START/STOP pushbuttons
- Non-metallic enclosures for customer-assembled starters
- Reversing and changeover contactor assemblies
- Star-delta starters, open frame and in non-metallic enclosure versions.

	SEC. - PAGE
Direct-on-line starters - Full voltage across the line - Non reversing	
Enclosed with thermal relay	4 - 2
Enclosed without thermal relay	4 - 3
Enclosed with motor protection circuit breaker	4 - 4
Combinations	4 - 10
Reversing contactor assemblies	4 - 5
Changeover contactor assemblies 4 poles	4 - 5
Star-delta starters	
Open frame	4 - 6
Enclosed	4 - 7
Non-metallic enclosure for starters	4 - 7
Empty non-metallic enclosures	
Enclosures	4 - 8
Accessories and spare parts	4 - 8
Combinations	4 - 9
Dimensions	4 - 16
Wiring diagrams	4 - 21



Page 4-2

DIRECT-ON-LINE STARTERS

- Motor ratings up to 80A 440V in IEC AC3 duty
- Motor rating up to 52A 600V per UL/CSA
- Versions with Start-Stop/Reset buttons or Reset button
- Versions with and without thermal relay
- Versions with motor protection circuit breaker.



Page 4-5

REVERSING CONTACTOR ASSEMBLIES

- For three-phase motor control 9...25A 440V / 4...12.5kW 400V, in IEC AC3 duty and up to 15HP 600V per UL/CSA
- Versions with built-in or external mechanical interlock
- Complete with rigid connections
- PCB version 9A 440V / 4kW 400V in IEC AC3 duty; 5HP 300V per UL/CSA.



Page 4-5

CHANGEOVER CONTACTOR ASSEMBLIES

- From 20A to 165A loads at $\leq 40^{\circ}\text{C}$ in IEC AC1 duty
- For 20A general use per UL/CSA
- With built-in mechanical interlock.

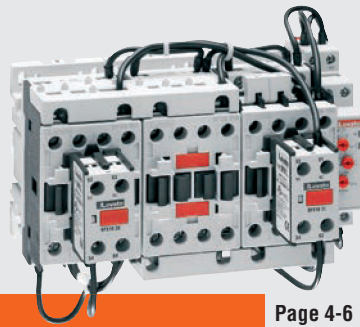

Page 4-6

STAR-DELTA STARTERS OPEN FRAME

- Suitable for three-phase motor control, 16A...225A 440V / 7.5kW...132kW 400V ratings in IEC AC3 duty.



Page 4-7

STAR-DELTA STARTERS IN NON-METALLIC ENCLOSURE

- Suitable for three-phase motor control, 16...60A 440V / 7.5kW...30kW 400V ratings in IEC AC3 duty.



Page 4-8

EMPTY NON-METALLIC ENCLOSURES

- Versions without pushbuttons, with Reset button only or Start-Stop/Reset buttons
- For starters, with pushbuttons and metal plate
- Suitable to contain BG mini-contactor or BF09A to BF80 contactors, up to 110A 440V rating in IEC AC3 duty; up to 52A at 600V for UL/CSA.

4 Electromechanical starters and enclosures

Direct-on-line starters - Full voltage across the line.
Non reversing three phase

Enclosed with thermal overload relay



MOP...12



MOR...12



M1P...12



M1R...12



M2P...12



M2R...12



M25P03812



M25R03812



M3P...12



M3R...12

Order code	Relay adj range	IEC technical characteristics (≤440V) I _e kW		Qty per pkg	Wt
	[A]	[A]	[kW]	n°	[kg]
Starters with Start and Stop/Reset pushbuttons [Ⓜ]					
M0P0091201	0.6-1	1	0.18-0.25	1	0.760
M0P0091201V5	0.9-1.5	1.5	0.37	1	0.760
M0P0091202V3	1.4-2.3	2.3	0.55-0.75	1	0.760
M0P00912033	2-3.3	3.3	1.1	1	0.760
M0P0091205	3-5	5	1.5-2.2	1	0.760
M0P00912075	4.5-7.5	7.5	2.2-3	1	0.760
M0P00912010	6-10	10	3-4	1	0.760
M0P01212015	9-15	12	5.5	1	0.760
M1P009120A4	0.63-1	1	0.25	1	1.040
M1P009120A5	1-1.6	1.6	0.37-0.55	1	1.040
M1P009120A6	1.6-2.5	2.5	0.75	1	1.040
M1P009120A7	2.5-4	4	1.1-1.5	1	1.040
M1P009120A8	4-6.5	6.5	2.2-3	1	1.040
M1P009120A9	6.3-10	10	3-4	1	1.040
M1P009120B0	9-14	13	5.5	1	1.040
M1P018120B1	13-18	18	7.5	1	1.040
M2P025120B2	17-23	23	11	1	1.220
M2P025120B3	20-25	25	11	1	1.220
M2P032120B4	24-32	32	15	1	1.300
M25P038120B5	32-38	38	18.5	1	2.880
M3P050120B6	35-50	50	18.5-22	1	3.760
M3P065120B7	46-65	65	30	1	3.760
M3P080120B8	60-82	80	37-45	1	3.760

Starters with Reset pushbuttons [Ⓜ]					
M0R0091201	0.6-1	1	0.18-0.25	1	0.720
M0R0091201V5	0.9-1.5	1.5	0.37	1	0.720
M0R0091202V3	1.4-2.3	2.3	0.55-0.75	1	0.720
M0R00912033	2-3.3	3.3	1.1	1	0.720
M0R0091205	3-5	5	1.5-2.2	1	0.720
M0R00912075	4.5-7.5	7.5	2.2-3	1	0.720
M0R00912010	6-10	10	3-4	1	0.720
M0R01212015	9-15	12	5.5	1	0.720
M1R009120A4	0.63-1	1	0.25	1	0.995
M1R009120A5	1-1.6	1.6	0.37-0.55	1	0.995
M1R009120A6	1.6-2.5	2.5	0.75	1	0.995
M1R009120A7	2.5-4	4	1.1-1.5	1	0.995
M1R009120A8	4-6.5	6.5	2.2-3	1	0.995
M1R009120A9	6.3-10	10	3-4	1	0.995
M1R009120B0	9-14	13	5.5	1	0.995
M1R018120B1	13-18	18	7.5	1	0.995
M2R025120B2	17-23	23	11	1	1.165
M2R025120B3	20-25	25	11	1	1.165
M2R032120B4	24-32	32	15	1	1.260
M25R038120B5	32-38	38	18.5	1	2.600
M3R050120B6	35-50	50	18.5-22	1	3.410
M3R065120B7	46-65	65	30	1	3.410
M3R080120B8	60-82	80	37-45	1	3.410

[Ⓜ] Complete order code with coil voltage digit (if 50/60Hz) or with voltage digit followed by 60 (if 60Hz).
Standard voltages are as follows:
- AC 50/60Hz 024 / 048 / 110 / 230 / 400V
- AC 60Hz 024 60 / 048 60 / 120 60 / 220 60 / 230 60 / 460 60 / 575 60 (V).
Example: M0R009120241 for direct-on-line starter in M0 type enclosure with Reset button, 9A/AC3 contactor with 24VAC 50/60Hz coil and 0.6-1A thermal overload relay.
M0P00912024601 for direct-on-line starter in M0 type enclosure with Start and Stop/Reset buttons, 9A /AC3 contactor with 24VAC 60Hz coil and 0.6-1A thermal overload relay.

[Ⓜ] Protection fuses are to be mounted externally by the user.

Components

Starter enclosure	Contactor	Thermal relay	Auxiliary contact block
MOPA	BG0910A	RF91	—
MOPA	BG0910A	RF91V5	—
MOPA	BG0910A	RF92V3	—
MOPA	BG0910A	RF933	—
MOPA	BG0910A	RF95	—
MOPA	BG0910A	RF975	—
MOPA	BG0910A	RF910	—
MOPA	BG1210A	RF915	—
M1PA	BF0910A	RF380100	—
M1PA	BF0910A	RF380160	—
M1PA	BF0910A	RF380250	—
M1PA	BF0910A	RF380400	—
M1PA	BF0910A	RF380650	—
M1PA	BF0910A	RF381000	—
M1PA	BF0910A	RF381400	—
M1PA	BF1810A	RF381800	—
M2PA	BF2510A	RF382300	—
M2PA	BF2510A	RF382500	—
M2PA	BF3200A	RF383200	G41810
M25PA	BF3800A	RF383800	G41810
M3PA	BF5000A	RF825000	G41810
M3PA	BF6500A	RF826500	G41810
M3PA	BF8000A	RF828200	G41810

MORA	BG0910A	RF91	—
MORA	BG0910A	RF91V5	—
MORA	BG0910A	RF92V3	—
MORA	BG0910A	RF933	—
MORA	BG0910A	RF95	—
MORA	BG0910A	RF975	—
MORA	BG0910A	RF910	—
MORA	BG1210A	RF915	—
M1RA	BF0910A	RF380100	—
M1RA	BF0910A	RF380160	—
M1RA	BF0910A	RF380250	—
M1RA	BF0910A	RF380400	—
M1RA	BF0910A	RF380650	—
M1RA	BF0910A	RF381000	—
M1RA	BF0910A	RF381400	—
M1RA	BF1810A	RF381800	—
M2RA	BF2510A	RF382300	—
M2RA	BF2510A	RF382500	—
M2RA	BF3200A	RF383200	G41810
M25RA	BF3800A	RF383800	G41810
M3RA	BF5000A	RF825000	G41810
M3RA	BF6500A	RF826500	G41810
M3RA	BF8000A	RF828200	G41810

Certifications and compliance
Refer to page 4-3 for details.

Special M3... versions
Refer to page 4-3 for details.

UL/CSA HP ratings
See page 4-24.

4 Electromechanical starters and enclosures

Direct-on-line starters - Full voltage across the line.
Non reversing three phase

Enclosed without thermal overload relay



MOP...10 MOR...10



M1P...10 M1R...10



M2P...10 M2R...10



M25P03810



M25R03810



M3P...10



M3R...10

Order code	Maximum operating current ($\leq 440V$)	Qty per pkg n°	Wt [kg]
------------	---	-------------------	------------

Starters with Start and Stop/Reset pushbuttons [Ⓜ].

M0P00910 [Ⓜ]	10	1	0.667
M0P01210 [Ⓜ]	12	1	0.667

M1P00910 [Ⓜ]	13	1	0.910
M1P01810 [Ⓜ]	18	1	0.910

M2P02510 [Ⓜ]	25	1	1.060
M2P03210 [Ⓜ]	32	1	1.162

M25P03810 [Ⓜ]	38	1	2.360
------------------------	----	---	-------

M3P05010 [Ⓜ]	50	1	3.110
M3P06510 [Ⓜ]	65	1	3.110
M3P08010 [Ⓜ]	80	1	3.110

Starters with Reset pushbutton [Ⓜ].

M0R00910 [Ⓜ]	10	1	0.627
M0R01210 [Ⓜ]	12	1	0.627

M1R00910 [Ⓜ]	13	1	0.867
M1R01810 [Ⓜ]	18	1	0.867

M2R02510 [Ⓜ]	25	1	1.020
M2R03210 [Ⓜ]	32	1	1.110

M25R03810 [Ⓜ]	38	1	2.320
------------------------	----	---	-------

M3R05010 [Ⓜ]	50	1	3.070
M3R06510 [Ⓜ]	65	1	3.070
M3R08010 [Ⓜ]	80	1	3.070

[Ⓜ] Complete order code with coil voltage digit if 50/60Hz or with voltage digit followed by 60 if 60Hz.

Standard voltages are as follows:

- AC 50/60Hz 024 / 048 / 110 / 230 / 400V
- AC 60Hz 024 60 / 048 60 / 120 60 / 220 60 / 230 60 / 460 60 / 575 60 (V).

Example: MOR009100241 for direct-on-line starter in M0 type enclosure with Reset button, 9A /AC3 contactor with 24VAC 50/60Hz coil. MOP00910024601 for direct-on-line starter in M0 type enclosure with Start and Stop/Reset buttons, 9A /AC3 contactor with 24VAC 60Hz coil.

[Ⓜ] Protection fuses are to be mounted externally by the user.

Components

Starter enclosure standard supplied	Contactor standard supplied	Thermal relay to purchase separately	Auxiliary contact standard supplied
-------------------------------------	-----------------------------	--------------------------------------	-------------------------------------

M0PA	BG0910A	RF9 [Ⓜ]	—
M0PA	BG1210A	RF9 [Ⓜ]	—

M1PA	BF0910A	RF38 [Ⓜ]	—
M1PA	BF1810A	RF38 [Ⓜ]	—

M2PA	BF2510A	RF38 [Ⓜ]	—
M2PA	BF3200A	RF38 [Ⓜ]	G41810

M25PA	BF3800A	RF38 [Ⓜ]	G41810
-------	---------	-------------------	--------

M3PA	BF5000A	RF82 [Ⓜ]	G41810
M3PA	BF6500A	RF82 [Ⓜ]	G41810
M3PA	BF8000A	RF82 [Ⓜ]	G41810

M0RA	BG0910A	RF9 [Ⓜ]	—
M0RA	BG1210A	RF9 [Ⓜ]	—

M1RA	BF0910A	RF38 [Ⓜ]	—
M1RA	BF1810A	RF38 [Ⓜ]	—

M2RA	BF2510A	RF38 [Ⓜ]	—
M2RA	BF3200A	RF38 [Ⓜ]	G41810

M25RA	BF3800A	RF38 [Ⓜ]	G41810
-------	---------	-------------------	--------

M3RA	BF5000A	RF82 [Ⓜ]	G41810
M3RA	BF6500A	RF82 [Ⓜ]	G41810
M3RA	BF8000A	RF82 [Ⓜ]	G41810

[Ⓜ] For thermal overload relay selection, refer to pages 3-2 or 3-3.

[Ⓜ] For thermal overload relay selection, refer to pages 3-4.

[Ⓜ] For thermal overload relay selection, refer to pages 3-4 or 3-5.

General characteristics

The M0..., M1..., M2..., M25... and M3...UL enclosures are made in UV protected polycarbonate. They are ideal to assemble starters for stand alone motors; robust and easily customizable adding pushbuttons, selector switches, pilot lights, modular time relays, modular level controls, etc.

M3 enclosures are made in ABS plastic material: a version in polycarbonate is available by adding the UL suffix at the end of the code.

Operational characteristics

- Cable entry:
 - M0/M1... - 2 knockouts PG13.5/M20 on enclosure top and bottom
 - M2... - 2 knockouts PG13.5/M20 or PG16/M25 on enclosure top and bottom
 - M25... - 2 knockouts PG16/M25-PG29/M32 on enclosure top and bottom
 - M3... - Smooth surfaces; can be drilled by customer
- Ambient conditions:
 - Operating temperature: -25...+60°C
 - Storage temperature: -40...+70°C
- Degree of protection: IEC IP65 for all; Type 4/4X industrial control environment for M1/M2/M25... and M3... UL versions.

Special M3... versions

In addition to standard-indicated versions, cULus certified starters are available up to 52A motor control or 65A general use rating max.

Add suffix **UL** to the order code, e.g. M3P05010024**UL**.

UL/CSA HP ratings

See page 4-24.

Certifications and compliance

Certifications obtained: UL Listed for USA and Canada cULus - File E93602) and CSA certified for Canada and USA (cCSAus - File 94157) as Magnetic Motor Controllers, enclosed type, for all M0-M1-M2-M25P/R... starters and M3P/R50-65...UL types as indicated in "Special M3" above; EAC for all.

Compliant with standards: IEC/EN/BS 60947-1, IEC/EN/BS 60947-4-1, UL 60947-1, UL 60947-4-1, CSA C22.2 n° 60947-1, CSA C22.2 n° 60947-4-1.

4 Electromechanical starters and enclosures

Direct-on-line starters - Full voltage across the line.
Non reversing three phase

Enclosed with motor protection circuit breaker



M2P00911....

Order code	Thermal trip adjustment range	IEC technical characteristics ($\leq 440V$)		Qty per pkg	Wt
		I_e [A]	[kW]		
M2P009110A4	0.63-1	1	0.25	1	1.450
M2P009110A5	1-1.6	1.6	0.37-0.55	1	1.450
M2P009110A6	1.6-2.5	2.5	0.75	1	1.515
M2P009110A7	2.5-4	4	1.1-1.5	1	1.515
M2P009110A8	4-6.5	6.5	2.2-3	1	1.515
M2P009110A9	6.3-10	10	3-5	1	1.515
M2P009110B0	9-14	13	5.5	1	1.515

① Complete order code with coil voltage digit (if 50/60Hz) or with voltage digit followed by 60 (if 60Hz).

Standard voltages are as follows:

- AC 50/60Hz 024 / 048 / 110 / 230 / 400V

- AC 60Hz 024 60 / 048 60 / 120 60 / 220 60 / 230 60 / 460 60 / 575 60 (V).

Example: M2P00911400A8 for direct-on-line starter in M2 type with reset and reset/emergency button, 9A/AC3 contactor with 400VAC 50/60Hz coil and motor protection circuit breaker 4...6.5A.

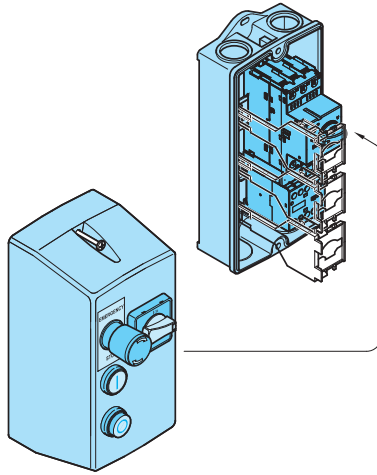

General characteristics

M2P00911... is ideal for starting applications on small machines. It is robust and fully functional for machine control: start, stop, emergency stop, overload protection, short circuit protection and disconnection (insulation function), padlockable in OFF position.

General characteristics

The M2P00911... starters are composed of an IP65 plastic enclosure where the following devices are mounted:

- a motor protection circuit breaker type SM1R... with the short circuit and overload protection function
- a contactor with start / stop function of the motor
- 2 push-buttons for the start and stop
- a mushroom push-button for the emergency stop
- a padlockable rotary actuator, that operates the circuit breaker, for the isolation, with door coupling function.

These starters are easily and quickly installed. They are especially suitable to operate the motor of smaller machines where there is no electrical panel.

Inside the enclosure, other components can be added like timers, level relays, protection relays, etc.

Operational characteristics

- M2... - 2 knockouts PG13.5/M20 or PG16/M25 on enclosure top and bottom
- Ambient conditions:
 - Operating temperature: -25...+60°C
 - Storage temperature: -40...+70°C
- Degree of protection: IEC IP65.

Certifications and compliance

Certifications obtained: EAC.

Compliant with standards: IEC/EN/BS 60947-1, IEC/EN/BS 60947-4-1.

Reversing contactor



11BGR...



BFA...



11BGT...



11BGT...

Changeover contactor assemblies 4 poles



11BGC09 ...



BFC150T4A230

new

Order code	IEC le (AC3) ≤440V ≤55°C	Max. IEC power AC3 400V at ≤55°C	Built-in auxiliary contacts	Qty per pkg	Wt
	[A]	[kW]	NO NC	n°	[kg]

AC COIL.
Terminals: clamp screw.
External interlock with power and auxiliary wiring.

11BGR0901A	9	4	0 1	1	0.394
11BGR1201A	12	5.7	0 1	1	0.394
BFA00942	9	4.2	0 1	1	0.760
BFA01242	12	5.7	0 1	1	0.760
BFA01842	18	7.5	0 1	1	0.760
BFA02542	25	12.5	0 1	1	0.760

Built-in interlock with power wiring only.

11BGT0910A	9	4	1 0	1	0.380
11BGT1210A	12	5.7	1 0	1	0.380

Rear terminals: PCB solder pins.
Built-in interlock only.

11BGTPO901A	9	4	0 1	1	0.400
-------------	---	---	-----	---	-------

DC COIL.
Terminals: clamp screw.
External interlock with power and auxiliary wiring.

11BGR0901D	9	4	0 1	1	0.460
11BGR1201D	12	5.7	0 1	1	0.460

Built-in interlock with power wiring only.

11BGT0910D	9	4	1 0	1	0.445
11BGT1210D	12	5.7	1 0	1	0.445

Rear terminals: PCB solder pins.
Built-in interlock only.

11BGTPO901D	9	4	0 1	1	0.460
-------------	---	---	-----	---	-------

Order code	IEC Operating current (AC1)			UL/CSA General Use	Qty per pkg	Wt
	≤40°C	≤55°C	≤60°C			
	[A]	[A]	[A]	[A]	n°	[kg]

AC COIL.
Terminals: clamp screw.
Built-in interlock only.

11BGC09T4A	20	18	15	20	1	0.365
------------	----	----	----	----	---	-------

AC COIL 230V 50/60HZ.
Terminals: screw.
Side mount mechanical interlock with 2NC contacts.

BFC18T4A230	32	26	23		1	0.786
BFC38T4A230	56	45	40		1	1.068
BFC80T4A230	115	95	80		1	2.532
BFC95T4A230	140	115	100		1	4.892
BFC150T4A230	165	135	118		1	4.892

DC COIL.
Terminals: clamp screw.
Built-in interlock only.

11BGC09T4D	20	18	15	20	1	0.450
------------	----	----	----	----	---	-------

- Complete order code with coil voltage digit or with voltage digit followed by 60 if 60Hz. Standard voltages are as follows:
 - AC 50/60Hz 024 / 048 / 110 / 230 / 400V
 - AC 60Hz 02460 / 04860 / 12060 / 22060 / 23060 / 46060 / 57560 (V).
 Example: 11BGR0901A024 for reversing contactor assembly with 2 mini-contactors BG09 having 1 NC auxiliary contact each and 24VAC 50/60Hz coil.
- 11BGR0901A02460 for reversing contactor assembly with 2 mini-contactors BG09 having 1 NC auxiliary contact each and 24VAC 60Hz coil.
- Complete order code with coil voltage digit. Standard voltages are:
 - DC 012 / 024 / 048 / 060 / 110 / 125 / 220V.
 Example: 11BGC09T4D012 is a changeover contactor assembly with 2 mini-contactors BG09 having 4 main poles each and 12VDC coil.
- One auxiliary contact for each contactor.
- Maximum voltage is limited to 300V for UL. For certified type up to 600V, consult Technical support; see contact details inside front cover.

General characteristics

REVERSING CONTACTOR ASSEMBLIES

Supplied complete, ready for quick mounting.

The various versions are composed as follows:

BGR... Screw termination, external mechanical interlock BGX5000, power and auxiliary wiring.

BGT... Screw termination, built-in mechanical interlock and power wiring only.

BGTP... Rear PCB solder pin termination, built-in mechanical interlock only.

No thermal overload relay can be directly mounted to BG... reversing contactor assemblies.

BFA... Screw termination, external mechanical interlock BFX5002 and power wiring.

The motor protection circuit breakers SM1... can be directly mounted to BGR... and BFA... reversing contactor assemblies by means of the rigid connections SM1X3...; for selection, refer to page 1-9.

The thermal overload relay RF38... can be directly mounted to BFA... reversing contactor assemblies; for selection, refer to section 3.

CHANGEOVER CONTACTOR ASSEMBLIES 4 POLES

Supplied complete, ready for quick mounting as follows:

11BGC... with built-in mechanical interlock, BFC... with side mounting mechanical interlock including NC contacts for electrical interlock. The changeover contactor assemblies are made with four-pole contactors.

No power or auxiliary wiring included.

Operational characteristics

Type	Maximum IEC operational power at ≤55°C (AC3)					
	230V [kW]	400V [kW]	415V [kW]	440V [kW]	500V [kW]	690V [kW]
BGR09	2.2	4	4.3	4.5	5	5
BGT09	2.2	4	4.3	4.5	5	5
BGTP09	2.2	4	4.3	4.5	5	—
BGR12	3.2	5.7	6.2	5.5	5	5
BGT12	3.2	5.7	6.2	5.5	5	5
BFA009	2.2	4.2	4.5	4.8	5.5	7.2
BFA012	3.2	5.7	6.2	6.2	7.5	10
BFA018	4	7.5	9	9	10	10
BFA025	7	12.5	13.4	13.4	15	11
at ≤40°C (AC1)						
BGC09 T4	8	14	14	15	16	22

	Maximum UL/CSA horsepower rating					
	Single phase		Three phase			
	120V [HP]	240V [HP]	208V [HP]	240V [HP]	480V [HP]	600V [HP]
BGR09	½	1½	2	3	5	5
BGT09	½	1½	2	3	5	5
BGTP09	½	1½	2	3	5	5
BGR12	½	1½	3	3	7½	10
BGT12	½	1½	3	3	7½	10
BFA009	¾	2	3	3	5	7½
BFA012	1	2	5	5	7½	10
BFA018	1	3	5	5	10	15
BFA025	2	3	7½	7½	15	15

NOTE: BGR09, BGT09, BGR12, BGT12... types are UL Listed for USA and Canada as "Magnetic Motor Controller - Reversing Contactors". All these are rated 20A general purpose use and suitable for use on a circuit capable of delivering more than 5kA symmetrical amps at 600V max when protected by fuses class K5 rated no more than 30A.

BGTP09 type is UL Recognized for USA and Canada as "Magnetic Motor Controller - Component - reversing contactors". Max HP rating up to 300VAC only; rated 20A general purpose use.

BGC... types are UL Listed for USA and Canada as "Magnetic Motor Controller - Changeover contactor".

No coil change or replacement is possible for any BG... types.

Add-on blocks

Refer to section 2, page 2-18 and page 2-20. Special add-on auxiliary contacts 11BGX1111 or 11BGX1112 must be used on the left-side contactor of the BGT reversing assemblies. For the right-side contactor, normal 11BGX10... types of auxiliary contacts can be used instead. Refer to page 2-16 for details.

Certifications and compliance

Certifications obtained: UL Listed for USA and Canada (File E93602) for BGR09, BGT09, BGR12, BGT12, BFA... and BGC... (see NOTE above), EAC.

UL Recognized, for USA and Canada (cULus - File E93602 Component), for BGTP09; products having this type of marking are intended for use as components of complete workshop-assembled equipment.

Compliant with standards UL 60947-1, UL 60947-4-1, IEC/EN/BS 60947-1, IEC/EN/BS 60947-4-1, CSA C22.2 n° 60947-1, IEC/EN/BS 60947-4-1.

Open frame

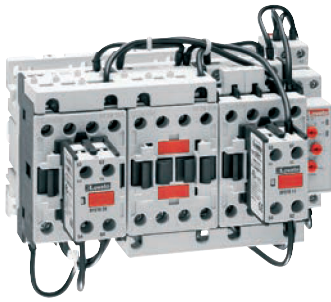

BFA009...BFA025

Order code	Three-phase motor control. Max IEC operating current ($\leq 440V$)	Thermal overload relay	Qty per pkg	Wt [kg]
	[A]			

Complete star-delta starters, open frame, for starting time up to 12s and a maximum of 30 operations/hour.

BFA0097000	16	No	1	1.700
BFA0127000	22	No	1	1.700
BFA0187000	28	No	1	1.700
BFA0257000	35	No	1	1.800
BFA0267000	43	No	1	1.800
BFA0327000	50	No	1	1.900
BFA0387000	60	No	1	1.900
BFA0507000	85	No	1	5.200
BFA0657000	110	No	1	5.200
BFA0807000	140	No	1	6.265
BFA0957000	160	No	1	6.900
BFA1157000	195	No	1	7.500
BFA1507000	225	No	1	7.500

Thermal relay adjustment range

Choose the thermal relay adjustment range considering a value equal to 58% of rated motor current (Ie).

Example: Ie=100A; 58% Ie=58A.

The suitable relay range is 46-65A.

During the setup, the relay is to be regulated at 58A.

Operational characteristics

IEC standard motor powers

230V [kW]	400V [kW]	440V [kW]	500V [kW]
-----------	-----------	-----------	-----------

4	7.5	7.5	7.5
5.5	11	11	11
7.5	15	11	11
11	18.5	18.5	22
11	22	22	25
15	25	25	25
15	30	30	30
25	45	45	59
30	55	55	75
45	75	75	90
45	90	90	110
55	110	110	132
75	132	132	160

1 Complete order code with the coil voltage digit or the coil voltage digit followed by 60 if 60Hz. Standard voltage are as follows:

- AC 50/60Hz 024 / 048 / 110 / 230 / 400V

- AC 60Hz 024 60 / 048 60 / 120 60 / 220 60 / 230 60 (V).

Example: BFA00970024 for BFA009 star-delta starter with 24VAC 50/60Hz power supply.

BFA0097002460 for BFA009 star-delta starter with 24VAC 60Hz power supply.

2 The thermal overload relay is not included and must be purchased separately. Refer to the example given under Thermal relay adjustment range, for a correct choice and then to page 3-4 for the order code.

3 TMST with auxiliary supply 24...240VAC. TMSTA440 with auxiliary supply 380...440VAC.

4 For motors with rated current >115A connect the line side with 50mm² wires crimped with pin terminals or with 2x25mm² wires connected in parallel.

5 For motors with rated current >175A connect the line side with insulated flexible copper bars or with 2x35mm² wires in parallel.

NOTE: for higher powers and voltages, or suitable for heavy-duty starting (centrifugal fans, mills, crushers) that is with starting time exceeding 12s, consult Technical support; see contact details inside front cover.

Components

Starter	Contactors			Thermal overload relay	Time relay	Auxiliary contacts fitted on contactor:			Rigid connections
	Line	Delta	Star			Line	Delta	Star	
BFA00970	BF0910A	BF0901A	BF0910A	RF38	TMST	BFX1020	—	BFX1011	BFX3131
BFA01270	BF1210A	BF1201A	BF0910A	RF38	TMST	BFX1020	—	BFX1011	BFX3131
BFA01870	BF1810A	BF1801A	BF1210A	RF38	TMST	BFX1020	—	BFX1011	BFX3131
BFA02570	BF2510A	BF2501A	BF1810A	RF38	TMST	BFX1020	—	BFX1011	BFX3131
BFA02670	BF2600A	BF2600A	BF1810A	RF38	TMST	BFX1020	BFX1011	BFX1011	BFX3232
BFA03270	BF3200A	BF3200A	BF2510A	RF38	TMST	BFX1020	BFX1011	BFX1011	BFX3232
BFA03870	BF3800A	BF3800A	BF2510A	RF38	TMST	BFX1020	BFX1011	BFX1011	BFX3232
BFA05070	BF5000A	BF5000A	BF32 00A	RF82	TMST	BFX1020	BFX1011	BFX1011	BFX3332
BFA06570	BF6500A	BF6500A	BF3200A	RF82	TMST	BFX1020	BFX1011	BFX1011	BFX3332
BFA08070	BF8000A	BF8000A	BF5000A	RF82	TMST	BFX1020	BFX1011	BFX1011	BFX3331
BFA09570	BF9500A	BF9500A	BF6500A	RF110	TMST	BFX1020	BFX1011	BFX1011	BFX3432
BFA11570	BF11500A	BF11500A	BF8000A	RF200	TMST	BFX1020	BFX1011	BFX1011	BFX3432
BFA15070	BF15000A	BF15000A	BF8000A	RF200	TMST	BFX1020	BFX1011	BFX1011	BFX3432

Certifications and compliance

Certifications obtained: EAC.

Compliant with standards: IEC/EN/BS 60947-1, IEC/EN/BS 60947-4-1.

4 Electromechanical starters and enclosures

Enclosed star-delta starters.
Non-metallic enclosure for starters

Enclosed starters



M3P...70... - M3PA70



M3P...73...

- 1 Complete order code with the coil voltage digit or the coil voltage digit followed by 60 if 60Hz. Standard voltage are as follows:
 - AC 50/60Hz 024 / 048 / 110 / 230 / 400V
 - AC 60Hz 024 60 / 048 60 / 120 60 / 220 60 / 230 60 (V).

Example: M3P00970024 for M3P009 star-delta starter with 24VAC 50/60Hz power supply.
M3P0097002460 for M3P009 star-delta starter with 24VAC 60Hz power supply.

- 2 The thermal overload relay is not included and must be purchased separately. Choose the thermal relay adjustment range considering a value equal to 58% of rated motor current (I_e).
Example: I_e=10A; 58% I_e = 5.8A. The suitable relay range is 4-6.5A, set at 5.8A, so the order code to select is RF380650).
Refer to page 3-4 for the order codes available.
- 3 Suitable for BFA...70 starters.
- 4 TMST with auxiliary supply 24...240VAC; TMSTA440 with auxiliary supply 380...400VAC.

NOTE: for higher powers and voltage ratings or suitable for heavy-duty starting (centrifugal fans, mills, crushers) that is with starting time exceeding 12s, consult Technical support; see contact details inside front cover.

Order	Three-phase motor control. Max IEC operating current (≤440V)	Qty per pkg n°	Wt [kg]
	[A]		

Star-delta starters in enclosure with Start and Stop/Reset buttons. Starting time up to 12s and a maximum of 30 operations/hour.

M3P0097002	16	1	3.540
M3P0127002	22	1	3.540
M3P0187002	28	1	3.540
M3P0257002	35	1	3.650
M3P0267002	43	1	3.650
M3P0327002	50	1	3.800
M3P0387002	60	1	3.800

With switch disconnecter, rotary door coupling handle GAX61 and Start and Stop/Reset buttons.

M3P0097302	16	1	3.700
M3P0127302	22	1	3.700
M3P0187302	28	1	3.700
M3P0257302	35	1	3.800
M3P0267302	43	1	3.800
M3P0327302	50	1	4.300
M3P0387302	60	1	4.300

Enclosure for star-delta starter, complete with Start and Stop/Reset buttons, metal plate fixed with piece of 35mm DIN (IEC/EN 60715) rail.

M3PA70 ⑥	—	1	2.240
----------	---	---	-------

Operational characteristics

IEC standard motor powers

230V [kW]	400V [kW]	440V [kW]	500V [kW]
--------------	--------------	--------------	--------------

4	7.5	7.5	7.5
5.5	11	11	11
7.5	15	11	11
11	18.5	18.5	22
11	22	22	25
15	25	25	25
15	30	30	30

- Enclosure is made in ABS plastic material
- Cable entry: smooth surface; can be drilled by customer
- Ambient conditions:
 - Operating temperature: -25...+60°C
 - Storage temperature: -40...+70°C
- Degree of protection: IEC IP65 for M3P...; UL Type 1, 12, 4/4X for M3...UL versions.

Special M3... versions

In addition to standard-indicated versions, cULus certified starters are available up to 52A motor control rating max. This is also valid for the enclosure with general use rating of 65A.

Add suffix **UL** to the order code, e.g. M3PA70UL.

Certifications and compliance

Certifications obtained: UL Listed, for USA and Canada (File E93602), as Magnetic Motor Controllers - Enclosed (starters) and - Enclosures for M3...PUL types.

Compliant with standards: IEC/EN/BS 60947-1, IEC/EN/BS 60947-4-1, UL 60947-1, UL 60947-4-1, CSA C22.2 n° 60947-1, CSA C22.2 n° 60947-4-1.

Maximum available space inside M3P...70/73 with star-delta starters BFA...70...

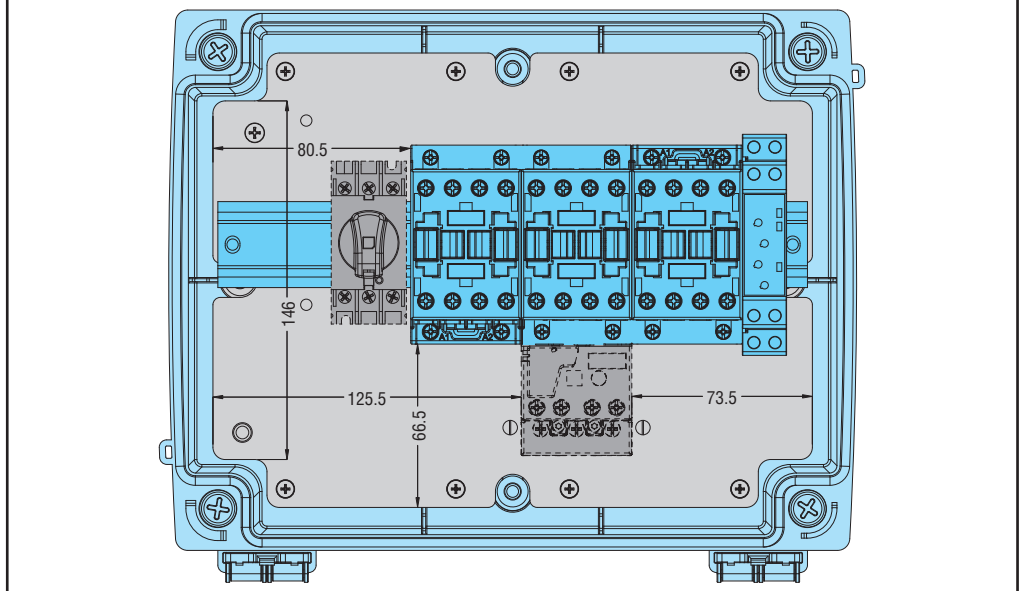

Components

Type	Enclosure	Contactors			T/o relay ②	Time relay	Auxiliary contacts fitted on contactor:			Rigid connections	Switch disconnector ⑤	Handle ⑥	Shaft ⑦
		Line	Delta	Star			Line	Delta	Star				
M3P00970/73	M3PA70	BF0910A	BF0901A	BF0910A	RF38	TMST④	BFX1020	—	BFX1011	BFX3131	GA016A	GAX61	GAX7150
M3P01270/73	M3PA70	BF1210A	BF1201A	BF0910A	RF38	TMST④	BFX1020	—	BFX1011	BFX3131	GA025A	GAX61	GAX7150
M3P01870/73	M3PA70	BF1810A	BF1801A	BF1210A	RF38	TMST④	BFX1020	—	BFX1011	BFX3131	GA032A	GAX61	GAX7150
M3P02570/73	M3PA70	BF2510A	BF2501A	BF1810A	RF38	TMST④	BFX1020	—	BFX1011	BFX3131	GA040A	GAX61	GAX7150
M3P02670/73	M3PA70	BF2600A	BF2600A	BF1810A	RF38	TMST④	BFX1020	BFX1011	BFX1011	BFX3232	GA063SA	GAX61	GAX7150
M3P03270/73	M3PA70	BF3200A	BF3200A	BF2510A	RF38	TMST④	BFX1020	BFX1011	BFX1011	BFX3232	GA063SA	GAX61	GAX7150
M3P03870/73	M3PA70	BF3800A	BF3800A	BF2510A	RF38	TMST④	BFX1020	BFX1011	BFX1011	BFX3232	GA063SA	GAX61	GAX7150

⑥ For M3P...73 types

Empty non-metallic enclosures.
Accessories and spare parts

Empty enclosures



M...PA



M...RA



M...N



M2P00911....

new

Accessories and spare parts

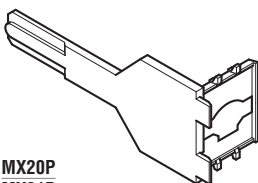

MX20P
MX21P

- ① To be purchased separately; refer to page 2-6 for contactor choice.
- ② To be purchased separately. Refer to pages 3-2 to 9 for thermal overload relay choice. For use of the overload relay in the M24N, consult Technical support; see contact details on inside front cover.
- ③ MX31 metal mounting plate included.
- ④ MX30 metal mounting plate included.
- ⑤ To install eventual pushbuttons, selectors and/or other control accessories, use the PLatinum series and mount the relay contact elements on the cover using the LPXA120 mounting adapter. See section 7.
- ⑥ SM1R motor protection circuit breaker gives the following functions: overload protection, short circuit protection and disconnection.

Order code	Contact type ①	Thermal relay ②	Degree of protect.	Qty per pkg n°	Wt [kg]
------------	-------------------	--------------------	--------------------	-------------------	------------

Enclosures with Start-Stop/Reset pushbuttons.

M0PA	BG06, BG09, BG12	RF9	IP65	1	0.490
M1PA	BF09A, BF12A, BF18A	RF38	IP65	1	0.545
M2PA	BF09A, BF12A, BF18A, BF25A, BF26A, BF32A	RF38	IP65	1	0.715
M25PA ③	BF26A, BF32A, BF38A	RF38	IP65	1	0.990
M3PA ④	BF40A, BF50A, BF65A, BF80A, BF94A	RF82, RF82	IP65	1	1.900

Enclosures with Reset pushbutton.

M0RA	BG06, BG09, BG12	RF9	IP65	1	0.445
M1RA	BF09A, BF12A, BF18A	RF38	IP65	1	0.500
M2RA	BF09A, BF12A, BF18A, BF25A, BF26A, BF32A	RF38	IP65	1	0.670
M25RA ③	BF26A, BF32A, BF38A	RF38	IP65	1	0.970
M3RA ④	BF40A, BF50A, BF65A, BF80A, BF94A	RF82, RF82	IP65	1	1.850

Enclosures without external pushbuttons.

M0N	BG06, BG09, BG12	RFA9	IP65	1	0.405
M1N	BF09A, BF12A, BF18A	RF38	IP65	1	0.460
M2N	BF09A, BF12A, BF18A, BF25A, BF26A, BF32A	RF38	IP65	1	0.640
M24N ⑤⑥	BG06...BG12, BF09A...BF25A	②	IP65	1	0.625
M25N ③	BF09A, BF12A, BF18A, BF26A, BF32A	RF38	IP65	1	0.940
M3N	BF40A, BF50A, BF65A, BF80A, BF94A	RF82, RF82	IP65	1	1.800

Enclosures with Start, Stop, Emergency stop pushbuttons and Handle to operate motor protection circuit breaker.

M2P00911	BG06, BG09, BG12	SM1R ⑥	IP65	1	0.950
-----------------	------------------	-----------	------	---	-------

Order code	Description	Qty per pkg n°	Wt [kg]
LPXA130	Threaded plug for unused holes, grey RAL7035	10	0.007
MX10P	Stop/Reset button extension rod for M0 enclosure	5	0.010
MX11P	Stop/Reset button extension rod for M1 enclosure	5	0.010
MX12P	Stop/Reset button extension rod for M2, M25 enclosures	5	0.010
MX20P	Mounting base for LPX C... contact on M0 enclosure	5	0.014
MX21P	Mounting base for LPX C... contact on M1, M2, M25 enclosures	5	0.014
MX30	Metal mounting plate for M3N	1	0.500
MX31	Metal mounting plate for M24N and M25 enclosures	1	0.400

General characteristics

The M0..., M1..., M2..., M25... and M3...UL enclosures are made in UV protected polycarbonate.
M3 enclosure is made in ABS plastic material.

Operational characteristics

Enclosure type | Maximum operating current (≤440V) [A]

M0...	12
M1...	18
M2...	32
M2P00911	13
M24N	38
M25...	38
M3...	80

General characteristics

Enclosures are supplied with the following accessories:

Accessory	Type	Type of enclosure							
		M0PA	M1PA	M2PA	M25PA	M3RA	M1RA	M2RA	M25RA
Contact holder	MX20P MX21P	1							
Buttons:	LPCB1176					1	1	1	1
- Stop/Reset	LPCB2104	1	1	1	1				
- Start	LPCB1113	1	1	1	1				
Contact for Start button	LPXC10	1	1	1	1				
Stop/Reset button extension	MX10P MX11P MX12P	1				1		1	
Unused hole threaded plug	LPXA130					1	1	1	1

- M2P00911 enclosure: Start, Stop, Emergency stop pushbuttons with contacts and Handle to operate motor protection circuit breaker
- M3PA enclosure: 2 Start and Stop/Reset pushbuttons and 1 MX30 mounting plate
- M3RA enclosure: 1 Reset pushbutton and 1 MX30 mounting plate
- M3N enclosure: supplied without accessories to be purchased separately including MX 30 mounting plate.

Enclosures can house the following devices:

- M0 = BG... with/without RF9
- M1 = BF09A-BF12A-BF18A with/without RF38
- M2 = BF25A-BF26A-BF32A, assemblies BFA...42 with/without RF38
- M2P00911 = SM1R... with BG...
- M24N = BG..., BF09A...BF25A, assemblies BGR/BGT/BGC and BFA...42 without overload
- M25 = BF26...BF38A, assemblies BGR/BGT/BGC and BFA...42 with/without overload
- M3 = BF40...BF94 and all assemblies with/without overload.

Operational characteristics:

- Cable entry:
 - M0/M1/M2... - 2 knockouts PG13.5/M20 on enclosure top and bottom
 - M24N/M25... - 2 knockouts PG16/M25-PG29/M32 on enclosure top and bottom
 - M3... - Smooth surfaces; can be drilled by customer
- Ambient conditions:
 - Operating/storage temperature: -25...+60°C/-40...+70°C
- Degree of protection: IEC IP65 for all; UL Type 1, 12, 4/4X for M0/M1/M2/M24N/M25... types and M3...UL versions.

Special M3... versions

In addition to standard-indicated versions, cULus certified starters and enclosures are available up to 52A - motor control and 65A general use rating max (MX30 plate, earth/ground and neutral terminal plates are always included in this case). Add suffix **UL** to the order code of enclosures e.g. **M3N UL**.

Certifications and compliance

Certifications obtained: EAC for all; for M3NUL type, UL Listed for USA and Canada (cULus - File E300050) as Industrial control panels; for M0/M1/M2PA/RA/N and other M3...UL types, UL Listed for USA and Canada (cULus - File E93602) under magnetic motor controllers as Polymeric enclosures - and CSA certified for Canada and USA (cCSAus - File 94157) as Non-metallic enclosures. Compliant with standards: IEC/EN/BS 60947-1, IEC/EN/BS 60947-4-1, UL 60947-1, UL 60947-4-1, CSA C22.2 n° 60947-1, CSA C22.2 n° 60947-4-1.

4 Electromechanical starters and enclosures

Empty non-metallic enclosures

M...PA EMPTY ENCLOSURES

MOPA

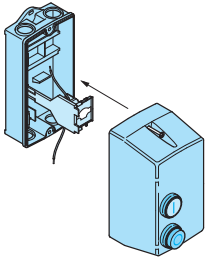

M1PA

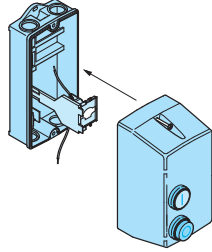

M2PA

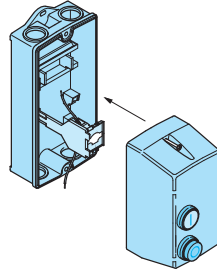

M25PA

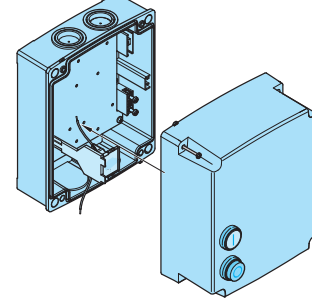

M3PA

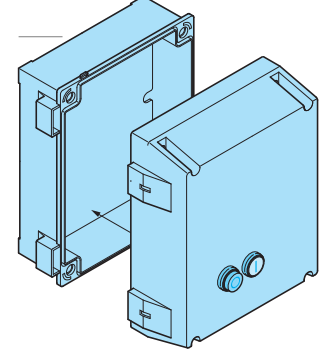

M...RA EMPTY ENCLOSURES

MORA

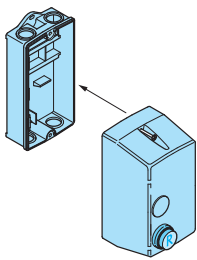

M1RA

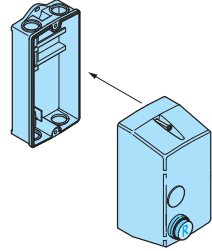

M2RA

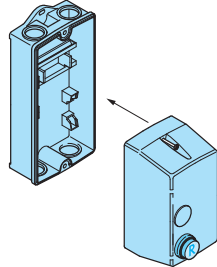

M25RA

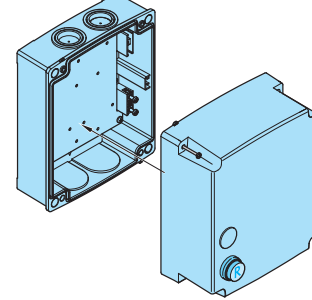

M3RA

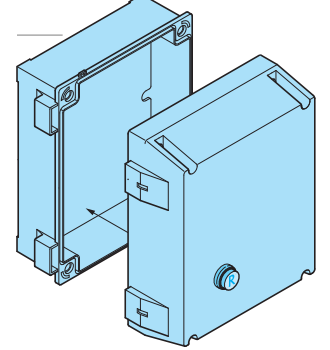

M...N EMPTY ENCLOSURES

MON

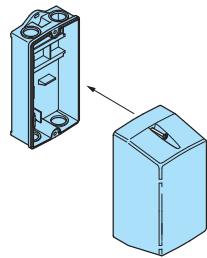

M1N

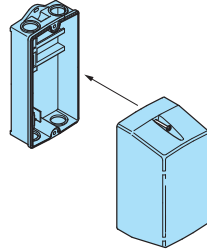

M2N

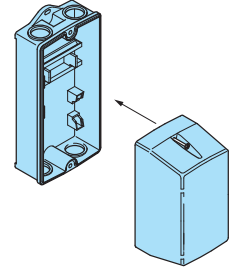

M24N

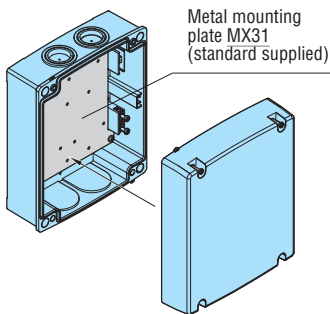

M25N

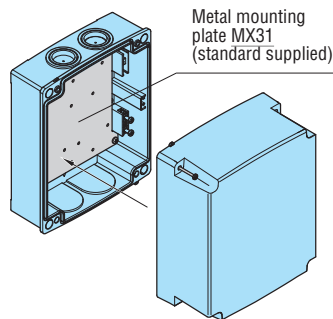

M3N

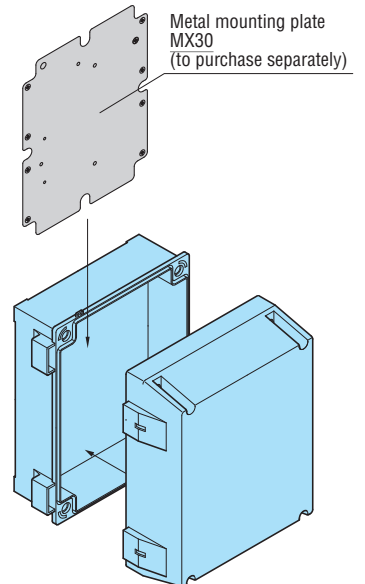

4 Electromechanical starters and enclosures

Direct-on-line starters - Full voltage across the line.
Non reversing three phase

M...P... STARTERS, ENCLOSED

MOP00912... MOP01212...
MOP00910... MOP01210...

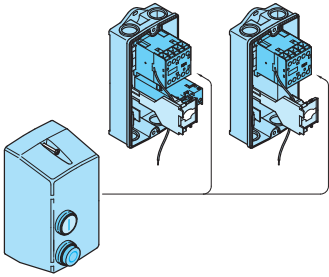

M1P00912... M1P01812...
M1P00910... M1P01810...

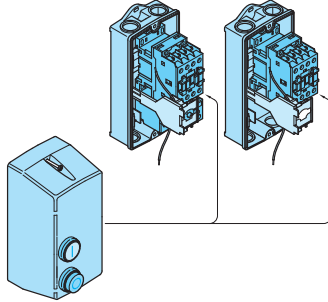

M2P02512... M2P03212...
M2P02510... M2P03210...

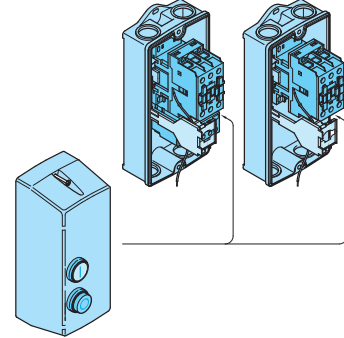

M...R... STARTERS, ENCLOSED

MOR00912... MOR01212...
MOR00910... MOR01210...

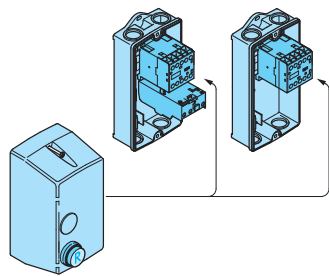

M1R00912... M1R01812...
M1R00910... M1R01810...

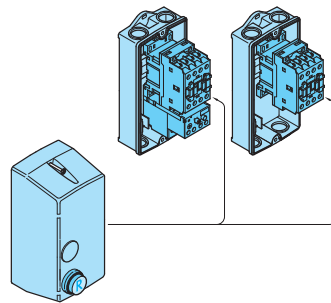

M2R02512... M2R03212...
M2R02510... M2R03210...

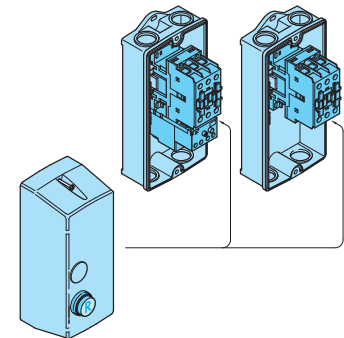

M25... STARTERS, ENCLOSED

M25P03812... M25P03810...

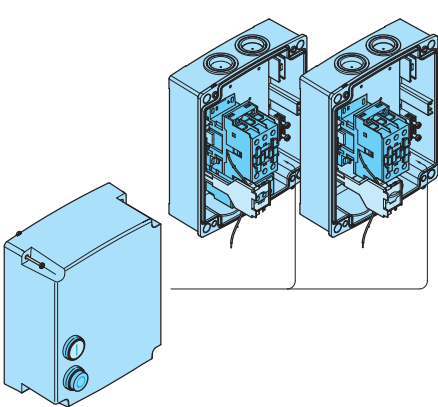

M25R03812... M25R03810...

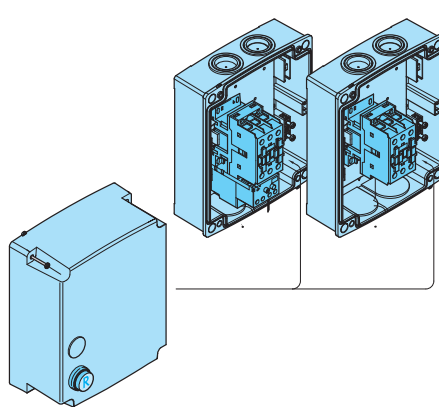

M2... STARTERS, ENCLOSED

M2P00911

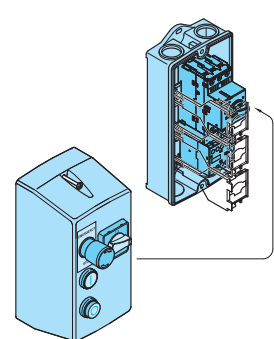

M3... STARTERS, ENCLOSED

M3P05012... to M3P09512...

M3P05010... to M3P09510...

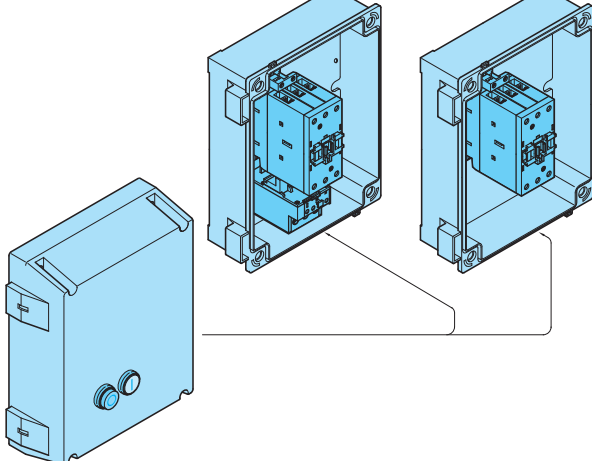

M3R05012... to M3R09512...

M3R05010... to M3R09510...

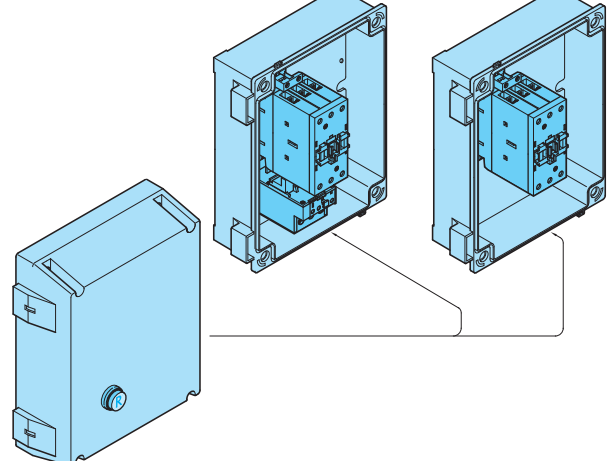

4 Electromechanical starters and enclosures

Direct-on-line starters - Full voltage across the line.
Accessories and spare parts

Maximum combinations for MO... and M1... starters in enclosure

For the fitting of add-on blocks and electronic relays in the starters, consult our Technical support; see contact details on inside front cover.

The enclosure cover can be equipped with various types of actuators and pilot lights, per following details:

1) Upper position 1

The cover must be drilled in this position, with a 22.5mm hole, by the user and LPL..., LPM... and LPCZS... pilot light can be fitted.

To fit the LPL... pilot light head, the mounting base, type MX20P for MO enclosure or type MX21P for M1 enclosure, must also be purchased. The LED element is snapped onto this mounting base.

No adapter or base is needed for LPL..., LPM... and LPCZS...

2) Middle position 2

Based on the enclosure type, in this position, the user finds either the Start button or threaded plug. Various **PLatinum** (plastic series) actuators can be fitted in this position, such as flush or extended buttons, selectors or pilot lights, as illustrated below. To fit the actuators, the mounting base, type MX20 for MO enclosure, or type MX21P for M1 enclosure, must also be purchased. The contact or LED elements are snapped onto this mounting base. No adapter or base is needed for LPL..., LPM... and LPCZS...

3) Lower position 3

The STOP/RESET button is mounted in this position, except for the enclosure without buttons. This button activates the thermal overload relay via a mechanical actuator.

In eventual applications without thermal overload relay, this button can be removed and the hole closed up by the threaded plug LPXA130.

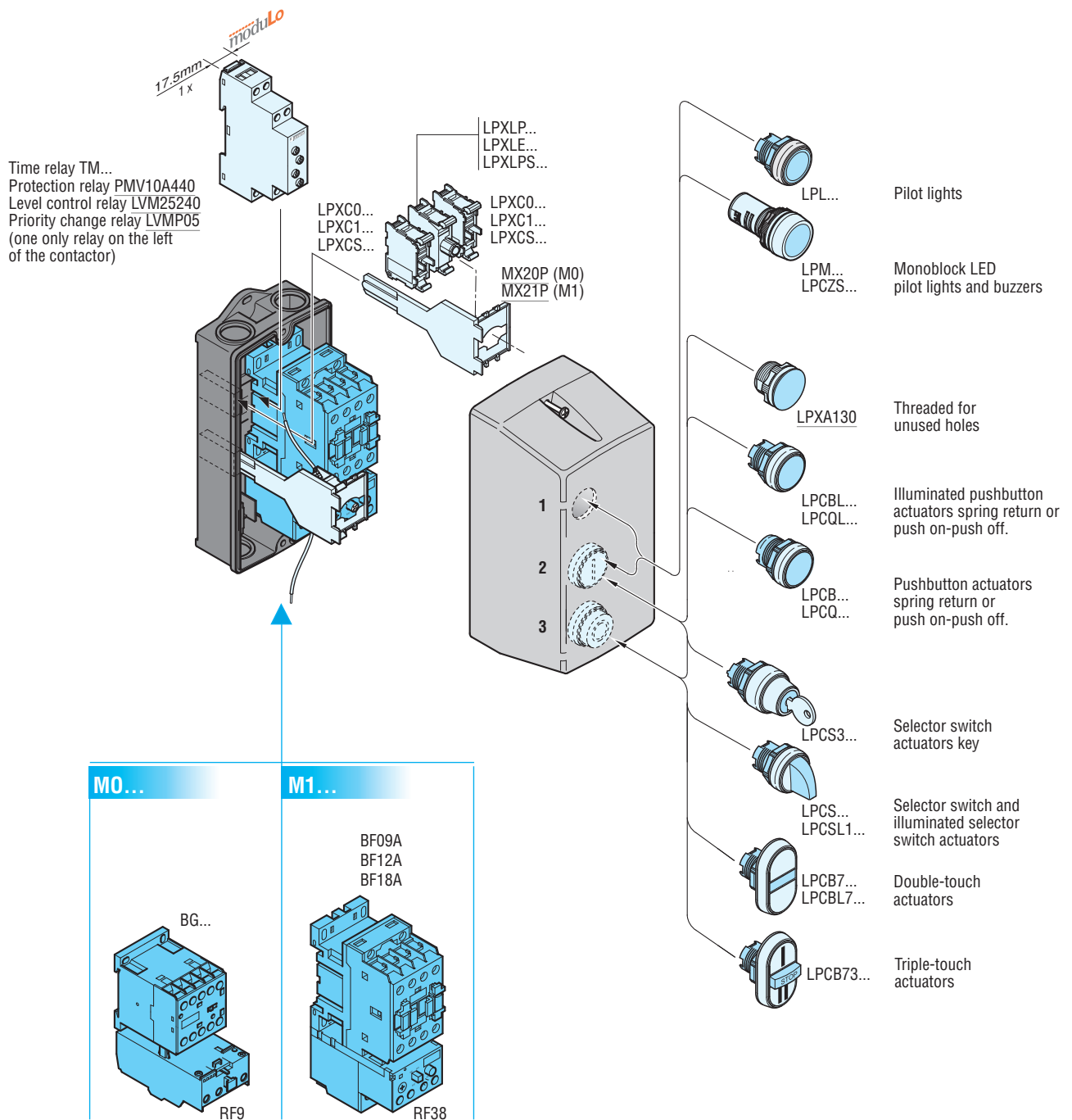

4 Electromechanical starters and enclosures

Direct-on-line starters - Full voltage across the line.
Accessories and spare parts

Maximum combinations for M2... starters in enclosure

For the fitting of add-on blocks and electronic relays in the starters, consult our Technical support; see contact details on inside front cover.

The enclosure covers can be equipped with various types of actuators and pilot lights, per following details:

1) Upper position 1

The cover must be drilled in this position with a 22.5mm hole by the user; LPL..., LPM... or LPCZS... pilot light can be fitted.

To fit the LPL... pilot light, the mounting base type MX21P must also be purchased. The LED element is snapped onto this mounting base.

No adapter or base is needed for LPL..., LPM... and LPCZS...

2) Middle position 2

Based on the enclosure type, in this position, the user finds either the Start button or threaded plug.

Various **PLatinum** (plastic series) actuators can be fitted in this position, such as flush or extended buttons, selectors or pilot lights, as illustrated in the side figure.

To fit the actuators, the mounting base type MX 21P must also be purchased.

The contact or LED elements are snapped onto this mounting base.

No adapter or base is needed for LPL..., LPM... and LPCZS...

3) Lower position 3

The STOP/RESET button is mounted in this position, except for the enclosure without buttons.

This button activates the thermal overload relay via a mechanical actuator. In eventual applications without thermal overload relay, this button can be removed and the hole closed up by the threaded plug LPXA130. Various **PLatinum** (plastic series) actuators can be fitted in this position, such as flush or extended buttons, selectors or pilot lights, as illustrated in the drawing below. To fit the actuators, the mounting base type

MX21P must also be purchased. The contact or LED elements are snapped onto this mounting base.

No adapter or base is needed for LPL..., LPM... and LPCZS...

4) Upper position 4

The cover must be drilled in this position with a 22.5mm hole by the user whenever an external handle is needed for a switch disconnector fitted in the enclosure.

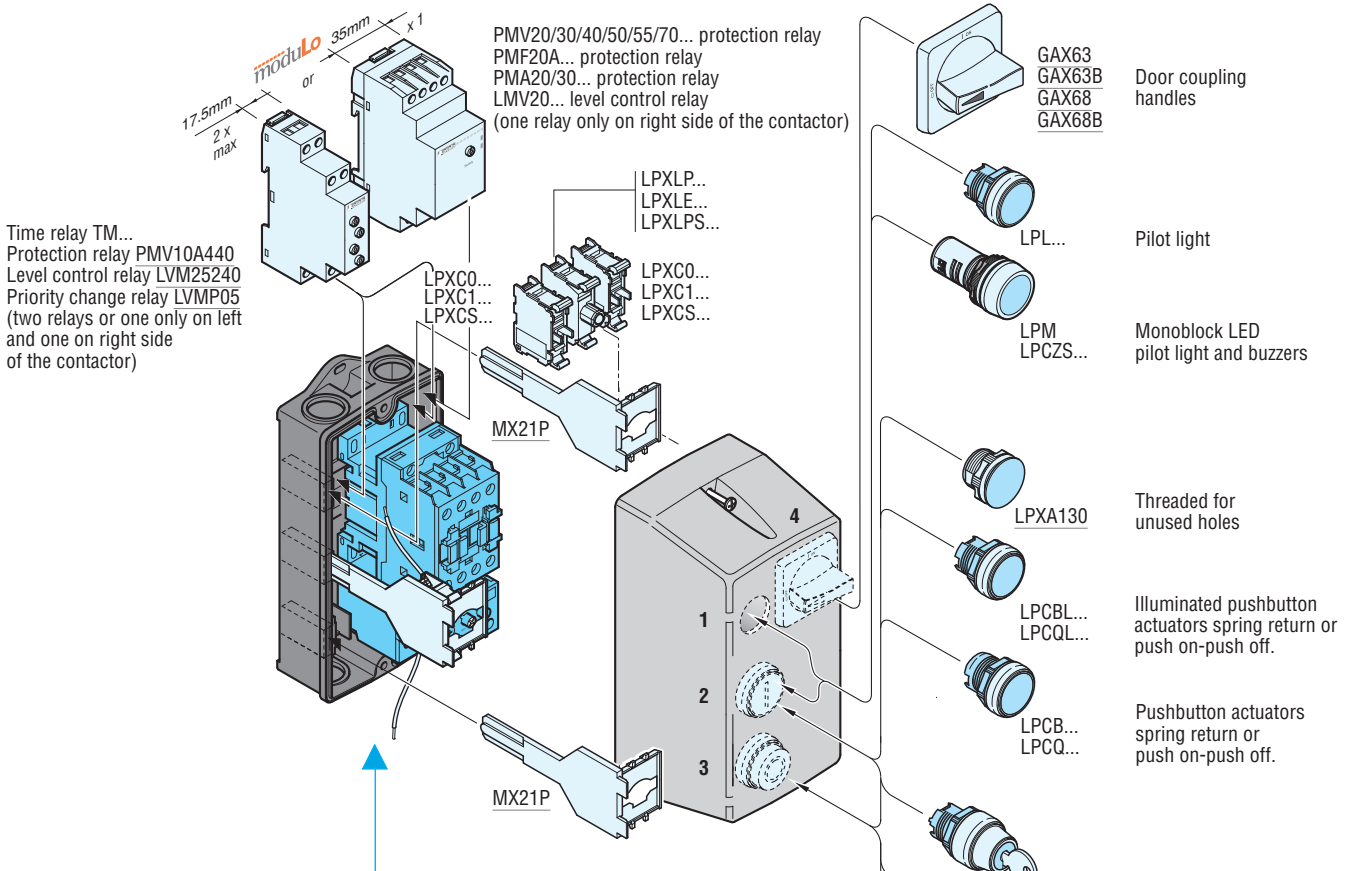

Time relay TM...
Protection relay PMV10A440
Level control relay LVM25240
Priority change relay LVMP05
(two relays or one only on left and one on right side of the contactor)

PMV20/30/40/50/55/70... protection relay
PMF20A... protection relay
PMA20/30... protection relay
LMV20... level control relay
(one relay only on right side of the contactor)

LPLXP...
LPXLE...
LPXLS...

LPXC0...
LPXC1...
LPXCS...

GAX63
GAX63B
GAX68
GAX68B
Door coupling handles

LPL... Pilot light

LPM
LPCZS... Monoblock LED pilot light and buzzers

LPA130
Threaded for unused holes

LPCBL...
LPCQL... Illuminated pushbutton actuators spring return or push-on-push off.

LPCB...
LPCQ... Pushbutton actuators spring return or push-on-push off.

LPCS3... Selector switch actuators key

LPCS...
LPCSL1... Selector switch and illuminated selector switch actuators

LPCB7...
LPCB7... Double-touch actuators

LPCB73... Triple-touch actuators

M2...

BF25A
BF26A
BF32A

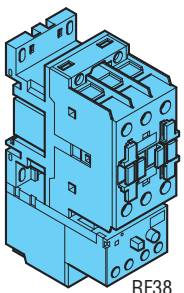

RF38

M2...

n°2 BF09A n°2 BF18A
n°2 BF12A n°2 BF25A

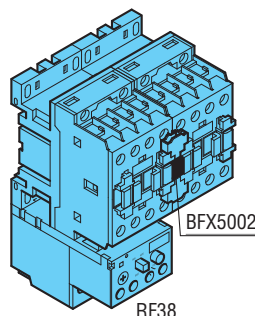

BF5002

RF38

M2...

BF09A BF25A
BF12A BF26A
BF18A BF32A

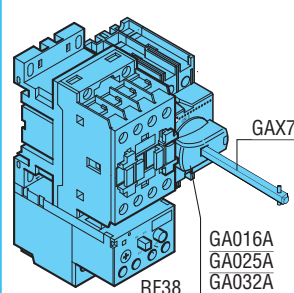

GAX7090

GA016A
GA025A
GA032A

RF38

Maximum combinations for starters in M24N enclosure

In addition to a direct-on-line, full voltage across the line, starter or reversing contactor assembly, various other electromechanical devices can be fitted. The cover of the M24N enclosure can be used across the entire surface to mount pushbuttons, measuring instruments, switch disconnectors GA016A...GA040A and GA063SA type. No contact blocks or other additional accessories can be mounted on the contactor face of AC BF series; they can only be fitted on the contactor side since the cover is shallow.

Eventually pushbuttons, selector switches and/or other control accessories of the PLatinum (plastic series) can be used and contact or LED elements can be mounted directly inside on the cover with the LPXAU120 mounting adapter; refer to section 7.

MX31 internal metal mounting plate is standard-supplied.

The wall fixing holes and the cover closing captive screws are positioned **outwards** with respect to the sealing gasket. This guarantees the protection degree of the enclosure against infiltrations liquid (IEC IPX5 / UL Type 4X).

The base has **ribbing** which facilitates the fixing of DIN rails, metal mounting plates and electronic printed boards.

Grid references, marked by letters and numbers, are engraved on the interior surface of the cover. This grid allows to quickly identify the exact drilling points where pushbuttons, handles or pilot lights will be mounted.

A **safety sealing** system keeps the cover and base together to avoid inopportune opening and tampering.

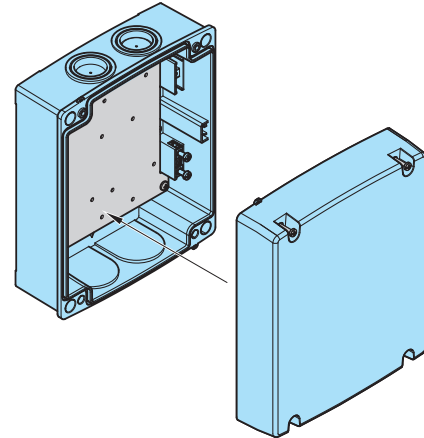
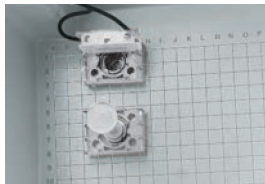
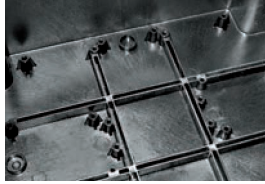

Available space for fitting other electrical or electronic devices

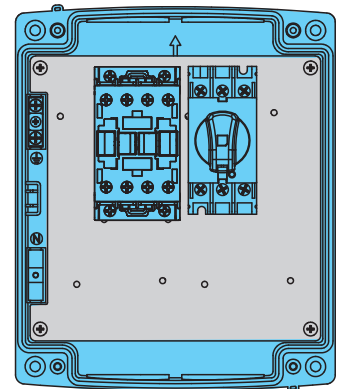
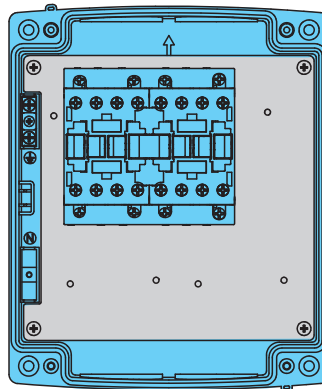
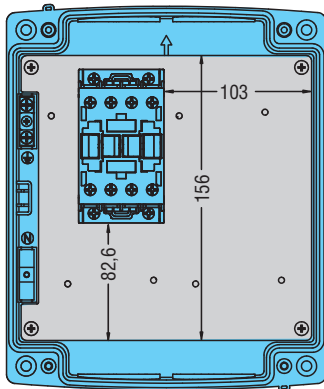

M24N

BG06
BG09
BG12
without overload

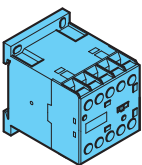

M24N

BF09A...BF25A
without overload

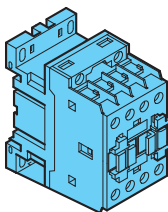

M24N

BGR... - BGT... - BGC... without overload
n° 2 BF09A n° 2 BF12A
n° 2 BF18A n° 2 BF25A
All without overload
BFA...42 without overload

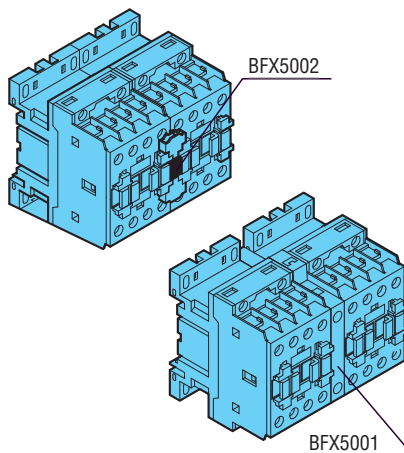

M24N

BF09A BF12A
BF18A BF25A
with GA016A...GA040A and GA063SA

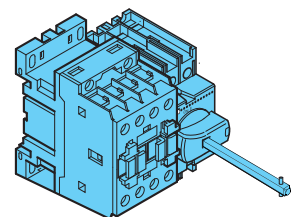

Maximum combinations for starters in M25... enclosure

In addition to a direct-on-line, full voltage across the line, starter or reversing contactor assembly, various other electromechanical devices can be fitted. The cover of the M25 enclosure can be used across the entire surface to mount pushbuttons, measuring instruments, switch disconnectors GA016A...GA040A and GA063SA type. Possible contact blocks or other additional accessories can be mounted on the contactor face of AC or DC BF series or on the contactor side since the cover is deep. Eventually pushbuttons, selector switches and/or other control accessories of the **PLatinum** (plastic series) can be used and contact or LED elements can be mounted directly inside on the cover with the LPXAU120 mounting adapter; refer to section 7.

MX31 internal metal mounting plate is standard-supplied.

The wall fixing holes and the cover closing captive **screws** are positioned **outwards** with respect to the sealing gasket. This guarantees the protection degree of the enclosure against liquid infiltrations (IEC IPX5 / UL Type 4X).

The base has **ribbing** which facilitates the fixing of DIN rails, metal mounting plates and electronic printed boards.

Grid references, marked by letters and numbers, are engraved on the interior surface of the cover. This grid allows to quickly identify the exact drilling points where pushbuttons, handles or pilot lights will be mounted.

A **safety sealing** system keeps the cover and base together to avoid inopportune opening and tampering.

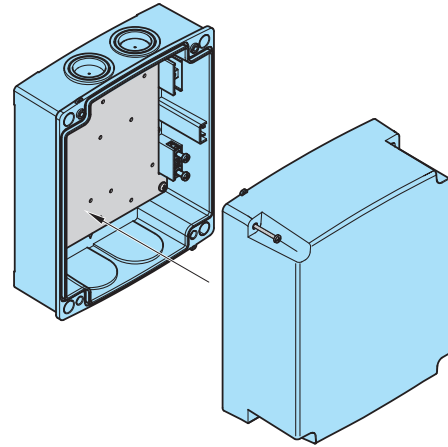
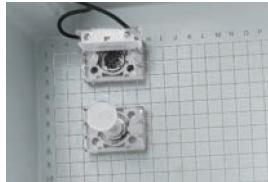
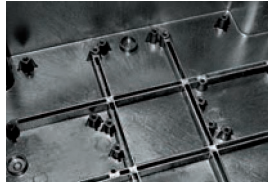

Available space for fitting other electrical or electronic devices

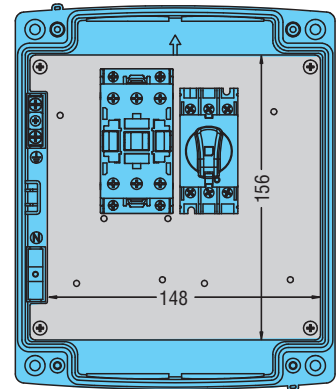
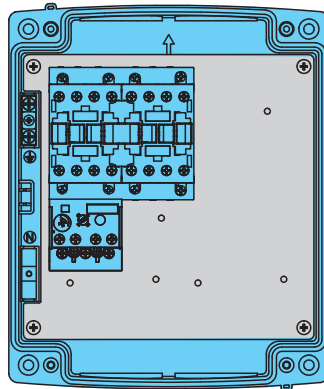
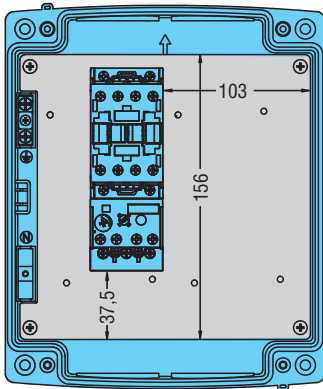

M25...038...

BF38
with or without
overload

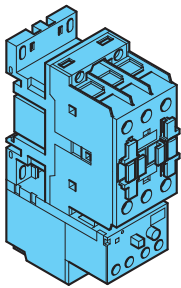

RF38...

M25...

BF26 - BF32
with or without
overload

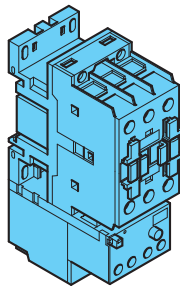

RF38...

M25...

BGR... - BGT... - BGC with or without overload RF9
n° 2 BF26 - n° 2 BF32 - n° 2 BF38 with or without
overload RF38

BFA...42 with or without overload RF38

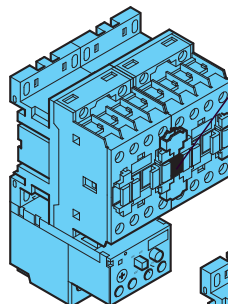

RF38...

BFX5002

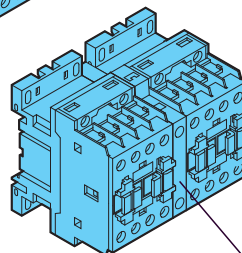

BF09A...BF38A with
BFX5001

M25...

BF09 BF12 BF18
BF26 BF32 BF38
with GA016A...GA040A and GA063SA

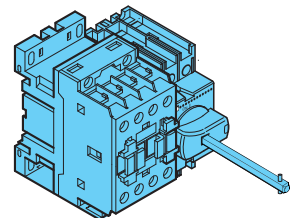

Maximum combinations for starters in M3... enclosure

In addition to a direct-on-line, full voltage across the line, starter or reversing contactor assembly, star-delta starters can be installed as illustrated at the lower right as well as various other electromechanical devices. The cover of the M3 enclosure can be used across the entire surface to mount pushbuttons, measuring instruments or switch disconnectors GA016A...GA125A, etc.

MX30 internal metal mounting plate is standard supplied with M3P... and M3R... types; not included with the M3N, it can be purchased separately.

With the specifically designed **hinges**, the cover remains attached to the base, fully open, while the wiring work is being carried out. By applying **slight pressure** on the hinges, the cover can be released from the base.

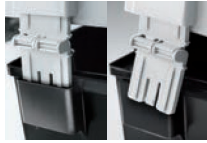

The cover closing captive **screws** and the wall fixing holes are positioned **outwards** with respect to the sealing gasket. This guarantees the protection degree of the enclosure against liquids infiltrations (IEC IPX5 / UL Type 4X).



A **safety sealing** system keeps the cover and base together to avoid inopportune opening and tampering.



Grid references, marked by letters and numbers, are engraved on the interior surface of the cover. This grid allows to quickly identify the exact drilling points where pushbuttons, handle or pilot lights will be mounted.



A properly predrilled metal mounting plate (MX30 standard supplied except for M3N) permits to quickly and precisely fix equipment in place.



The base has **ribbing** which facilitates the fixing of DIN rails, metal mounting plates and electronic printed boards.

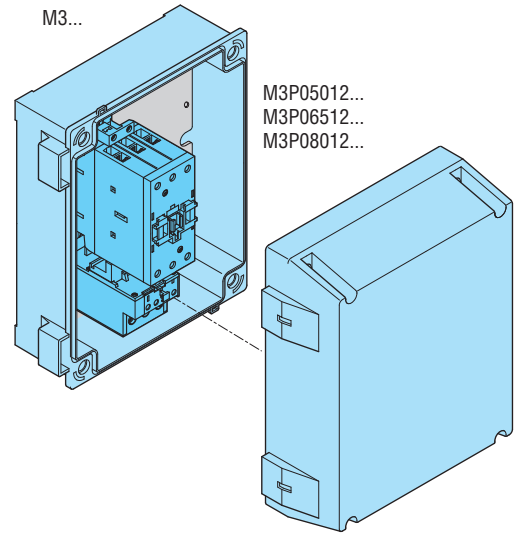

Available space for fitting other electrical or electronic devices

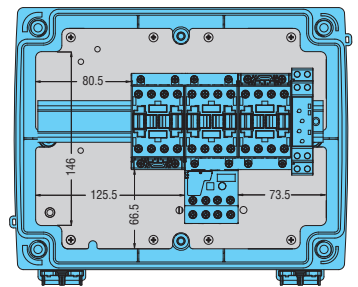
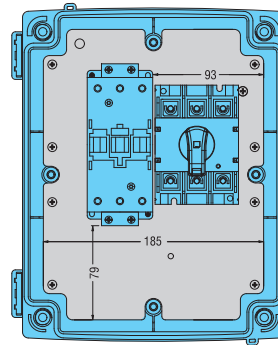
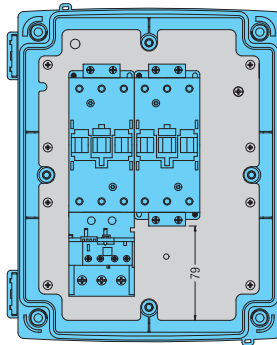
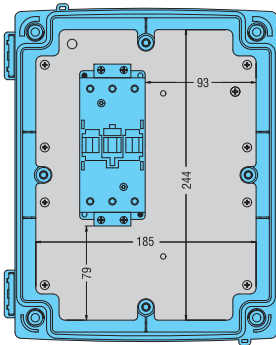

M3...

- n° 1 BF40 n° 1 BF80
- n° 1 BF50 n° 1 BF94
- n° 1 BF65

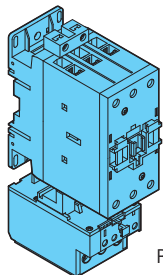

RF82

M3...

- n° 2 BF40 n° 2 BF65 n° 2 BF94
- n° 2 BF50 n° 2 BF80

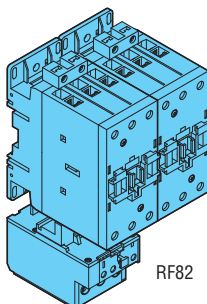

RF82

M3...

- n° 1 BF40 n° 1 BF65 n° 1 BF94 + n° 1 GA...
- n° 1 BF50 n° 1 BF80

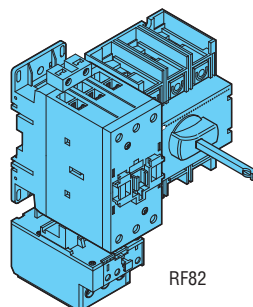

RF82

M3P..70

- Star-delta configuration with RF38 relay, TM ST time relays and contactors: BF09A BF12A BF18A BF25A BF26A BF38A

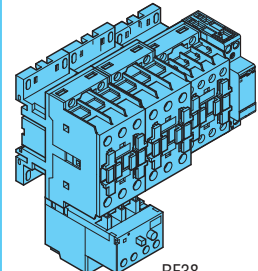

RF38

4 Electromechanical starters and enclosures

Dimensions [mm (in)]

M24N

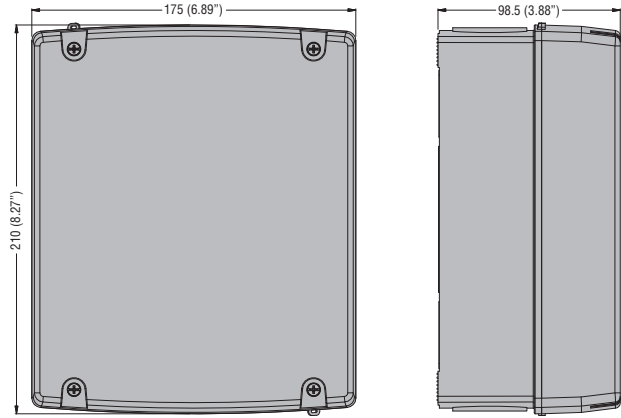

M25

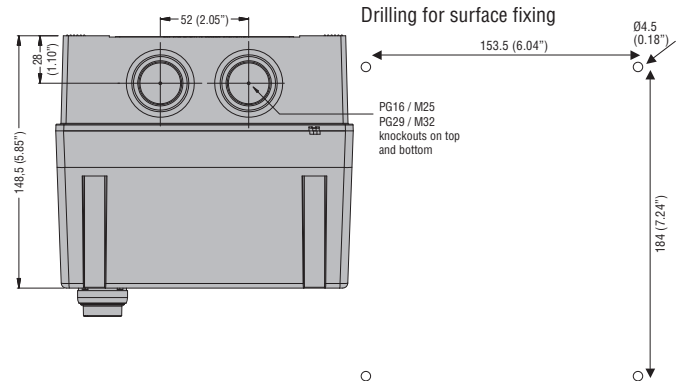
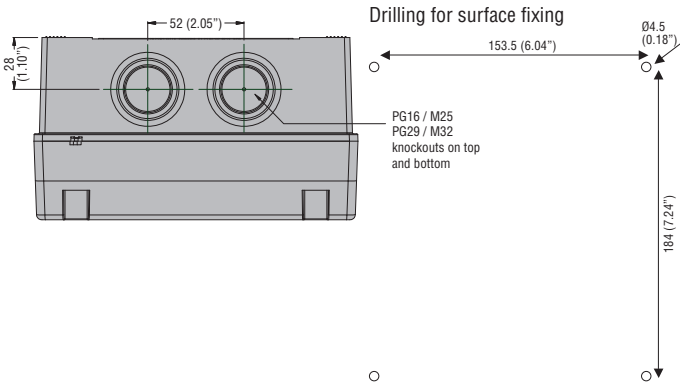
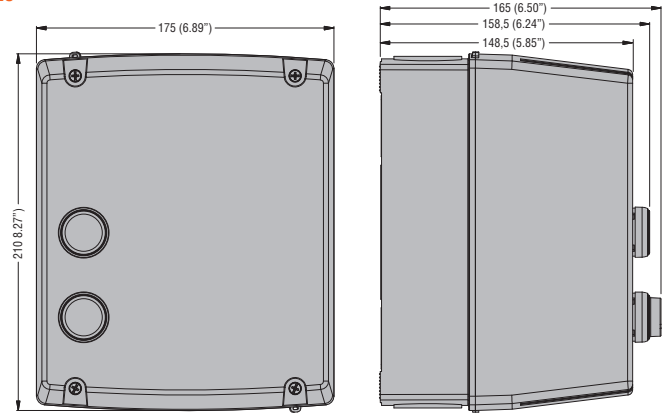

M3

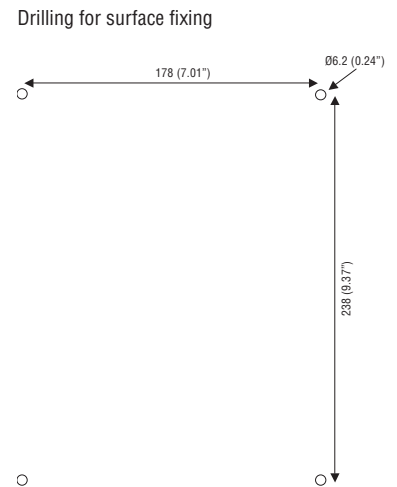
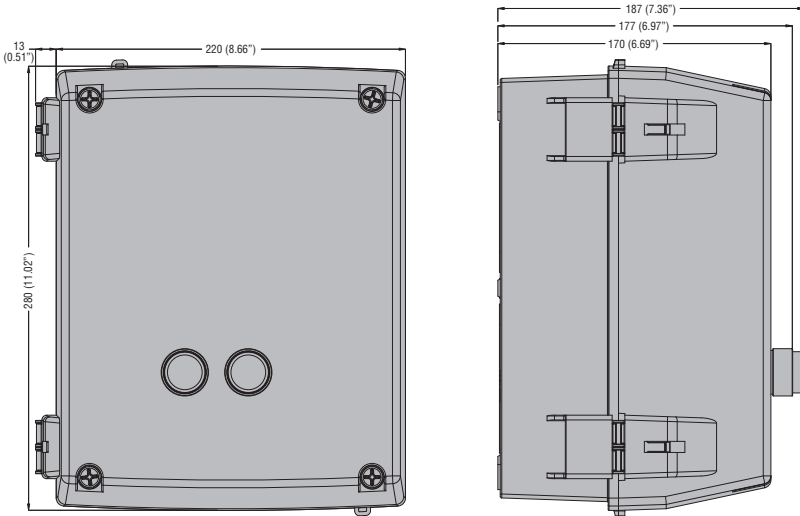

4 Electromechanical starters and enclosures

Dimensions [mm (in)]

REVERSING CONTACTOR ASSEMBLIES

BGR...

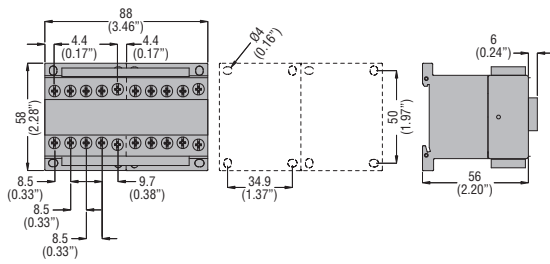

BGT...

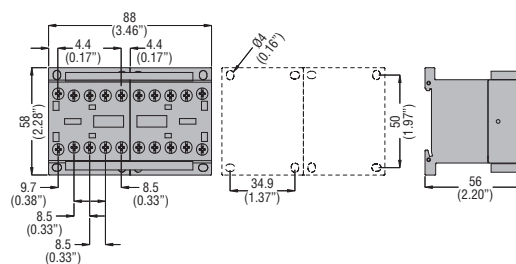

BGTP...

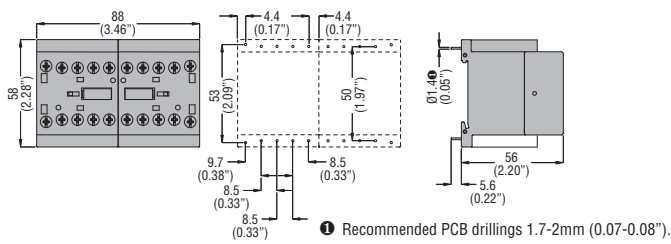

BFA...42

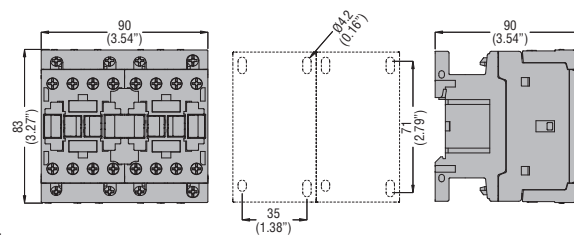

CHANGEOVER CONTACTOR 4 POLES ASSEMBLIES

BGC09T4...

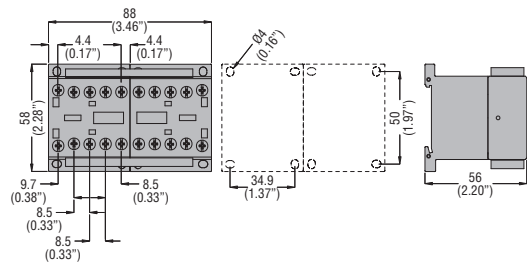

BFC18T4A230

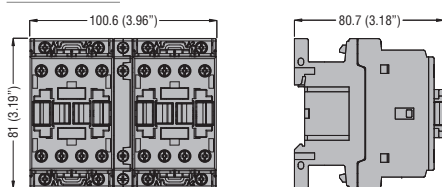

BFC38T4A230

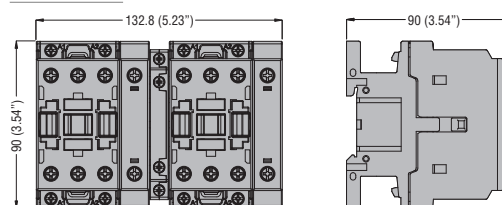

BFC80T4A230

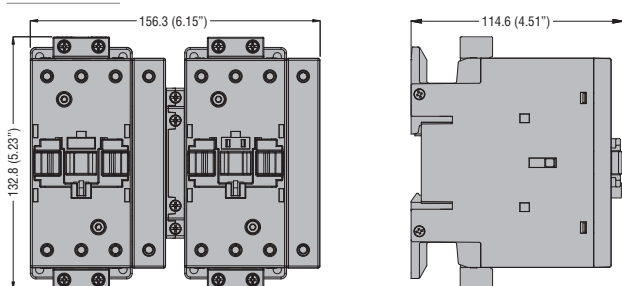

BFC95T4A230 - BFC150T4A230

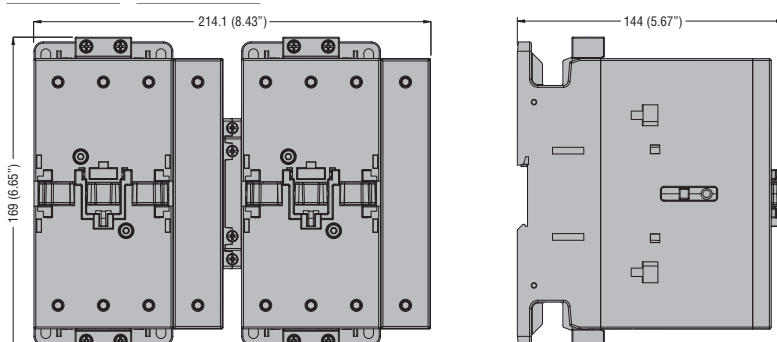

4 Electromechanical starters and enclosures

Dimensions [mm (in)]

STAR-DELTA STARTERS OPEN FRAME

BFA00970...BFA03870

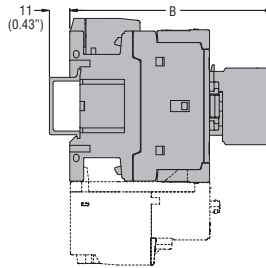
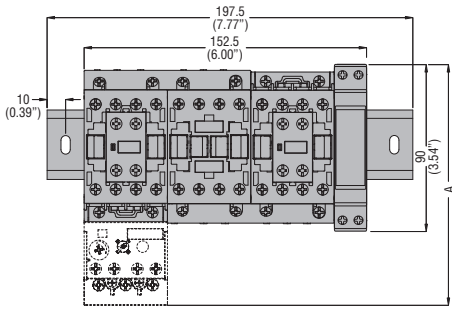

STARTER TYPE	A	B
BFA00970	130.5 (5.14")	109.5 (4.31")
BFA01270	130.5 (5.14")	109.5 (4.31")
BFA01870	130.5 (5.14")	109.5 (4.31")
BFA02570	130.5 (5.14")	109.5 (4.31")
BFA02670	135 (5.14")	119 (4.68")
BFA03270	135 (5.14")	119 (4.68")
BFA03870	135 (5.14")	119 (4.68")

BFA05070...BFA08070

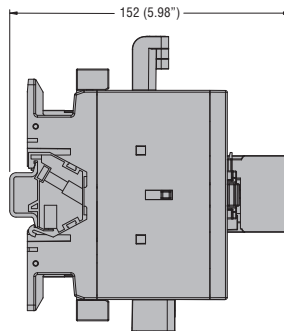
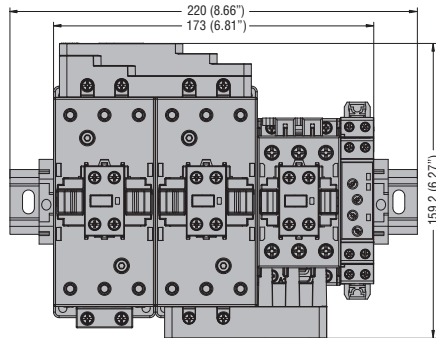

BFA09570...BFA15070

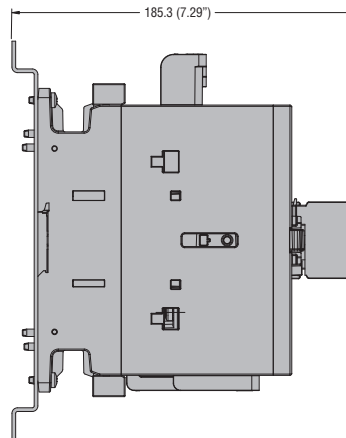
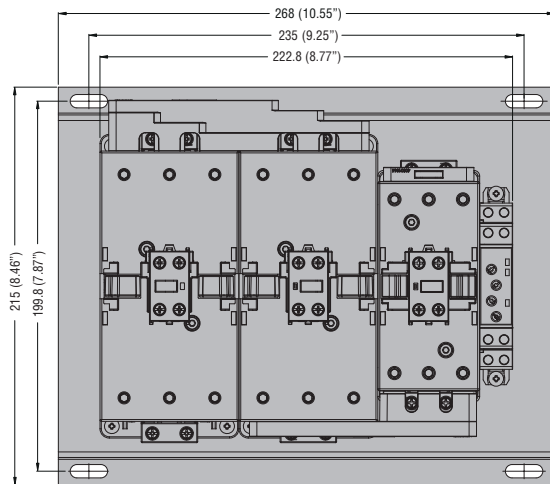

4 Electromechanical starters and enclosures

Dimensions [mm (in)]

STAR-DELTA STARTERS IN ENCLOSURE - EMPTY ENCLOSURE FOR STAR-DELTA STARTERS

M3P...70 - M3PA70

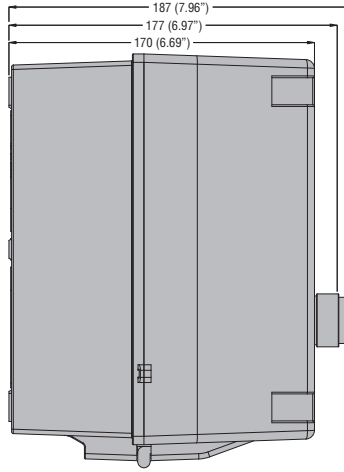
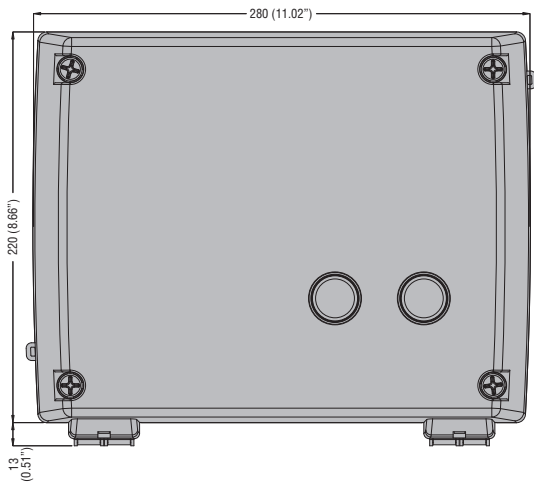

Drilling for surface fixing

2R0

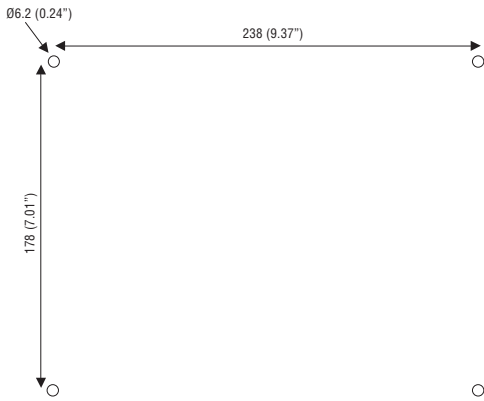

M3P...73

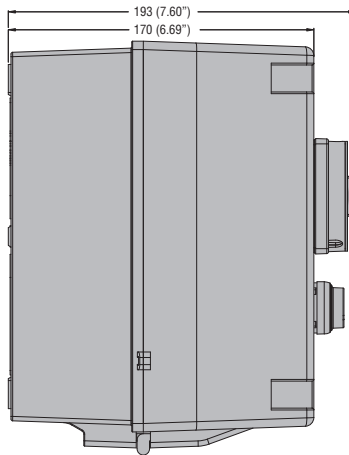
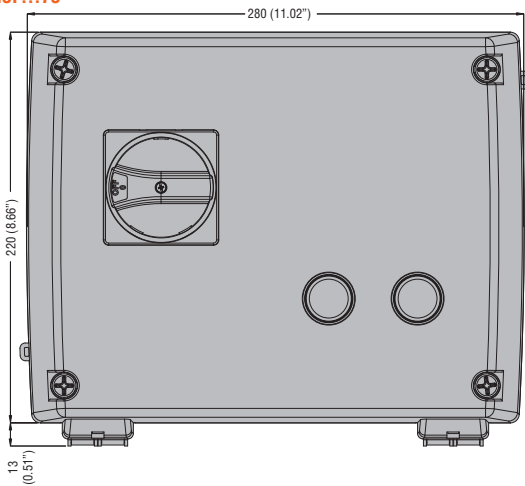

Drilling for surface fixing

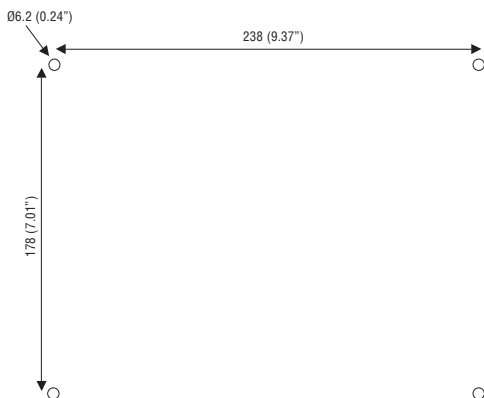

DIRECT-ON-LINE STARTERS IN ENCLOSURE

M...P

Diagram 1 - Incorporated button control for 3-phase motors

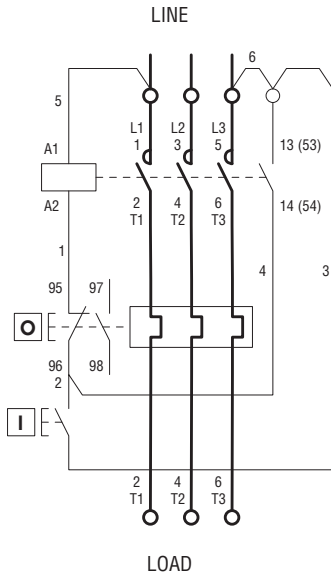

I = Start; O = Stop/Reset

M...R

Diagram 2 - External button control for 3-phase motors

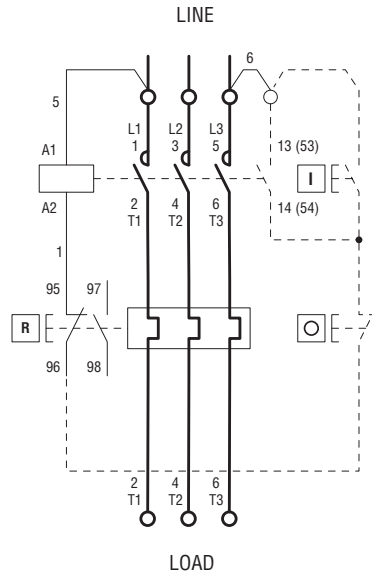

R = Reset; I = Start; O = Stop

M2P00911...

Diagram 3 - Incorporated button control and rotary actuator for 3-phase motors

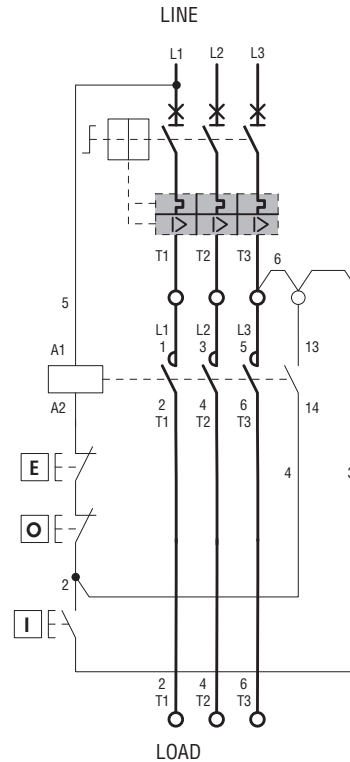

I = Start; O = Stop; E = Emergency Stop

Diagram 4 - Power connection for 1-phase motors

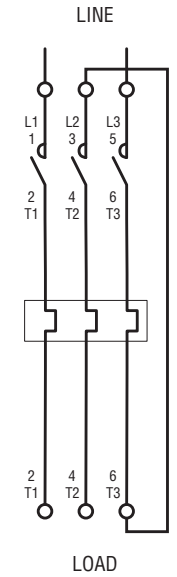

DIAGRAM 2
Connect the eventual two-wire control (e.g. automatism) between terminal 3 of the contactor and terminal 96 of the thermal overload relay.

IMPORTANT

- Remove jumpers 5 and 6 and connect the auxiliary line to terminals A1 and 3 for a control circuit with a voltage value different than the supply.
- Remove jumper 5 and connect the neutral to terminal A1 for a control circuit between phase and neutral.
- SINGLE-PHASE SUPPLY
The main circuit must be configured according to Diagram 4 in the case of a single-phase line or motor.
- FUSES
A set of three fuses must be connected upstream of the starter in the event no appropriate protection is included in the system.

REVERSING CONTACTOR ASSEMBLY

BGR...

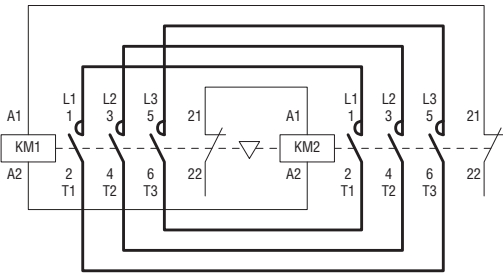

BGT...

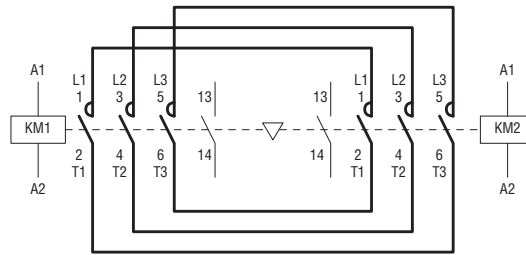

BFA...42

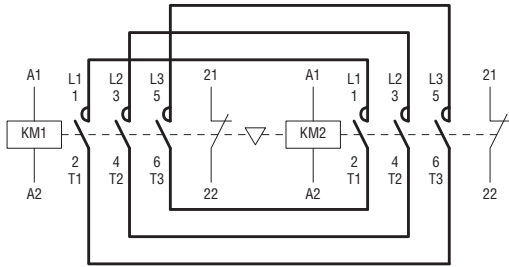

BGTP09...

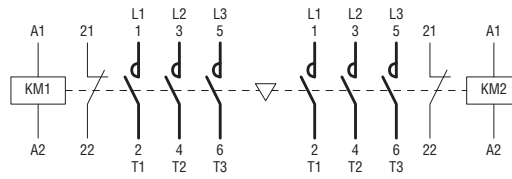

CHANGEOVER CONTACTOR ASSEMBLY

BGC09...

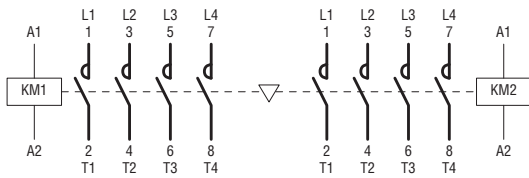

BFC...

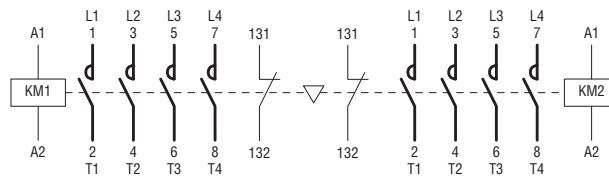

STAR-DELTA STARTERS, OPEN FRAME
BFA009...03870 - M3P009...03870

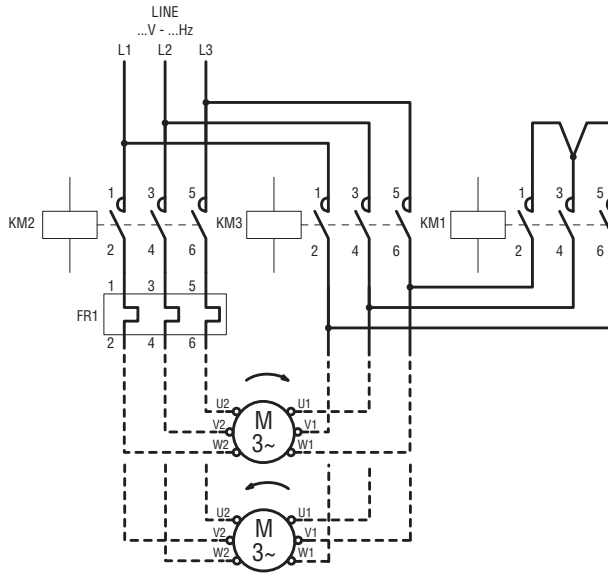

BFA00970... BFA02570
M3P00970...M3P02570

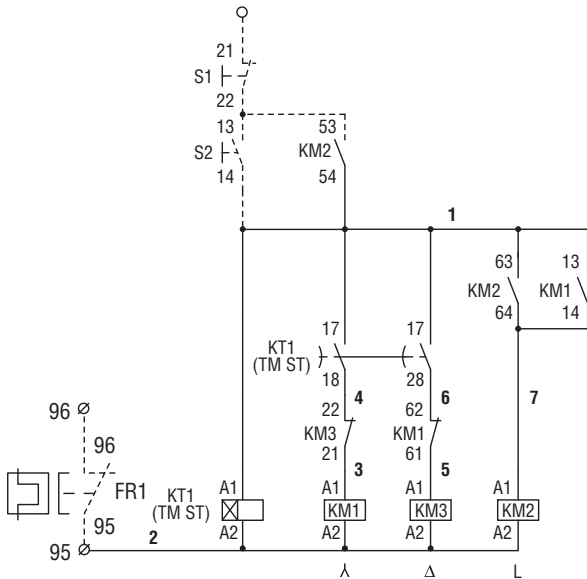

BFA2670...BFA03870
M3P02670...M3P03870

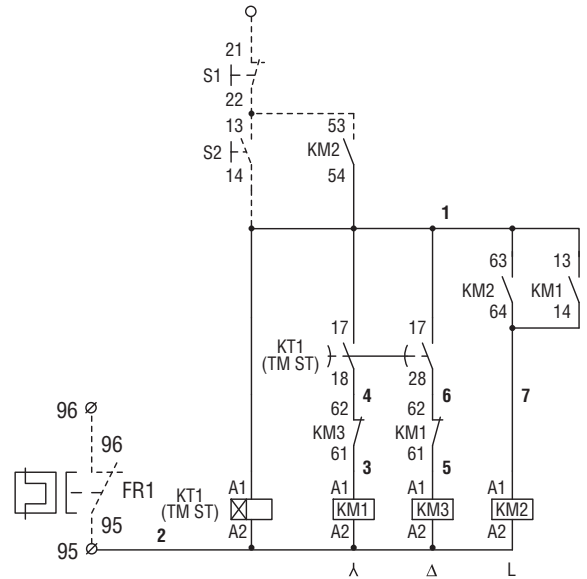

BFA050...BFA150

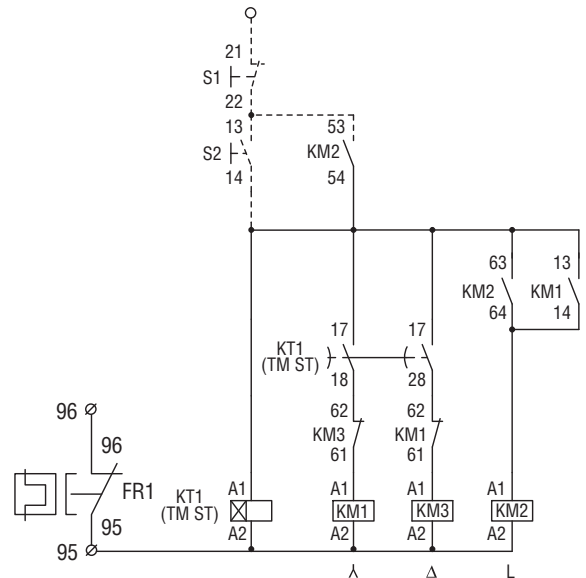
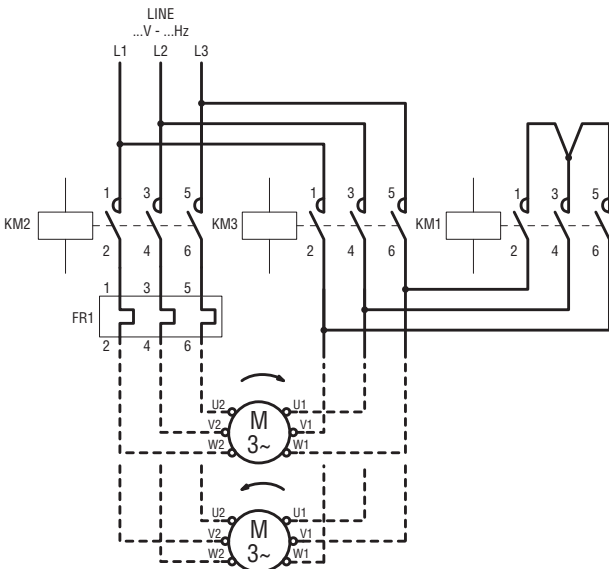

4 Electromechanical starters and enclosures

Direct-on-line starters – Full voltage across the line.
Non reversing

RATINGS FOR USA AND CANADA.

Order code for magnetic motor starters in non-metallic enclosure with 2 push buttons	T/O RELAY ADJ RANGE [A]	MAX UL/CSA HP RATINGS INDICATED ON STARTER (based on t/o relay adj range)					
		Single phase		Three phase			
		120V	240V	200V	240V	480V	600V
M0P009001	0.6 - 1	-	-	-	-	½	½
M0P009001V5	0.9 - 1.5	-	-	-	-	¾	¾
M0P009002V3	1.4 - 2.3	-	-	-	½	1	1
M0P0090033	2 - 3.3	-	¼	¾	1½	1½	2
M0P009005	3 - 5	-	½	1	1	3	3
M0P0090075	4.5 - 7.5	-	¾	1½	2	5	5
M0P009010	6 - 10	½	1½	2	3	5	5
M0P0120015	9 - 15	½	1½	3	3	7½	10
M1P00900A4	0.63 - 1	-	-	-	-	-	½
M1P00900A5	1 - 1.6	-	-	-	-	½	¾
M1P00900A6	1.6 - 2.5	-	-	½	½	1	1½
M1P00900A7	2.5 - 4	-	-	¾	¾	2	3
M1P00900A8	4 - 6.5	¼	½	1	1½	3	5
M1P00900A9	6.3 - 10	½	1½	2	3	5	7½
M1P00900B0	9 - 14	¾	2	3	3	5	7½
M1P01200B0	9 - 14	1	2	5	5	7½	10
M1P01800B1	13 - 18	1	3	5	5	10	15
M2P02500B2	17 - 23	1½	3	5	7½	15	15
M2P02500B3	20 - 25	2	3	7½	7½	15	15
M2P02600B2	17 - 23	1½	3	5	7½	15	20
M2P02600B3	20 - 25	2	5	7½	7½	15	20
M2P02600B4	24 - 32	2	5	7½	7½	15	20
M2P03200B4	24 - 32	3	7½	10	10	20	25
M25P03800B5	32 - 38	3	7½	10	15	30	30
M3P05000B6UL	35 - 50	5	10	15	20	40	40
M3P06500B7UL	46 - 65	-	-	20	25	50	60
M3P08000B8	60 - 82	-	-	25	30	60	75

NOTE: the HP / FLA values vary from one motor to another; if possible, always verify the HP and FLA (or rated current) on the motor nameplate. Enclosure UL Type 1, 12, 4 and 4X industrial control environment for M1, M2, M25 and M3...UL versions; designation of control units can be:

N – without push buttons
R – with reset button only
P – per table, with start-stop push buttons.
Consult Technical support for any other combination required (e.g. with other type of contactors, contactor assemblies or definite-purpose version, different overload version or range, additional pilot lights, extra electrical or electronic elements); see contact details on inside front cover. Refer to ① below for specified standard configurations.

- ① Complete the order code by indicating:
 - 10 if required without thermal overload relay
 - 12 if required with three-phase overload relay
 - 17 if required with disconnect switch for M2 and M3 types.
- ② Complete order code with coil voltage digit (if 50/60Hz) or with voltage digit followed by 60 (if 60Hz).
Standard voltages are as follows:
 - AC 50/60Hz 024 / 048 / 110 / 230 / 400V
 - AC 60Hz 024 60 / 048 60 / 120 60 / 220 60 / 230 60 / 460 60 / 575 60 (V).
- ③ Maximum UL ratings is 52A for motor control and 65A for general use.
- ④ No CSA or UL certification. Indicated values correspond to UL/CSA magnetic contactor ratings and for indication and reference purposes only.

Certifications obtained:

- CSA certified for Canada and USA (cCSAus - File 94157) as Magnetic Motor Controllers at max 600VAC, max 15HP per single phase, max 60HP three phase, max 125A with general purpose enclosure.
- UL Listed for USA and Canada (cULus - File E93602) as Magnetic Motor Controllers – Enclosed.



4 Electromechanical starters and enclosures

Typical full-load current values of single and three phase electric motors

THREE-PHASE POWER RATINGS		Rated motor current								
[HP]	[kW]	200V [A]	230V [A]	220-240V [A]	380-415V [A]	400V [A]	440-480V [A]	500V [A]	550-600V [A]	690V [A]
-	0.37	-	1.9	-	-	1.1	-	0.88	-	0.64
1/2	-	2.5	-	2.2	1.3	-	1.1	-	0.9	-
-	0.55	-	2.6	-	-	1.5	-	1.2	-	0.87
3/4	-	3.7	-	3.2	1.8	-	1.6	-	1.3	-
1	-	4.8	-	4.2	2.3	-	2.1	2	1.7	-
-	0.75	-	3.3	-	-	1.9	-	1.5	-	1.1
-	1.1	-	4.7	-	-	2.7	-	2.2	-	1.6
1-1/2	-	6.9	-	6	3.3	-	3	-	2.4	-
2	-	7.8	-	6.8	4.3	-	3.4	-	2.7	-
-	1.5	-	6.3	-	-	3.6	-	2.9	-	2.1
-	2.2	-	5.5	-	-	4.9	-	3.9	-	2.8
3	-	-	11.3	-	-	6.5	-	5.2	-	3.8
-	4	-	15	-	-	8.5	-	6.8	-	4.9
5	-	17.5	-	15.2	9.7	-	7.6	-	6.1	-
-	5.5	-	20	-	-	11.5	-	9.2	-	6.7
7-1/2	-	25.3	-	22	14	-	11	-	9	-
10	-	32.2	-	28	18	-	14	-	11	-
-	7.5	-	27	-	-	15.5	-	12.4	-	8.9
-	11	-	38	-	-	22	-	17.6	-	12.8
15	-	48	-	42	27	-	21	-	17	-
20	-	62.1	-	54	34	-	27	-	22	-
-	15	-	51	-	-	29	-	23	-	17
-	18.5	-	61	-	-	35	-	28	-	21
25	-	78.2	-	68	44	-	34	-	27	-
-	22	-	72	-	-	41	-	33	-	24
30	-	92	-	80	51	-	40	-	32	-
40	-	120	-	104	66	-	52	-	41	-
-	30	-	96	-	-	55	-	44	-	32
-	37	-	115	-	-	66	-	53	-	39
50	-	150	-	130	83	-	65	-	52	-
60	-	177	-	154	103	-	77	-	62	-
-	45	-	140	-	-	80	-	64	-	47
-	55	-	169	-	-	97	-	78	-	57
75	-	221	-	192	128	-	96	-	77	-
100	-	285	-	248	165	-	124	-	99	-
-	75	-	230	-	-	132	-	106	-	77
-	90	-	278	-	-	160	-	128	-	93
125	-	359	-	312	208	-	156	-	125	-
-	110	-	340	-	-	195	-	156	-	113
150	-	414	-	360	240	-	180	-	144	-
-	132	-	400	-	-	230	-	184	-	134
200	-	552	-	480	320	-	240	-	192	-
-	160	-	487	-	-	280	-	224	-	162
250	-	-	-	604	403	-	302	-	242	-
-	200	-	609	-	-	350	-	280	-	203
300	-	-	-	722	482	-	361	-	289	-
-	250	-	748	-	-	430	-	344	-	250
350	-	-	-	828	560	-	414	-	336	-
400	-	-	-	954	636	-	477	-	382	-
-	315	-	940	-	-	540	-	432	-	313
450	-	-	-	1030	-	-	515	-	412	-
-	355	-	1061	-	-	610	-	488	-	354
500	-	-	-	1180	786	-	590	-	472	-

SINGLE-PHASE POWER RATINGS	Rated motor current	
	[A] at 120V	[A] at 240V
1/10	3	1.5
1/8	3.8	1.9
1/6	4.4	2.2
1/4	5.8	2.9
1/3	7.2	3.6
1/2	9.8	4.9
3/4	12.8	6.9
1	16	8
1-1/2	20	10
2	24	12
3	34	17
5	56	28
7-1/2	80	40
10	100	50
15	135	68

The information in the chart has been obtained from the IEC/EN/BS 60947-4-1 standards. The kW ratings are preferred rated values according to IEC 60072-1 (primary series) at 50/60Hz while Horsepower and corresponding current values are according to UL 508 Industrial Control Standard at 60Hz.

The full load current values listed are for motors running at standard speeds with normal torque characteristics. Motors which are non-standard, such as low speed, high torque or other special applications may have higher full load currents.

Caution: for accurate and reliable motor protection, motor nameplate current should be used to obtain actual motor full load amps for all motors. The information given is for indication and reference purposes only.



- 6A to 1200A soft starter ratings
- Standard and severe duty types
- Internal bypass contactor up to 320A rating
- Versions with advanced functions for the control of the motor
- Startup with torque control, voltage ramp with current limit
- Protection functions for the motor and the soft starter
- Clock calendar
- Digital control and adjustment
- NFC connectivity for a simple, fast and intuitive programming with smartphone and App
- RS232 and RS485 for monitoring and remote control

Soft starters

Type ADXN... 2 phase control ultra compact	5 - 6
Accessories for ADXN...	5 - 7
Type ADXL... 2 phase control	5 - 8
Accessories for ADXL...	5 - 9
Type 51ADX... 3 phase control	5 - 10
Accessories for 51ADX...	5 - 11
Software and APP	5 - 12

Dimensions	5 - 13
-------------------------	---------------

Wiring diagrams	5 - 17
------------------------------	---------------

Technical characteristics	5 - 18
--	---------------

SEC. - PAGE



Page 5-6

ADXN...

- Two phase control
- IEC rated soft starter current Ie 6...45A
- Rated operational voltage 208...600VAC
- Version with auxiliary supply voltage 24VAC/DC or 100...240VAC
- IEC rated motor power 2.2...22kW (400VAC)
- Built-in bypass relay
- Basic version with parameter setting with potentiometers on front
- Version with NFC connectivity for the programming of parameters with smartphone and APP
- Advanced version with potentiometers and NFC connectivity, optical port, electronic current thermal protection and optional RS485 module, Modbus-RTU protocol
- Integrated protections for the motor and soft starter
- LED for the signalling of the status of the soft starter
- Compact housing, 45mm width
- Screw fixing or 35mm DIN rail mounting.



Page 5-8

ADXL...

- Two phase control
- For standard and severe duty
- Reduced voltage starter with torque control and built-in bypass relay
- Rated operational voltage 208...600VAC
- IEC rated starter current Ie 18...320A
- Selectable motor current from 50 to 100% of the rated starter current
- IEC rated motor power 7.5...160kW (400VAC)
- Maximum starting current limitation
- PC remote control
- Programming, data download and diagnostics via optical port
- NFC connectivity for the programming of parameters with smartphone and APP
- Modbus-RTU and Modbus-ASCII communication protocols with optional RS485 card
- Backlit LCD icon display
- Integrated protections for the motor and soft starter
- LED for the signalling of the status of the soft starter.



Page 5-10

51ADX...

- Three phase control
- Reduced voltage starter with torque control
- Built-in bypass contactor up to 245A
- For severe duty, IEC starting current 5•Ie
- Rated operational voltage 208...500VAC (51ADX...B) 208...415VAC (51ADX...)
- IEC rated starter current Ie 17...1200A
- IEC rated motor power 7.5...710kW (400VAC)
- Maximum starting current limitation
- PC remote control supervision with built-in RS232 port
- Modbus-RTU and property ASCII communication protocols
- Backlit LCD icon display.



Guide for selecting

	ADXN	ADXL	51ADX
Controlled phases	2	2	3
Built-in bypass	●	●	● (up to 245A)
Built-in display and keypad	—	●	●
Languages	—	6	4
View measurements	—	●	●
Torque control	—	●	●
Adjustable current limit	● (ADXNP)	●	●
Dynamic braking	—	—	●
Kick Start function	—	●	●
Motor overload electronic protection	● (ADXNP)	●	●
Motor protection PTC input	—	●	●
Protection against phase loss	●	●	●
Protection against phase inversion	●	●	●
Protection against locked rotor	● (ADXNP)	●	●
Protection against thyristor overtemperature	●	●	●
Protection against low load	● (ADXNP)	●	●
Programmable alarm functions	● (ADXNF, ADXNP)	●	●
Digital inputs	● (start)	●	●
Analog inputs	—	—	●
Digital outputs	●	●	●
Analog output	—	—	●
Monitoring communication	○ (ADXNP, RS485)	○ (RS485)	● (RS232)
Optical port for programming	● (ADXNP)	●	—
Event log	—	●	●
Motor hour counter	—	●	●
Startup counter	—	●	●
Clock calendar	—	—	●
Remote external keypad	—	○	○

- Standard
- Optional
- Not available

ADXN SERIES: SIMPLE, COMPACT AND FUNCTIONAL

The soft starters ADXN series are the ideal solution for those who need a **simple, compact and fast to configure** product for the gradual control of the starting and stopping of the motors. Their **versatility** makes them suitable for several applications such as the control of pumps, fans, conveyor belts, compressors and they are available with **rated currents from 6 to 45A**.



VERSIONS

The soft starters ADXN series are available in three versions.

Basic version (ADXNB)



Ideal solution for those who need a soft starter with basic functions and extremely simple to configure, with the only purpose to control the gradual starting and the stopping of the motor. The configuration requires the settings of only 3 parameters (starting voltage, acceleration ramp and deceleration ramp) adjusted with 3 **potentiometers** present on the front of the soft starter.

NFC version (ADXNF)



Version provided with **NFC** (Near Field Communication) connectivity for the programming via smartphone and LOVATO **NFC** App. The default settings make it ready to use for the control of scroll compressors, typically used in conditioning systems, refrigerators and heating pumps without need for any programming. Thanks to the NFC antenna integrated on front it is however possible to modify the parameters of the soft starter via smartphone for the control of loads different from compressors, like pumps, fans, conveyors, etc. solution which makes ADXNF extremely flexible for any kind of application.

The setting of parameters in digital format guarantees accuracy and repeatability, with possibility to set the programming on the smartphone to be immediately transferred on others ADXNF. It is also possible to configure a password for the lock of the settings to protect the soft starter against tampering of the parameters by unauthorized personnel.

Advanced version (ADXNP)



Version which provides the **electronic thermal overload protection** of the motor, obtained thanks to the presence of integrated current transformers, which allow the protection of the motor against overload and the management of starting ramps with current limiting, which are automatically adapted to follow the load variations. The soft starter ADXNP can also be equipped with an **optional RS485 communication module (CX04)** in order to be integrated in a remote control and supervision system. It is provided with both **potentiometers** on front for the setting of the basic parameters (starting voltage, acceleration ramp and deceleration ramp) and **NFC connectivity** for the programming of the advanced parameters through the LOVATO **NFC** App, such as the rated motor current, the tripping thermal class, protection thresholds, password, communication parameters, the function of the relay outputs and alarm properties. The **frontal optical port** allows the programming, data download and diagnostic from PC and App with the optional USB (CX01) and Wi-Fi (CX02) devices.

COMPACT DIMENSIONS

The soft starters ADXN series are characterized by two phase control and are realized in an extremely compact enclosure **only 45mm wide** for the entire range up to 45A (divided in 2 mechanical sizes that differ in height and depth).



SIMPLICITY

They are extremely **simple and quick to configure**. The control of the motor requires only the setting of **few and intuitive parameters**, such as the ramp times and the starting voltage, which can be configured according to the version with potentiometers on front or via smartphone with NFC technology and LOVATO **NFC** App, available for free for iOS and Android smart devices.

WIDE OPERATIONAL VOLTAGE RANGE

They are characterized by a wide rated line voltage range, which extends **from 208 to 600VAC**; this makes them suitable for every market, including the North American one, without needs to manage different codes according to the supply voltage available in the system.

AUXILIARY POWER SUPPLY

All the three versions of ADXN are available with 2 auxiliary power supply voltages: **24VAC/DC**, typical voltage value available in the automation control panels, or **100-240VAC**, typical voltage available for example in the panels for pumps control.

INTEGRATED PROTECTION FUNCTIONS

They integrate several functions for the protection of the motor and the soft starter, such as:

- soft starter thermal protection made by a built-in temperature probe installed on the heatsink
- controls on the line voltage: voltage and frequency out of limits, phase loss, wrong phase sequence
- electronic thermal protection of the motor (ADXNP version only).

The protection thresholds and tripping delays are configurable on the versions provided with NFC connectivity (ADXNF and ADXNP) and can be individually enabled or disabled.

NFC CONNECTIVITY AND PROTECTION OF THE SETTINGS

The ADXNF and ADXNP versions are provided with NFC connectivity integrated on the front, technologically advanced solution which allows the modification of the parameters in a **fast, simple and intuitive** way directly from the **smartphone with LOVATO NFC App**. Thanks to the NFC it is possible to set the parameters in digital format in a clear and precise way using the user-friendly **graphical interface** of the App.



It is also possible to save the programming on the smartphone to be **copied** on other soft starters of the same model extremely fast, **even with the device powered off**, solution ideal for those who make programming in series of several devices. In addition to the fast speed, accuracy and simplicity of configuration, the versions provided with NFC connectivity allow to satisfy **safety** requirements thanks to the possibility to set via smartphone a **password** to protect the parameters against tampering by unauthorized personnel. The LOVATO **NFC** App is available for **Android and iOS** smart devices and it is freely downloadable from Google Play Store and App Store.

ELECTRONIC MOTOR THERMAL OVERLOAD PROTECTION (ADXNP version only)

The advanced version ADXNP integrates current transformers for the measure of the current flowing in the motor phases. With this information the soft starter can thermally protect the motor commanding it to stop when the current exceeds the rated value for an extended time, without the necessity to install an external thermal overload relay, resulting in cost, space, wiring and installation time savings. The thermal protection is electronic type and it is possible to set a double protection class: one for the starting and one for the running, at choice between class 10, 15, 20 and 25 according to the duty level of the application. The rated motor current, the thermal protection classes and their alarm properties are configurable via smartphone with LOVATO **NFC** App or LOVATO **Sam1** App.

OPTICAL PORT FOR COMMUNICATION (ADXNP version only)

The advanced version ADXNP is provided with optical port on front for the connection of the optional USB (CX01) or Wi-Fi (CX02) devices, by which the soft starter can be connected to a PC with software **Xpress**, smartphone and tablet with LOVATO **Sam1** App to carry out operations of programming, diagnostic and data download in simple and safe way, by operating directly from the front of the soft starter without the need to disconnect the electrical panel power supply.



RS485 COMMUNICATION PORT (ADXNP version only)

The advanced version ADXNP can be equipped with the optional RS485 communication module CX04. With this module the soft starter is provided with a **serial RS485 communication port with Modbus-RTU** protocol to be integrated in supervision and monitoring system or to communicate with a Modbus master like a PLC or HMI. The module is provided with terminals for the 24VAC/DC auxiliary power supply and it connects in simple and fast way to the optical port of the soft starter with screw fixing. The communication between the soft starter and the RS485 module is done through the optical interface, which ensures electrical safety and comfort of operate directly from the front. It is compatible with **Synergy** supervision and energy management software.



BUILT-IN BYPASS

All the versions integrate a **bypass** relay which automatically deactivates the thyristors circuit once the acceleration ramp is completed and the motor reaches its run condition, allowing the reduction of the heat and the power dissipation, which consequently results in **energy saving**. The presence of the bypass also increases the reliability of the soft starter, by protecting the internal thyristors against unpredictable phenomena on the network during the motor running, such as short circuits, overcurrents or overvoltages.

2 RELAY OUTPUTS INTEGRATED

The soft starters ADXN have 2 built-in relay outputs with normally open contact, which can be used for signaling functions or for the command of external devices. The function of the outputs is fixed on the basic versions ADXNB, while it is programmable via NFC technology on the versions ADXNF and ADXNP at choice between line contactor control (Run), TOR (Top Of Ramp), alarm and maximum torque.

PASSWORD

The access to the parameters of the soft starters ADXNF and ADXNP can be locked with a password configurable with the LOVATO **NFC** App to protect the settings against tampering by unauthorized personnel.

FRONTAL LEDS

All the three versions have 3 LEDs on the front for the signalling of the presence of auxiliary power supply, run status and alarm. In case of active alarm the alarm LED is flashing and the type of alarm in progress can be identified by the number of flashes.

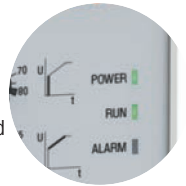

MOUNTING

The soft starters ADXN can be fixed with screws on the rear panel or on 35mm DIN rail (IEC/EN/BS 60715). For the screw fixing there are 4 holes on the base of the soft starter enclosure, while for the DIN rail fixing there is a rubber pad insert which prevents the soft starter from sliding on the DIN rail.

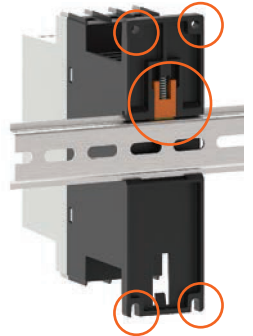

FAN

It is possible to install on the soft starter ADXN up to 30A an optional fan **40x40mm** (already built-in on the sizes 38A and 45A) to improve the heating dissipation performances and increase the number of operations per hour. The fan is supplied directly by the soft starter through a pre-wired cable which is completely hidden inside the soft starter enclosure. The presence of the fan doesn't affect the dimensions of the soft starter ensuring the maintenance of compact dimensions.



RIGID CONNECTION FOR THE DIRECT MOUNTING TO A MOTOR PROTECTION CIRCUIT BREAKER (MPCB)

The rigid connection SM1X3150R allows the direct mounting of the soft starter ADXN to a motor protection circuit breaker type SM1R (rotary knob type) up to size 38A, allowing the realization of compact starters and reducing the installation time. SM1X3150R includes an accessory for the support of the weight of the soft starter when hooked to the MPCB, to be fixed with screws to the panel. This support can be used with high or low DIN rail and it can be mounted even with soft starter already installed without need to modify the drillings.



ADXL SERIES SIMPLE, EFFICIENT AND SAFE MOTOR CONTROL



SIMPLE

The ADXL soft starter series is equipped with a backlit LCD display with icons and NFC connectivity, for a simple configuration, possible also via smartphones and tablets. They are ideal for simple “plug and play” applications, thanks to the installation AUTO SET wizard, and for high-performance applications, with control and protection during the motor startup and operation.

EFFICIENCY

The two-phase control during the start and stop of the motor allows a reduction of the heat dissipation.

After the start-up is completed, the soft starter closes the internal bypass contacts and reduces energy consumption.

SAFETY

ADXL built-in functions allow to protect the connected motor and the starter; it's capable of monitoring the motor thermal status, to manage the thermal protection, and its internal temperature, in order to protect the thyristors from overtemperature. Furthermore, a motor overtemperature protection can be enabled through an external PTC temperature sensor.

AUTO SET

Upon startup, the soft starter launches a user wizard to simplify the setup. The user can set the device through 4 simple parameters:

- **language:** it is possible to choose the text view by selecting the preferred language. The available languages are: English, Italian, French, Spanish, Portuguese, German;
- **motor current size:** the motor nominal current (can be set between 50% and 100% of the rated soft starter current);
- **application type:** it includes predefined setups for the most common applications: centrifugal pump, fire fighting pump, conveyor belt, fan, mixer and general purpose. By selecting one type, the soft starter automatically updates the parameter programming to adapt to the requested application.
- **soft starter duty level:** the same application, based on the load connected to the motor, can be more or less heavy-duty. ADXL is capable of automatically adapting to standard or heavy-duty startups by adjusting the related parameters based on the user selection.

Expert users can customize the settings through the complete parameter menu.

EASY SETUP

The ADXL series soft starters are equipped with NFC technology to simplify the parameter setting procedure. Using a compatible smartphone or tablet, the user, even with the soft starter turned off, can download, save and edit the parameter menu using the LOVATO **NFC** App. The device front includes an optical port compatible with the CX01 device, to connect it via USB to the PC with **Xpress** software, and the CX02 device, for Wi-Fi connection to the PC with **Xpress** software or to smartphone and tablet with LOVATO **Sam1** App.



ADXL:
from start-up
to operation
in 4 steps

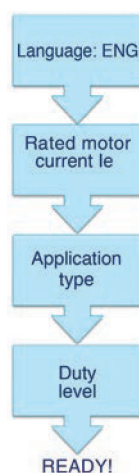

LOVATO **NFC** App and LOVATO **Sam1** App freely downloadable from Google Play Store and App Store.



TORQUE CONTROL

The ADXL soft starters integrate the torque control. This motor starter solution allows to perform gradual accelerations and decelerations, with consequent significant reduction of mechanical faults and wear of the transmission devices.

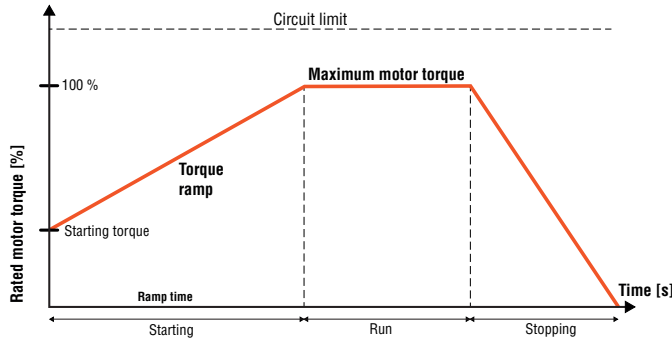

KICK START

This function allows to start the motor when the initial torque is not sufficient to overcome friction forces typical of high inertia loads, by providing a high torque during the very first moments of the startup.

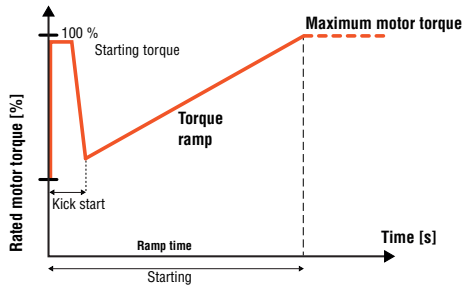

FIRE FIGHTING PUMP PRESET SETUP

While choosing the application in the AUTO SET wizard, it is possible to select the fire fighting pump application. This parameter setting is optimized to start fire fighting pumps overriding all alarms and protections. In this situation, the main priority is the pump start-up, without considering the possible consequences for the pump starter and motor.

INPUTS, OUTPUTS, LIMITS AND REMOTE VARIABLES

The input and output functions are preset with the most common settings; the user can easily edit the preset configuration to adapt the soft starter to the application needs. All inputs and outputs can be edited. There are three types of programmable internal variables:

- limit thresholds
- remote variables
- user alarms.

MAINTENANCE COUNTERS

ADXLs have two counters dedicated to count the number of start-ups and the motor operation hours. It is possible to set a threshold for the operation hours; when this threshold is exceeded, a dedicated alarm is triggered.

COOLING FAN

The fan is supplied as an accessory for sizes from 18 to 115A, while it is built-in for all larger sizes. In order to increase its life span, the fan is activated only when necessary. Furthermore, the ADXL is capable of checking the fan conditions; any blocks or faults are signalled through two specific alarms.

DIN MOUNT GUIDE

For sizes from 18 to 115A, the EXP8003 accessory is available to mount the soft starter on a 35mm DIN rail.



USER INTERFACE

A backlit icon display shows the data to the user in a clear and immediate way.

- Alarm texts available in 6 languages (ENG-ITA-FR-ES-POR-DE)
- 6 icons indicate the default setup in use: centrifugal pump, fire fighting pump, conveyor belt, fan, mixer and general purpose
- Two graphic bars show the motor and thyristors thermal status
- Two alphanumeric displays allow to view texts and measures
- A status bar shows the soft starter status: start, bypass, run, stop.

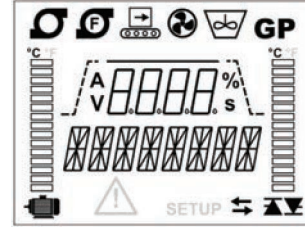

PASSWORD

Access to the soft starter parameters can be protected by user customizable passwords. There are two access levels, user and advanced. Furthermore, it's possible to block the serial communication using the remote control password.

RS485 COMMUNICATION AND REMOTE KEYPAD

All ADXL series soft starters are equipped with a slot to house the EXC1042 MiniCard, an expansion dedicated to the RS485 port, Modbus protocol. RS485 communication can be used to connect the soft starter to a supervision software (e.g. Synergy) or for the connection to the EXCRDU1 remote display unit, to view the measures or to perform the setup through the touch screen installed on the front panel and command the start and stop of the motor.



MONITORING AND REMOTE CONTROL

Through the optional EXC1042 communication card and compatibility with the supervision and energy management software Synergy, setup and remote control software Xpress, it's possible to constantly monitor all the measures available on the soft starter, the soft starter status, see live trends and edit the setup parameters.

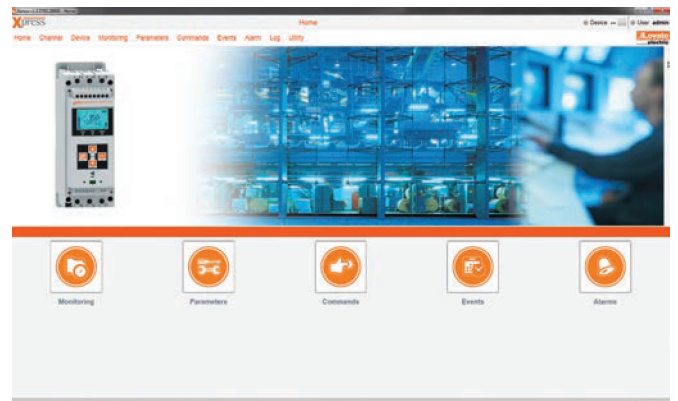

**Basic version
ADXNB... type**



ADXNB...

new

Order code	IEC rated starter current le	Rated motor power ≤40°C			Qty per pkg	Wt
		400V	400-480V	550-600V		
	[A]	[kW]	[HP]	[HP]	n°	[kg]

Parameters setting with potentiometers.
Built-in bypass relay and 2 relay outputs.
Rated operational voltage 208...600VAC
Auxiliary supply Us 100...240VAC.

ADXNB006	6	2.2	3	5	1	0.450
ADXNB012	12	5.5	7.5	10	1	0.450
ADXNB018	18	7.5	10	15	1	0.450
ADXNB025	25	11	15	20	1	0.630
ADXNB030	30	15	20	25	1	0.630
ADXNB038	38	18.5	25	30	1	0.660
ADXNB045	45	22	30	40	1	0.660

Auxiliary supply Us 24VAC/DC.

ADXNB00624	6	2.2	3	5	1	0.450
ADXNB01224	12	5.5	7.5	10	1	0.450
ADXNB01824	18	7.5	10	15	1	0.450
ADXNB02524	25	11	15	20	1	0.630
ADXNB03024	30	15	20	25	1	0.630
ADXNB03824	38	18.5	25	30	1	0.660
ADXNB04524	45	22	30	40	1	0.660

**NFC version
ADXNF... type**



ADXNF...



new

Order code	IEC rated starter current le	Rated motor power ≤40°C			Qty per pkg	Wt
		400V	400-480V	550-600V		
	[A]	[kW]	[HP]	[HP]	n°	[kg]

NFC connectivity for parameters setting with smartphone and App.

Built-in bypass relay and 2 relay outputs.
Rated operational voltage 208...600VAC
Auxiliary supply Us 100...240VAC.

ADXNF006	6	2.2	3	5	1	0.450
ADXNF012	12	5.5	7.5	10	1	0.450
ADXNF018	18	7.5	10	15	1	0.450
ADXNF025	25	11	15	20	1	0.640
ADXNF030	30	15	20	25	1	0.640
ADXNF038	38	18.5	25	30	1	0.670
ADXNF045	45	22	30	40	1	0.670

Auxiliary supply Us 24VAC/DC.

ADXNF00624	6	2.2	3	5	1	0.450
ADXNF01224	12	5.5	7.5	10	1	0.450
ADXNF01824	18	7.5	10	15	1	0.450
ADXNF02524	25	11	15	20	1	0.640
ADXNF03024	30	15	20	25	1	0.640
ADXNF03824	38	18.5	25	30	1	0.670
ADXNF04524	45	22	30	40	1	0.670

General characteristics

ADXN... is a soft starter with two phase control for the gradual control of the start and stop of asynchronous motors. Its main strengths are the simplicity of configuration, thanks to a short set of parameters which allows the programming simple and fast, and the compactness, thanks to the enclosure only 45mm wide which makes it suitable for the installation in panels with limited spaces.

It can be used for several applications such as the control of pumps, fans, compressors, conveyor belts and mixers. It is available with rated current from 6 to 45A, suitable for the installation in systems with rated line voltage from 208 to 600VAC 50/60Hz.

The series consists of 3 versions which differs in the type of programming mode (settings with potentiometers on front or via smartphone with NFC technology and App) and integrated functions.

Every version is available in double variant with auxiliary supply voltage 24VAC/DC or 100...240VAC to suit every need based on the voltage present in the plant.

BASIC VERSION ADXNB

The soft starter ADXNB is the ideal solution for those who need a soft starter with basic functions and extremely simple to configure. The configuration requires the settings of only 3 parameters adjusted with potentiometers present on the front of the soft starter.

The general characteristics are the following:

- Built-in bypass relay
- Programming with potentiometers on front: starting voltage, acceleration ramp and deceleration ramp
- Voltage ramp startup
- Free wheel or controlled stop
- Integrated overtemperature protection
- 2 built-in relay outputs with normally open NO contact, with function line contactor control (Run) and TOR (Top Of Ramp)
- Suitable for the control of pumps, fans, blowers, conveyor belts, compressors and general purpose applications.

NFC VERSION ADXNF

The soft starter ADXNF is a version provided with NFC connectivity for the programming via smartphone and LOVATO **NFC** App. The default settings make it ready to use for the control of scroll compressors, typically used in air conditioning systems, refrigerators and heating pumps but the parameters can be modified via smartphone and LOVATO **NFC** App for the control of every kind of application, like pumps, fans, conveyor belts, etc.

It is also possible to configure a password for the lock of the settings.

The general characteristics are the following:

- Built-in bypass relay
- Programming with smartphone with NFC technology and LOVATO **NFC** App, available for Android and iOS smart devices, freely downloadable from Google Play Store and App Store.
- Default settings with pre-configured parameters for the control of scroll compressors
- Voltage ramp startup
- Free wheel or controlled stop
- Integrated overtemperature protection
- 2 built-in relay outputs with normally open NO contact with programmable function line contactor control (Run), TOR-Top Of Ramp and alarm
- Suitable for the control of scroll compressors (air conditioning systems, refrigerators and heating pumps), pumps, fans, blowers, conveyor belts, compressors and general purpose applications with parameters settings via NFC connectivity and LOVATO **NFC** App.

Operational characteristics ADXN...

See page 5-7.

Certifications and compliance

5 Soft starter

Two phase control - ultra compact.
Accessories

Advanced version ADXNP... type



ADXNP...



new

Order code	IEC rated starter current le	Rated motor power $\leq 40^\circ\text{C}$			Qty per pkg	Wt
	[A]	400V	400-480V	550-600V	n°	[kg]
ADXNP006	6	2.2	3	5	1	0.470
ADXNP012	12	5.5	7.5	10	1	0.470
ADXNP018	18	7.5	10	15	1	0.470
ADXNP025	25	11	15	20	1	0.660
ADXNP030	30	15	20	25	1	0.660
ADXNP038	38	18.5	25	30	1	0.690
ADXNP045	45	22	30	40	1	0.690

Setting of basic parameters with potentiometers and advanced parameters with NFC connectivity and App. Integrated motor electronic thermal protection. Built-in bypass relay and 2 relay outputs. Built-in optical port on front. Optional RS485 Modbus-RTU module. Rated operational voltage 208...600VAC. Auxiliary supply Us 100...240VAC.

Order code	Description	Qty per pkg	Wt
		n°	[kg]
ADXNP00624	Auxiliary supply Us 24VAC/DC.	6	0.470
ADXNP01224		12	0.470
ADXNP01824		18	0.470
ADXNP02524		25	0.660
ADXNP03024		30	0.660
ADXNP03824		38	0.690
ADXNP04524		45	0.690

ADVANCED VERSION ADXNP

The soft starter ADXNP provides the motor electronic current thermal protection, obtained thanks to the presence of integrated current transformers, which allow the motor protection against overload and the management of starting ramps with current limiting, which are automatically adapted to follow the load variations. It is provided with both potentiometers on front for the setting of the basic parameters and NFC connectivity and optical port for the programming of the advanced parameters through the LOVATO **NFC** App. ADXNP can also be equipped with an optional RS485 communication module in order to be integrated in a supervision network.

The general characteristics are the following:

- Built-in bypass relay
- Integrated electronic thermal protection of the motor, with double class (starting and running) configurable
- Programming of basic parameters with potentiometers on front (which can be disabled via NFC if preferable): starting voltage, acceleration ramp and deceleration ramp
- Programming of advanced parameters (rated motor current, starting current limit, tripping thermal class, protection thresholds, communication parameters, password, relay outputs function and alarm properties) with smartphone with NFC technology and LOVATO **NFC** App, available for Android and iOS smart devices, freely downloadable from Google Play Store and App Store
- Voltage ramp startup with current limiting
- Free wheel or controlled stop
- Integrated overtemperature protection
- 2 built-in relay outputs with normally open NO contact with programmable function line contactor control (Run), TOR (Top Of Ramp), alarm and maximum torque
- Optical port on front for the connection of USB (CX01) or Wi-Fi (CX02) devices for programming, data download and diagnostic from PC with **Xpress** software or smart devices with LOVATO **Smart1** App, freely downloadable from Google Play Store and App Store
- Optional RS485 module (CX04), Modbus-RTU protocol
- Suitable for the control of pumps, fans, blowers, conveyor belts, compressors mixers and general purpose applications.

Operational characteristics ADXNP...

- Two phase control
- Input voltage: 208...600VAC $\pm 10\%$
- Network frequency: 50 or 60Hz $\pm 5\%$ self-configurable
- Auxiliary power supply Us: 24VAC/DC (ADXNP...24), 100...240VAC (ADXNP...) -15%/+10%
- Rated starter current le: 6...45A
- 3 indicator LEDs: presence of auxiliary power supply, ramp in progress / TOR, alarm
- 1 digital input for start command
- 2 relay outputs with normally open contact, programmable on ADXNF and ADXNP, fixed function on ADXNB
- Operating temperature: $-20...+60^\circ\text{C}$ (above 40°C with derating of the starter current)
- Storage temperature: $-30...+80^\circ\text{C}$
- Screw fixing or 35mm DIN rail mounting (IEC/EN/BS 60715)
- Protection degree: IP20.

Certifications and compliance

Certifications (pending): cULus, EAC, RCM. Compliant with standards: IEC/EN/BS 60947-1, IEC/EN/BS 60947-4-2, UL 60947-4-2, CSA C22.2 n° 60947-4-2.

Certifications and compliance for accessories

Certifications (pending): cULus (only for SM1X3150R and CX04), EAC. Compliant with standards: CX01: IEC/EN/BS 61010-1, IEC/EN/BS 61000-6-2, IEC/EN/BS 61000-6-3; CX02: IEC/EN/BS 60950-1, EN 62311, EN301 489-1 V2.2.0, EN 301 489-17 V3.2.0, EN300 328 V2.1.1. SM1X3150R: IEC/EN/BS 60947-1, UL 60947-4-2, CSA C22.2 n° 60947-4-2; CX04: IEC/EN/BS 61010-1, UL 61010-1, CSA C22.2 n° 61010-1.

Accessories for ADXNP... type



SM1X3150R



EXP8007

new

Order code	Description	Qty per pkg	Wt
		n°	[kg]

Accessories for soft starters ADXNP... type

SM1X3150R	Rigid connection for soft starters type ADXNP from 6 to 38 A for the direct mounting to a motor protection circuit breaker type SM1R	1	0.040
EXP8007	Fan for soft starters type ADXNP from 6 to 30 A for the increasing of number of operations per hour (ADXNP size 38 and 45A already have a built-in fan as standard)	1	0.030

For details about motor protection circuit breakers type SM1R refer to the chapter 1.

Communication devices for ADXNP... type



CX01



CX02



CX04

new

Order code	Description	Qty per pkg	Wt
		n°	[kg]
CX01	USB connection device PC ↔ ADXNP with optical connector for programming, data download, diagnostics and firmware update	1	0.090
CX02	Wi-Fi connection device PC/smartphone ↔ ADXNP for data download, programming and diagnostics	1	0.090
CX04	RS485 communication module for ADXNP, Modbus-RTU protocol. Auxiliary supply 24VAC/DC.	1	0.180

ADXL... types



ADXL0018600...ADXL0060600



ADXL0135600...ADXL0162600

Order code	IEC rated starter current I _e	Rated motor power ≤40°C IEC (400V)		Qty per pkg	Wt
	[A]	[kW]Ⓜ	[HP]	n°	[kg]

For standard and heavy-duty applications (starting current selectable from 3.5•I_e to 5.5•I_e).
With built-in bypass relay.
Rated operational voltage 208...600VAC.
Auxiliary supply U_s 100...240VAC.

ADXL0018600	18	7.5	10	1	2.100
ADXL0030600	30	15	15	1	2.100
ADXL0045600	45	22	25	1	2.100
ADXL0060600	60	30	30	1	2.100
ADXL0075600	75	37	40	1	2.900
ADXL0085600	85	45	50	1	2.900
ADXL0115600	115	55	60	1	2.900
ADXL0135600	135	75	75	1	7.800
ADXL0162600	162	90	75	1	7.800
ADXL0195600	195	110	100	1	13.900
ADXL0250600	250	132	150	1	13.900
ADXL0320600	320	160	200	1	13.900

IEC ratings ≤40°C (50Hz)

Order code	Rated starter current I _e	Rated motor power ①		
		230V	400V	500V
	[A]	[kW]	[kW]	[kW]
ADXL0018600	18	4	7.5	11
ADXL0030600	30	7.5	15	18.5
ADXL0045600	45	11	22	30
ADXL0060600	60	15	30	37
ADXL0075600	75	22	37	45
ADXL0085600	85	22	45	55
ADXL0115600	115	37	55	75
ADXL0135600	135	37	75	90
ADXL0162600	162	45	90	110
ADXL0195600	195	55	110	132
ADXL0250600	250	75	132	160
ADXL0320600	320	90	160	200

UL ratings ≤40°C (60Hz)

Order code	Rated starter current FLA	Rated motor power ②					
		208V	220-240V	380-415V	440-480V	550-600V	
	[A]	[HP]	[HP]	[HP]	[HP]	[HP]	
ADXL0018600	18	5	5	10	10	15	
ADXL0030600	28	10	10	15	20	25	
ADXL0045600	44	10	15	25	30	40	
ADXL0060600	60	20	20	30	40	50	
ADXL0075600	75	25	25	40	50	60	
ADXL0085600	83	25	30	50	60	75	
ADXL0115600	114	40	40	60	75	100	
ADXL0135600Ⓜ	130	40	50	75	100	125	
ADXL0162600Ⓜ	156	50	60	75	125	150	
ADXL0195600Ⓜ	192	60	75	100	150	200	
ADXL0250600Ⓜ	248	75	100	150	200	250	
ADXL0320600Ⓜ	320	100	125	200	250	300	

① Preferred rated values according to IEC/EN/BS 60072-1.
② Horsepower and current values according to UL508 (60Hz).
③ Terminal lug kits and shrouds are required for UL. See page 5-9.

General characteristics

The ADXL soft starter with two phase control and built-in bypass relay allows the control of the start and stop of three-phase asynchronous motors. ADXL is equipped with a backlit display with icons and NFC technology, for a simple, intuitive and fast configuration, with smartphones and tablets. ADXL is ideal for simple "plug and play" applications, thanks to the installation wizard, and for high-performance applications, with control and protection during the motor start-up and operation. The ADXL includes protection features for the starter and motor, and it's possible to enable specific alarms to signal maintenance needs, such as the number of startups performed or the operation hours of the motor.

It has the following main features:

- Backlit LCD display
- Texts available in 6 languages (ENG-ITA-FR-ES-POR-DE)
- IEC rated starter current I_e from 18 to 320A
- Rated motor current selectable from 50 to 100% of rated starter current I_e
- Rated motor power 7.5...160kW (400VAC) and 15...300HP (600VAC)
- Voltage or torque ramp startup
- Torque control
- Kick start
- Limited maximum starting current
- Free wheel or controlled stop
- 4 configurable sets of motor parameters
- Built-in bypass relay
- Optical port for programming, data download and diagnostics through the software Xpress and LOVATO Smart1 App, freely downloadable from Google Play Store and App Store
- NFC technology for parameter programming through the LOVATO NFC App, freely downloadable from Google Play Store and App Store
- Optional RS485 communication card
- Modbus-RTU and Modbus-ASCII communication protocols
- Supervision and energy management software Synergy.

Operational characteristics

- Two phase control
- Input voltage: 208...600VAC ±10%
- Network frequency: 50 or 60Hz ±10% self-configurable
- Auxiliary power supply: 100...240VAC
- 3 indicator LEDs: power supply, startup or bypass, alarm
- 3 programmable digital inputs, one of which configurable as digital or PTC input
- 3 programmable relay outputs: 1 with changeover contact and two with normally open contact
- Operating temperature: -20...+60°C (above 40°C with derating of the starter current by 0.5%/°C)
- Storage temperature: -30...+80°C
- Screw fixing or 35mm DIN rail mounting for ADXL0018600...ADXL0115600 with optional accessory EXP8003
- Protection degree: IP00
- Number of starts per hour: see page 5-20.

Displayed measures:

Maximum current, L1 current, L2 current, L3 current, torque, voltage, total active power, total PF, motor thermal status, soft starter temperature, energy, motor hour counter, number of starts.

Protections

- Motor: separate starting and running overload class settings thermal protection, PTC protection, locked rotor, current asymmetry, startup too long, minimum torque
- Power supply: no power supply, phase loss, wrong phase sequence and out-of-range frequency
- Starter: overtemperature, overcurrent, SCR fault, bypass relay fault, temperature sensor fault and fan fault.

Certifications and compliance

Certifications obtained: cULus, EAC, RCM. Compliant with standards: IEC/EN/BS 60947-1, IEC/EN/BS 60947-4-2, UL508, CSA C22.2 n°14.

Accessories for ADXL... types



CX01



CX02



EXCRDU1



EXC1042



EXCCON01



EXCM4G01



EXP8003



EXP8004



EXA01



EXA02



EXA03



EXA04

new

Order code	Description	Qty per pkg	Wt
		n°	[kg]
CX01	USB connection device PC ↔ ADXL with optical connector for programming, data download, diagnostics and firmware update	1	0.090
CX02	Wi-Fi connection device PC/smartphone ↔ ADXL for data download, programming, diagnostics and cloning	1	0.090
EXCRDU1	Remote keypad, LCD display with touchscreen, IP65 protection and NEMA 4X, 3m RS485 cable included supply 100...240VAC / 110...250VDC	1	0.360
EXC1042	RS485 communication card, Modbus-RTU protocol	1	0.020
EXCCON01	RS485/Ethernet converter, 12...48VDC, including DIN mounting guide kit	1	0.400
EXCM4G01	4G Gateway with RS485 and Ethernet port, Modbus RTU/TCP protocol	1	0.300
EXP8003	35mm DIN rail mounting accessory for ADXL0018600...ADXL0115600	1	0.200
EXP8004	Fan for ADXL0018600...ADXL0115600 (codes ADXL0075600...ADXL0115600 max of two EXP8004 fans)	1	0,040
EXA01	Kit of 3 UL terminal lugs for ADXL0135600, ADXL0162600, and ADXL0195600	1	0.141
EXA02	Kit of 3 terminals protection covers for ADXL0135600, ADXL0162600 and ADXL0195600	1	0.125
EXA03	Kit of 3 UL terminal lugs for ADXL0250600 and ADXL0320600	1	0.314
EXA04	Kit of 3 terminals protection covers for ADXL0250600 and ADXL0320600	1	0.154

General characteristics

Communication devices to connect LOVATO Electric products to:

- PC
- Smartphones
- Tablets.

CX01

This USB/optical device, complete with cable, allows the frontal connection of products compatible with PC with Xpress software without having to disconnect the power supply from the electric panel. The PC identifies the connection as a standard USB.

CX02

Via Wi-Fi connection, compatible LOVATO Electric products can be viewed on PCs, smartphones and tablets with no need for cabling. Compatible with Xpress software and LOVATO Sam1 App.

For dimensions, wiring diagrams and technical characteristics, consult the manuals available online in the Download section of the following website: www.LovatoElectric.com

EXCRDU1

Through the EXCRDU1 remote keypad, it is possible to command and monitor up to 32 starters at choice between soft starters ADXL series or variable speed drives VL3B series, even in mixed configuration.

For ADXL series is possible to set the parameters, command the start and stop of the motor, read the measures, signalling alarms and motor status.

- 100...240VAC / 110...250VDC power supply
- 128x112 pixel touchscreen LCD display
- Opto-isolated RS485 communication port, Modbus RTU protocol
- 96x96mm flush mount and ANSI 4"
- Compatible with ADXL equipped with communication card RS485, cod. EXC1042
- 3m/10ft long cable included
- Degree of protection IP65 and NEMA 4X.

EXCM4G01

For details please see section 31.

Certifications and compliance

Certifications obtained: cULus for EXA..., EXCRDU1, EXP8003 and EXP8004, EAC (except EXA...).

Compliant with standard:

- CX01 and EXCRDU1: IEC/EN/BS 61010-1, IEC/EN/BS 61000-6-2, IEC/EN/BS 61000-6-3;
- CX02: IEC/EN/BS 60950-1, EN 62311, EN 301 489-1 V2.2.0, EN 301 489-17 V3.2.0, EN 300 328 V2.1.1.
- EXC1042: IEC/EN/BS 60947-1, IEC/EN/BS 60947-4-2;
- EXCM4G01: IEC/EN/BS 60950-1.

51ADX... type



51ADX0017B...51ADX0045B



51ADX0060B...51ADX0085B



51ADX0110B...51ADX0125B

Order code	IEC rated starter current Ie	IEC rated motor power ≤40°C		Qty per pkg	Wt [kg]
		400V	380-415V		
	[A]	[kW]	[HP]	n°	

For standard duty (starting current 5•Ie).
With built-in bypass contactor.
Rated operational voltage 208...500VAC.
Auxiliary supply Us 208...240VAC.

51ADX0017B	17	7.5	7.5	1	8.970
51ADX0030B	30	15	15	1	9.240
51ADX0045B	45	22	25	1	9.240
51ADX0060B	60	30	30	1	14.200
51ADX0075B	75	37	40	1	14.400
51ADX0085B	85	45	50	1	14.400
51ADX0110B	110	55	60	1	17.700
51ADX0125B	125	55	60	1	17.700
51ADX0142B	142	75	75	1	28.000
51ADX0190B	190	90	100	1	37.300
51ADX0245B	245	132	150	1	39.300

For severe duty (starting current 5•Ie).
Predisposed for external bypass contactor.
Rated operational voltage 208...415VAC.
Auxiliary supply Us 208...240VAC.

51ADX0310	310	160	150	1	48.900
51ADX0365	365	200	200	1	49.300
51ADX0470	470	250	250	1	95.000
51ADX0568	568	315	350	1	95.000
51ADX0640	640	355	400	1	106.000
51ADX0820	820	400	500	1	164.000
51ADX1200	1200	710	900	1	234.000

General characteristics

51ADX is a three-phase control soft starter used to start and gradually stop three-phase asynchronous squirrel-cage motors. The startup can be performed through a voltage ramp with torque control and limitation of the maximum startup current. The integrated bypass contactor (only for 51ADX...B types) drastically limits dissipation, as a result, equipment for electric panel cooling ventilation can be eliminated and the enclosure size can be reduced as well. It's equipped with RS232 and RS485 interfaces.

CONTROL

- During starting: torque control acceleration, current limit control and booster.
- During stopping: torque control deceleration, dynamic braking and free-wheel.
- In emergency conditions: starting without protection direct-on-line starting using integrated bypass contactor.
- Remote control: PC supervision by connection with RS232/RS485 converter, analog modem or GSM modem.
- Automatic call function (Autocall) in case of alarm conditions with sending of SMS or e-mail.
- Proprietary ASCII and Modbus-RTU communication protocols.

FRONTAL KEYPAD FUNCTIONS

- Backlit LCD 2-line 16-character display
- 4 languages (Italian, English, French, Spanish)
- Basic, advanced and function programming menus
- Start and stop commands from keypad
- Measures readings:
 - line voltages (L-L)
 - phase currents
 - active and apparent power values per phase
 - power factor per phase
 - energy
- Events log
- Clock calendar with backup battery.

PARTICULAR FUNCTIONS

Digital inputs and programmable relay outputs.
Analog input (0...10V, 0...20mA or 4...20mA) for ramp acceleration and/or deceleration, motor start and stop control thresholds, programmable relay enable and disable control thresholds.
Analog output (0...10V, 0...20mA or 4...20mA) for current, torque, motor thermal status and power factor readings.
Input programming for second motor starting.

PROTECTIONS

- Motor: dual thermal protection class (one during starting phase and the other during running) or by PTC sensor, locked rotor, current asymmetry, minimum torque and starting time too long
- Auxiliary voltage: voltage value too low
- Power voltage: phase failure, phase sequence and frequency out of limits
- Control inputs and analog output: auxiliary 24VDC short-circuit protection with automatic resetting.
- Starter: overcurrent, high temperature, SCR and bypass contactor malfunction.

Operational characteristics

- Input voltage:
 - 208...500VAC ±10% (51ADX...B)
 - 208...415VAC ±10% (51ADX...)
- Network frequency: 50/60Hz ±5%
- Auxiliary supply voltage: 208...240VAC ±10%
- Auxiliary consumption: 20VA
- Rated starter current Ie:
 - 17A...245A (51ADX...B)
 - 310A...1200A (51ADX...)
- Motor current: 0.5...1 Ie
- Overload current:
 - 105% Ie for 51ADX...B
 - 115% Ie for 51ADX...
- Operating temperature: -10...+55°C (above 45°C with derating of the starter current by 1.5%/°C)
- Storage temperature: -30...+70°C.

Certifications and compliance

Certifications obtained: EAC.
Compliant with standard: IEC/EN/BS 60947-1, IEC/EN/BS 60947-4-2.

Accessories for 51ADX... types



51ADXTAST



51C4

Order code	Description	Qty per pkg	Wt
		n°	[kg]
51ADXTAST	Remote keypad 96x96mm, 2x16 backlit LCD, 208...240VAC supply, provided with 51C8 3m/10ft long connecting cable	1	0.350
31PA96X96	Protective cover (IP54) for remote keypad 51ADXTAST	1	0.076
51C2	PC (RS232) ↔ 51ADX connecting cable, 1.8m/6ft long	1	0.062
51C4	PC (RS232) ↔ RS232/RS485 converter drive connecting cable, 1.8m/6ft long	1	0.147
51C6	51ADX ↔ RS232/RS485 converter drive connecting cable, 1.8m/6ft long	1	0.102
51C8	51ADX ↔ 51ADXTAST remote keypad connecting cable, 3m/10ft long	1	0.080

51ADXTAST remote keypad

The flush-mount 51ADXTAST remote keypad is identical to the one integrated on the front of the soft starter except for the start and stop commands of the motor which are permanently disabled.

With this keypad it is possible to configure the setup of the soft starter, read measures and operating data and transfer the parameters from 51ADX to the keypad and vice versa. A backup copy of the soft starter data and parameter setup is obtainable with the transfer functions.

It is possible to adjust the display contrast and the backlight and select the communication baud rate.

The 51C8 cable 3m/10ft long provided with the keypad is used to connect the 51ADXTAST keypad to the RS485 port of the 51ADX soft starter.

For longer distances the keypad can be connected to the RS232 port of the 51ADX soft starter with RS232/RS485 converter.

Operational characteristics

- Auxiliary supply voltage: 208...240VAC ±10% 50/60Hz
- Power consumption: 6.9VA
- Dissipation: 3.2W
- RS485 port: RJ4/4 connector
- Supply: Removable 3-pole 2.5 mm² terminal block.
- Display: 2 line, 16 character backlit LCD
- LED indication (3): POWER, RUN and FAULT
- Keys (6) ENTER/START, RESET/STOP, ←PREVIOUS, NEXT→, ▼ and ▲
- Ambient conditions:
 - Operating temperature: -10...+60°C
 - Storage temperature: -20...+70°C
- Flush mount enclosure
- Degree of protection on front: IP41; IP54 with protective cover (code 31PA96x96).

Certifications and compliance for 51ADXTAST

Certifications obtained: EAC.

Compliant to standards: IEC/EN/BS 60947-1, IEC/EN/BS 60947-4-2.

Remote control software 51ADXSW

The soft starters 51ADX... can be connected to a PC for the control and supervision with the software 51ADXSW:

- Parameters setup, with possibility to save the settings on the PC and subsequently reload them on the soft starter
- Display of all the measures of the soft starter (current, torque, etc.) in real time
- Access to all the functions of the frontal panel with a virtual keypad with possibility to operate on the pushbuttons
- Graphic trends of monitored parameter data during operation
- Display of soft starter events log showing time and date entry.

The connection between 51ADX and PC is made by the supplied 51C2 cable via the RS232 port, RS232/RS485 converter, analog or GSM modem.

GSM modem represents the ultimate solution for unmanned applications or where there are no telephone lines, with possibility to send messages via SMS and email in case of alarm.

The software is available in 4 languages (Italian, English, Spanish and French) and it is freely downloadable from the Download section of the website www.LovatoElectric.com.

For ADXNP... and ADXL...

Xpress configuration and remote control software



Synergy supervision and energy management software



LOVATO **Sam1** APP



For ADXNF... , ADXNP... and ADXL...

LOVATO **NFC** APP



Xpress

By using the **Xpress** software, the quick setup of the soft starter can be carried out via PC, avoiding possible parameter programming errors.

The parameter programming of ADXNP... and ADXL... soft starters can also be PC saved and quickly uploaded other devices of the same model requiring the same programming.

It allows the following operations:

- Graphical and numerical display of measurements
- Soft starter status monitoring
- Access all setup parameters
- Saving / loading parameters
- Highlighting of changed values
- Resetting to default values
- Send commands
- See live trends
- Reading of events list.

Xpress software is freely downloadable from the website www.LovatoElectric.com, section Energy Management.

Synergy

Synergy software allows to remotely control and monitor the soft starters. The software structure and applications are based on MS SQL relational databases and the data can be consulted via the most common browsers. It is an extremely versatile system that can be accessed via intranet network, VPN or internet by several users/units at the same time.

For details, consult section 30 or our Technical support office; see contact details on inside front cover.

Sam1 APP for smartphones and tablets

The application **Sam1** allows the user to set the soft starter, view the alarms, send commands, read the measures, download the events and submit the data collected via e-mail. The connection is made by Wi-Fi with a smartphone or tablet using the CX02 device.

The App is compatible with Android and iOS smart devices and it is freely downloadable from Google Play Store and App Store.

For details, consult section 30 or our Technical support office; see contact details on inside front cover.

NFC APP for smartphones and tablets

The soft starters ADXNF..., ADXNP... and ADXL... are equipped with built-in NFC technology. Using the LOVATO **NFC** App it is possible to program the parameters and save them on smartphones and tablets.

The App is compatible with Android and iOS smart devices and it is freely downloadable from Google Play Store and App Store.

For details, consult section 30 or our Technical support office; see contact details on inside front cover.

5 Soft starters

Dimensions [mm (in)]

SOFT STARTER

ADXN...006... - ADXN...018...

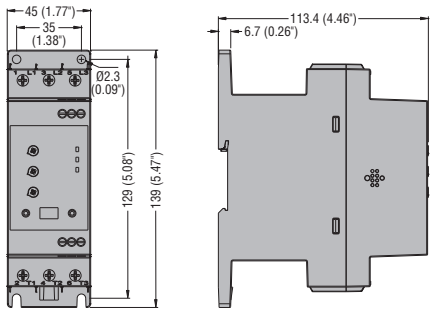

ADXNP006... - ADXNP018... with CX04 RS485 communication module.

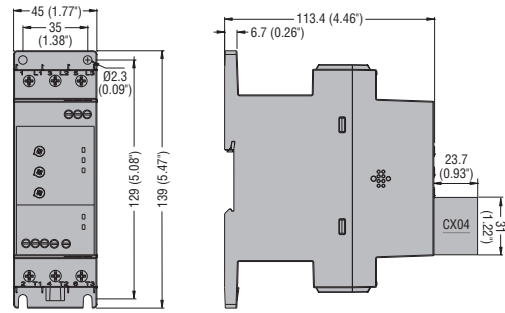

ADXN...025... - ADXN...045...

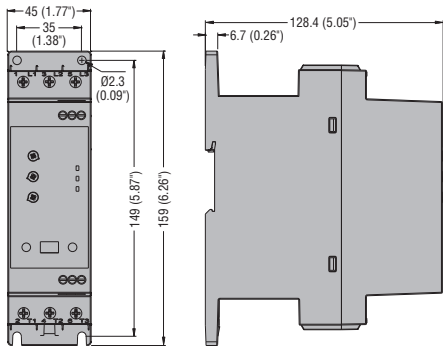

ADXNP025... - ADXNP045... with CX04 RS485 communication module.

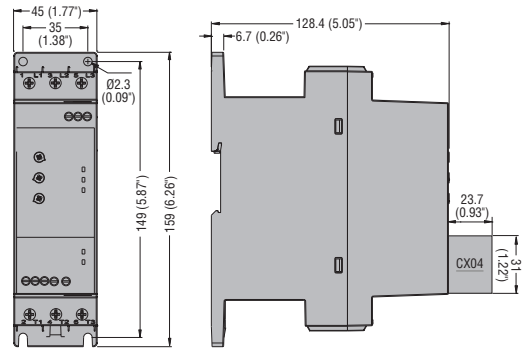

ADXL0018600...ADXL0060600

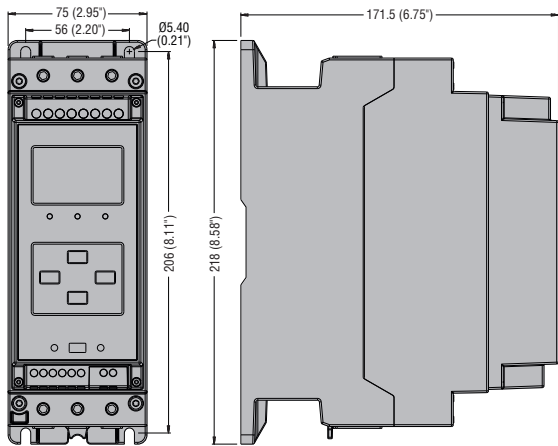

ADXL0075600...ADXL0115600

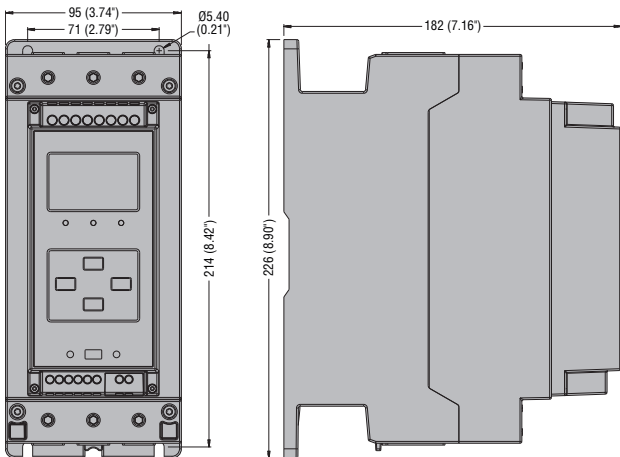

5 Soft starters

Dimensions [mm (in)]

ADXL0135600 - ADXL0162600

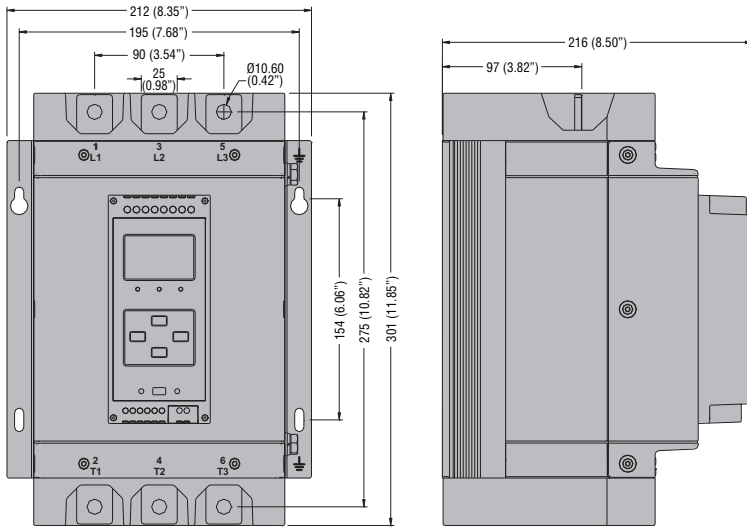

ADXL0135600 - ADXL0162600 complete with terminal lugs for UL code EXA01 and terminals protection code EXA02.

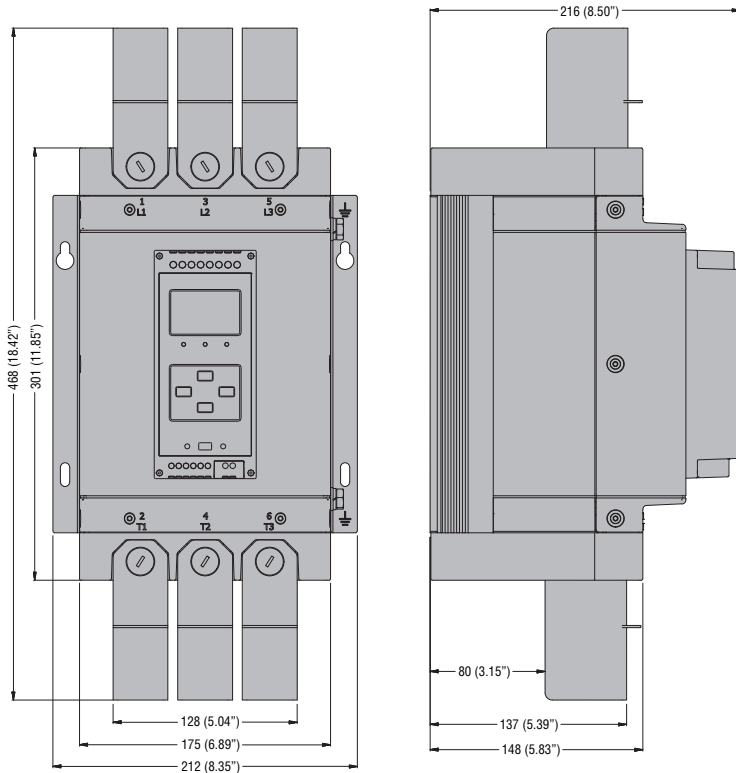

5 Soft starters

Dimensions [mm (in)]

ADXL0195600...ADXL0320600

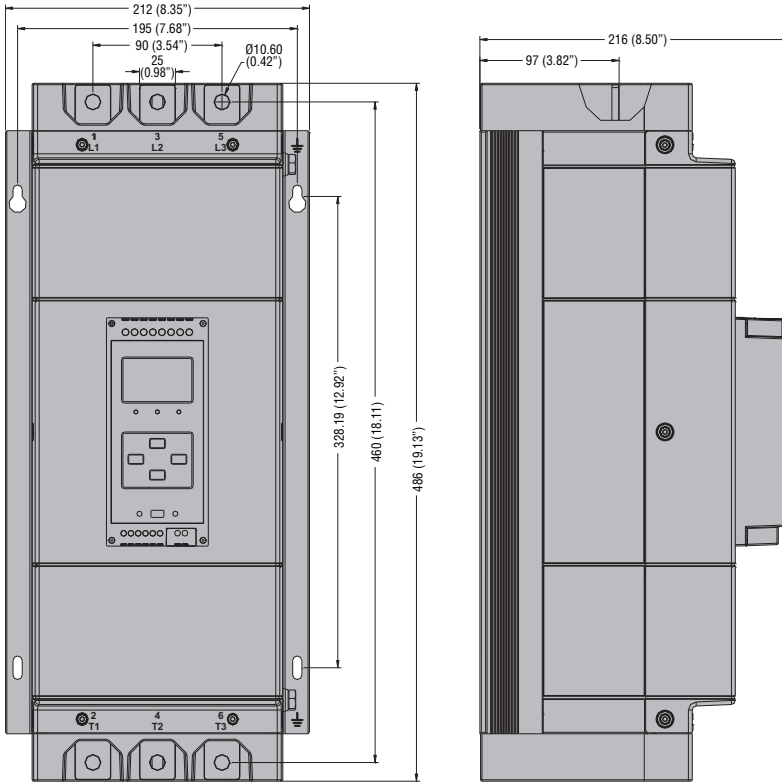

ADXL0195600 complete with terminal lugs for UL code EXA01 and terminals protection code EXA02.
ADXL0250600 - ADXL0320600 complete with terminal lugs for UL code EXA03 and terminals protection code EXA04.

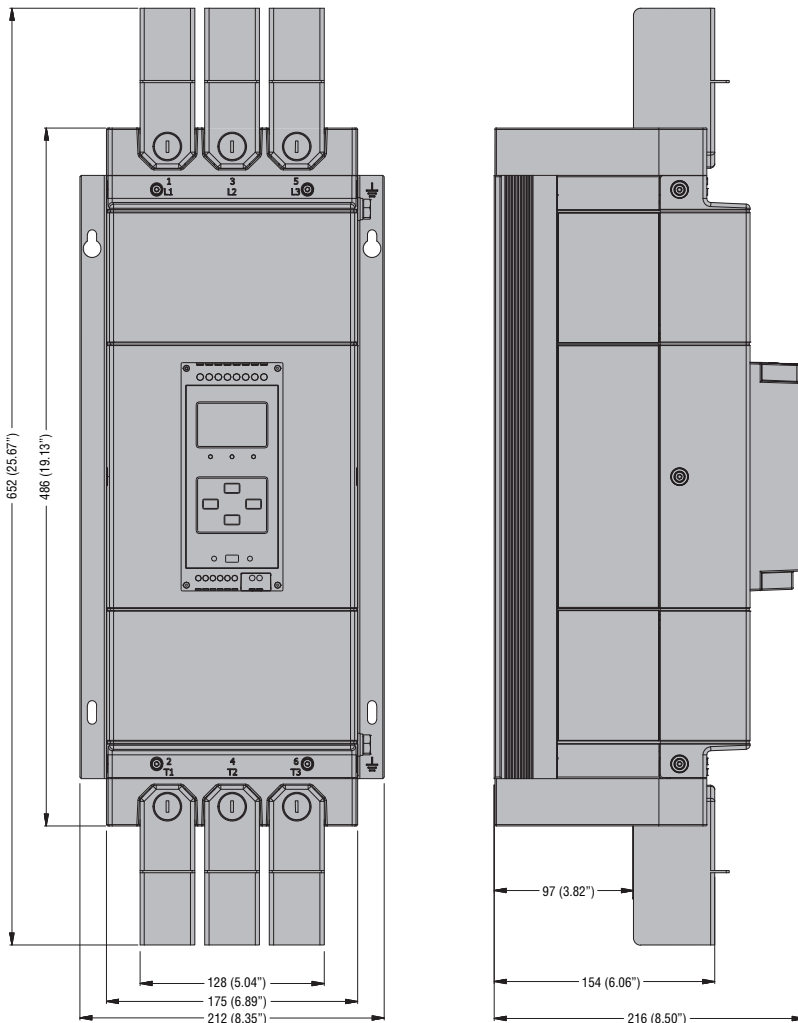

5 Soft starters

Dimensions [mm (in)]

51ADX0017B...51ADX0125B

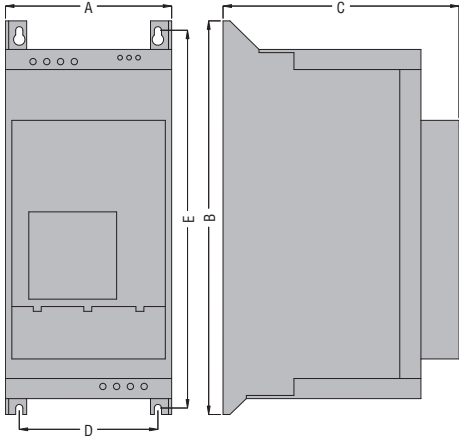

TYPE	A	B	C	D	E
51ADX0017B	157 (6.18")	372 (14.64")	223 (8.78")	131 (5.16")	357 (14.05")
51ADX0030B	157 (6.18")	372 (14.64")	223 (8.78")	131 (5.16")	357 (14.05")
51ADX0045B	157 (6.18")	372 (14.64")	223 (8.78")	131 (5.16")	357 (14.05")
51ADX0060B	157 (6.18")	534 (21.02")	250 (9.84")	132 (5.20")	517 (20.35")
51ADX0075B	157 (6.18")	534 (21.02")	250 (9.84")	132 (5.20")	517 (20.35")
51ADX0085B	157 (6.18")	534 (21.02")	250 (9.84")	132 (5.20")	517 (20.35")
51ADX0110B	157 (6.18")	584 (22.99")	250 (9.84")	132 (5.20")	567 (22.32")
51ADX0125B	157 (6.18")	584 (22.99")	250 (9.84")	132 (5.20")	567 (22.32")

51ADX0142B...51ADX0245B

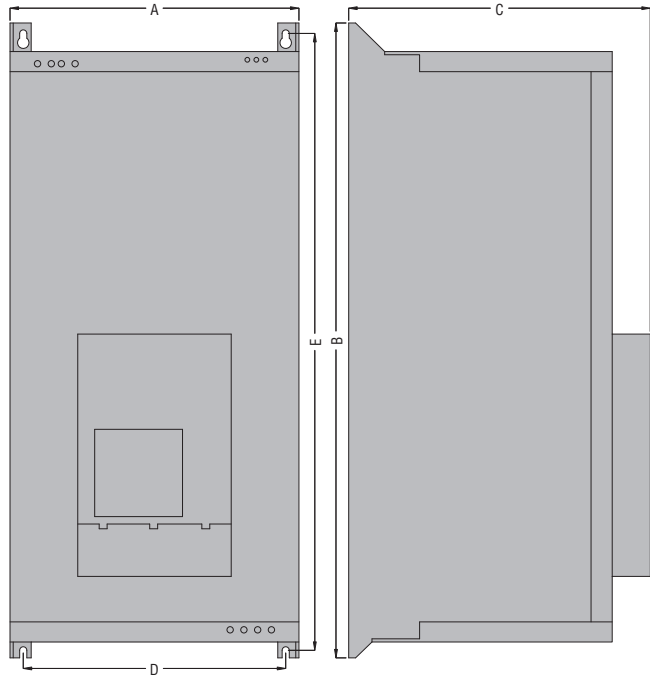

TYPE	A	B	C	D	E
51ADX0142B	273 (10.75")	600 (23.62")	285 (11.22")	230 (9.05")	560 (25.20")
51ADX0190B	273 (10.75")	680 (26.77")	310 (12.20")	230 (9.05")	640 (25.20")
51ADX0245B	273 (10.75")	680 (26.77")	310 (12.20")	230 (9.05")	640 (25.20")

51ADX0310...51ADX1200

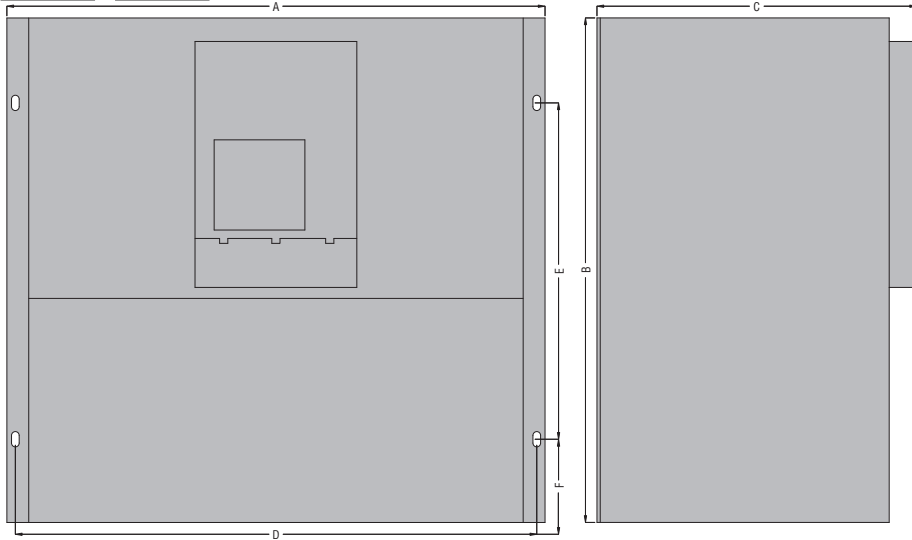

TYPE	A	B	C	D	E	F
51ADX0310	640 (25.20")	600 (23.62")	380 (14.96")	620 (24.41")	400 (15.75")	100 (3.94")
51ADX0365	640 (25.20")	600 (23.62")	380 (14.96")	620 (24.41")	400 (15.75")	100 (3.94")
51ADX0470	790 (31.10")	650 (25.59")	430 (16.93")	770 (30.31")	450 (17.72")	100 (3.94")
51ADX0568	790 (31.10")	650 (25.59")	430 (16.93")	770 (30.31")	450 (17.72")	100 (3.94")
51ADX0640	790 (31.10")	650 (25.59")	430 (16.93")	770 (30.31")	450 (17.72")	100 (3.94")
51ADX0820	910 (35.83")	950 (37.40")	442 (17.40")	830 (32.68")	920 (36.22")	⓪
51ADX1200	910 (35.83")	950 (37.40")	442 (17.40")	830 (32.68")	920 (36.22")	⓪

⓪ Consult Technical support; see contact details on inside front cover.

ACCESSORIES

EXCRDU1

Cutout

51ADXTAST

Cutout

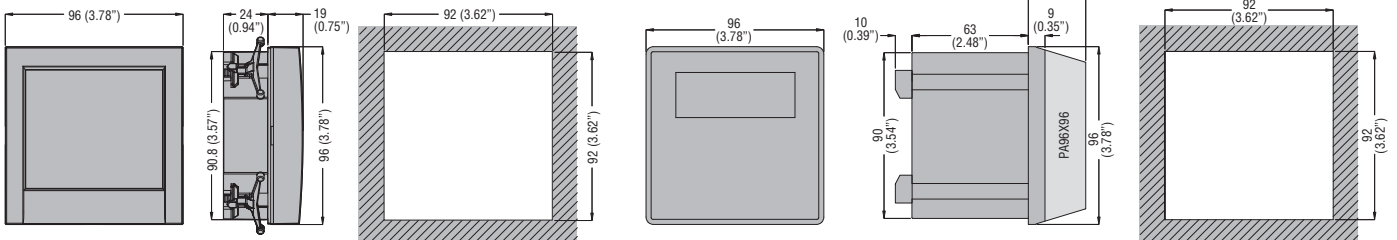

5 Soft starters

Wiring diagrams

ADXN...

Switch disconnector + fuses + contactor, control by switch (type 0-1)

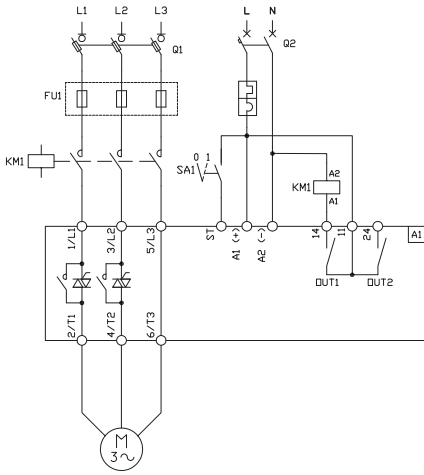

Switch disconnector + fuses + contactor + thermal overload relay, control by switch (type 0-1)

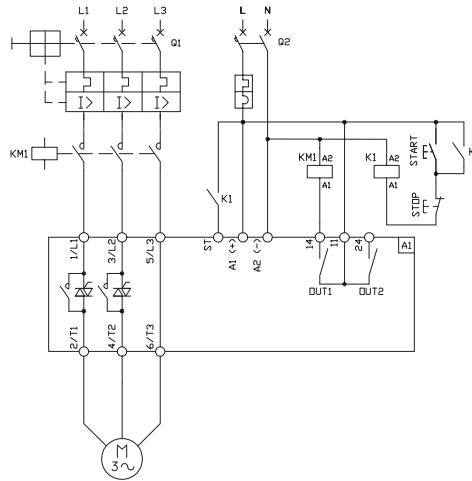

MPCB + contactor, control by switch (type 0-1)

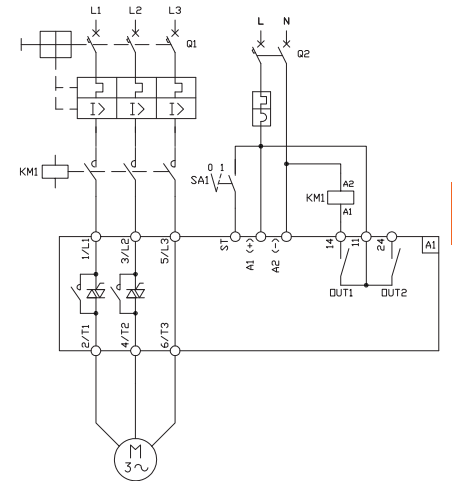

MPCB + contactor, control by pushbuttons

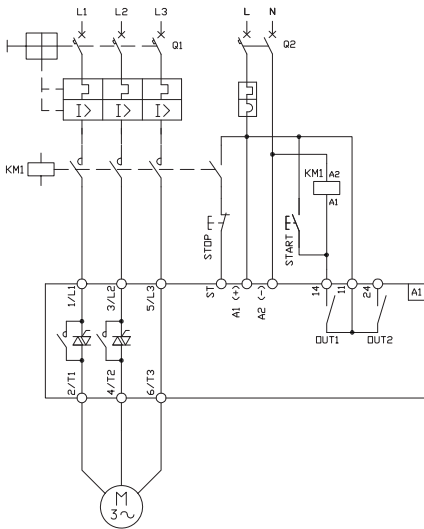

ADXL...

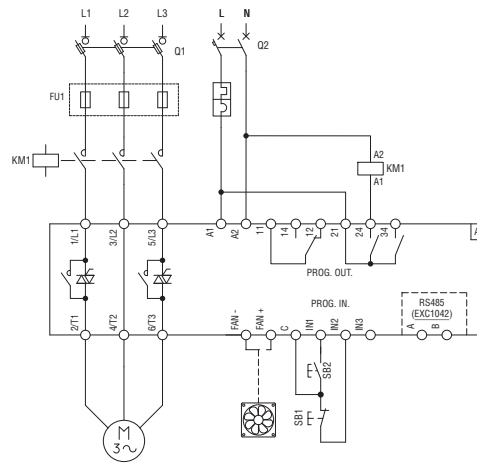

51ADX...B

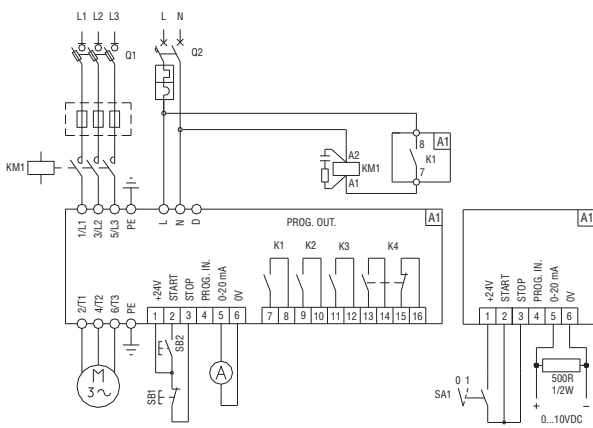

51ADX...

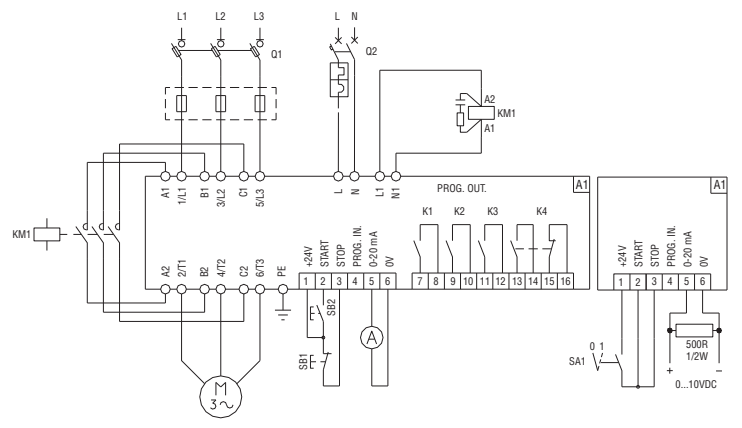

5 Soft starters

Technical characteristics ADXN... types

TYPE (with 2 controlled phases)		ADXNB...	ADXNF...	ADXNP...
Motor	Type	Asynchronous three phase		
	Power	1.1...11kW (230VAC), 2.2...22kW (400VAC), 3...30kW (500VAC) 1.5...15HP (220-240VAC), 3...30HP (440-480VAC), 5...40HP (550-600VAC)		
	Rated current	6...45A		
Supply voltage	Line voltage	208...600VAC ±10%		
	Auxiliary supply voltage Us	100...240VAC for ADXN..., 24VAC/DC for ADXN...24 -15%/+10%		
	Frequency	50 or 60Hz ±5% self-configurable		
Bypass relay		Integrated		
Cooling system	Natural	ADXN...006... - ADXN...030...		
	Forced	ADXN...038... - ADXN...045..., optional for ADXN...006... - ADXN...030...		
Number of starts per hour		❶		
PROTECTIONS				
Line voltage		Lack of line voltage, phase loss, frequency out of limits, wrong phase sequence		
Motor		-	-	Electronic current thermal protection (overload), locked rotor, current asymmetry, load too low, starting too long
Soft starter		Overtemperature	Overtemperature	Overcurrent and overtemperature
STARTUP AND STOP SETTINGS				
Startup		Voltage ramp	Voltage ramp	Voltage ramp with current limit
Stop		Voltage ramp or free-wheel stop		
Braking		-		
PROGRAMMING INTERFACES				
Potentiometers		Settings: starting voltage, acceleration ramp time, deceleration ramp time	-	Settings: starting voltage, acceleration ramp time, deceleration ramp time. Note. The potentiometers can be disabled via NFC.
NFC connectivity		-	Settings: starting voltage, acceleration ramp time, deceleration ramp time, protection thresholds, password, relay outputs function and alarm properties	Settings: rated motor current, starting current limit, thermal protection class, protection thresholds, communication parameters, password, relay outputs function and alarm properties
Optical port		-	-	Connection with USB device CX01 for the connection to a PC with Xpress software. Connection to Wi-Fi device CX02 for the connection to a PC with Xpress software or Android and iOS smartphone and tablet with LOVATO SAM1 App. Connection of the RS485 communication module CX04, Modbus-RTU protocol.
LEDs		3: POWER (presence of auxiliary power supply), RUN (run/Top Of Ramp), ALARM (alarm, with identification of the type of active alarm with number of flashes of the LED)		
DIGITAL INPUT ST (start)				
Input type		Volt-free contact		
Input function		Motor start		
RELAY OUTPUTS				
Number of outputs		2		
Outputs arrangement		2 NO contacts with the same common, 5A 250VAC AC1 – 5A 30VDC		
Outputs functions		Line contactor (run), TOR (Top Of Ramp)	Programmable: Line contactor (run), TOR (Top Of Ramp), alarm	Programmable: Line contactor (run), TOR (Top Of Ramp), alarm, max torque
COMMUNICATION				
RS485 port		-	-	Optional, with communication module CX04 (RS485, Modbus-RTU protocol)
AMBIENT CONDITIONS				
Operating temperature		-20...+60°C (above 40°C with derating of the starter current❶)		
Storage temperature		-30...+80°C		
Relative humidity		<80%		
Maximum altitude		1000m without derating of the starter current		
Pollution degree		2		
Overvoltage category		III		
Operating position		Vertical		
HOUSING				
Mounting		Screw fixing or mounting on 35mm DIN rail (IEC/EN/BS 60715)		
IEC degree of protection		IP20		

❶ Consult Technical support for information; see contact details on inside front cover.

5 Soft starters

Technical characteristics ADXL... types

TYPE (with 2 controlled phases)		ADXL...600
Motor	Type	Asynchronous three phase
	Power	7.5...160kW (400VAC) 15...300HP (550...600VAC)
	Rated current	18...320A (the value can be set between the 50% and 100% of the rated soft starter current Ie)
Supply voltage	Line voltage	208...600VAC ±10%
	Auxiliary supply voltage Us	100...240VAC±10%
	Frequency	50 or 60Hz ±5% self-configurable
Cooling system	Natural	ADXL0018600...ADXL0115600
	Forced	ADXL0135600...ADXL0320600 Optional for ADXL0018600...ADXL0115600
Number of starts per hour	See table at page 5-20	
PROTECTIONS		
Auxiliary supply	Voltage too low	
Line voltage	Lack of line voltage, phase loss, frequency out of limits, minimum and maximum voltage and phase sequence	
Motor	Overload at starting (trip class 2, 10A, 10, 15, 20, 25, 30, 35 and 40), overload during running (trip class 2, 10A, 10, 15, 20, 25 and 30), locked rotor, current asymmetry, minimum torque and starting too long	
Soft starter	Overcurrent and overtemperature	
STARTUP AND STOP SETTINGS		
Startup	Torque ramp with current limit, voltage ramp with current limit	
Stop	Torque ramp, voltage ramp or free-wheel stop	
Braking	—	
DISPLAY AND PROGRAMMING		
	Using the built-in keyboard and display, PC with CX01 and CX02 with software Xpress, smartphone or tablet with LOVATO NFC App or LOVATO SAM1 App with CX02 and remote display unit EXCRDU1 with EXC1042	
Display	Backlit icon LCD display	
Measure view	Maximum current, L1 current, L2 current, L3 current, torque, line voltage, total PF, motor thermal status, starter temperature, active power, active energy, motor hour counter, startup counter	
Other views	Operational status, events, alarms, measures	
LEDs	3: POWER (presence of auxiliary power supply), RUN (run/bypass), ALARM (alarm)	
DIGITAL INPUTS		
Number of inputs	3	
Input type	2 digital inputs with volt-free contact, 1 input configurable as digital input with volt-free contact or PTC input	
Inputs function	OFF, motor start, motor stop, free-wheel stop, motor preheating, local control, alarm inhibition, thermal status reset, keyboard lock, motor selection, user alarm, command, alarm reset	
RELAY OUTPUTS		
Number of outputs	3	
Output arrangement	- 2 NO: 3A 250VAC AC1 - 3A 30VDC - 1 changeover: NO contact 5A 250VAC AC1 - 5A 30VDC; NC contact 3A 250VAC AC1 - 3A 30VDC	
Outputs function	OFF, line contactor, run (ramp completed), global alarm, limits, remote variable, alarm	
COMMUNICATION INTERFACES		
	NFC, front optical port, optional RS485 (EXC1042)	
VARIOUS FUNCTIONS		
Calendar clock	—	
Event memory	60	
Operational data memory	Energy meter, startup counter, motor hour meter and maintenance hour counter	
AMBIENT CONDITIONS		
Operating temperature	-20...+60°C (above 40°C with derating of starter current of 0.5%/°C)	
Storage temperature	-30°...+80°C	
Maximum altitude	1000m (higher up with derating of starter current of 0.5%/100mt)	
Pollution degree	2	
Operating position	Vertical ±15°	
HOUSING		
Mounting	Screw-mount on panel or 35mm DIN rail (IEC/EN/BS 60715) with EXP8003 accessory for ADXL0018600...ADXL0115600	
IEC degree of protection	IP00	

5 Soft starters

Technical characteristics ADXN... - ADXL... types



NUMBER OF STARTS PER HOUR ADXN... TYPES

The following data are based on an ambient temperature of 40°C, starting current of 4*In and ramp time 6 seconds. In=Rated motor current.

In	NUMBER OF STARTS PER HOUR WITHOUT FAN																			
	5	10	15	20	25	30	35	40	45	50	55	60	65	70	75	80	85	90	95	100
3A	ADXN006																			
6A	ADXN006												ADXN012							
9A	ADXN012										ADXN018									
12A	ADXN012 - ADXN018																			
18A	ADXN018			ADXN025			ADXN030													
25A	ADXN025			ADXN030																
30A	ADXN030																			
38A																				
45A	ADXN038... and ADXN045... have built-in fan																			

In	NUMBER OF STARTS PER HOUR WITH FAN																			
	5	10	15	20	25	30	35	40	45	50	55	60	65	70	75	80	85	90	95	100
3A	ADXN006																			
6A	ADXN006												ADXN012							
9A	ADXN012										ADXN018									
12A	ADXN012										ADXN018									
18A	ADXN018										ADXN025					ADXN030				
25A	ADXN025										ADXN030									
30A	ADXN030										ADXN038					ADXN045				
38A	ADXN038										ADXN045									
45A	ADXN045																			

NUMBER OF STARTS PER HOUR ADXL... TYPES

The following data are based on an ambient temperature of 40°C, starting current of 4*In and ramp time 6 seconds. In=Rated motor current.

In	NUMBER OF STARTS PER HOUR WITHOUT FAN																			
	5	10	15	20	25	30	35	40	45	50	55	60	65	70	75	80	85	90	95	100
16A	ADXL0018600										ADXL0030600									
30A	ADXL0030600										ADXL0045600					ADXL0060600				
37A	ADXL0045600										ADXL0075600									
45A	ADXL0045600					ADXL0060600					ADXL0075600					ADXL0085600				
60A	ADXL0060600					ADXL0075600					ADXL0085600					ADXL0115600				
66A	ADXL0075600					ADXL0085600					ADXL0115600									
75A	ADXL0075600					ADXL0085600					ADXL0115600									
85A	ADXL0085600					ADXL0115600														
97A	ADXL0115600																			
115A	ADXL0115600																			
135A	ADXL0135600...ADXL0320600 have two integrated fans as standard																			
162A																				
195A																				
250A																				
320A																				

In	NUMBER OF STARTS PER HOUR WITH FAN																			
	5	10	15	20	25	30	35	40	45	50	55	60	65	70	75	80	85	90	95	100
16A	ADXL0018600										ADXL0030600									
30A	ADXL0030600										ADXL0045600					ADXL0060600				
37A	ADXL0045600										ADXL0075600									
45A	ADXL0045600										ADXL0060600					ADXL0075600				
60A	ADXL0060600										ADXL0075600					ADXL0085600				
66A	ADXL0075600										ADXL0085600					ADXL0115600				
75A	ADXL0075600										ADXL0085600					ADXL0115600				
85A	ADXL0085600										ADXL0115600					ADXL0135600				
97A	ADXL0115600										ADXL0135600					ADXL0162600				
115A	ADXL0115600										ADXL0135600					ADXL0162600				
135A	ADXL0135600										ADXL0162600					ADXL0195600				
162A	ADXL0162600										ADXL0195600					ADXL0250600				
195A	ADXL0195600										ADXL0250600					ADXL0320600				
250A	ADXL0250600					ADXL0320600														
320A	ADXL0320600																			

5 Soft starters

Technical characteristics 51ADX... types

TYPE (with 3 controlled phases)		51ADX...B (with integrated bypass contactor)	51ADX... (predisposed for external bypass contactor)
Motor	Type	Asynchronous three phase	
	Power	7.5...132kW (400VAC)	160...710kW (400VAC)
	Rated current	17...245A	310...1200A
Supply voltage	Line voltage	208...500VAC ±10%	208...415VAC ±10%
	Auxiliary supply voltage Us	208...240VAC ±10%	208...240VAC ±10%
	Frequency	50 or 60Hz ±5% self-configurable	
Cooling system	Natural	51ADX0017...45B	—
	Forced	51ADX0060...245B	All types
PROTECTION			
Auxiliary supply	Voltage too low		
Line voltage	Phase loss, frequency out of limits, minimum and maximum voltage and phase sequence		
Motor	Overload at starting (trip class 2, 10A, 10, 15, 20, 25, 30, 35, and 40), overload during running (trip class 2, 10A, 10, 15, 20, 25 and 30), locked rotor, current asymmetry, minimum torque and maximum starting time		
Soft starter	Overcurrent and overtemperature		
Inputs and outputs	Protection against auxiliary 24VDC short-circuit		
STARTUP AND STOP SETTINGS			
Startup	Torque ramp with maximum current control		
Stop	Free-wheel or deceleration ramp with torque control		
Braking	DC dynamic with external contactor		
DISPLAY AND PROGRAMMING			
	Integrated keypad on front, remote keypad 51ADXTAST or PC with software 51ADXSW		
Display	Backlit LCD 2x16 character		
Selectable languages	Italian, English, French, Spanish		
Measure view	Voltage, current, torque, power (kVA, kW), PF, thermal status of motor and starter, energy consumption		
Other views	Operating status, events, alarms, event log, data		
LEDs	"POWER", "RUN" and "FAULT"		
DIGITAL AND ANALOGUE INPUTS			
Number of inputs	3 (2 digital + 1 digital/analog)		
Input type	Volt-free contact (24VDC command provided by the soft starter)		
Inputs with fixed functions	2 inputs for starting and stopping/reset		
Multifunction input PROG.IN configured as digital input	Free-wheel stop, external alarm, motor preheat, local control, alarm inhibition, thermal protection, manual reset, cascade starting and keypad lock		
Multifunction input PROG.IN configured as analog input	Motor protection via PTC probe, acceleration and/or deceleration ramp via analog input, analog input thresholds for motor starting and stopping, analog input thresholds for programmable relay enable and disable, PT100 input thresholds for motor starting and stopping and PT100 input thresholds for programmable relay enable and disable		
RELAY OUTPUTS			
Number of outputs	4		
Output arrangement	1NO+1NC (global alarm) and 3 NO programmable: 5A 250VAC AC1		
Outputs function	Motor running, motor started, braking, current threshold triggering, maintenance schedule, cascaded startup, PROG-IN thresholds, alarm		
ANALOG OUTPUT			
Type	0...20mA, 4...20mA or 0...10V (with external 500Ω resistor)		
Associated measure	Current, torque, motor thermal status, power factor and active power		
COMMUNICATION INTERFACES			
RS232	Setup and remote control		
RS485	Dedicated only for the connection of 51ADXTAST remote keypad		
VARIOUS FUNCTIONS			
Calendar clock	Calendar clock with backup battery		
Event memory	20 sequential storing of alarms/events with date and time		
Operational data memory	Energy meter, startup counter, motor hour meter and maintenance hour counter		
AMBIENT CONDITIONS			
Operating temperature	-10...+55°C (above 45°C, with derating of the starter current of 1.5%/°C)		
Storage temperature	-30°...+70°C		
Pollution degree	3		
Maximum altitude	1000m (higher up with derating of the starter current of 0.5%/100mt)		
Operating position	Vertical ±15°		
HOUSING			
Mounting	Screw-mount on panel		
IEC degree of protection	IP00		

① IEC IP20 for 51ADX0017B...51ADX0125B types only.



- Versions with single-phase input up to 2.2kW / 3HP and three-phase input up to 110kW / 150HP
- Special function for pump and fan control using PID algorithm
- EMC suppressor included in all versions
- Selectable motor control mode: V/f, vector, energy saving
- Selectable digital and analog input and output functions
- Integrated functions for motor protection.

Variable speed drives

	SEC. - PAGE
VLA1 series (single-phase type)	6 - 3
VT1 series (single-phase ultra-compact type with RS485)	6 - 4
VLB3 series (three-phase type)	6 - 5

Accessories

Three-phase inductances	6 - 7
Braking resistors	6 - 7
Other accessories	6 - 7

Dimensions	6 - 8
-------------------------	--------------



Page 6-3

VLA1... SERIES

- Single-phase 200...240VAC supply
- Three-phase motor power 0.25...2.2kW / 0.33...3HP ratings at 240VAC
- Compliant with standard IEC/EN/BS 61800-3 cat.C2 without external filters
- Optional USB module for parameter programming.
- “Book style” housing.



Page 6-4

VT1... SERIES

- Single-phase 200...240VAC supply
- Three-phase motor power 0.2...2.2kW / 0.25...3HP ratings at 240VAC
- Compliant with standard IEC/EN/BS 61800-3 cat.C2 without external filters
- Built-in RS485 port, Modbus-RTU protocol and BACnet.
- Ultra-compact.



Page 6-5

VLB3... SERIES

- Three-phase 400...480VAC supply
- Three-phase motor power 0.4...110kW / 0.5...150HP for heavy load, up to 132kW / 175HP for standard load, ratings at 400VAC
- Compliant with standard IEC/EN/BS 61800-3 cat.C1 or cat.C2 without external filters
- Integrated dynamic braking circuit
- Optional STO (Safe Torque Off) module
- Optional three-phase motor inductances
- Optional braking resistors
- Communication protocols available: Modbus-RTU, CANopen, Profibus, Profinet and Ethercat
- Optional USB and Wi-Fi modules for parameter programming.
- “Book style” housing.

VLA1 series



VLA1...

Order code	Output current	3-phase motor power at 240VAC		Qty per pkg	Weight
	[A]	[kW]	[HP]	n°	[kg]

Single phase supply 200...240VAC 50/60Hz.
Three-phase motor output 240VAC max.
Built-in EMC suppressor, cat. C2.

VLA102A240	1.7	0.25	0.33	1	0.750
VLA104A240	2.4	0.4	0.5	1	0.750
VLA107A240	4.2	0.75	1	1	0.950
VLA115A240	7	1.5	2	1	1.350
VLA122A240	9.6	2.2	3	1	1.350

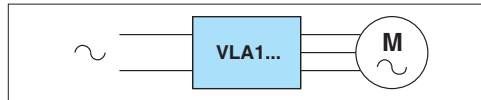

Accessories for VLA1



VLAXC01



VLAXC02



VLAXP01

Order code	Description	Qty per pkg	Weight
		n°	[kg]
VLAXC01	Display and keypad	1	0.050
VLAXC02	USB communication module	1	0.050
VLAXP01	Door-mount installation kit for the keypad VLAXC01. IP65, Type 4X. Connecting cable included, 3m long	1	0.340

General characteristics

VLA1... is an ultra-compact drive (book style housing) with high performance. It integrates different motor control modes, like V/f linear and quadratic and sensorless vector control. VLA1... is extremely versatile and can be used in several applications such as conveyor belts, machine tools, control of automatic doors, packaging machines and in particular to manage pumps and fans thanks to specific integrated functions like the PID control and flying restart. Simple to install and configure.

The user interface, which comprises of a built-in keypad and display, allows to access the setting parameters easily, thanks to the use of extended texts describing the functions and codes. Using the optional USB communication module, the programming, monitoring and diagnostic can be performed using a PC with software VLBXSW, freely downloadable from the website www.LovatoElectric.com, download section.

SPEED REFERENCE SIGNALS

Reference signals for speed adjustment are obtained by:

- External potentiometer 1...10kΩ
- Voltage signal 0...10VDC or current signal 0/4...20mA
- Buttons on front keypad
- Door-mount installation kit
- 15 preset speeds via digital inputs
- Motor potentiometer.

PROGRAMMABLE INPUTS AND OUTPUTS

- Selectable pNp or nPn logic
- 5 digital inputs
- 1 digital output
- 1 changeover relay output
- 2 analog inputs: 1 configurable as voltage input 0...10VDC or current input 0/4...20mA, 1 voltage input 0...10VDC
- 1 analog output configurable as voltage output 0...10VDC or current output 0/4...20mA.

PROTECTIONS

- Overcurrent
- Output short circuit and earth/ground leakage
- Overvoltage and undervoltage
- Phase loss
- Motor heat overload (I²t)
- Overspeed
- Speed reverse.

FUNCTIONS

- Speed or torque control
- V/f linear or quadratic curves
- Sensorless vector control
- Flying restart
- DC braking and DC injection at start
- Integrated PID with SLEEP and WAKE-UP thresholds
- Multi-pump PID control (1 main pump frequency regulated + 2 auxiliary pumps activated in on-off mode in case of necessity)
- Programmable frequency/time cycles
- Different parameter configurations
- User menu (favorite parameters)
- Programming and monitoring software VLBXSW, freely downloadable from the website www.LovatoElectric.com.

Operational characteristics

- Input voltage: 200...240VAC single-phase
- Rated operational current I_e: 1.7...9.6 A
- Mains frequency: 50/60Hz
- Output frequency: 0...599Hz
- Switching frequency: 2...16kHz
- Current overload: 150% for 60s; 200% for 3s
- IEC degree of protection: IP20
- Ambient conditions:
 - Operating temperature: -10...+55°C (45°C without derating)
 - Maximum altitude: 2000m (without derating)
 - Relative humidity: 5...95% (with no condensing)
- Side-by-side installation
- Built-in EMC suppressor (EN/BS 61800-3), cat. C2
- IE2 efficiency level (EN/BS 50598-2).

Certifications and compliance

Certifications: cULus, EAC, RCM.

Compliant with standards: EN/BS 61800-5-1, UL 61800-5-1, CSA 22.2 No. 274.

VT1... series (ultra-compact with RS485)



VT1...

new

Order code	Output current	3-phase motor power at 240V			Qty per pkg	Weight
	[A]	[kW]	[HP]	n°	[kg]	

Single-phase supply 200...240VAC 50/60Hz.
Three-phase motor output 240VAC max.
Built-in RS485 communication port.
Built-in EMC suppressor, cat. C2.

VT102A240	1.8	0.2	0.25	1	1.0
VT104A240	2.6	0.4	0.5	1	1.0
VT107A240	4.3	0.75	1	1	1.0
VT115A240	7.5	1.5	2	1	2.0
VT122A240	10.5	2.2	3	1	2.0

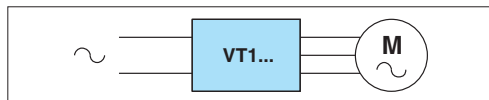

Accessories for VT1



VT1XC01



VT1XC02

new

Order code	Description	Qty per pkg	Weight
		n°	[kg]
VT1XC01	Cable RS485/USB for the connection VT1-PC ❶, 1.8m length	1	0,080
VT1XC02	Remote keypad (Ethernet connection cable ❷ not included), IP20, IP65 on front	1	0,122

❶ Software for programming and monitoring VT1XSW freely downloadable from the website www.LovatoElectric.com, download section.
❷ Use a standard Ethernet cable (CAT.5 or higher) max. 5m length.

General characteristics

VT1 is an ultra-compact variable speed drive with single phase input and built-in RS485 communication port. Simple and versatile, it can be used in several applications such as control of pumps and fans, conditioning systems, packaging machines, conveyor belts, control of automatic doors, etc. The extremely compact dimensions make it suitable for the installation in panels or machinery with limited space. The integrated RS485 communication port allows the remote control and monitoring of the drive from a supervision system or a controller such as a PLC or HMI. It supports the communication protocols Modbus-RTU, Modbus-ASCII and BACnet.

VT1 is extremely simple to install and configure. It can be programmed from the frontal keypad with digital display. Alternatively, it is possible to program the parameters from a PC with software VT1XSW and dedicated USB connection cable VT1XC01.

The different integrated motor control modes, like the linear or quadratic V/f control, multipoint curve and sensorless vector control, make it perfectly suitable for several type of loads and applications.

SPEED REFERENCE SIGNALS

Reference signals for speed adjustment are obtained by:

- Front jog dial control (potentiometer)
- External potentiometer 1...10kΩ
- Voltage signal 0...10V or current signal 0/4...20mA
- 8 preset speeds via digital inputs
- Optional remote keypad VT1XC02
- RS485 serial signals.

PROGRAMMABLE INPUTS AND OUTPUTS

- 5 multifunction digital inputs
- 1 voltage analog input 0...10VDC
- 1 current analog input 0/4...20mA
- 1 relay output with NO contact
- 1 voltage analog output 0...10VDC.

PROTECTIONS

- Motor and drive overload
- Overvoltage and undervoltage
- Phase loss
- Overtemperature
- Overspeed.

FUNCTIONS

- Speed control
- V/f linear or squared curves
- V/f customizable multipoint curve
- Sensorless (open loop) vector control
- Preset speeds
- Built-in PID with sleep and wake up thresholds
- Sequencer (programmable frequency/time cycles)
- DC braking and DC injection at start
- Multi-pump PID for the control of up to 4 VT1... drives in master-slave configuration
- Software for programming and monitoring VT1XSW, freely downloadable from the website www.LovatoElectric.com, download section.

Operational characteristics

- Input voltage: 200...240VAC single-phase
- Output voltage: 0...240VAC three-phase
- Rated operational current I_e: 1.8...10.5A
- Mains frequency: 50/60Hz
- Output frequency: 0...599Hz
- Switching frequency: 1...16kHz
- Current overload: 150% for 60s
- IEC degree of protection: IP20
- Ambient conditions:
 - Operating temperature:
 - -10...+40°C (50°C with derating of 40% of the output current) for sizes 0,2...0,75kW
 - -10...+50°C (without derating) for sizes 1,5 and 2,2kW with built-in fan
 - Maximum altitude: 1000m (without derating), 3000m (with derating of 2% of the rated current every 100m)
 - Relative humidity <95% (without condensation)
- Built-in EMC suppressor (EN/BS 61800-3), cat. C2.

Certifications and compliance

Certifications: cULus, EAC, RCM (excluded VT1XC01 and VT1XC02).
Compliant with standards: EN/BS 61800-5-1, UL 508C, CSA 22.2 No. 274.

VLB3 series



VLB3...



VLB3...XX



The drive efficiency is 25% higher than the reference value for the IE1 class.

- ① Complete drive: power unit + logic unit with Modbus-RTU + control unit with keypad and display.
- ② To be completed with logic unit VLBXL... and control unit VLBXC...
- ③ Operation up to 45°C without power derating.
- ④ Heavy load: 150% overload for 60s
- ⑤ Standard load: 120% overload for 60s
- ⑥ Functioning for standard load not available for this size. Refer to the ratings declared for heavy load.

Order code	Output current ^⑥	3-phase motor power at 400VAC with heavy load ^④		Qty per pkg.	Weight [kg]
	[A]	[kW]	[HP]	n°	

COMPLETE DRIVES^①
 Three-phase supply 400...480VAC 50/60Hz.
 Three-phase motor output max 480VAC.
 Built-in EMC suppressors.

VLB30004A480	1.3	0.4	0.5	1	0.850
VLB30007A480	2.4	0.75	1	1	1.100
VLB30015A480	3.9	1.5	2	1	1.380
VLB30022A480	5.6	2.2	3	1	1.380
VLB30040A480	9.5	4	5	1	2.450
VLB30055A480	13	5.5	7.5	1	2.450
VLB30075A480	16.5	7.5	10	1	3.950
VLB30110A480	23.5	11	15	1	3.950
VLB30150A480	32	15	20	1	10.650
VLB30185A480	40	18.5	25	1	10.650
VLB30220A480	47	22	30	1	10.650
VLB30300A480	61	30	40	1	17.500

POWER UNITS^②
 Three-phase supply 400...480VAC 50/60Hz.
 Three-phase motor output max 480VAC.
 Built-in EMC suppressors.

VLB30004A480XX	1.3	0.4	0.5	1	0.800
VLB30007A480XX	2.4	0.75	1	1	1.000
VLB30015A480XX	3.9	1.5	2	1	1.350
VLB30022A480XX	5.6	2.2	3	1	1.350
VLB30040A480XX	9.5	4	5	1	2.300
VLB30055A480XX	13	5.5	7.5	1	2.300
VLB30075A480XX	16.5	7.5	10	1	3.700
VLB30110A480XX	23.5	11	15	1	3.700
VLB30150A480XX	32	15	20	1	10.300
VLB30185A480XX	40	18.5	25	1	10.300
VLB30220A480XX	47	22	30	1	10.300
VLB30300A480XX	61	30	40	1	17.200
VLB30370A480XX	76	37	50	1	17.200
VLB30450A480XX	89	45	60	1	17.200
VLB30550A480XX	110	55	75	1	24.000
VLB30750A480XX	150	75	100	1	24.000
VLB30900A480XX	180	90	120	1	35.600
VLB31100A480XX	212	110	150	1	35.600

Operational characteristics for standard load^⑤

Order code	le ^③	3-phase motor power at 400VAC with standard load		
		[A]	[kW]	[HP]
Complete drives ^①	Power units ^②	[A]	[kW]	[HP]
VLB30004A480	VLB30004A480XX	⑥	⑥	⑥
VLB30007A480	VLB30007A480XX	⑥	⑥	⑥
VLB30015A480	VLB30015A480XX	⑥	⑥	⑥
VLB30022A480	VLB30022A480XX	⑥	⑥	⑥
VLB30040A480	VLB30040A480XX	11.9	5.5	7.5
VLB30055A480	VLB30055A480XX	15.6	7.5	10
VLB30075A480	VLB30075A480XX	23	11	15
VLB30110A480	VLB30110A480XX	28.2	15	20
VLB30150A480	VLB30150A480XX	38.4	18.5	25
VLB30185A480	VLB30185A480XX	48	22	30
VLB30220A480	VLB30220A480XX	56.4	30	40
VLB30300A480	VLB30300A480XX	73.2	37	50
-	VLB30370A480XX	91.2	45	60
-	VLB30450A480XX	107	55	75
-	VLB30550A480XX	132	75	100
-	VLB30750A480XX	180	90	120
-	VLB30900A480XX	216	110	150
-	VLB31100A480XX	254	132	175

General characteristics

VLB3... is a compact drive (book style housing) with three-phase supply input. It is ideal for general applications and, in particular, to control and manage pumps and fans, thanks to several specific built-in functions (S Curve, PID, torque quadratic V/f control). It does not require any space for side ventilation, allowing several drives to be installed side-by-side. The user interface, which comprises of a built-in keyboard and display, allows easy access to the setting of parameters, thanks to the use of extended texts describing the functions and codes. Using the USB or Wi-Fi connection accessories, the programming, monitoring and diagnostics can be performed using a PC with software VLBXSW, freely downloadable from the website www.LovatoElectric.com. The RS485 communication port with built-in Modbus-RTU (integrated in the complete drives VLB3... A480) and EMC filter complete the hardware supply. The logic unit can be replaced with one of the VLBXL... codes, obtaining a communication port with different protocol.

SPEED REFERENCE SIGNALS

- External potentiometer: 1...10kΩ
- Voltage signals -10...+10VDC (two-pole), 0...10VDC or current signals 0/4...20mA
- Buttons on front keyboard
- Remote control panel
- 15 preset speeds via digital inputs
- Motor potentiometer
- Setting via communication protocol.

PROGRAMMABLE INPUTS AND OUTPUTS

- Selectable pNp or nPn logic
- 5 digital inputs
- 1 digital output, 1 changeover relay output
- 2 analog inputs configurable as voltage inputs (0/2...10VDC, -10...+10VDC, 0...5VDC) or current inputs 0/4...20mA
- 1 analog output configurable as voltage output 0...10VDC or current output 0/4...20mA.

PROTECTIONS

- Overcurrent
- Output short circuit and earth/ground leakage
- Overvoltage and undervoltage
- Phase loss
- Motor heat overload (I²t)
- Motor PTC heat protection
- Drive, motor and braking resistor overload
- Overspeed
- Speed reverse.

FUNCTIONS

- Speed or torque control
- V/f linear or quadratic curves
- Open or closed loop vector control
- Energy-saving ECO control
- S curves
- Flying restart
- Access to DC bus
- DC braking and DC injection at start
- Built-in PID with SLEEP and WAKE-UP thresholds
- Multi-pump PID control (1 main pump frequency regulated + 2 auxiliary pumps activated in on-off mode in case of necessity)
- Programmable frequency/time cycles
- Ideal for asynchronous or synchronous motors (up to 22kW)
- Different parameter configurations
- User menu (favorite parameters)
- Safe Torque Off (STO) input accessory class SIL 3 (EN/BS 62061 / EN/BS 61800-5-2)
- Programming and monitoring software VLBXSW freely, downloadable from the website www.LovatoElectric.com.

Operational characteristics

- Input voltage: 400...480VAC three-phase
- Rated operational current: 1.3...212A
- Mains frequency: 45...65Hz
- Output frequency: 0...599Hz
- Switching frequency: 2...16kHz
- Current overload: 150% for 60s; 200% for 3s
- IEC degree of protection: IP20
- Ambient conditions
 - Operating temperature: -10...+55°C (45°C without derating)
 - Maximum altitude: 4000m (with power derating)
 - Relative humidity: 5...95% (with no condensing)
- Side-by-side installation
- Built-in EMC suppressor (EN/BS 61800-3) motor cable length: up to 3m for cat. C1 (for sizes 0.4 and 0.75kW); up to 20m for cat. C2
- IE2 efficiency level (EN/BS 50598-2).

Certifications and compliance

Certifications obtained: cULus, EAC, RCM.
 Compliant with standards: EN/BS 61800-5-1, UL 61800-5-1, CSA 22.2 No. 274.

Accessories for VLB3



VLBXC00



VLBXC01



VLBXC02



VLBXC03



VLBXSM



VLBXL...



EXCRDU1



VLBXP01

Order code	Description	Qty per pkg.	Wt [kg]
VLBXC00	Blanking cover	4	0.128
VLBXC01	Keypad and display	1	0.080
VLBXC02	USB communication module	1	0.080
VLBXC03	Wi-Fi communication module	1	0.080
VLBXSM	Safe Torque Off (STO) module	1	0.080
VLBXL01	Logic unit with CANopen	1	0.209
VLBXL02	Logic unit with Profibus	1	0.209
VLBXL03	Logic unit with ProfiNET	1	0.209
VLBXL04	Logic unit with Ethercat	1	0.209
VLBXL06	Logic unit with Modbus-RTU	1	0.209
VLBXP01	Door-mount installation kit for the keypad VLBXC01, IP65, Type 4X, connecting cable included 3m long	1	0.340
EXCRDU1	Remote display unit, LCD graphic touch screen, RS485 port integrated, for monitoring and control of up to 32 drives, IP65 and 4X, cable included 3m long	1	0.360

General characteristics

CONTROL UNITS VLBXC...

The variable speed drives VLB3... series can be programmed with the control unit VLBXC01 (keypad and display) or alternatively from a PC with the software VLBXSW (freely downloadable from the website www.LovatoElectric.com) by using the communication modules VLBXC02 (USB) and VLBXC03 (Wi-Fi).

SAFE TORQUE OFF (STO) MODULE VLBXSM

The VLBXSM module allows to increase and optimize the safety functions of the drive providing two inputs dedicated to the function Safe Torque Off (STO) with performance level ISO 13849-1 (EN/BS 954-1), safety class SIL 3 (EN/BS 62061 / EN/BS 61800-5-2).

LOGIC UNITS VLBXL...

Thanks to their modular structure, on the VLB3... series variable speed drives it is possible to replace the logic unit with Modbus-RTU protocol (integrated as standard on the complete drives VLB3...A480) with one of the logic units VLBXL..., available in the versions with the most common fieldbus, obtaining a drive with a different communication port, which allows its integration inside control systems.

DOOR-MOUNT INSTALLATION KIT VLBXP01

With the kit VLBXP01 it is possible to mount the keypad and display VLBXC01 (provided as standard on the complete drives VLB3...A480 or purchased as an optional accessory for the power units VLB3...A480XX) on the panel door. The door-mounting kit has an IP65 and Type 4X degree of protection and it is provided with an Ethernet connection cable 3 meters long.

REMOTE DISPLAY UNIT EXCRDU1

The remote display unit EXCRDU1 allows the command and monitoring of up to 32 variable speed drives VLB3... series, connected in RS485 (Modbus-RTU protocol).

It provides the following functions:

- Command of the start and stop of the motor
- Adjustment of the speed of the motor
- Inversion of the sense of rotation of the motor
- Monitoring of the main electrical measures of the system
- Control of the status of the drive and presence of alarms
- PID control and monitoring of the status.

Technical characteristics:

- Auxiliary supply 100...240VAC / 110...250VDC
- Graphic LCD display with touch screen, 128x112 pixel
- Opto-isolated RS485 port, Modbus-RTU protocol
- Flush mount housing, compatible with DIN 96x96mm and ANSI 4"
- Compatible with VLB3 drives equipped with Modbus-RTU logic unit
- Cable for RS485 connection included, 3 meters long
- Degree of protection on front IP65 and 4X.

Certifications and compliance

Certifications obtained: cULus, EAC and RCM (only for VLBXC..., VLBXSM and VLBXL...).

Compliant with standards: EN/BS 61800-5-1, UL 61800-5-1, CSA 22.2 No. 274.

Three-phase mains chokes



VLBXL...

Order code	I _e	Inductance	Power	Qty per pkg.	Weight
	[A]	[mH]	[kW]	n°	[kg]
Three phase mains chokes for VLB3... variable speed drives.					
VLBXL590	50	0.59	22...30	1	8.350
VLBXL370	80	0.37	37	1	12.500
VLBXL330	90	0.33	45	1	16.000
VLBXL300	100	0.30	55	1	19.000
VLBXL190	160	0.19	75	1	26.000
VLBXL140	200	0.14	90...110	1	32.000

General characteristics

VLBXL... three-phase mains chokes are applied to the input of VLB3... drives from 22kW to 110kW to reduce the harmonic content upstream, with consequent reduction of the input current absorbed by the drives.

For the correct choice, select the inductance with current rating equal to or greater than the rated current of the drive they will be used with.

Operational characteristics

- Current: 50...200A.
- Operating temperature: -10...+55°C (40°C without derating)

Compliance

Compliant with standards: IEC/EN/BS 61558-1.

Three-phase motor chokes



VLXM...

new

Order code	I _e	Inductance	Power	Qty per pkg.	Weight
	[A]	[mH]	[kW]	n°	[kg]
Three phase motor chokes for VLA1... - VT1... - VLB3... variable speed drives.					
VLXM012	12.5	1	0.2...4	1	3.000
VLXM025	25	0.6	5.5...11	1	6.000
VLXM050	50	0.2	15...22	1	8.000
VLXM100	100	0.15	30...45	1	16.000
VLXM150	150	0.08	55...75	1	18.000
VLXM300	300	0.04	90...110	1	29.000

General characteristics

Three phase motor chokes VLXM... can be installed to the drive output, to reduce the voltage peaks generated by the drive towards the motor, or when several parallel motors are simultaneously controlled by the drives.

For the correct choice, select the inductance with I_e current rating equal to or greater than the rated current of the drive they will be used with.

Operational characteristics

- Rated grid voltage: 400VAC
- Operating range: 170...530VAC
- Rated frequency: 50/60Hz
- Winding material: Aluminium
- Rated current I_e: 12.5...300A type code according
- Rated power: 150...3390VA type code according
- Saturation current: 1.5*I_e
- THD: about 40%
- Ambient temperature max: 40°C
- Maximum altitude: 1000m
- Insulation class: F
- Working class: F
- Test voltage: 3kV/1 sec
- Protection degree: IP00.

Compliance

Compliant with standards: IEC/EN/BS 61558.

Braking resistors



VLBXR...

Order code	Output	Resistance	Power	Qty per pkg.	Wt
	[W]	[Ω]	[kW]	n°	[kg]
Resistors for VLB3... variable speed drives.					
VLBXR390	100	390	0.4...0.75	1	0.260
VLBXR180	200	180	1.5...2.2	1	0.630
VLBXR047	200	47	4...5.5	1	0.500
VLBXR027	200	27	7.5...11	1	0.500
VLBXR018	800	18	15	1	4.200
VLBXR015	800	15	18.5...22	1	4.200
VLBXR007	1900	7.5	30...75	1	9.500

General characteristics

Braking resistors can be connected to VLB3 drives in order to absorb the power generated during the motor stop phase.

Certifications and compliance

Certifications obtained: EAC.
Compliant with standards: IEC/EN/BS 60204-1, IEC/EN/BS 60664-1.

Other accessories



LPCPA001

Order code	Description	Qty per pkg.	Wt
		n°	[kg]
Potentiometer.			
LPCPA001	1k Ohm potentiometer 1 turn, complete with operating knob IP66, IP67 and IP69K on front	10	0.040

For more information consult page 7-34.

6 Variable speed drives

Dimensions [mm (in)]

SINGLE-PHASE VARIABLE SPEED DRIVES

VLA102A240 - VLA104A240

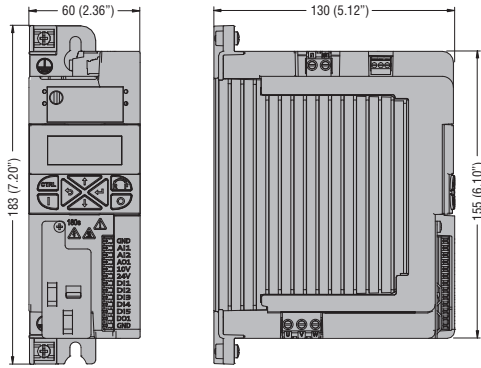

VLA107A240

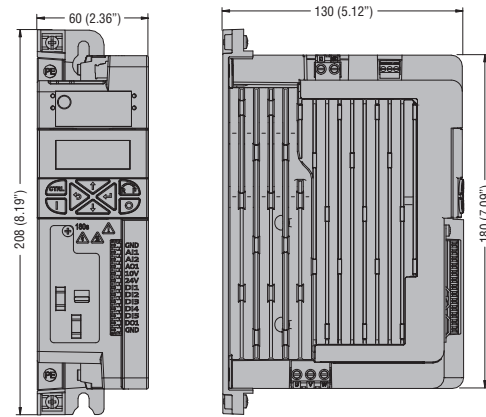

VLA115A240 - VLA122A240

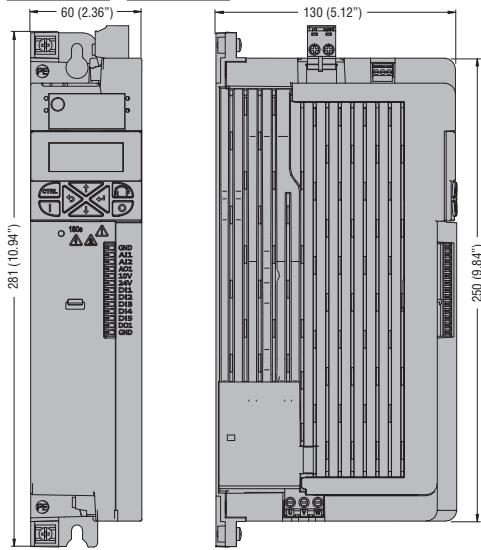

VT102A240 - VT104A240 - VT107A240

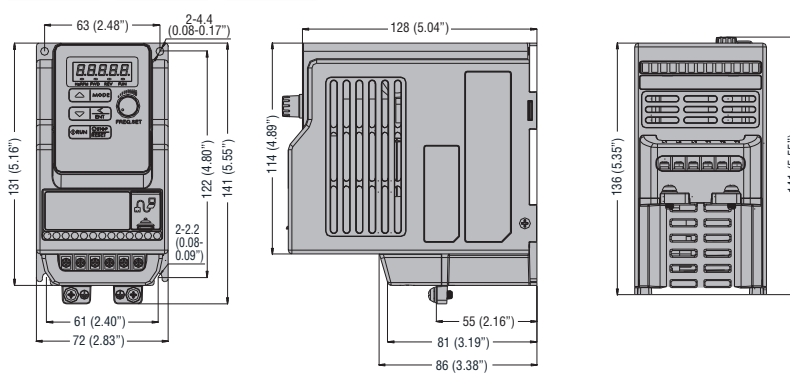

VT115A240 - VT122A240

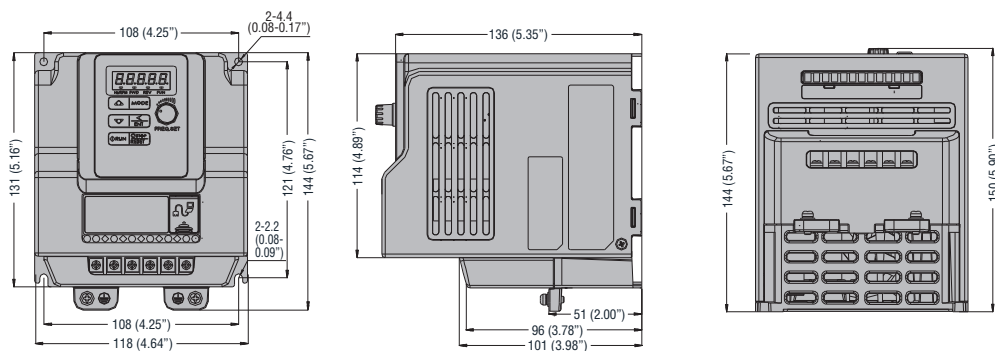

6 Variable speed drives

Dimensions [mm (in)]

THREE-PHASE VARIABLE SPEED DRIVES

VLB30004A480

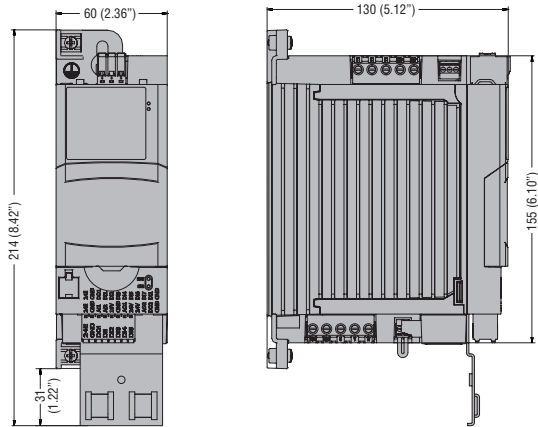

VLB30007A480

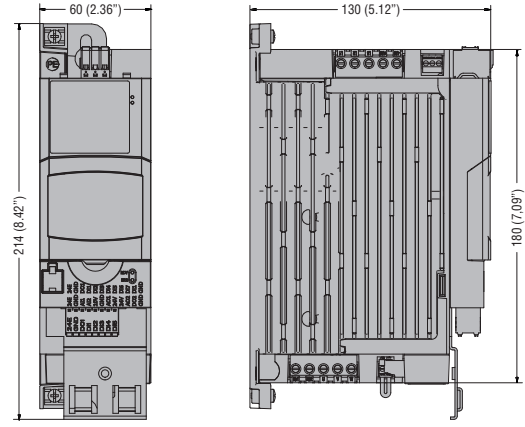

VLB30015A480 - VLB30022A480 - VLB30040A480

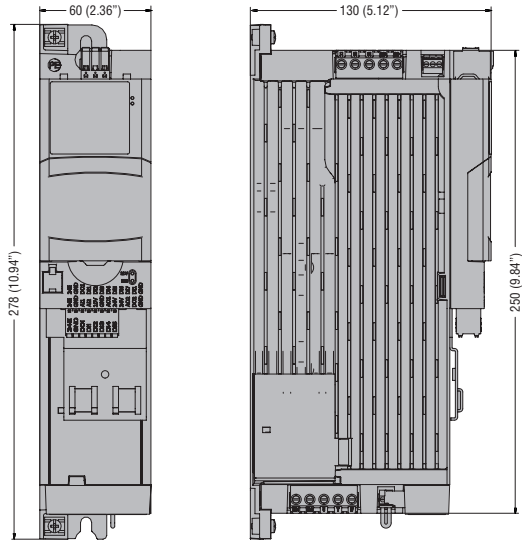

VLB30055A480

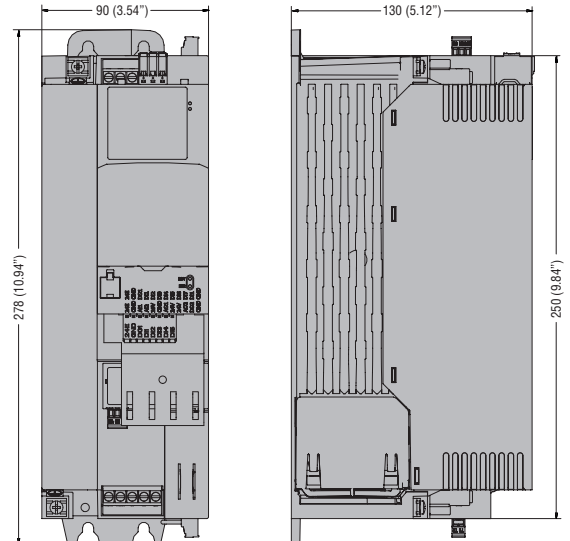

VLB30075A480 - VLB30110A480

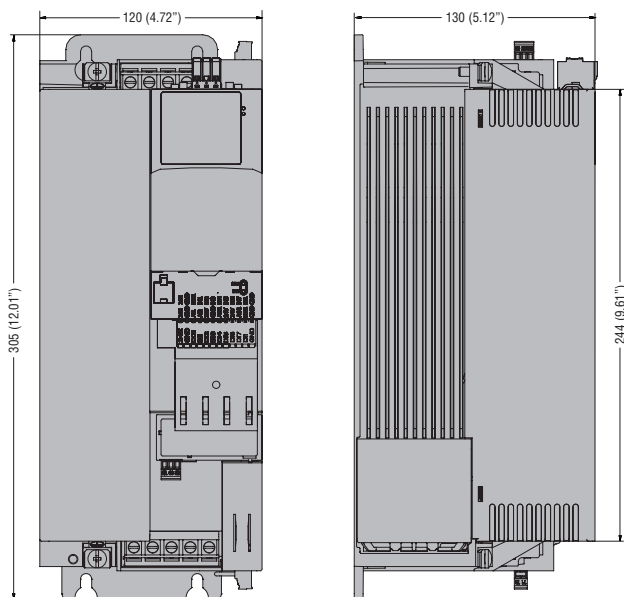

6 Variable speed drives

Dimensions [mm (in)]

VLB30150A480...VLB31100A480

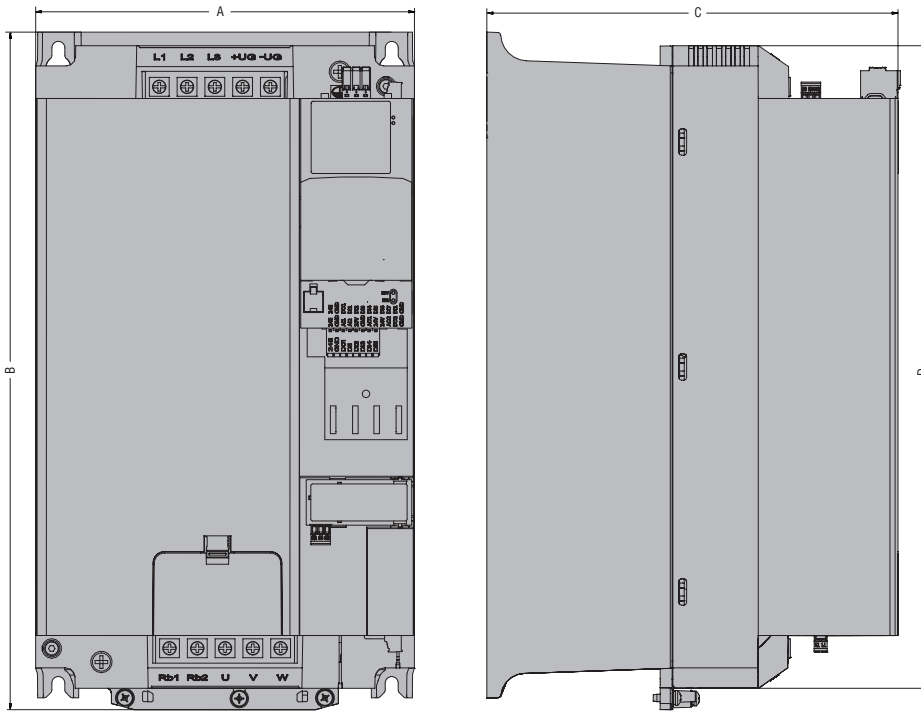

TYPE	A	B	C	D
VLB30150A480	204.5 (8.05")	366 (14.41")	222 (8.74")	347 (13.66")
VLB30185A480	204.5 (8.05")	366 (14.41")	222 (8.74")	347 (13.66")
VLB30220A480	204.5 (8.05")	366 (14.41")	222 (8.74")	347 (13.66")
VLB30300A480	250 (9.84")	520 (20.47")	230 (9.05")	450 (17.72")
VLB30370A480	250 (9.84")	520 (20.47")	230 (9.05")	450 (17.72")
VLB30450A480	250 (9.84")	520 (20.47")	230 (9.05")	450 (17.72")
VLB30550A480	250 (9.84")	623 (24.53")	265 (10.43")	536 (21.10")
VLB30750A480	250 (9.84")	623 (24.53")	265 (10.43")	536 (21.10")
VLB30900A480	258 (10.16")	775 (30.51")	304 (11.97")	685 (26.97")
VLB31100A480	258 (10.16")	775 (30.51")	304 (11.97")	685 (26.97")

Remote keypads
VLAXP01 - VLBP01

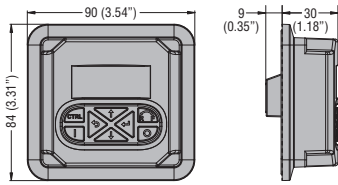

Cutout

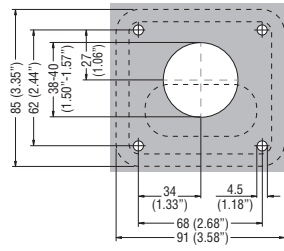

VT1XC02

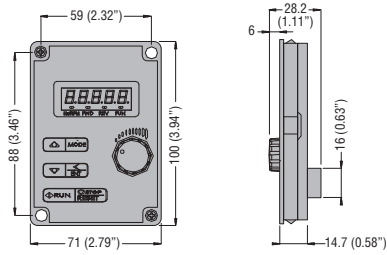

Cutout

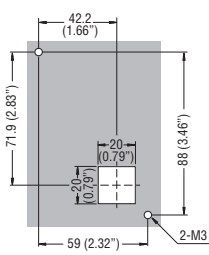

EXCRDU1

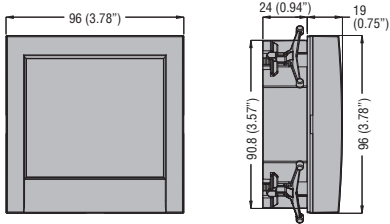

Cutout

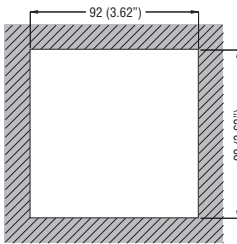

NOTE: for inductances, motor chokes and resistors refer to www.LovatoElectric.com.

- Different types of actuators: metal, flat metal and chrome finished plastic
- Simple and snap on installation
- Highly conductive contacts
- Robust for severe ambient conditions
- Contact operation: double breaking action, direct opening operation and self cleaning
- Plastic and metal enclosure.

PLatinum series

	SERIES SEC.	LPS - PAGE	LPF PAGE	LPC PAGE
Pushbutton actuators, spring return and push-push	7 -	6	16	24
Mechanical reset button, spring return	7 -	7	-	25
Pushbutton actuators with symbol, spring return	7 -	7	17	25
Mushroom-head pushbutton actuators	7 -	8	-	26
Double and triple-touch button actuators, spring return	7 -	9	-	27
Selector switch actuators, lever and key	7 -	10	18	28
Selector switch actuator knobs	7 -	11	19	29
Illuminated pushbutton actuators, spring return and push-push	7 -	12	20	30
Illuminated mushroom-head pushbutton actuators	7 -	12	-	30
Double-touch button actuators, spring return with indicator	7 -	13	-	31
Illuminated selector actuators.....	7 -	13	21	31
Pilot light heads	7 -	14	22	32
USB and RJ45 communication interfaces	7 -	-	23	32
Joysticks	7 -	15	-	-
Monoblock LED pilot lights, steady light	7 -	-	-	33
Monoblock potentiometers	7 -	-	-	34
Monoblock buzzers	7 -	-	-	34
Pushbutton actuators, spring return with symbol	7 -	35		
Mounting adapters	7 -	36		
Contact elements	7 -	37		
LED and test elements	7 -	39		
Accessories, spare parts and labels	7 -	44		
Plastic control stations	7 -	52		
Palm switches	7 -	59		
Metal control stations and enclosures	7 -	60		
Dimensions	7 -	62		
Wiring diagrams	7 -	69		

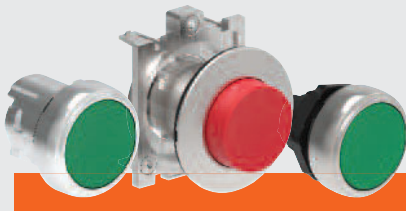

BUTTON ACTUATORS

- Spring return flush, extended and shrouded
- Push-push flush and extended
- Mushroom-head
- Mechanical reset
- Illuminated.



DOUBLE AND TRIPLE-TOUCH ACTUATORS

- Double-touch with or without indicator
- Triple-touch.

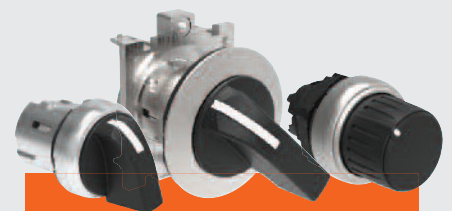

SELECTOR SWITCHES

- Short lever
- Long lever
- Key
- Knob
- Illuminated.



PILOT LIGHTS Ø22mm

- Monoblock LED.

MONOBLOCK BUZZERS Ø22mm

- Continuous or pulse tone.

COMMUNICATION INTERFACES

- USB.
- RJ45.



POTENTIOMETERS Ø22mm

- Potentiometer included in the product with graduated scale
- Potentiometer drives with:
 - graduated scale
 - variable index.

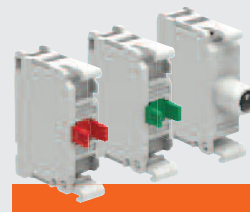

ADD-ON ELEMENTS, ACCESSORIES AND SPARE PARTS

- Mounting adapters
- Contact elements
- Lamp holders
- LED integrated elements
- Labels, label holders, protections, etc.



JOYSTICKS Ø22mm

- 2 directions
- 4 directions
- 2 directions with mechanical interlock
- 4 directions with mechanical interlock
- Complete with contact elements.

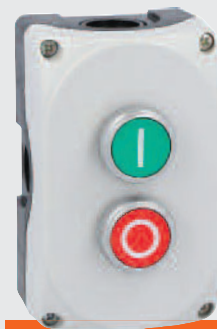

PLASTIC CONTROL STATIONS

- 1 to 6 holes option without actuators
- Complete versions from 1 to 3 actuators in various combinations.



METAL CONTROL STATIONS

- Without actuators (from 1 to 16 holes)
- Version without holes.

A COMPLETE SERIES AT YOUR FINGERTIPS!



PLatinum

- **HIGH DEGREE OF PROTECTION IP66, IP67 and IP69K**

The actuators have been tested to guarantee a degree of protection per IEC/EN IP66, IP67, IP69K and per UL Type 4X, appropriate for use even in extreme ambient conditions.

- **ELEGANT STYLE AND ERGONOMIC DESIGN**

All the series elements have an ergonomic design and, at the same time, particular care has been given to the finest detail aesthetics.

- **LONG ACTUATOR MECHANICAL LIFE**

High performance characteristics assure 5,000,000 cycle mechanical life for spring return actuators, 1,000,000 for double and triple touch units and 300,000 for emergency-stop types.

- **MATERIALS RESISTANT TO OILS, SOLVENTS AND HYDROCARBONS**

- **CUSTOMIZATION**

To facilitate warehouse management, it is possible to purchase spring return or push-push button actuators without caps or lenses and at the same time caps and lenses as spare parts. This allows for custom buttons to be completed from stock.



- **HIGH STANDARDIZATION**

Contact elements, LED light elements and a wide range of accessories are common to all types of the series.

- **USAGE AT EXTREME TEMPERATURE CONDITIONS**

Operation temperature range between -25° and $+70^{\circ}\text{C}$.

- **CERTIFICATIONS: cULus, EAC, RINA and CCC.**

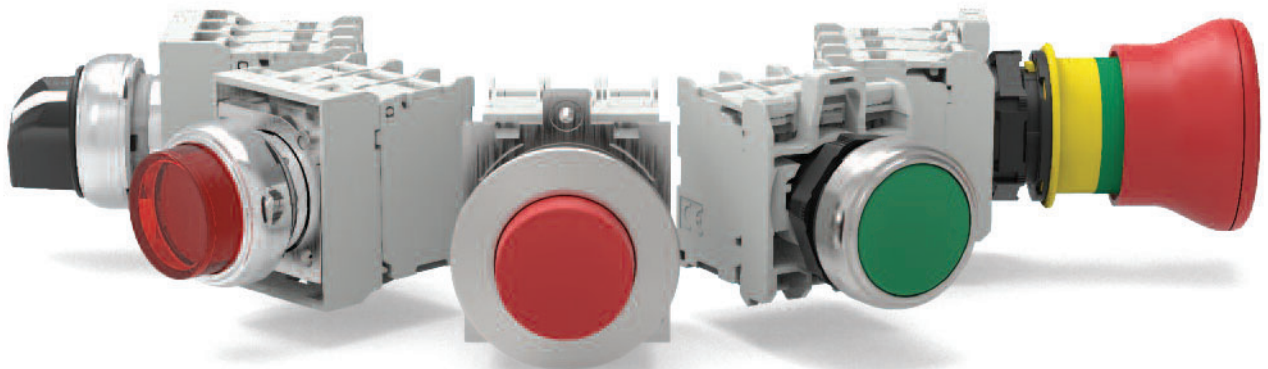

Ø30MM FLAT METAL **LPF**

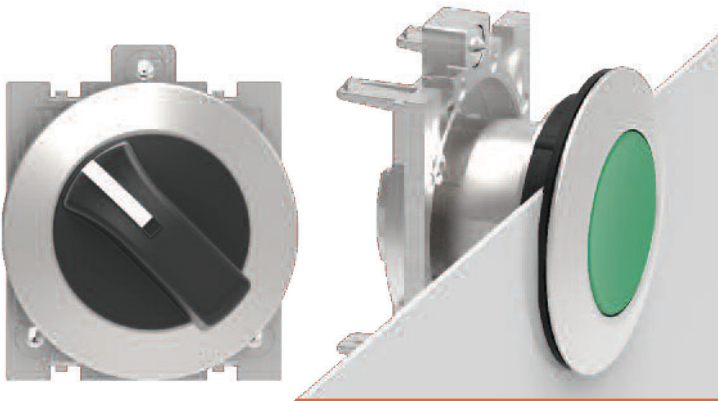

- OPERATORS MADE OF ALUMINIUM AND ZINC ALLOY
- ACTUATOR PROFILE OF ONLY 4mm
- HIGH STRENGTH
- ERGONOMIC AND FUNCTIONAL
- SCREW PANEL FIXING
- TYPES
 - spring return and push-push button actuators
 - lever, key and knob selectors
 - illuminated spring return and push-push button actuators
 - illuminated lever selectors
 - USB and RJ45 communication interfaces.

Ø22MM METAL **LPS**



- OPERATORS MADE OF ALUMINIUM AND ZINC ALLOY
- HIGH STRENGTH AND IMPACT RESISTANCE
- SCREW PANEL FIXING
- TYPES
 - spring return and push-push button actuators
 - spring return mechanical reset button actuators
 - mushroom head push button actuators
 - spring return double and triple-touch button actuators
 - lever, key and knob selector switch actuators
 - illuminated spring return, push-push and mushroom-head actuators
 - spring return double-touch button actuators with indicator
 - illuminated lever selectors
 - joysticks.

Ø22MM CHROMED PLASTIC **LPC**



- ACTUATORS MADE OF POLYAMIDE WITH EXTERNAL CHROME RING
- SNAP-ON FAST INSTALLATION OF THE MOUNTING BASE AND CONTACT ELEMENTS
- PANEL FIXING BY THREADED RING
- TYPES
 - spring return and push-push button actuators
 - spring return mechanical reset button actuators
 - mushroom head push button actuators
 - spring return double and triple-touch button actuators
 - lever, key and knob selector switch actuators
 - illuminated spring return, push-push and mushroom-head actuators
 - spring return double-touch button actuators with indicator
 - illuminated lever selectors
 - monoblock LED pilot lights
 - monoblock potentiometers and buzzers
 - USB and RJ45 communication interfaces.

QUICK AND EASY ACTUATOR INSTALLATION

Ø30mm FLAT METAL

- The operator fits into the Ø30mm panel hole with an adapter that retains it securely by two screws.

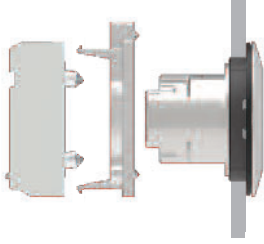

- The operator has a seal with rubber grommets which ensure stable fitting.

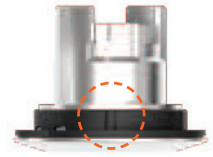

Ø22mm METAL

- The operator fits into the Ø22mm panel hole with an adapter that retains it securely by two screws.

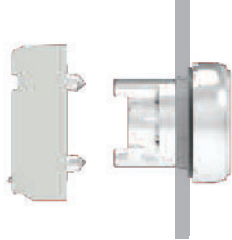

- The operator has a seal with rubber grommets to ensure stable fitting.

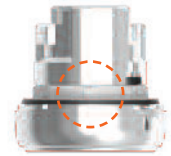

Ø22mm CHROMED PLASTIC

- The operator mounts to the Ø22mm panel hole with a threaded ring. The mounting base snaps onto the back of the operator itself.

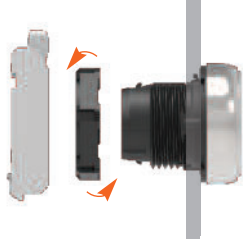

- The operator has a seal with rubber grommets to ensure stable fitting.
- The anti-rotation lug on the operator collapses into the seal to enable installation even to round holes without an anti-rotation notch.
- The mounting plate and operators have clearly visible reference marks to facilitate snapping the operators onto the base.

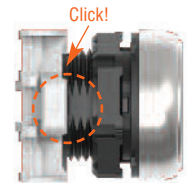

CONTACT ELEMENTS

- Common to all Platinum series operators.
- Miniaturised size
- High electric conductivity - 5V 1mA
- Up to 9 contact elements can be installed
- Versions with screw, spring-clamp (push-in), Faston and base mount contact blocks for use with LPZP control stations
- Contact operation: double breaking action, direct (positive) action operation and wiping effect.
- Electrical contact and LED elements are snapped onto the mounting adapter.
- The activation of the middle contact is standard supplied on all non-illuminated spring return and push-push button or selector switch actuators.

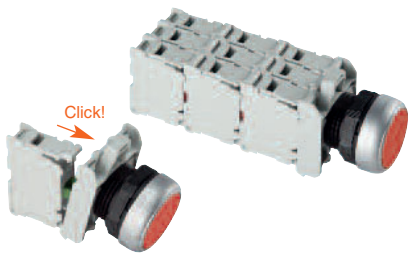

CONTACT AND LED ELEMENTS WITH SPRING-CLAMP (PUSH-IN) TECHNOLOGY

- PUSH-IN technology reduces the time required to connect stiff cables and cables with crimped terminals. The wire simply inserts into the clamp for a secure, sealed connection - no screwdriver needed!
- The clamping force is long-lasting and unaffected by vibration and impact.

Push-in technology



HIGH-LUMINOSITY LED ELEMENTS

- Miniaturised size
- Long electrical life: 100,000h
- Versions with screw, spring-clamp (push-in) and for bottom of LPZP control stations
- Overvoltage protection
- Withstand vibrations
- Protection against stray currents in wiring
- Flickering phenomenon reduction
- Steady and flashing light versions
- Supply voltages: 12...30VAC/DC, 85...140VAC, 185...265VAC
- Test elements installed alongside and connected with the relative LED element allow checking if all LED elements of the installation are working properly.



LOW PROFILE OPERATORS AND COMPACT FOOTPRINT

- The operator's external collar has a low profile and reduced front depth.
- The total depth from the panel surface to the first contact element is just 43mm for the Ø22mm metal/plastic type, and 49mm for the Ø30mm flush-mounting metal type.

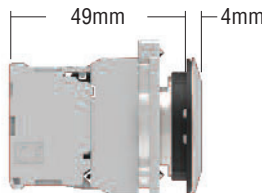

Ø30mm flat metal

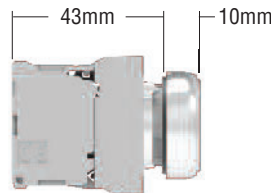

Ø22mm metal

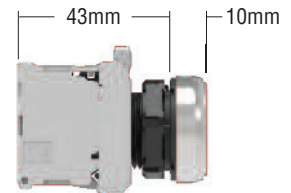

Ø22mm chromed plastic

DOUBLE AND TRIPLE-TOUCH ACTUATORS



- IEC IP66, IP67, IP69K and UL Type 4X degree of protection
- Double-touch button actuators, with 2 flush or 1 flush and 1 extended buttons
- Triple-touch button actuators with 2 flush and middle extended buttons
- Versions with or without indicator.

MECHANICAL RESET BUTTONS

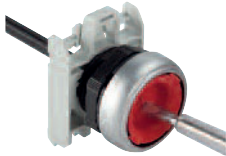

- Rod adjustment directly on actuator front (1...4mm/0.04...0.16")



- Up to 6 contact elements can be mounted.

EMERGENCY STOP ACTUATORS



- Actuator structure suitable to warrant direct opening operation with mechanical latching for emergency stopping per ISO 13850 and IEC/EN/BS 60947-5-5
- There is a green line around the actuator body to spot when the emergency stop is at rest or activated
- Use of **Ronis key**
- Various accessories available (e.g. yellow E-stop disks, padlockable protection, rubber actuator boots, label holders and labels)
- Auto-monitor contact elements are available with functions to:
 - Constantly control the correct installation (mounting adapter and NC contact with the actuator) and proper operation of the NC contact
 - Open the circuit in the case of malfunctions (e.g. the contact detaches from the mounting adapter due to strong vibrations or shock).



SELECTOR SWITCH ACTUATORS



- Lever design assures excellent grip
- Option to differentiate the actuation of the central contact



- **High visibility** on front or side and actuator inscription shows exact switch position



- Use of **Ronis key**



- **Activation of the middle contacts is standard supplied** on 2 and 3 position selector switches.

PILOT LIGHTS



- Protection rating IP66, IP67, IP69K and UL Type 4X for LED monoblock pilot lights and pilot light heads
- Long life and low consumption
- Supply voltages:
 - 110...120VAC, 230VAC, 380...415VAC
 - 110...125VDC, 220VDC
 - 12VAC/DC, 24VAC/DC, 48VAC/DC.

MONOBLOCK POTENTIOMETERS

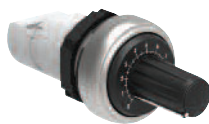

- Potentiometer included in the product
- Protection rating IP66, IP67 and IP69K and UL Type 4X
- Resistance values from 1 to 500kΩ.

ADAPTER FOR Ø30MM HOLES



- Allows installation of Ø22mm operators in Ø30mm holes
- Two versions; one for buttons and selector switches and one for emergency buttons.

MONOBLOCK BUZZERS



- Continuous or pulse-tone monoblock buzzers in a single product
- IP40 version (90dB/10cm) and IP66, IP67, IP69K and UL Type 4X, version (80dB/10cm) available.

COMMUNICATION INTERFACES



- Protection rating IP65, UL Type 4X
- USB and RJ45 for Ethernet types with data transmission in both directions
- USB type 3.0 (backward compatible with USB 2.0)
- Versions complete with cable.

JOYSTICKS



- Complete with contact elements
- **2 and 4 directions** available versions with or without mechanical interlock.

ACCESSORIES

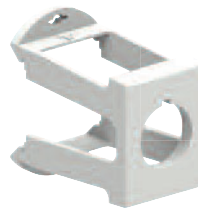

- DIN rail adapter
- Label holders and labels
- Rubber operator hoods
- Padlockable protection
- Protective covers.

PLASTIC CONTROL STATIONS



- Protection rating IP66, IP67, IP69K and Type 4X per UL
- 1 to 6 hole empty versions
- Complete 1 to 3 operator versions in a variety of combinations
- Quick installation and easy cabling of the contacts and LED elements with mounting to the bottom (snap mounting to the base)
- Option to also install screw-in and spring-mounting LED elements together with the operator inside the cover panel.

MOUNTING THE CONTACTS TO THE BOTTOM OF THE CONTROL STATION



- The use of contact and LED lamp holder elements that snap mount to the bottom of the control station makes for easier cabling.

YELLOW CONTROL STATION WITH ACTUATOR SHROUD



- Protective cover integrated into the button panel cover
- Protection rating IP66, IP67, IP69K and UL Type 4X
- 4 knockout holes for cable wiring
- Kit of 4 caps to protect the screws.

METAL CONTROL STATIONS



- Protection rating IP66, IP67 and UL Type 4X
- From 1 to 16 holes version
- 1 hole version with actuator protection
- Version without holes.

Pushbutton actuators, spring return



LPSB10...



LPSB20...



LPSB30...

new

Order code	Colour	Qty per pkg n°	Wt [kg]
Flush (without mounting adapter). Spring return.			
LPSB102	Black	5	0.031
LPSB103	Green	5	0.031
LPSB104	Red	5	0.031
LPSB105	Yellow	5	0.031
LPSB106	Blue	5	0.031
LPSB108	White	5	0.031
Extended (without mounting adapter). Spring return.			
LPSB202	Black	5	0.033
LPSB203	Green	5	0.033
LPSB204	Red	5	0.033
LPSB205	Yellow	1	0.033
LPSB206	Blue	1	0.033
LPSB208	White	1	0.033
Shrouded (without mounting adapter). Spring return.			
LPSB302	Black	5	0.033
LPSB303	Green	5	0.033
LPSB304	Red	5	0.033
LPSB305	Yellow	1	0.033
LPSB306	Blue	1	0.033
LPSB308	White	1	0.033

Push-push button actuators



LPSQ10...



LPSQ20...

new

Order code	Colour	Qty per pkg n°	Wt [kg]
Flush (without mounting adapter). Push on-push off.			
LPSQ102Ⓢ	Black	5	0.031
LPSQ103Ⓢ	Green	5	0.031
LPSQ104Ⓢ	Red	5	0.031
LPSQ105Ⓢ	Yellow	1	0.031
LPSQ106Ⓢ	Blue	1	0.031
LPSQ108Ⓢ	White	1	0.031
Extended (without mounting adapter). Push on-push off.			
LPSQ202Ⓢ	Black	5	0.033
LPSQ203Ⓢ	Green	5	0.033
LPSQ204Ⓢ	Red	5	0.033
LPSQ205Ⓢ	Yellow	1	0.033
LPSQ206Ⓢ	Blue	1	0.033
LPSQ208Ⓢ	White	1	0.033

Ⓢ Use contact elements LPXC10A (EM) and LPXC01 (NC) only.
Contact elements LPXC10 (NO) and LPXC01D (LB) cannot be fitted on these actuators.
For the number of contacts that can be fitted, see the indication here to the side.

Operational characteristics

- Any mounting position allowed
- Ambient conditions:
 - Operating temperature: -25...+70°C
 - Storage temperature: -40...+85°C
- Degree of protection:
 - Per IEC/EN: IP66, IP67 and IP69K
 - Per UL: Type 1, 2, 3R, 4, 4X, 12, 12K.

Materials

An aluminium and zinc alloy (zama) is used for the metal part whereas plastic parts are made of polyamide.

Mechanical endurance

- Operating force: <0.5kg/1.1lb (actuator).
Mechanical life:
- Spring return actuators: 5,000,000 cycles
 - Push-push actuators: 500,000 cycles.

Mounting adapter

See page 7-36.
Type: LPXAU120M.
The adapter is fixed to the mounting surface by means of incorporated screws (Tmax = 0.7Nm/6.1lb.in).
Actuators latch onto the mounting adapter by simple rotation.

Contact elements for spring return button actuators

See page 7-36 and 7-38.

Type	Termination
1NO	LPXC10 Screw
	LPXCF10 Faston
	LPXCS10 Spring clamp
1EM	LPXC10A Screw
1NC	LPXC01 Screw
	LPXCF01 Faston
	LPXCS01 Spring clamp
1LB	LPXC01D Screw

Front-mount types snap onto LPXAU120M mounting adapter (to purchase separately).
Up to 9 contacts can be fitted: 3 each on the left, middle and right, one behind the other.
The LPXAU120M mounting adapter can also be fitted internally to the cover of the LPZ... control station with up to 3 elements per actuator.

1NO	LPXC10	Screw
	LPXCF10	Faston
	LPXCS10	Spring clamp
1EM	LPXC10A	Screw
1NC	LPXC01	Screw
	LPXCF01	Faston
	LPXCS01	Spring clamp
1LB	LPXC01D	Screw

Base mount types snap into LPZP... control station base.
See example on page 7-38.

Up to 3 contacts can be fitted per control station.

1NO	LPXCB10	Screw
1NC	LPXCB01	Screw

Contact elements for push-push button actuators

See page 7-37.
Type: LPXC10A (1EM)
LPXC01 (1NC)

Contacts snap onto the mounting adapter which can also be used with LPZ... control stations.
Up to 6 contacts can be fitted: 2 each on the left, middle or right; up to 3 elements can be fitted to the adapter when used with the LPZ... control station.

All these actuators are standard supplied with action plug for middle contacts.

Certifications and compliance

Certifications: cULus, EAC, RINA.
Compliant with standards: IEC/EN/BS 60947-1, IEC/EN/BS 60947-5-1, UL508, CSA C22.2 n° 14.

7 Pushbuttons and selector switches

PLatinum series
Ø22mm metal

Mechanical reset buttons, complete unit, spring return



LPSR1196

new

Order code	Colour	Qty per pkg	Wt
		n°	[kg]
Flush (5.2mm/0.2" stroke). Adjustable length 0-150mm/5.9". Complete with shaft (without mounting adapter). Spring return.			
LPSR1002	Black	5	0.044
LPSR1003	Green	5	0.044
LPSR1004	Red	5	0.044
LPSR1006	Blue	5	0.044
LPSR1196	Blue (RESET)	5	0.044
Extended (5.2mm/0.2" stroke). Adjustable length 0-150mm/5.9". Complete with shaft (without mounting adapter). Spring return.			
LPSR2004	Red	1	0.046

① With "RESET" caption on actuator.
E.g. Not suitable for LPZ... control stations.

Pushbutton actuators, spring return, with symbol



LPSB11...



LPSB21...

new

Order code	Symbol	Colour	Qty per pkg	Wt
			n°	[kg]
Flush (without mounting adapter). Spring return.				
LPSB1102	0	Black	5	0.031
LPSB1104		Red	5	0.031
LPSB1113	I	Green	5	0.031
LPSB1118		White	5	0.031
LPSB1123	II	Green	1	0.031
LPSB1128		White	1	0.031
LPSB1132	STOP	Black	1	0.031
LPSB1134		Red	5	0.031
LPSB1142	← ①	Black	5	0.031
LPSB1148	← ①	White	5	0.031
LPSB1152	↑ ②	Black	5	0.031
LPSB1158	↑ ②	White	5	0.031
LPSB1163	START	Green	5	0.031
LPSB1168		White	1	0.031
LPSB1176	R	Blue	1	0.031
LPSB1178		White	1	0.031
LPSB1196	RESET	Blue	5	0.031
LPSB1502	⚡	Black	5	0.031
LPSB1512	⚡	Black	5	0.031

Extended (without mounting adapter). Spring return.

LPSB2102	0	Black	5	0.033
LPSB2104		Red	5	0.033
LPSB2132	STOP	Black	1	0.033
LPSB2134		Red	5	0.033

① Arrow symbol can be used to indicate right or left.
② Arrow symbol can be used to indicate up or down.

Pushbutton actuators, spring return, with special symbols



LPSB...

new

Order code	Symbol	Colour	Qty per pkg	Wt
①②			n°	[kg]
Spring return (without mounting adapter).				
LPSB①②18③	⚡	③	50	0.033
LPSB①②34③	MAN	③	50	0.033
LPSB①②35③	AUTO	③	50	0.033
LPSB①②22③	↗	③	50	0.033
LPSB①②23③	⏏	③	50	0.033

Note: for other symbols see page 7-35.

- ① Add letter "L" if illuminated type is required.
- ② For the type of actuator, add: 1 for flush or 2 for extended.
- ③ Add the actuator colour: 2 black only for non-illuminated type; 3 green, 4 red, 5 yellow, 6 blue, 8 white or 7 transparent for illuminated version.
- ④ Products available on specific request for a minimum multiple quantity of 50 pieces per type.
- ⑤ Consult Technical support for assistance; see contact details or inside front cover.
- ⑥ Symbol indicating dangerous voltage (IEC 60417 5036-a).

Examples of complete order codes:

LPSB2258 – extended non-illuminated white pushbutton with + symbol;

LPSB1685 – flush illuminated yellow pushbutton actuator with ⚡ symbol.

Operational characteristics

- Any mounting position allowed
- Ambient conditions:
 - Operating temperature: -25...+70°C
 - Storage temperature: -40...+85°C
- Degree of protection:
 - Per IEC/EN: IP66, IP67 and IP69K
 - Per UL: Type 1, 2, 3R, 4, 4X, 12, 12K.

Materials

An aluminium and zinc alloy (zama) is used for the metal part whereas plastic parts are made of polyamide.

Mechanical endurance

Operating force: <0.5kg/1.1lb (actuator).
Mechanical life: 5,000,000 cycles.

Mounting adapter

See page 7-36.

Type: LPXAU120M.

The adapter is fixed to the mounting surface by means of incorporated screws (Tmax = 0.7Nm/6.1lb.in).

Actuators latch onto the mounting adapter by simple rotation.

Contact elements for LPSR... mechanical reset buttons

See page 7-37 and 7-38.

Type	Termination
Front-mount types snap onto LPXAU120M mounting adapter (to purchase separately). Up to 6 contacts can be fitted: 2 each on the left and right, one behind the other.	
1NO	LPXC10 Screw LPXCF10 Faston LPXCS10 Spring clamp
1EM	LPXC10A Screw
1NC	LPXC01 Screw LPXCF01 Faston LPXCS01 Spring clamp
1LB	LPXC01D Screw

Contact elements for spring return button actuators

See page 7-37 and 7-38.

Type	Termination
Front-mount types snap onto LPXAU120M mounting adapter (to purchase separately). Up to 9 contacts can be fitted: 3 each on the left, middle and right, one behind the other. The LPXAU120M mounting adapter can also be fitted internally to the cover of the LPZ... control station with up to 3 elements per actuator.	
1NO	LPXC10 Screw LPXCF10 Faston LPXCS10 Spring clamp
1EM	LPXC10A Screw
1NC	LPXC01 Screw LPXCF01 Faston LPXCS01 Spring clamp
1LB	LPXC01D Screw

Base mount types snap into LPZP... control station base. See example on page 7-38.

Up to 3 elements can be fitted to the adapter when used with the LPZ... control station.

1NO	LPXCB10	Screw
1NC	LPXCB01	Screw

All LPSB actuators are standard supplied with action plug for middle contacts.

Certifications and compliance

Certifications: cULus, EAC, RINA.

Compliant with standards: IEC/EN/BS 60947-1, IEC/EN/BS 60947-5-1, UL508, CSA C22.2 n° 14.

7 Pushbuttons and selector switches

PLatinum series
Ø22mm metal



INDEX

Mushroom head pushbutton actuators



LPSB614...



LPSB616...



LPSB6744



LPSB6634



LPSB6644



LPSB6844

new

new

Order code	Colour	Qty per pkg	Wt
		n°	[kg]

SPRING RETURN.
Ø40mm/1.57" (without mounting adapter).

LPSB6142	Black	5	0.038
LPSB6143	Green	5	0.038
LPSB6144	Red	5	0.038
LPSB6145	Yellow	5	0.038
LPSB6146	Blue	5	0.038

Ø60mm/2.36" (without mounting adapter).

LPSB6162	Black	5	0.044
LPSB6163	Green	1	0.044
LPSB6164	Red	5	0.044
LPSB6165	Yellow	1	0.044
LPSB6166	Blue	1	0.044

LATCH, PULL TO RELEASE.
Ø40mm/1.57" (without mounting adapter).
For normal stopping.

LPSB6742	Black	5	0.102
----------	-------	---	-------

For emergency stopping, ISO 13850 compliant.

LPSB6744	Red	5	0.102
----------	-----	---	-------

LATCH, TURN TO RELEASE.
Ø30mm/1.18" (without mounting adapter).
For emergency stopping, ISO 13850 compliant.

LPSB6634	Red	5	0.048
----------	-----	---	-------

Ø40mm/1.57" (without mounting adapter).
For normal stopping.

LPSB6642	Black	5	0.051
----------	-------	---	-------

Ø40mm/1.57" (without mounting adapter).
For emergency stopping, ISO 13850 compliant.

LPSB6644	Red	5	0.084
----------	-----	---	-------

LATCH, TURN KEY TO RELEASE.
Ø40mm/1.57" (without mounting adapter). Key code n° 455.
For normal stopping.

LPSB6842	Black	5	0.088
----------	-------	---	-------

LPSB6842R	Black	1	0.088
-----------	-------	---	-------

For emergency stopping, ISO 13850 compliant.

LPSB6844	Red	5	0.088
----------	-----	---	-------

LPSB6844R	Red	1	0.088
-----------	-----	---	-------

① Versions with different key codes.
Complete with the numeric code of the key.
The following versions are available: 421E, 458A, 520E, 3131A, 3433E.
Example of complete code: LPSB6844R421E.

Normal operation of auto-monitor contact mounted on surface or on cover of control stations

In case of detachment of only the contact element and/or of the mounting adapter with contact element

With contact type LPXC01SM (1NC)

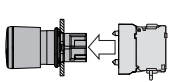

When the button is fully pressed, contact 1-2 opens and remains in this state until the button is released.
Contact 3-4 in series does not change state.

If the contact LPXC01SM detaches from the actuator due to strong vibrations or shock, the equipment can be restored to operating state only when proper mounting of the contact with the actuator is re-established resulting in contact 3-4 closing.

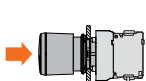
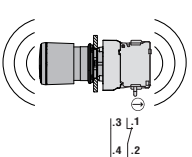

When the button is fully pressed, contact 1-2 opens and remains in this state until the button is released.
Contact 3-4 in series does not change state.

With contact type LPXC02SM (2NC)

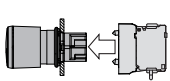

When the button is fully pressed, both contacts 1-2 open and remain in this state until the button is released.
Contact 3-4 in series does not change state.

If the contact LPXC02SM detaches from the actuator due to strong vibrations or shock, the equipment can be restored to operating state only when proper mounting of the contact with the actuator is re-established resulting in contact 3-4 closing.

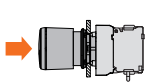
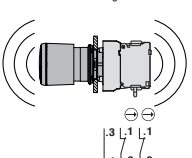

When the button is fully pressed, both contacts 1-2 open and remain in this state until the button is released.
Contact 3-4 in series does not change state.

Operational characteristics

- Any mounting position allowed
- Ambient conditions:
 - Operating temperature: -25...+70°C
 - Storage temperature: -40...+85°C
- Degree of protection:
 - Per IEC/EN: IP66, IP67 and IP69K
 - Per UL: Type 1, 2, 3R, 4, 4X, 12, 12K.

Materials

An aluminium and zinc alloy (zama) is used for the metal part whereas plastic parts are made of polyamide.

Mechanical endurance

- Operating force: <0.5kg/1.1lb (actuator).
- Mechanical life:
 - Spring return mushroom-head actuators: 5,000,000 cycles
 - Latch mushroom-head actuators: 300,000 cycles.

Mounting adapter

See page 7-36.
Type: LPXAU120M.
The adapter is fixed to the mounting surface by means of incorporated screws (Tmax = 0.7Nm/6.1lb.in).
Actuators latch onto the mounting adapter by simple rotation.

Contact elements

See page 7-37 and 7-38.

Type	Termination		
Front-mount types snap onto LPXAU120M mounting adapter (to purchase separately). For SPRING RETURN types, up to 9 contacts can be fitted: 3 each on the left, middle and right, one behind the other. For LATCH types, up to 4 contacts can be fitted. The LPXAU120M mounting adapter can also be fitted internally to the cover of the LPZ... control station with up to 3 elements per actuator.	1NO	LPXC10	Screw
		LPXCF10	Faston
		LPXCS10	Spring clamp
Base mount types snap into LPZP... control station base. See example on page 7-38. Up to 3 elements can be fitted to the adapter when used with the LPZ... control station.	1EM	LPXC10A	Screw
	1NC	LPXC01	Screw
		LPXCF01	Faston
	LPXCS01	Spring clamp	
1LB	LPXC01D	Screw	
1NO	LPXCB10	Screw	
	LPXCB01	Screw	

AUTO-MONITOR CONTACT with MUSHROOM-HEAD LATCH TYPES only: 2 elements max of this type can be mounted.

Extra two contacts can be fitted on the right.
Two elements per actuator can be fixed internally on the cover surface of LPZ... control stations of which one auto-monitor type. No LED element can be installed.

Auto-monitor 1NC	LPXC01SM	Screw (2 stacked in the middle - LPXAU120M pos.1/3-4/6)
1NO	LPXC10	Screw (2 stacked on the right)
	LPXCF10	Faston (2 stacked on the right)
	LPXCS10	Spring clamp (2 stacked on the right)
1NC	LPXC01	Screw (2 stacked on the right)
	LPXCF01	Faston (2 stacked on the right)
	LPXCS01	Spring clamp (2 stacked on the right)
Auto-monitor 2NC	LPXC02SM	Screw (2 stacked)

All these actuators are standard-supplied with action plug for middle contacts.

Certifications and compliance

Certifications: cULus, EAC, RINA.
Compliant with standards: IEC/EN/BS 60947-1, IEC/EN/BS 60947-5-1, UL508, CSA C22.2 n° 14.

7 Pushbuttons and selector switches

PLatinum series
Ø22mm metal

Double-touch actuators, spring return



LPSB71...



LPSB72...

new

Order code	Colour	Symbols	Qty per pkg	Wt
			n°	[kg]

Two flush pushbuttons (without mounting adapter). Both spring return.

LPSB7112	Black/Red	—	5	0.035
LPSB7113	Green/Red	—	5	0.035
LPSB7114	White/Black	—	5	0.035
LPSB7122	Black/Red	I-O	5	0.035
LPSB7123	Green/Red	I-O	5	0.035
LPSB7124	White/Black	I-O	5	0.035
LPSB7133	Green/Red	Start/Stop	5	0.035
LPSB7191	Black/Black	↑ ↓	5	0.035

One extended and one flush pushbuttons (without mounting adapter). Both spring return.

LPSB7212	Black/Red	—	1	0.035
LPSB7213	Green/Red	—	5	0.035
LPSB7214	White/Black	—	1	0.035
LPSB7222	Black/Red	I-O	5	0.035
LPSB7223	Green/Red	I-O	5	0.035
LPSB7224	White/Black	I-O	1	0.035
LPSB7233	Green/Red	Start/Stop	5	0.035

Triple-touch actuators, spring return



LPSB73...

new

Order code	Symbols	Qty per pkg	Wt
		n°	[kg]

One middle extended buttons (without mounting adapter). Spring return.

LPSB7345	↑ STOP ↓	5	0.035
LPSB7355	↑ STOP ↓	5	0.035
LPSB7365	→ STOP ←	5	0.035
LPSB7375	↗ STOP ↙	5	0.035

Operational characteristics

- Any mounting position allowed
- Ambient conditions:
 - Operating temperature: -25...+70°C
 - Storage temperature: -40...+85°C
- Degree of protection:
 - Per IEC/EN: IP66, IP67 and IP69K
 - Per UL: Type 1, 2, 3R, 4, 4X, 12, 12K.

Materials

An aluminium and zinc alloy (zama) is used for the metal part whereas plastic parts are made of polyamide.

Mechanical endurance

Operating force: <0.5kg/1.1lb (actuator).
Mechanical life: 1,000,000 cycles.

Mounting adapter

See page 7-36.

Type: LPXAU120M.

The adapter is fixed to the mounting surface by means of incorporated screws (Tmax = 0.7Nm/6.1lb.in).

Actuators latch onto the mounting adapter by simple rotation.

Contact elements

See page 7-37 and 7-38.

Type	Termination
------	-------------

Front-mount types snap onto LPXAU120M mounting adapter (to purchase separately).

For DOUBLE-TOUCH actuators, up to 9 contacts can be fitted: 3 each on the left, middle and right, one behind the other. For TRIPLE-TOUCH actuators, up to 9 contacts can be fitted: 3 each on the left, middle and right, one behind the other.

The LPXAU120M mounting adapter can also be fitted internally to the cover of the LPZ... control station with up to 3 elements for double-touch and 3 elements for triple-touch actuators.

1NO	LPXC10	Screw
	LPXCF10	Faston
	LPXCS10	Spring clamp
1EM	LPXC10A	Screw
1NC	LPXC01	Screw
	LPXCF01	Faston
	LPXCS01	Spring clamp
1LB	LPXC01D	Screw

Base mount types snap into LPZP... control station base.

See example on page 7-38.

For DOUBLE-TOUCH actuators, 2 contacts need to be fitted, one on the left and one on the right.

For TRIPLE-TOUCH actuators, 3 contacts need to be fitted: one each on the left, middle and right.

1NO	LPXCB10	Screw
1NC	LPXCB01	Screw

All these actuators are standard-supplied with action plug for middle contacts.

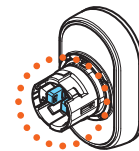

The middle contact activation, with respect to the right and left side contact, can be changed by the user, if required, by removing one mechanism pin. Consult the relative instructions available online in the Downloads section at www.LovatoElectric.com.

Certifications and compliance

Certifications: cULus, EAC, RINA.

Compliant with standards: IEC/EN/BS 60947-1, IEC/EN/BS 60947-5-1, UL508, CSA C22.2 n° 14.

7 Pushbuttons and selector switches

PLatinum series
Ø22mm metal



INDEX

Selector switch actuators lever



LPSS1...

new

Order code	Type of positions	Qty per pkg	Wt
		n°	[kg]
2 positions (without mounting adapter).			
LPSS120		5	0.042
LPSS121		5	0.042
3 positions (without mounting adapter).			
LPSS130		5	0.042
LPSS131		5	0.042
LPSS132		5	0.042
LPSS133		5	0.042

Selector switch actuators long lever



LPSS2...

new

Order code	Type of positions	Qty per pkg	Wt
		n°	[kg]
2 positions (without mounting adapter).			
LPSS220		5	0.045
LPSS221		5	0.045
3 positions (without mounting adapter).			
LPSS230		5	0.045
LPSS231		5	0.045
LPSS232		5	0.045
LPSS233		5	0.045

Selector switch actuators key (Ronis)



LPSS3...

new

Order code	Type of positions	Qty per pkg	Wt
		n°	[kg]
2 positions (without mounting adapter).			
LPSS320		5	0.065
LPSS320R [ⓐ]		1	0.065
LPSS321		5	0.065
LPSS321R [ⓐ]		1	0.065
LPSS340		5	0.065
LPSS340R [ⓐ]		1	0.065
3 positions (without mounting adapter).			
LPSS330		5	0.065
LPSS330R [ⓐ]		1	0.065
LPSS331		5	0.065
LPSS331R [ⓐ]		1	0.065
LPSS332 [ⓐ]		5	0.065
LPSS332R ^{ⓐⓑ}		1	0.065
LPSS333 [ⓐ]		5	0.065
LPSS333R ^{ⓐⓑ}		1	0.065
LPSS350		5	0.065
LPSS350R [ⓐ]		1	0.065
LPSS360		5	0.065
LPSS360R [ⓐ]		1	0.065
LPSS370 [ⓐ]		5	0.065
LPSS370R ^{ⓐⓑ}		1	0.065
LPSS380 [ⓐ]		5	0.065
LPSS380R ^{ⓐⓑ}		1	0.065
LPSS390 [ⓐ]		5	0.065
LPSS390R ^{ⓐⓑ}		1	0.065

ⓐ Versions with different key codes. Complete with the numeric code of the key. The following versions are available: 421E, 458A, 520E, 3131A, 3433E. Example of complete code: LPSS320R421E.
 ⓑ Available only on specific request.

Operational characteristics

- Any mounting position allowed
- Standard key types supplied with Ronis key code n° 455
- Ambient conditions:
 - Operating temperature: -25...+70°C
 - Storage temperature: -40...+85°C
- Degree of protection:
 - Per IEC/EN: IP66, IP67 and IP69K
 - Per UL: Type 1, 2, 3R, 4, 4X, 12, 12K.

Materials

An aluminium and zinc alloy (zama) is used for the metal part whereas plastic parts are made of polyamide.

Mechanical endurance

Mechanical life: 1,000,000 cycles.

Mounting adapter

See page 7-36.

Type: LPXAU120M.

The adapter is fixed to the mounting surface by means of incorporated screws (Tmax = 0.7Nm/6.1lb.in).

Actuators latch onto the mounting adapter by simple rotation.

Contact elements

See page 7-37 and 7-38.

Type	Termination
1NO	LPXC10 Screw
	LPXCF10 Faston
	LPXCS10 Spring clamp
1EM	LPXC10A Screw
1NC	LPXC01 Screw
	LPXCF01 Faston
	LPXCS01 Spring clamp
1LB	LPXC01D Screw

Front-mount types snap onto LPXAU120M mounting adapter (to purchase separately). Up to 6 contacts can be fitted: 2 each on the left, middle and right or 3 each on the left and right, one behind the other. The LPXAU120M mounting adapter can also be fitted internally to the cover of the LPZ... control station with up to 3 elements per actuator.

Type	Termination
1NO	LPXC10 Screw
	LPXCF10 Faston
	LPXCS10 Spring clamp
1EM	LPXC10A Screw
1NC	LPXC01 Screw
	LPXCF01 Faston
	LPXCS01 Spring clamp
1LB	LPXC01D Screw

Base mount types snap into LPZP... control station base.

See example on page 7-38.

Up to 3 elements can be fitted to the adapter when used with the LPZ... control station.

Type	Termination
1NO	LPXCB10 Screw
1NC	LPXCB01 Screw

All these actuators are standard-supplied with action plug for middle contacts.

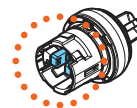

The middle contact activation, with respect to the right and left side contact, can be changed by the user, if required, by removing one mechanism pin. Consult the relative instructions available online in the Downloads section at www.LovatoElectric.com.

Type of position

- Maintained position.
- Spring return position.
- Key extraction position.

Rotation angles

2 positions



3 positions



Certifications and compliance

Certifications: cULus, EAC, RINA.

Compliant with standards: IEC/EN/BS 60947-1, IEC/EN/BS 60947-5-1, UL508, CSA C22.2 n° 14.

7 Pushbuttons and selector switches

PLatinum series
Ø22mm metal

Selector switch actuators knob



LPSS4...

new

Order code	Type of positions	Qty per pkg	Wt
		n°	[kg]
2 positions (without mounting adapter).			
LPSS420	∇	5	0.042
LPSS421	∇	5	0.042
3 positions (without mounting adapter).			
LPSS430	∇	5	0.042
LPSS431	∇	5	0.042
LPSS432	∇	5	0.042
LPSS433	∇	5	0.042

Contact activation

2-position selector switch

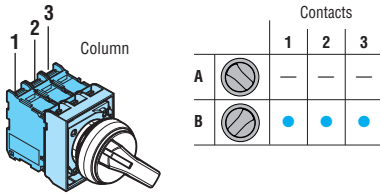

3-position selector switch

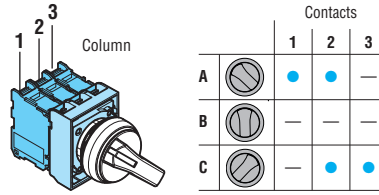

2-position selector switch

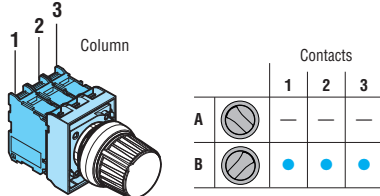

3-position selector switch

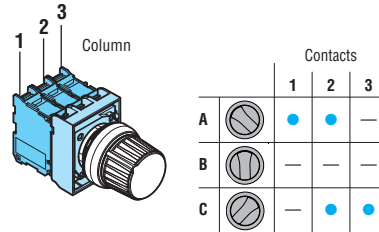

Operational characteristics

- Any mounting position allowed
- Ambient conditions:
 - Operating temperature: -25...+70°C
 - Storage temperature: -40...+85°C
- Degree of protection:
 - Per IEC/EN: IP66, IP67 and IP69K
 - Per UL: Type 1, 2, 3R, 4, 4X, 12, 12K.

Materials

An aluminium and zinc alloy (zama) is used for the metal part whereas plastic parts are made of polyamide.

Mechanical endurance

Mechanical life: 1,000,000 cycles.

Mounting adapter

See page 7-36.

Type: LPXAU120M.

The adapter is fixed to the mounting surface by means of incorporated screws (Tmax = 0.7Nm/6.1lb.in).

Actuators latch onto the mounting adapter by simple rotation.

Contact elements

See page 7-37 and 7-38.

Type	Termination
Front-mount types snap onto LPXAU120M mounting adapter (to purchase separately). Up to 6 contacts can be fitted: 2 each on the left, middle and right or 3 each on the left and right, one behind the other. The LPXAU120M mounting adapter can also be fitted internally to the cover of the LPZ... control station with up to 3 elements per actuator.	

1NO	LPXC10	Screw
	LPXCF10	Faston
	LPXCS10	Spring clamp
1EM	LPXC10A	Screw
1NC	LPXC01	Screw
	LPXCF01	Faston
	LPXCS01	Spring clamp
1LB	LPXC01D	Screw

Base mount types snap into LPZP... control station base.

See example on page 7-38.

Up to 3 elements can be fitted to the adapter when used with the LPZ... control station.

1NO	LPXCB10	Screw
1NC	LPXCB01	Screw

All these actuators are standard-supplied with action plug for middle contacts.

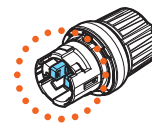

The middle contact activation, with respect to the right and left side contact, can be changed by the user, if required, by removing one mechanism pin. Consult the relative instructions available online in the Downloads section at www.LovatoElectric.com.

Type of position

- ∇ Maintained position.
- ∇ Spring return position.

Rotation angles

2 positions



3 positions



Certifications and compliance

Certifications: cULus, EAC, RINA.

Compliant with standards: IEC/EN/BS 60947-1, IEC/EN/BS 60947-5-1, UL508, CSA C22.2 n° 14.

Illuminated button actuators, spring return



LPSBL10...



LPSBL20...

new

Order code	Colour	Qty per pkg	Wt
		n°	[kg]
Flush (without mounting adapter). Spring return.			
LPSBL103	Green	5	0.030
LPSBL104	Red	5	0.030
LPSBL105	Yellow	5	0.030
LPSBL106	Blue	5	0.030
LPSBL107	Transparent	5	0.030
Extended (without mounting adapter). Spring return.			
LPSBL203	Green	5	0.032
LPSBL204	Red	5	0.032
LPSBL205	Yellow	5	0.032
LPSBL206	Blue	5	0.032
LPSBL207	Transparent	5	0.032

Illuminated push-push button actuators



LPSQL10...



LPSQL20...

new

Order code	Colour	Qty per pkg	Wt
		n°	[kg]
Flush (without mounting adapter). Push on-push off.			
LPSQL103	Green	5	0.030
LPSQL104	Red	5	0.030
LPSQL105	Yellow	5	0.030
LPSQL106	Blue	5	0.030
LPSQL107	Transparent	5	0.030
Extended (without mounting adapter). Push on-push off.			
LPSQL203	Green	5	0.032
LPSQL204	Red	5	0.032
LPSQL205	Yellow	5	0.032
LPSQL206	Blue	5	0.032
LPSQL207	Transparent	5	0.032

ⓘ Use contact elements LPXC10A (EM) and LPXC01 (NC) only.
Contact elements LPXC10 (NO) and LPXC01D (LB) cannot be fitted on these actuators.

Illuminated mushroom head button actuators



LPSBL614...



LPSBL664...

new

Order code	Colour	Qty per pkg	Wt
		n°	[kg]
SPRING RETURN. Ø40mm/1.57" (without mounting adapter).			
LPSBL6143	Green	5	0.040
LPSBL6144	Red	5	0.040
LPSBL6145	Yellow	5	0.040
LPSBL6146	Blue	5	0.040
LPSBL6148	White	1	0.040
LATCH, TURN TO RELEASE. Ø40mm/1.57" (without mounting adapter). For normal stopping.			
LPSBL6643	Green	1	0.045
LPSBL6645	Yellow	1	0.045
LPSBL6646	Blue	1	0.045
For emergency stopping, ISO 13850 compliant.			
LPSBL6644	Red	5	0.045

Operational characteristics

- Any mounting position allowed
- Ambient conditions:
 - Operating temperature: -25...+70°C
 - Storage temperature: -40...+85°C
- Degree of protection:
 - Per IEC/EN: IP66, IP67 and IP69K
 - Per UL: Type 1, 2, 3R, 4, 4X, 12, 12K.

Materials

An aluminium and zinc alloy (zama) is used for the metal part whereas plastic parts are made of polyamide.

Mechanical endurance

- Operating force: <0.5kg/1.1lb (actuator).
Mechanical life:
- Spring return actuators: 5,000,000 cycles
 - Push-push actuators: 500,000 cycles
 - Spring return mushroom-head actuators: 5,000,000 cycles
 - Latch mushroom-head actuators: 300,000 cycles.

Mounting adapter

See page 7-36.
Type: LPXAU120M.
The adapter is fixed to the mounting surface by means of incorporated screws (Tmax = 0.7Nm/6.1lb.in).
Actuators latch onto the mounting adapter by simple rotation.

Contact elements for illuminated spring return and mushroom-head latch actuators

See page 7-37 and 7-38.

Type	Termination	
1NO	LPXC10	Screw
	LPXCF10	Faston
	LPXCS10	Spring clamp
1EM	LPXC10A	Screw
1NC	LPXC01	Screw
	LPXCF01	Faston
	LPXCS01	Spring clamp
1LB	LPXC01D	Screw

Base mount types snap into LPZP... control station base.
See example on page 7-38.
Up to 2 elements per actuator can also be fitted internally to the cover of the LPZ... control station in addition to the LED element in the middle position.

1NO	LPXCB10	Screw
1NC	LPXCB01	Screw

Contact elements for illuminated push-push button actuators

See page 7-37.
Type: LPXC10A (1EM)
LPXC01 (1NC)
Contacts snap onto the adapter also internally on the cover surface of LPZ... control stations.
Up to 4 contacts can be fitted: 2 each on the left and right, one behind the other; up to 2 elements per control station actuator in addition to the LED element in the middle position.

LED light elements

See pages 7-39 to 42.

Certifications and compliance

Certifications: cULus, EAC, RINA.
Compliant with standards: IEC/EN/BS 60947-1, IEC/EN/BS 60947-5-1, UL508, CSA C22.2 n° 14.

7 Pushbuttons and selector switches

PLatinum series
Ø22mm metal

Double-touch actuators, spring return, white indicator



LPSBL71...



LPSBL72...

new

Order code	Colour	Symbol	Qty per pkg n°	Wt [kg]
Two flush pushbuttons (without mounting adapter). Both spring return.				
LPSBL7112	Black/Red	—	5	0.035
LPSBL7113	Green/Red	—	5	0.035
LPSBL7114	White/Black	—	1	0.035
LPSBL7122	Black/Red	I-O	5	0.035
LPSBL7123	Green/Red	I-O	5	0.035
LPSBL7124	White/Black	I-O	5	0.035
LPSBL7133	Green/Red	Start/Stop	5	0.035
LPSBL7191	Black/Black	↑ ↓	5	0.035

Order code	Colour	Symbol	Qty per pkg n°	Wt [kg]
One extended and one flush pushbuttons (without mounting adapter). Both spring return.				
LPSBL7212	Black/Red	—	1	0.035
LPSBL7213	Green/Red	—	5	0.035
LPSBL7214	White/Black	—	1	0.035
LPSBL7222	Black/Red	I-O	1	0.035
LPSBL7223	Green/Red	I-O	5	0.035
LPSBL7224	White/Black	I-O	5	0.035
LPSBL7233	Green/Red	Start/Stop	5	0.035

Illuminated selector switch actuators



LPSSL1...

new

Order code	Colour	Type of positions	Qty per pkg n°	Wt [kg]
2 positions (without mounting adapter).				
LPSSL1203	Green	∨	5	0.030
LPSSL1204	Red		5	0.030
LPSSL1205	Yellow		5	0.030
LPSSL1206	Blue		5	0.030
LPSSL1208	White		5	0.030
LPSSL1213	Green	∩	5	0.030
LPSSL1214	Red		1	0.030
LPSSL1215	Yellow		1	0.030
LPSSL1216	Blue		1	0.030
LPSSL1218	White		5	0.030

Order code	Colour	Type of positions	Qty per pkg n°	Wt [kg]
3 positions (without mounting adapter).				
LPSSL1303	Green	∨	5	0.030
LPSSL1304	Red		5	0.030
LPSSL1305	Yellow		5	0.030
LPSSL1306	Blue		5	0.030
LPSSL1308	White		5	0.030
LPSSL1313	Green	∩	5	0.030
LPSSL1314	Red		1	0.030
LPSSL1315	Yellow		1	0.030
LPSSL1316	Blue		1	0.030
LPSSL1318	White		5	0.030
LPSSL1323	Green	∩	5	0.030
LPSSL1324	Red		1	0.030
LPSSL1325	Yellow		1	0.030
LPSSL1326	Blue		1	0.030
LPSSL1328	White		5	0.030
LPSSL1333	Green	∩	5	0.030
LPSSL1334	Red		1	0.030
LPSSL1335	Yellow		1	0.030
LPSSL1336	Blue		1	0.030
LPSSL1338	White		5	0.030

Contact activation of 2-position selector switch

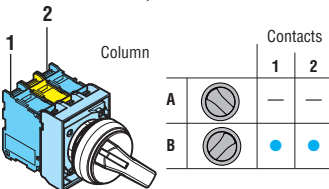

Contact activation of 3-position selector switch

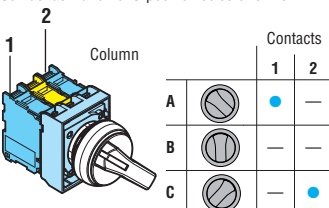

Operational characteristics

- Any mounting position allowed
- Ambient conditions:
 - Operating temperature: -25...+70°C
 - Storage temperature: -40...+85°C
- Degree of protection:
 - Per IEC/EN: IP66, IP67 and IP69K
 - Per UL: Type 1, 2, 3R, 4, 4X, 12, 12K.

Materials

An aluminium and zinc alloy (zama) is used for the metal part whereas plastic parts are made of polyamide.

Mechanical endurance

- Operating force: <0.5kg/1.1lb (actuator).
Mechanical life:
- Double-touch: 1,000,000 cycles.
 - Selector switches: 1,000,000 cycles.

Mounting adapter

See page 7-36.
Type: LPXAU120M.
The adapter is fixed to the mounting surface by means of incorporated screws (Tmax = 0.7Nm/6.1lb.in). Actuators latch onto the mounting adapter by simple rotation.

Contact elements

See page 7-37 and 7-38.

Type	Termination
Front-mount types snap onto LPXAU120M mounting adapter (to purchase separately).	
For DOUBLE-TOUCH types, up to 6 contacts can be fitted: 3 each on the left and right, one behind the other.	
For SELECTOR SWITCHES, up to 4 contacts can be fitted: 2 each on the left and right, one behind the other.	
The LPXAU120M mounting adapter can also be fitted internally to the cover of the LPZ... control station with up to 2 elements per actuator in addition to the LED element in the middle position.	
1NO	LPXC10 Screw
	LPXCF10 Faston
	LPXCS10 Spring clamp
1EM	LPXC10A Screw
1NC	LPXC01 Screw
	LPXCF01 Faston
	LPXCS01 Spring clamp
1LB	LPXC01D Screw

Base mount types snap into LPZP... control station base. See example on page 7-38.		
Up to 2 elements per actuator can also be fitted internally to the cover of the LPZ... control station in addition to the LED element in the middle position.		
1NO	LPXCB10	Screw
1NC	LPXCB01	Screw

Selector switch type of positions

- ∨ Maintained position.
- ∩ Spring return position.

Selector switch rotation angles



LED light elements

See pages 7-39 to 42.

Certifications and compliance

Certifications: cULus, EAC, RINA.
Compliant with standards: IEC/EN/BS 60947-1, IEC/EN/BS 60947-5-1, UL508, CSA C22.2 n° 14.

Pilot light heads



LPSL...

new

Order code	Colour	Qty per pkg	Wt
		n°	[kg]
Without mounting adapter.			
LPSL3	Green	5	0.029
LPSL4	Red	5	0.029
LPSL5	Yellow	5	0.029
LPSL6	Blue	5	0.029
LPSL7	Transparent	5	0.029
LPSL1187	Transparent ⚡ ⚠	5	0.029

⚠ With symbol indicating dangerous voltage (IEC/EN 60417 5036-a).

Operational characteristics

- Any mounting position allowed
- Ambient conditions:
 - Operating temperature: -25...+70°C
 - Storage temperature: -40...+85°C
- Degree of protection:
 - Per IEC/EN: IP66, IP67 and IP69K
 - Per UL: Type 1, 2, 3R, 4, 4X, 12, 12K.

Materials

An aluminium and zinc alloy (zama) is used for the metal part whereas plastic parts are made of polyamide.

Mounting adapter

See page 7-36.

Type: LPXAU120M.

The adapter is fixed to the mounting surface by means of incorporated screws (Tmax = 0.7Nm/6.1lb.in).

Actuators latch onto the mounting adapter by simple rotation.

LED light elements

See pages 7-39 to 42.

Certifications and compliance

Certifications: cULus, EAC, RINA.

Compliant with standards: IEC/EN/BS 60947-1, IEC/EN/BS 60947-5-1, UL508, CSA C22.2 n° 14.

7 Pushbuttons and selector switches

PLatinum series
Ø22mm metal

Joysticks



LPSJ4...
(without mechanical interlock)



LPSJ2...
(with mechanical interlock)

Accessories



LPXAU101

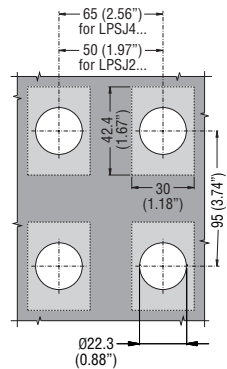

new

new

Order code	Type of positions	N° auxiliary elements	Qty per pkg	Wt
		NO	n°	[kg]

Without mechanical interlock. Complete with auxiliary contact. Label holder excluded.

LPSJ200		2	1	0.082
LPSJ201		2	1	0.082
LPSJ400		4	1	0.104
LPSJ401		4	1	0.104

With mechanical interlock in centre position. Complete with auxiliary contact. Label holder excluded.

LPSJ210		2	1	0.082
LPSJ211		2	1	0.082
LPSJ410		4	1	0.104
LPSJ411		4	1	0.104

Order code	Description	Qty per pkg	Wt
		n°	[kg]
LPXAU101	2-4 directional holder for adhesive legends	1	0.004

See page 7-48 for the complete list of available labels.

Operational characteristics

- Any mounting position allowed
- LPSJ2... types can be used with LPZ... control stations
- Ambient conditions:
 - Operating temperature: -25...+70°C
 - Storage temperature: -40...+85°C
- Degree of protection:
 - Per IEC/EN: IP66
 - Per UL: Type 1, 2, 3R, 4, 4X, 12, 12K
 - IP20 for contact elements.

Materials

An aluminium and zinc alloy (zama) is used for the metal parts whereas plastic parts are made of polyamide and polycarbonate. The sealing boot is made of NBR rubber.

Mechanical endurance

Mechanical life: 1,000,000 cycles.

General characteristics of contact elements

Wiping action and dual scraping-oscillating effect.
 IEC rated insulation voltage: 690V
 IEC rated thermal current I_{th}: 10A
 UL/CSA and IEC/EN/BS 60947-5-1 designation: A300 Q300.
 IEC/EN operational characteristics in AC15 category:

[V]	12	24	48	120	240
[A]	6	6	6	6	3

IEC/EN operational characteristics in DC13 category:

[V]	12	24	48	125	250
[A]	3	3	1.5	0.55	0.27

Short circuit protection fuse, max calibre: 10A gG/SC.

Contact resistance: ≤20mΩ.

Terminals: Clamp screw with washer

Maximum tightening torque: 1Nm/8.8lb.in.

Mounting adapter and contact elements

The joystick is standard supplied with the mounting adapter and contact elements.

The adapter is fixed to the mounting surface by means of incorporated screws (T_{max} = 0.7Nm/6.1lb.in).

The joystick latches onto the mounting adapter by simple rotation.

Contact elements snap onto the mounting adapter.

2 LPXC... contacts are mounted on joystick LPSJ2... type and 4 LPXC... contacts on LPSJ4... type.

The mounting adapter and contact elements of LPSJ2... types can be internally mounted on LPZ... control stations covers.

Certifications and compliance

Certifications: cULus, EAC, RINA.

Compliant with standards: IEC/EN/BS 60947-1, IEC/EN/BS 60947-5-1, UL508, CSA C22.2 n° 14.

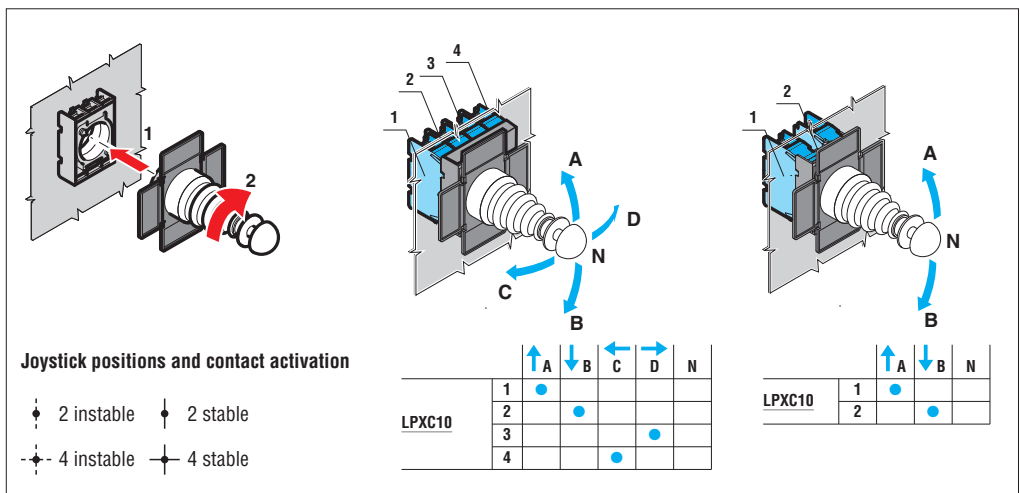

7 Pushbuttons and selector switches

PLatinum series
Ø30mm flat metal



INDEX

Pushbutton actuators, spring return



LPFB10...



LPFB20...

new

Order code	Colour	Qty per pkg n°	Wt [kg]
Flush (without mounting adapter). Spring return.			
LPFB102	Black	5	0.060
LPFB103	Green	5	0.060
LPFB104	Red	5	0.060
LPFB105	Yellow	5	0.060
LPFB106	Blue	5	0.060
LPFB108	White	5	0.060
Extended (without mounting adapter). Spring return.			
LPFB202	Black	5	0.062
LPFB203	Green	5	0.062
LPFB204	Red	5	0.062
LPFB205	Yellow	1	0.062
LPFB206	Blue	1	0.062
LPFB208	White	1	0.062

Push-push button actuators



LPFQ10...



LPFQ20...

new

Order code	Colour	Qty per pkg n°	Wt [kg]
Flush (without mounting adapter). Push on-push off.			
LPFQ102Ⓢ	Black	5	0.060
LPFQ103Ⓢ	Green	5	0.060
LPFQ104Ⓢ	Red	5	0.060
LPFQ105Ⓢ	Yellow	1	0.060
LPFQ106Ⓢ	Blue	1	0.060
LPFQ108Ⓢ	White	1	0.060
Extended (without mounting adapter). Push on-push off.			
LPFQ202Ⓢ	Black	5	0.062
LPFQ203Ⓢ	Green	5	0.062
LPFQ204Ⓢ	Red	5	0.062
LPFQ205Ⓢ	Yellow	1	0.062
LPFQ206Ⓢ	Blue	1	0.062
LPFQ208Ⓢ	White	1	0.062

Ⓢ Use contact elements LPXC10A (EM) and LPXC01 (NC) only.
Contact elements LPXC10 (NO) and LPXC01D (LB) cannot be fitted on these actuators.
For the number of contacts that can be fitted, see the indication here to the side.

Operational characteristics

- Any mounting position allowed
- Ambient conditions:
 - Operating temperature: -25...+70°C
 - Storage temperature: -40...+85°C
- Degree of protection:
 - Per IEC/EN: IP66, IP67 and IP69K
 - Per UL: Type 1, 2, 3R, 4, 4X, 12, 12K.

Materials

An aluminium and zinc alloy (zama) is used for the metal part whereas plastic parts are made of polyamide.

Mechanical endurance

- Operating force: <0.5kg/1.1lb (actuator).
Mechanical life:
- Spring return actuators: 5,000,000 cycles
 - Push-push actuators: 500,000 cycles.

Mounting adapter

See page 7-36.
Type: LPXAU120M.
The actuators fit into a Ø30mm/Ø1.18" hole. The fixing of the base to the mounting surface is made using the adapter supplied with the actuator and the screws incorporated in the base (Tmax = 0.7Nm/6.1lb.in).

Contact elements for spring return button actuators

See page 7-37 and 7-38.

Type	Termination	
1NO	LPXC10	Screw
	LPXCF10	Faston
	LPXCS10	Spring clamp
1EM	LPXC10A	Screw
1NC	LPXC01	Screw
	LPXCF01	Faston
	LPXCS01	Spring clamp
1LB	LPXC01D	Screw

Contact elements for push-push button actuators

See page 7-37.

Type: LPXC10A (1EM)
LPXC01 (1NC)

Up to 6 contacts can be fitted: 2 each on the left, middle and right, one behind the other.

All actuators are standard supplied with action plug for middle contacts.

Certifications and compliance

Certifications: cULus, EAC, RINA.
Compliant with standards: IEC/EN/BS 60947-1, IEC/EN/BS 60947-5-1, UL508, CSA C22.2 n° 14.

7 Pushbuttons and selector switches

PLatinum series
Ø30mm flat metal

Pushbutton actuators, spring return, with symbol



LPFB11...



LPFB21...

new

Order code	Symbol	Colour	Qty per pkg	Wt
			n°	[kg]
Flush (without mounting adapter). Spring return.				
LPFB1102	0	Black	5	0.060
LPFB1104		Red	5	0.060
LPFB1113	I	Green	5	0.060
LPFB1118		White	5	0.060
LPFB1123	II	Green	1	0.060
LPFB1128		White	1	0.060
LPFB1132	STOP	Black	1	0.060
LPFB1134		Red	5	0.060
LPFB1142		Black	5	0.060
LPFB1148	← ①	White	5	0.060
LPFB1152	↑ ②	Black	5	0.060
LPFB1158		White	5	0.060
LPFB1163	START	Green	5	0.060
LPFB1168		White	1	0.060
LPFB1176	R	Blue	1	0.060
LPFB1178		White	1	0.060
LPFB1196	RESET	Blue	5	0.060
LPFB1502	↔	Black	5	0.060
LPFB1512	↔	Black	5	0.060
Extended (without mounting adapter). Spring return.				
LPFB2102	0	Black	5	0.062
LPFB2104		Red	5	0.062
LPFB2132	STOP	Black	1	0.062
LPFB2134		Red	5	0.062

- ① Arrow symbol can be used to indicate right or left.
- ② Arrow symbol can be used to indicate up or down.

Pushbutton actuators, spring return, with special symbols

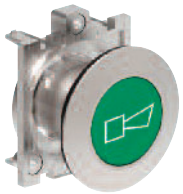

LPFB...

new

Order code	Symbol	Colour	Qty per pkg	Wt
			n°	[kg]
Spring return (without mounting adapter).				
LPFB①②18③	⚡④	⑤	50	0.062
LPFB①②34③	MAN	⑤	50	0.062
LPFB①②35③	AUTO	⑤	50	0.062
LPFB①②22③	↗	⑤	50	0.062
LPFB①②23③	☐	⑤	50	0.062

Note: for other symbols see page 7-35.

- ① Add letter "L" if illuminated type is required.
- ② For the type of actuator, add: 1 for flush or 2 for extended.
- ③ Add the actuator colour: 2 black only for non-illuminated type; 3 green, 4 red, 5 yellow, 6 blue, 8 white or 7 transparent for illuminated version.
- ④ Products available on specific request for a minimum multiple quantity of 50 pieces per type.
- ⑤ Consult Technical support for assistance; see contact details or inside front cover.
- ⑥ Symbol indicating dangerous voltage (IEC 60417 5036-a).

Examples of complete order codes:

LPFB2258 – extended non-illuminated white pushbutton with + symbol
LPFBL1685 – flush illuminated yellow pushbutton actuator with ⚡ symbol.

Operational characteristics

- Any mounting position allowed
- Ambient conditions:
 - Operating temperature: -25...+70°C
 - Storage temperature: -40...+85°C
- Degree of protection:
 - Per IEC/EN: IP66, IP67 and IP69K
 - Per UL: Type 1, 2, 3R, 4, 4X, 12, 12K.

Materials

An aluminium and zinc alloy (zama) is used for the metal part whereas plastic parts are made of polyamide.

Mechanical endurance

Operating force: <0.5kg/1.1lb (actuator).
Mechanical life: 5,000,000 cycles.

Mounting adapter

See page 7-36.

Type: LPXAU120M.

The actuators fit into a Ø30mm/Ø1.18" hole. The fixing of the base to the mounting surface is made using the adapter supplied with the actuator and the screws incorporated in the base (Tmax = 0.7Nm/6.1lb.in).

Contact elements for spring return button actuators

See page 7-37 and 7-38.

Type	Termination
1N0	LPXC10 Screw
	LPXCF10 Faston
	LPXCS10 Spring clamp
1EM	LPXC10A Screw
1NC	LPXC01 Screw
	LPXCF01 Faston
	LPXCS01 Spring clamp
1LB	LPXC01D Screw

All LPFB... actuators are standard supplied with action plug for middle contacts.

Certifications and compliance

Certifications: cULus, EAC, RINA.

Compliant with standards: IEC/EN/BS 60947-1, IEC/EN/BS 60947-5-1, UL508, CSA C22.2 n° 14.

7 Pushbuttons and selector switches

PLatinum series
Ø30mm flat metal



INDEX

Selector switch actuators lever

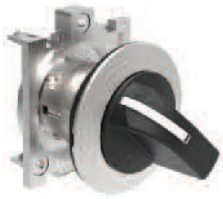

LPFS1...

new

Order code	Type of positions	Qty per pkg	Wt
		n°	[kg]
2 positions (without mounting adapter).			
LPFS120		5	0.062
LPFS121		5	0.062
3 positions (without mounting adapter).			
LPFS130		5	0.062
LPFS131		5	0.062
LPFS132		5	0.062
LPFS133		5	0.062

Selector switch actuators long lever

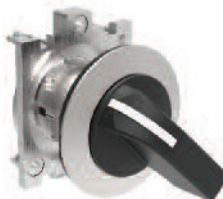

LPFS2...

new

Order code	Type of positions	Qty per pkg	Wt
		n°	[kg]
2 positions (without mounting adapter).			
LPFS220		5	0.065
LPFS221		5	0.065
3 positions (without mounting adapter).			
LPFS230		5	0.065
LPFS231		5	0.065
LPFS232		5	0.065
LPFS233		5	0.065

Selector switch actuators key (Ronis)

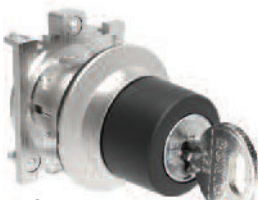

LPFS3...

new

Order code	Type of positions	Qty per pkg	Wt
		n°	[kg]
2 positions (without mounting adapter).			
LPFS320		5	0.095
LPFS320R①		1	0.095
LPFS321		5	0.095
LPFS321R①		1	0.095
LPFS340		5	0.095
LPFS340R①		1	0.095
3 positions (without mounting adapter).			
LPFS330		5	0.095
LPFS330R①		1	0.095
LPFS331		5	0.095
LPFS331R①		1	0.095
LPFS332②		5	0.095
LPFS332R①②		1	0.095
LPFS333②		5	0.095
LPFS333R①②		1	0.095
LPFS350		5	0.095
LPFS350R①		1	0.095
LPFS360		5	0.095
LPFS360R①		1	0.095
LPFS370②		5	0.095
LPFS370R①②		1	0.095
LPFS380②		5	0.095
LPFS380R①②		1	0.095
LPFS390②		5	0.095
LPFS390R①②		1	0.095

① Versions with different key codes. Complete with the numeric code of the key. The following versions are available: 421E, 458A, 520E, 3131A, 3433E. Example of complete code: LPCS320R421E.
② Available only on specific request.

Operational characteristics

- Any mounting position allowed
- Standard key types supplied with Ronis key code n° 455
- Ambient conditions:
 - Operating temperature: -25...+70°C
 - Storage temperature: -40...+85°C
- Degree of protection:
 - Per IEC/EN: IP66, IP67 and IP69K
 - Per UL: Type 1, 2, 3R, 4, 4X, 12, 12K.

Materials

An aluminium and zinc alloy (zama) is used for the metal part whereas plastic parts are made of polyamide.

Mechanical endurance

Mechanical life: 1,000,000 cycles.

Mounting adapter

See page 7-36.

Type: LPXAU120M.

The actuators fit into a Ø30mm/Ø1.18" hole. The fixing of the base to the mounting surface is made using the adapter supplied with the actuator and the screws incorporated in the base (Tmax = 0.7Nm/6.1lb.in).

Contact elements

See page 7-37 and 7-38.

Type	Termination	
1NO	LPXC10	Screw
	LPXCF10	Faston
	LPXCS10	Spring clamp
1EM	LPXC10A	Screw
1NC	LPXC01	Screw
	LPXCF01	Faston
	LPXCS01	Spring clamp
1LB	LPXC01D	Screw

Activation of the middle contacts is coupled to the side contacts; the relative mechanism pins are standard supplied.

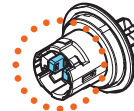

The middle contact activation, with respect to the right and left side contact, can be changed by the user, if required, by removing one mechanism pin. Consult the relative instructions available online in the Downloads section at www.LovatoElectric.com.

Type of position

- Maintained position.
- Spring return position.
- Key extraction position.

Rotation angles



Certifications and compliance

Certifications: cULus, EAC, RINA.
Compliant with standards: IEC/EN/BS 60947-1, IEC/EN/BS 60947-5-1, UL508, CSA C22.2 n° 14.

7 Pushbuttons and selector switches

PLatinum series
Ø30mm flat metal

Selector switch actuators knob



LPFS4...

new

Order code	Type of positions	Qty per pkg	Wt
		n°	[kg]
2 positions (without mounting adapter).			
LPFS420	∇	5	0.072
LPFS421	∇	5	0.072
3 positions (without mounting adapter).			
LPFS430	∇	5	0.072
LPFS431	∇	5	0.072
LPFS432	∇	5	0.072
LPFS433	∇	5	0.072

Contact activation

2-position selector switch

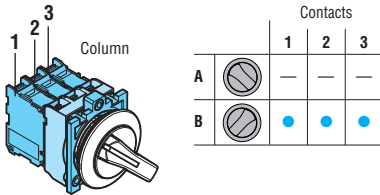

3-position selector switch

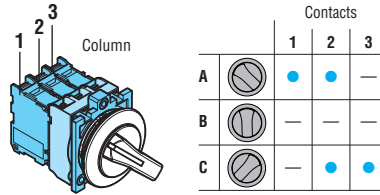

2-position knob selector switch

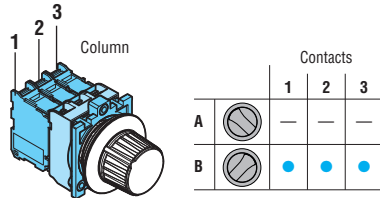

3-position knob selector switch

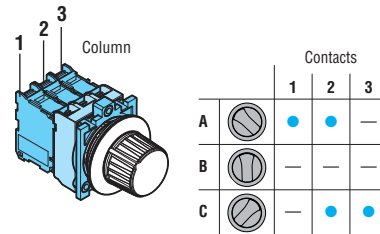

Operational characteristics

- Any mounting position allowed
- Ambient conditions:
 - Operating temperature: -25...+70°C
 - Storage temperature: -40...+85°C
- Degree of protection:
 - Per IEC/EN: IP66, IP67 and IP69K
 - Per UL: Type 1, 2, 3R, 4, 4X, 12, 12K.

Materials

An aluminium and zinc alloy (zama) is used for the metal part whereas plastic parts are made of polyamide.

Mechanical endurance

Mechanical life: 1,000,000 cycles.

Mounting adapter

See page 7-36.

Type: LPXAU120M.

The actuators fit into a Ø30mm/Ø1.18" hole. The fixing of the base to the mounting surface is made using the adapter supplied with the actuator and the screws incorporated in the base (Tmax = 0.7Nm/6.1lb.in).

Contact elements

See page 7-37 and 7-38.

Type	Termination	
1NO	LPXC10	Screw
	LPXCF10	Faston
	LPXCS10	Spring clamp
1EM	LPXC10A	Screw
1NC	LPXC01	Screw
	LPXCF01	Faston
	LPXCS01	Spring clamp
1LB	LPXC01D	Screw

Activation of the middle contacts is coupled to the side contacts; the relative mechanism pins are standard supplied.

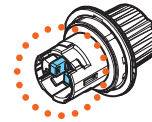

The middle contact activation, with respect to the right and left side contact, can be changed by the user, if required, by removing one mechanism pin. Consult the relative instructions available online in the Downloads section at www.LovatoElectric.com.

Type of position

- ∇ Maintained position.
- ∇ Spring return position.

Rotation angles

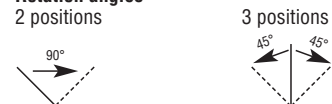

Certifications and compliance

Certifications: cULus, EAC, RINA.

Compliant with standards: IEC/EN/BS 60947-1, IEC/EN/BS 60947-5-1, UL508, CSA C22.2 n° 14.

7 Pushbuttons and selector switches

PLatinum series
Ø30mm flat metal



INDEX

Illuminated button actuators, spring return



LPFBL10...



LPFBL20...

new

Order code	Colour	Qty per pkg	Wt
		n°	[kg]
Flush (without mounting adapter). Spring return.			
LPFBL103	Green	5	0.070
LPFBL104	Red	5	0.070
LPFBL105	Yellow	5	0.070
LPFBL106	Blue	5	0.070
LPFBL107	Transparent	5	0.070
Extended (without mounting adapter). Spring return.			
LPFBL203	Green	5	0.072
LPFBL204	Red	5	0.072
LPFBL205	Yellow	5	0.072
LPFBL206	Blue	5	0.072
LPFBL207	Transparent	5	0.072

Illuminated push-push button actuators



LPFQL10...



LPFQL20...

new

Order code	Colour	Qty per pkg	Wt
		n°	[kg]
Flush (without mounting adapter). Push on-push off.			
LPFQL103⓪	Green	5	0.070
LPFQL104⓪	Red	5	0.070
LPFQL105⓪	Yellow	5	0.070
LPFQL106⓪	Blue	5	0.070
LPFQL107⓪	Transparent	5	0.070
Extended (without mounting adapter). Push on-push off.			
LPFQL203⓪	Green	5	0.072
LPFQL204⓪	Red	5	0.072
LPFQL205⓪	Yellow	5	0.072
LPFQL206⓪	Blue	5	0.072
LPFQL207⓪	Transparent	5	0.072

⓪ Use contact elements LPXC10A (EM) and LPXC01 (NC) only. Contact elements LPXC10 (NO) and LPXC01D (LB) cannot be fitted on these actuators.

Operational characteristics

- Any mounting position allowed
- Ambient conditions:
 - Operating temperature: -25...+70°C
 - Storage temperature: -40...+85°C
- Degree of protection:
 - Per IEC/EN: IP66, IP67 and IP69K
 - Per UL: Type 1, 2, 3R, 4, 4X, 12, 12K.

Materials

An aluminium and zinc alloy (zama) is used for the metal part whereas plastic parts are made of polyamide.

Mechanical endurance

- Operating force: <0.5kg/1.1lb (actuator).
Mechanical life:
- Spring return actuators: 5,000,000 cycles
 - Push-push actuators: 500,000 cycles.

Mounting adapter

See page 7-36.

Type: LPXAU120M.

The actuators fit into a Ø30mm/Ø1.18" hole. The fixing of the base to the mounting surface is made using the adapter supplied with the actuator and the screws incorporated in the base (Tmax = 0.7Nm/6.1lb.in).

Contact elements for illuminated spring return actuators

See page 7-37 and 7-38.

Type	Termination	
1NO	LPXC10	Screw
	LPXCF10	Faston
	LPXCS10	Spring clamp
1EM	LPXC10A	Screw
1NC	LPXC01	Screw
	LPXCF01	Faston
1LB	LPXCS01	Spring clamp
	LPXC01D	Screw

Contact elements for illuminated push-push button actuators

See page 7-37.

Type: LPXC10A (1EM)
LPXC01 (1NC)

Up to 4 contacts can be fitted: 2 each on the left and right, one behind the other.

LED light elements

See pages 7-39 to 42.

Certifications and compliance

Certifications: cULus, EAC, RINA.
Compliant with standards: IEC/EN/BS 60947-1, IEC/EN/BS 60947-5-1, UL508, CSA C22.2 n° 14.

7 Pushbuttons and selector switches

PLatinum series
Ø30mm flat metal

Illuminated selector switch actuators



LPFSL1...

new

Contact activation of 2-position selector switch

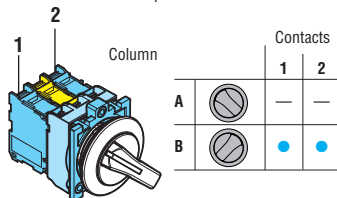

Contact activation of 3-position selector switch

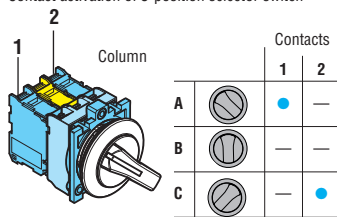

Order code	Colour	Type of positions	Qty per pkg n°	Wt [kg]
2 positions (without mounting adapter).				
LPFSL1203	Green	∇	5	0.060
LPFSL1204	Red		5	0.060
LPFSL1205	Yellow		5	0.060
LPFSL1206	Blue		5	0.060
LPFSL1208	White		5	0.060
LPFSL1213	Green	∇	5	0.060
LPFSL1214	Red		1	0.060
LPFSL1215	Yellow		1	0.060
LPFSL1216	Blue		1	0.060
LPFSL1218	White		5	0.060
3 positions (without mounting adapter).				
LPFSL1303	Green	∇	5	0.060
LPFSL1304	Red		5	0.060
LPFSL1305	Yellow		5	0.060
LPFSL1306	Blue		5	0.060
LPFSL1308	White		5	0.060
LPFSL1313	Green	∇	5	0.060
LPFSL1314	Red		1	0.060
LPFSL1315	Yellow		1	0.060
LPFSL1316	Blue		1	0.060
LPFSL1318	White		5	0.060
LPFSL1323	Green	∇	5	0.060
LPFSL1324	Red		1	0.060
LPFSL1325	Yellow		1	0.060
LPFSL1326	Blue		1	0.060
LPFSL1328	White		5	0.060
LPFSL1333	Green	∇	5	0.060
LPFSL1334	Red		1	0.060
LPFSL1335	Yellow		1	0.060
LPFSL1336	Blue		1	0.060
LPFSL1338	White		5	0.060

Operational characteristics

- Any mounting position allowed
- Ambient conditions:
 - Operating temperature: -25...+70°C
 - Storage temperature: -40...+85°C
- Degree of protection:
 - Per IEC/EN: IP66, IP67 and IP69K
 - Per UL: Type 1, 2, 3R, 4, 4X, 12, 12K.

Materials

An aluminium and zinc alloy (zama) is used for the metal part whereas plastic parts are made of polyamide.

Mechanical endurance

- Operating force: <0.5kg/1.1lb (actuator).
Mechanical life:
– Selector switches: 1,000,000 cycles.

Mounting adapter

See page 7-36.

Type: LPXAU120M.

The actuators fit into a Ø30mm/Ø1.18" hole. The fixing of the base to the mounting surface is made using the adapter supplied with the actuator and the screws incorporated in the base (Tmax = 0.7Nm/6.1lb.in).

Contact elements

See page 7-37 and 7-38.

Type	Termination	
1NO	LPXC10	Screw
	LPXCF10	Faston
	LPXCS10	Spring clamp
1EM	LPXC10A	Screw
1NC	LPXC01	Screw
	LPXCF01	Faston
	LPXCS01	Spring clamp
1LB	LPXC01D	Screw

Selector switch type of positions

- ∇ Maintained position.
- ∇ Spring return position.

Selector switch rotation angles

2 positions



3 positions



LED light elements

See pages 7-39 to 42.

Certifications and compliance

Certifications: cULus, EAC, RINA.
Compliant with standards: IEC/EN/BS 60947-1, IEC/EN/BS 60947-5-1, UL508, CSA C22.2 n° 14.

7 Pushbuttons and selector switches

PLatinum series
Ø30mm flat metal

Pilot light heads



LPFL...

new

Order code	Colour	Qty per pkg	Wt
		n°	[kg]
Without mounting adapter.			
LPFL3	Green	5	0.054
LPFL4	Red	5	0.054
LPFL5	Yellow	5	0.054
LPFL6	Blue	5	0.054
LPFL7	Transparent	5	0.054
LPFL1187	Transparent ⚡ ⚠	5	0.054

⚠ With symbol indicating dangerous voltage (IEC/EN/BS 60417 5036-a).

Operational characteristics

- Any mounting position allowed
- Ambient conditions:
 - Operating temperature: -25...+70°C
 - Storage temperature: -40...+85°C
- Degree of protection:
 - Per IEC/EN: IP66, IP67 and IP69K
 - Per UL: Type 1, 2, 3R, 4, 4X, 12, 12K.

Materials

An aluminium and zinc alloy (zama) is used for the metal part whereas plastic parts are made of polyamide.

Mounting adapter

See page 7-36.

Type: LPXAU120M.

The actuators fit into a Ø30mm/Ø1.18" hole. The fixing of the base to the mounting surface is made using the adapter supplied with the actuator and the screws incorporated in the base (Tmax = 0.7Nm/6.1lb.in).

LED light elements

See pages 7-39 to 42.

Certifications and compliance

Certifications: cULus, EAC, RINA.

Compliant with standards: IEC/EN/BS 60947-1, IEC/EN/BS 60947-5-1, UL508, CSA C22.2 n° 14.

USB and RJ45 communication interfaces



LPFD01



LPFD01L...



LPFD06

new

Order code	Description	Qty	Wt
		per pkg	
		n°	[kg]
LPFD01	USB interface, A/A female type connection	1	0.053
LPFD01L050	USB interface, A/A female connection with 0.5m long cable	1	0.095
LPFD01L100	USB interface, A/A female connection with 1m long cable	1	0.115
LPFD03	USB interface, A/B female type connection	1	0.053
LPFD05	USB interface, B/A female type connection	1	0.053
LPFD06	RJ45 interface,, Ethernet connection type	1	0.061
LPFD06L100	RJ45 interface, Ethernet connection with 1m long cable	1	0.125

General characteristics

USB and RJ45 communication interface connectors are used in industrial environments, which in recent years have seen an increase in the number of connections between machines, production lines, equipment and measuring instruments. These interfaces provide the transmission of data in both directions between the various devices.

Operational characteristics

- Rated insulation voltage for LPFD01, LPFD03, LPFD05: 5VAC/DC
- Rated insulation voltage for LPFD06: 50VAC/DC
- Installed through a Ø30mm/Ø1.18" drilling with a threaded fixing ring (Tmax = 0.8Nm/7lb.in)
- Transmission characteristics for LPFD01, LPFD03, LPFD05: 5Gbps (625MB/sec)
- Transmission characteristics for LPFD06: Cat.6
- Rated current for LPFD01, LPFD03, LPFD05: 1.5A
- Rated current for LPFD06: 0.6A
- Insulation resistance: ≥100MΩ
- Contact resistance for LPFD01, LPFD03, LPFD05: ≤30mΩ
- Contact resistance for LPFD06: ≤40mΩ
- USB connector class: 3.0 (backward compatible with USB class 2.0)
- Ambient conditions:
 - Operating temperature: -25...+70°C
 - Storage temperature: -40...+85°C
- Degree of protection:
 - Per IEC/EN: IP65 on front (with cap mounted)
 - Per IEC/EN: IP20 at rear
 - Per UL: Type 1, 2, 3R, 4, 4X, 12, 12K on front (with cap mounted).

Materials

An aluminium and zinc alloy (zama) is used for the metal part whereas plastic parts are made of polyamide.

Certifications and compliance

Certifications: cULus, EAC, RINA.
Compliant with standards: IEC/EN/BS 60947-1, IEC/EN/BS 60947-5-1, UL508, CSA C22.2 n° 14.

7 Pushbuttons and selector switches

PLatinum series
Ø22mm chromed plastic



INDEX

Pushbutton actuators, spring return



LPCB10...



LPCB20...



LPCB30...

Push-push button actuators



LPCQ10...



LPCQ20...

Order code	Colour	Qty per pkg n°	Wt [kg]
Flush (without mounting adapter). Spring return.			
LPCB102	Black	10	0.025
LPCB103	Green	10	0.025
LPCB104	Red	10	0.025
LPCB105	Yellow	10	0.025
LPCB106	Blue	10	0.025
LPCB108	White	10	0.025
Extended (without mounting adapter). Spring return.			
LPCB202	Black	10	0.027
LPCB203	Green	10	0.027
LPCB204	Red	10	0.027
LPCB205	Yellow	1	0.027
LPCB206	Blue	1	0.027
LPCB208	White	1	0.027
Shrouded (without mounting adapter). Spring return.			
LPCB302	Black	10	0.027
LPCB303	Green	10	0.027
LPCB304	Red	10	0.027
LPCB305	Yellow	1	0.027
LPCB306	Blue	1	0.027
LPCB308	White	1	0.027

Order code	Colour	Qty per pkg n°	Wt [kg]
Flush (without mounting adapter). Push on-push off.			
LPCQ102❶	Black	10	0.025
LPCQ103❶	Green	10	0.025
LPCQ104❶	Red	10	0.025
LPCQ105❶	Yellow	1	0.025
LPCQ106❶	Blue	1	0.025
LPCQ108❶	White	1	0.025
Extended (without mounting adapter). Push on-push off.			
LPCQ202❶	Black	10	0.027
LPCQ203❶	Green	10	0.027
LPCQ204❶	Red	10	0.027
LPCQ205❶	Yellow	1	0.027
LPCQ206❶	Blue	1	0.027
LPCQ208❶	White	1	0.027

❶ Use contact elements LPXC10A (EM) and LPXC01 (NC) only.
Contact elements LPXC10 (NO) and LPXC01D (LB) cannot be fitted on these actuators.
For the number of contacts that can be fitted, see the indication here to the side.

Operational characteristics

- Any mounting position allowed
- Ambient conditions:
 - Operating temperature: -25...+70°C
 - Storage temperature: -40...+85°C
- Degree of protection:
 - Per IEC/EN: IP66, IP67 and IP69K
 - Per UL: Type 1, 2, 3R, 4, 4X, 12, 12K.

Materials

Polyamide.

Mechanical endurance

- Operating force: <0.5kg/1.1lb (actuator).
Mechanical life:
- Spring return actuators: 5,000,000 cycles
 - Push-push actuators: 500,000 cycles.

Mounting adapter

See page 7-36.

Type: LPXAU120.

Actuators are installed through a Ø22mm/Ø0.87" drilling with a threaded fixing ring (Tmax = 2.3Nm/20.3lb.in) also on the cover of LPZ... control stations.

The mounting adapter directly snaps onto the actuator.

Contact elements for spring return button actuators

See page 7-37 and 7-38.

Type	Termination
1NO	LPXC10 LPXCF10 LPXCS10
1EM	LPXC10A
1NC	LPXC01 LPXCF01 LPXCS01
1LB	LPXC01D

Front-mount types snap onto LPXAU120 mounting adapter (to purchase separately).
Up to 9 contacts can be fitted: 3 each on the left, middle and right, one behind the other.
The LPXAU120 mounting adapter can also be fitted internally to the cover of the LPZ... control station with up to 3 elements per actuator.

1NO	LPXC10	Screw
	LPXCF10	Faston
	LPXCS10	Spring clamp
1EM	LPXC10A	Screw
1NC	LPXC01	Screw
	LPXCF01	Faston
	LPXCS01	Spring clamp
1LB	LPXC01D	Screw

Base mount types snap into LPZP... control station base.
See example on page 7-38.

Up to 3 contacts can be fitted per LPZ... control station actuator.

1NO	LPXCB10	Screw
1NC	LPXCB01	Screw

Contact elements for push-push button actuators

See page 7-37.

Type: LPXC10A (1EM)
LPXC01 (1NC)

Contacts snap onto the adapter also internally on the cover surface of LPZ... control stations.

Up to 6 contacts can be fitted: 2 each on the left, middle and right, one behind of the other; up to 3 elements per control station actuator.

All these actuators are standard supplied with action plug for middle contacts.

Certifications and compliance

Certifications obtained: UL Listed for USA and Canada, (cULus - File E93601), as Auxiliary Devices; EAC, CCC, RINA. Compliant with standards: IEC/EN/BS 60947-1, IEC/EN/BS 60947-5-1, UL508, CSA C22.2 n° 14.

7 Pushbuttons and selector switches

PLatinum series
Ø22mm chromed plastic

Mechanical rest buttons, complete unit, spring return



LPCR1196

Order code	Colour	Qty per pkg	Wt
		n°	[kg]
Flush (5.2mm/0.2" stroke). Adjustable length 0-150mm/5.9". Complete with shaft (without mounting adapter). Spring return.			
LPCR1002	Black	10	0.038
LPCR1003	Green	10	0.038
LPCR1004	Red	10	0.038
LPCR1006	Blue	10	0.038
LPCR1196	Blue (RESET)	10	0.038
Extended (5.2mm/0.2" stroke). Adjustable length 0-150mm/5.9". Complete with shaft (without mounting adapter). Spring return.			
LPCR2004	Red	1	0.040

① With "RESET" caption on actuator.
E.g. Not suitable for LPZ... control stations.

Pushbutton actuators, spring return, with symbol



LPCB11...



LPCB21...

Order code	Symbol	Colour	Qty per pkg	Wt
			n°	[kg]
Flush (without mounting adapter). Spring return.				
LPCB1102	0	Black	10	0.025
LPCB1104		Red	10	0.025
LPCB1113	I	Green	10	0.025
LPCB1118		White	10	0.025
LPCB1123	II	Green	1	0.025
LPCB1128		White	1	0.025
LPCB1132	STOP	Black	1	0.025
LPCB1134		Red	10	0.025
LPCB1142	←	Black	10	0.025
LPCB1148	←	White	10	0.025
LPCB1152	↑	Black	10	0.025
LPCB1158	↑	White	10	0.025
LPCB1163	START	Green	10	0.025
LPCB1168		White	1	0.025
LPCB1176	R	Blue	1	0.025
LPCB1178		White	1	0.025
LPCB1196	RESET	Blue	10	0.025
LPCB1502	⚡	Black	10	0.025
LPCB1512	↔	Black	10	0.025
Extended (without mounting adapter). Spring return.				
LPCB2102	0	Black	10	0.027
LPCB2104		Red	10	0.027
LPCB2132	STOP	Black	1	0.027
LPCB2134		Red	10	0.027

① Arrow symbol can be used to indicate right or left.
② Arrow symbol can be used to indicate up or down.

Pushbutton actuators, spring return, with special symbols



LPCB...

Order code	Symbol	Colour	Qty per pkg	Wt
			n°	[kg]
Spring return (without mounting adapter).				
LPCB①②18③	⚡	③	50	0.027
LPCB①②34③	MAN	③	50	0.027
LPCB①②35③	AUTO	③	50	0.027
LPCB①②22③	↗	③	50	0.027
LPCB①②23③	⏏	③	50	0.027

Note: for other symbols see page 7-35.

- ① Add letter "L" if illuminated type is required.
 - ② For the type of actuator, add: 1 for flush or 2 for extended.
 - ③ Add the actuator colour: 2 black only for non-illuminated type; 3 green, 4 red, 5 yellow, 6 blue, 8 white or 7 transparent for illuminated version.
 - ④ Products available on specific request for a minimum multiple quantity of 50 pieces per type.
 - ⑤ Consult Technical support for assistance; see contact details or inside front cover.
 - ⑥ Symbol indicating dangerous voltage (IEC 60417 5036-a).
- Examples of complete order codes:
LPCB2258 – extended non-illuminated white pushbutton with ⚡ symbol
LPCB1685 – flush illuminated yellow pushbutton actuator with ⚡ symbol.

Operational characteristics

- Any mounting position allowed
- Fine rod adjustment (1-4mm/0.04-0.16") on front with screwdriver by removing actuator cap for mechanical reset buttons
- Ambient conditions:
 - Operating temperature: -25...+70°C
 - Storage temperature: -40...+85°C
- Degree of protection:
 - Per IEC/EN: IP66, IP67 and IP69K
 - Per UL: Type 1, 2, 3R, 4, 4X, 12, 12K.

Materials

Polyamide.

Mechanical endurance

Operating force: <0.5kg/1.1lb (actuator).
Mechanical life: 5,000,000 cycles.

Mounting adapter

See page 7-36.

Type: LPXAU120.

Actuators are installed through a Ø22mm/Ø0.87" drilling with a threaded fixing ring (Tmax = 2.3Nm/20.3lb.in) also on the cover of LPZ... control stations.

The mounting adapter directly snaps onto the actuator.

Contact elements for mechanical reset buttons

See page 7-37 and 7-38.

Type | Termination

Front mount types snap onto LPXAU120 mounting adapter (to purchase separately), if any contacts are needed. Up to 6 contacts can be fitted: 3 each on the left and right, one behind the other.

1NO	LPXC10	Screw
	LPXCF10	Faston
	LPXCS10	Spring clamp
1EM	LPXC10A	Screw
1NC	LPXC01	Screw
	LPXCF01	Faston
	LPXCS01	Spring clamp
1LB	LPXC01D	Screw

Contact elements for spring return button actuators

See page 7-37 and 7-38.

Type | Termination

Front-mount types snap onto LPXAU120 mounting adapter (to purchase separately). Up to 9 contacts can be fitted: 3 each on the left, middle and right; one behind the other. The LPXAU120 mounting adapter can also be fitted internally to the cover of the LPZ... control station with up to 3 elements per actuator.

1NO	LPXC10	Screw
	LPXCF10	Faston
	LPXCS10	Spring clamp
1EM	LPXC10A	Screw
1NC	LPXC01	Screw
	LPXCF01	Faston
	LPXCS01	Spring clamp
1LB	LPXC01D	Screw

Base mount types snap into LPZP... control station base. See example on page 7-38.

Up to 3 contacts can be fitted per LPZ... control station actuator.

1NO	LPXCB10	Screw
1NC	LPXCB01	Screw

The LPCB... actuators are standard supplied with action plug for middle contacts.

Certifications and compliance

Certifications obtained: UL Listed for USA and Canada, (cULus - File E93601), as Auxiliary Devices; EAC, CCC, RINA. Compliant with standards: IEC/EN/BS 60947-1, IEC/EN/BS 60947-5-1, UL508, CSA C22.2 n° 14.

7 Pushbuttons and selector switches

PLatinum series
Ø22mm chromed plastic



INDEX

Mushroom head pushbutton actuators



LPCB614...



LPCB674...



LPCB6344



LPCB6634



LPCB6644



LPCB684...

Order code	Colour	Qty per pkg	Wt
		n°	[kg]

SPRING RETURN.
Ø40mm/1.57" (without mounting adapter).

LPCB6142	Black	10	0.033
LPCB6143	Green	10	0.033
LPCB6144	Red	10	0.033
LPCB6145	Yellow	10	0.033
LPCB6146	Blue	10	0.033

Ø60mm/2.36" (without mounting adapter).

LPCB6162	Black	10	0.038
LPCB6163	Green	1	0.038
LPCB6164	Red	10	0.038
LPCB6165	Yellow	1	0.038
LPCB6166	Blue	1	0.038

LATCH, PULL TO RELEASE.
Ø40mm/1.57" (without mounting adapter).
For normal stopping.

LPCB6742	Black	10	0.097
LPCB6744	Red	10	0.097

For emergency stopping, ISO 13850 compliant.

LPCB6342	Black	10	0.046
LPCB6344	Red	10	0.046

LATCH, TURN TO RELEASE.
Ø40mm/1.57" (without mounting adapter).
For normal stopping.

LPCB6342	Black	10	0.046
LPCB6344	Red	10	0.046

Ø30mm/1.18" (without mounting adapter).
For emergency stopping, ISO 13850 compliant.

LPCB6634	Red	10	0.079
----------	-----	----	-------

Ø40mm/1.57" (without mounting adapter).
For emergency stopping, ISO 13850 compliant.

LPCB6644	Red	10	0.079
----------	-----	----	-------

LATCH, TURN KEY TO RELEASE.
Ø40mm/1.57" (without mounting adapter). Key code n° 455.
For normal stopping.

LPCB6842	Black	10	0.083
LPCB6842R	Black	1	0.083

For emergency stopping, ISO 13850 compliant.

LPCB6844	Red	10	0.083
LPCB6844R	Red	1	0.083

① Versions with different key codes.
Complete with the numeric code of the key.
The following versions are available: 421E, 458A, 520E, 3131A, 3433E.
Example of complete code: LPCB6844R421E.

Normal operation of auto-monitor contact mounted on surface or on cover of control stations

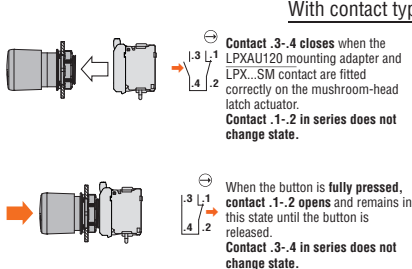

In case of detachment of only the contact element and/or of the mounting adapter with contact element

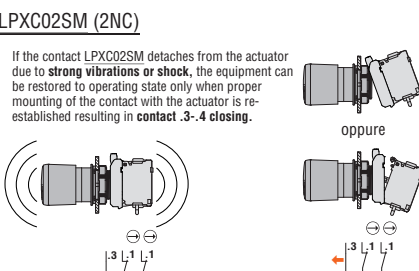
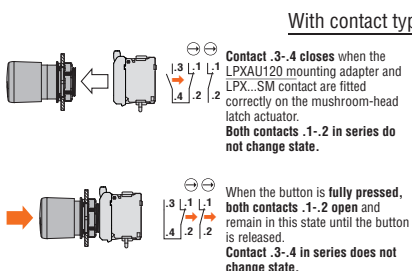
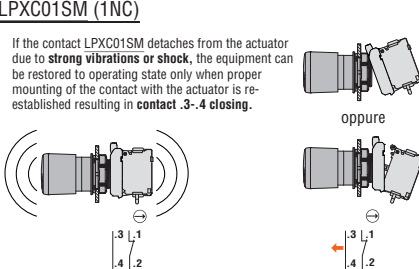

Operational characteristics

- Any mounting position allowed
- Ambient conditions:
 - Operating temperature: -25...+70°C
 - Storage temperature: -40...+85°C
- Degree of protection:
 - Per IEC/EN: IP66, IP67 and IP69K
 - Per UL: Type 1, 2, 3R, 4, 4X, 12, 12K.

Materials

Polyamide.

Mechanical endurance

- Operating force: <0.5kg/1.1lb (actuator).
Mechanical life:
- Spring return mushroom-head actuators: 5,000,000 cycles
 - Latch mushroom-head actuators: 300,000 cycles.

Mounting adapter

See page 7-36.
Type: LPXAU120.
Actuators are installed through a Ø22mm/Ø0.87" drilling with a threaded fixing ring (Tmax = 2.3Nm/20.3lb.in) also on the cover of LPZ... control stations.
The mounting adapter directly snaps onto the actuator.

Contact elements

See page 7-37 and 7-38.

Type	Termination
1NO	LPXC10 Screw LPXCF10 Faston LPXCS10 Spring clamp
1EM	LPXC10A Screw
1NC	LPXC01 Screw LPXCF01 Faston LPXCS01 Spring clamp
1LB	LPXC01D Screw

Base mount types snap into LPZP... control station base.
See example on page 7-38.

Up to 3 contacts can be fitted per LPZ... control station actuator.

1NO	LPXCB10	Screw
1NC	LPXCB01	Screw

AUTO-MONITOR CONTACT with MUSHROOM-HEAD LATCH TYPES only: 2 elements max of this type can be mounted. Extra two contacts can be fitted on the right.
Two elements per actuator can be fixed internally on the cover surface of LPZ... control stations of which one auto-monitor type. No LED element can be installed.

Auto-monitor 1NO	LPXC01SM	Screw (2 stacked in the middle - LPXAU120 pos.1/3-4/6)
1NO	LPXC10	Screw (2 stacked on the right)
	LPXCF10	Faston (2 stacked on the right)
	LPXCS10	Spring clamp (2 stacked on the right)
1NC	LPXC01	Screw (2 stacked on the right)
	LPXCF01	Faston (2 stacked on the right)
	LPXCS01	Spring clamp (2 stacked on the right)
Auto-monitor 2NC	LPXC02SM	Screw (2 stacked)

All these actuators are standard-supplied with action plug for middle contacts.

Certifications and compliance

Certifications obtained: UL Listed for USA and Canada, (cULus - File E93601), as Auxiliary Devices; EAC, CCC, RINA. Compliant with standards: IEC/EN/BS 60947-1, IEC/EN/BS 60947-5-1, UL508, CSA C22.2 n° 14.

7 Pushbuttons and selector switches

PLatinum series
Ø22mm chromed plastic

Double-touch actuators, spring return



LPCB71...



LPCB72...

new

Order code	Colour	Symbols	Qty per pkg n°	Wt [kg]
------------	--------	---------	-------------------	------------

Two flush pushbuttons (without mounting adapter). Both spring return.

LPCB7112	Black/Red	—	5	0.030
LPCB7113	Green/Red	—	5	0.030
LPCB7114	White/Black	—	5	0.030
LPCB7122	Black/Red	I-O	5	0.030
LPCB7123	Green/Red	I-O	5	0.030
LPCB7124	White/Black	I-O	5	0.030
LPCB7133	Green/Red	Start/Stop	5	0.030
LPCB7191	Black/Black	↑ ↓	5	0.030

One extended and one flush pushbuttons (without mounting adapter). Both spring return.

LPCB7212	Black/Red	—	1	0.030
LPCB7213	Green/Red	—	5	0.030
LPCB7214	White/Black	—	1	0.030
LPCB7222	Black/Red	I-O	5	0.030
LPCB7223	Green/Red	I-O	5	0.030
LPCB7224	White/Black	I-O	1	0.030
LPCB7233	Green/Red	Start/Stop	5	0.030

Triple-touch actuators, spring return



LPCB73...

Order code	Symbols	Qty per pkg n°	Wt [kg]
------------	---------	-------------------	------------

One middle extended buttons (without mounting adapter). Spring return.

LPCB7345	↑ STOP ↓	5	0.030
LPCB7355	↑ STOP ↓	5	0.030
LPCB7365	→ STOP ←	5	0.030
LPCB7375	↗ STOP ↙	5	0.030

Operational characteristics

- Any mounting position allowed
- Ambient conditions:
 - Operating temperature: -25...+70°C
 - Storage temperature: -40...+85°C
- Degree of protection:
 - Per IEC/EN: IP66, IP67 and IP69K
 - Per UL: Type 1, 2, 3R, 4, 4X, 12, 12K.

Materials

Polyamide.

Mechanical endurance

Operating force: <0.5kg/1.1lb (actuator).
Mechanical life: 1,000,000 cycles.

Mounting adapter

See page 7-36.

Type: LPXAU120.

Actuators are installed through a Ø22mm/Ø0.87" drilling with a threaded fixing ring (Tmax = 2.3Nm/20.3lb.in) also on the cover of LPZ... control stations.

The mounting adapter directly snaps onto the actuator.

Contact elements

See page 7-37 and 7-38.

Type	Termination
------	-------------

Front-mount types snap onto LPXAU120 mounting adapter (to purchase separately).

For DOUBLE-TOUCH actuators, up to 6 contacts can be fitted: 3 on the left, 3 on the right.

For TRIPLE-TOUCH actuators, up to 9 contacts can be fitted: 3 each on the left, middle and right, one behind the other.

The LPXAU120 mounting adapter can also be fitted internally to the cover of the LPZ... control station with up to 2 elements for double-touch and 3 elements for triple-touch actuators.

1NO	LPXC10	Screw
	LPXCF10	Faston
	LPXCS10	Spring clamp
1EM	LPXC10A	Screw
1NC	LPXC01	Screw
	LPXCF01	Faston
	LPXCS01	Spring clamp
1LB	LPXC01D	Screw

Base mount types snap into LPZP... control station base. See example on page 7-38.

For DOUBLE-TOUCH actuators, 2 contacts need to be fitted, one on the left and one on the right.

For TRIPLE-TOUCH actuators, 3 contacts need to be fitted: one each on the left, middle and right.

1NO	LPXCB10	Screw
1NC	LPXCB01	Screw

Certifications and compliance

Certifications obtained: UL Listed for USA and Canada, (cULus - File E93601), as Auxiliary Devices; EAC, CCC, RINA. Compliant with standards: IEC/EN/BS 60947-1, IEC/EN/BS 60947-5-1, UL508, CSA C22.2 n° 14.

7 Pushbuttons and selector switches

PLatinum series
Ø22mm chromed plastic



INDEX

Selector switch actuators lever



LPCS1...

Order code	Type of positions	Qty per pkg	Wt
		n°	[kg]
2 positions (without mounting adapter).			
LPCS120		10	0.037
LPCS121		10	0.037
3 positions (without mounting adapter).			
LPCS130		10	0.037
LPCS131		10	0.037
LPCS132		10	0.037
LPCS133		10	0.037

Selector switch actuators long lever



LPCS2...

Order code	Type of positions	Qty per pkg	Wt
		n°	[kg]
2 positions (without mounting adapter).			
LPCS220		10	0.040
LPCS221		10	0.040
3 positions (without mounting adapter).			
LPCS230		10	0.040
LPCS231		10	0.040
LPCS232		10	0.040
LPCS233		10	0.040

Selector switch actuators key (Ronis)



LPCS3...

Order code	Type of positions	Qty per pkg	Wt
		n°	[kg]
2 positions (without mounting adapter).			
LPCS320		10	0.060
LPCS320R [ⓐ]		1	0.060
LPCS321		10	0.060
LPCS321R [ⓐ]		1	0.060
LPCS340		10	0.060
LPCS340R [ⓐ]		1	0.060
3 positions (without mounting adapter).			
LPCS330		10	0.060
LPCS330R [ⓐ]		1	0.060
LPCS331		10	0.060
LPCS331R [ⓐ]		1	0.060
LPCS332 [ⓐ]		10	0.060
LPCS332R ^{ⓐⓑ}		1	0.060
LPCS333 [ⓐ]		10	0.060
LPCS333R ^{ⓐⓑ}		1	0.060
LPCS350		10	0.060
LPCS350R [ⓐ]		1	0.060
LPCS360		10	0.060
LPCS360R [ⓐ]		1	0.060
LPCS370 [ⓐ]		10	0.060
LPCS370R ^{ⓐⓑ}		1	0.060
LPCS380 [ⓐ]		10	0.060
LPCS380R ^{ⓐⓑ}		1	0.060
LPCS390 [ⓐ]		10	0.060
LPCS390R ^{ⓐⓑ}		1	0.060

ⓐ Versions with different key codes. Complete with the numeric code of the key. The following versions are available: 421E, 458A, 520E, 3131A, 3433E. Example of complete code: LPC S320 R421E.
 ⓑ Available only on specific request.

Operational characteristics

- Any mounting position allowed
- Standard key types supplied with Ronis key code n° 455
- Ambient conditions:
 - Operating temperature: -25...+70°C
 - Storage temperature: -40...+85°C
- Degree of protection:
 - Per IEC/EN: IP66, IP67 and IP69K
 - Per UL: Type 1, 2, 3R, 4, 4X, 12, 12K.

Materials

Polyamide.

Mechanical endurance

Mechanical life: 1,000,000 cycles.

Mounting adapter

See page 7-36.

Type: LPXAU120.

Actuators are installed through a Ø22mm/Ø0.87" drilling with a threaded fixing ring (Tmax = 2.3Nm/20.3lb.in) also on the cover of LPZ... control stations.

The mounting adapter directly snaps onto the actuator.

Contact elements

See page 7-37 and 7-38.

Type	Termination
1NO	LPXC10 Screw
	LPXCF10 Faston
	LPXCS10 Spring clamp
1EM	LPXC10A Screw
1NC	LPXC01 Screw
	LPXCF01 Faston
	LPXCS01 Spring clamp
1LB	LPXC01D Screw

Front-mount types snap onto LPXAU120 mounting adapter (to purchase separately). Up to 6 contacts can be fitted: 2 each on the left, middle and right or 3 each on the left and right, one behind the other.
 The LPXAU120 mounting adapter can also be fitted internally to the cover of the LPZ... control station with up to 3 elements per actuator

1NO	LPXC10	Screw
	LPXCF10	Faston
	LPXCS10	Spring clamp
1EM	LPXC10A	Screw
1NC	LPXC01	Screw
	LPXCF01	Faston
	LPXCS01	Spring clamp
1LB	LPXC01D	Screw

Base mount types snap into LPZP... control station base. See example on page 7-38.

Up to 3 contacts can be fitted per LPZ... control station actuator.

1NO	LPXCB10	Screw
1NC	LPXCB01	Screw

Activation of the middle contacts is coupled to the side contacts; the relative mechanism pins are standard supplied.



The middle contact activation, with respect to the right and left side contact, can be changed by the user, if required, by removing one or both mechanism pins. Consult the relative instructions available online in the Downloads section at www.LovatoElectric.com.

Type of position

- Maintained position.
- Spring return position.
- Key extraction position.

Rotation angles

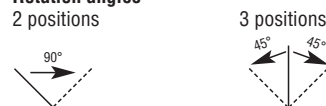

Certifications and compliance

Certifications obtained: UL Listed for USA and Canada, (cULus - File E93601), as Auxiliary Devices; EAC, CCC, RINA. Compliant with standards: IEC/EN/BS 60947-1, IEC/EN/BS 60947-5-1, UL508, CSA C22.2 n° 14.

7 Pushbuttons and selector switches

PLatinum series
Ø22mm chromed plastic

Selector switch actuators knob



LPCS4...

Order code	Type of positions	Qty per pkg	Wt
		n°	[kg]
2 positions (without mounting adapter).			
LPCS420	∇	10	0.037
LPCS421	∇	10	0.037
3 positions (without mounting adapter).			
LPCS430	∇	10	0.037
LPCS431	∇	10	0.037
LPCS432	∇	10	0.037
LPCS433	∇	10	0.037

Contact activation

2-position selector switch

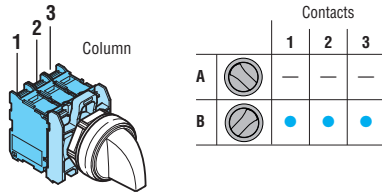

3-position selector switch

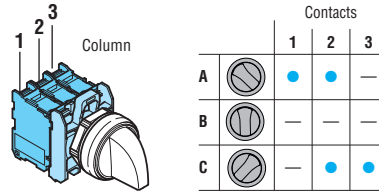

2-position knob selector switch

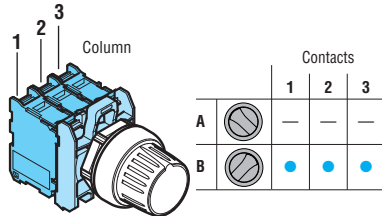

3-position knob selector switch

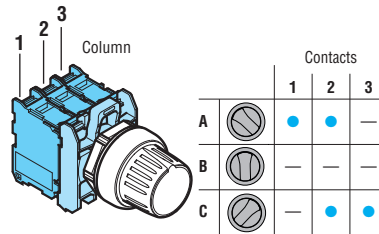

Operational characteristics

- Any mounting position allowed
- Ambient conditions:
 - Operating temperature: -25...+70°C
 - Storage temperature: -40...+85°C
- Degree of protection:
 - Per IEC/EN: IP66, IP67 and IP69K
 - Per UL: Type 1, 2, 3R, 4, 4X, 12, 12K.

Materials

Polyamide.

Mechanical endurance

Mechanical life: 1,000,000 cycles.

Mounting adapter

See page 7-36.

Type: LPXAU120.

Actuators are installed through a Ø22mm/Ø0.87" drilling with a threaded fixing ring (Tmax = 2.3Nm/20.3lb.in) also on the cover of LPZ... control stations.

The mounting adapter directly snaps onto the actuator.

Contact elements

See page 7-37 and 7-38.

Type	Termination
Front-mount types snap onto LPXAU120 mounting adapter (to purchase separately). Up to 6 contacts can be fitted: 2 each on the left, middle and right or 3 each on the left and right, one behind the other.	
The LPXAU120 mounting adapter can also be fitted internally to the cover of the LPZ... control station with up to 3 elements per actuator.	

1NO	LPXC10	Screw
	LPXCF10	Faston
	LPXCS10	Spring clamp
1EM	LPXC10A	Screw
1NC	LPXC01	Screw
	LPXCF01	Faston
	LPXCS01	Spring clamp
1LB	LPXC01D	Screw

Base mount types snap into LPZP... control station base.

See example on page 7-38.

Up to 3 contacts can be fitted per LPZ... control station actuator.

1NO	LPXCB10	Screw
1NC	LPXCB01	Screw

Activation of the middle contacts is coupled to the side contacts; the relative mechanism pins are standard supplied.

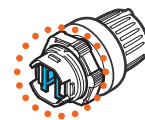

The middle contact activation, with respect to the right and left side contact, can be changed by the user, if required, by removing one or both mechanism pins. Consult the relative instructions available online in the Downloads section at www.LovatoElectric.com.

Type of position

- ∇ Maintained position.
- ∇ Spring return position.

Rotation angles

2 positions



3 positions



Certifications and compliance

Certifications: UL Listed for USA and Canada, (cULus - File E93601), as Auxiliary Devices; EAC, CCC, RINA.
Compliant with standards: IEC/EN/BS 60947-1, IEC/EN/BS 60947-5-1, UL508, CSA C22.2 n° 14.

7 Pushbuttons and selector switches

PLatinum series
Ø22mm chromed plastic



INDEX

Illuminated button actuators, spring return



LPCBL10...



LPCBL20...

Order code	Colour	Qty per pkg	Wt
		n°	[kg]
Flush (without mounting adapter). Spring return.			
LPCBL103	Green	10	0.025
LPCBL104	Red	10	0.025
LPCBL105	Yellow	10	0.025
LPCBL106	Blue	10	0.025
LPCBL107	Transparent	10	0.025
Extended (without mounting adapter). Spring return.			
LPCBL203	Green	10	0.027
LPCBL204	Red	10	0.027
LPCBL205	Yellow	10	0.027
LPCBL206	Blue	10	0.027
LPCBL207	Transparent	10	0.027

Illuminated push-push button actuators



LPCQL10...



LPCQL20...

Order code	Colour	Qty per pkg	Wt
		n°	[kg]
Flush (without mounting adapter). Push on-push off.			
LPCQL103⓪	Green	10	0.025
LPCQL104⓪	Red	10	0.025
LPCQL105⓪	Yellow	10	0.025
LPCQL106⓪	Blue	10	0.025
LPCQL107⓪	Transparent	10	0.025
Extended (without mounting adapter). Push on-push off.			
LPCQL203⓪	Green	10	0.027
LPCQL204⓪	Red	10	0.027
LPCQL205⓪	Yellow	10	0.027
LPCQL206⓪	Blue	10	0.027
LPCQL207⓪	Transparent	10	0.027

⓪ Use contact elements LPXC10A (EM) and LPXC01 (NC) only.
Contact elements LPXC10 (NO) and LPXC01D (LB) cannot be fitted on these actuators.

Illuminated mushroom head button actuators



LPCBL614...



LPCBL664...

Order code	Colour	Qty per pkg	Wt
		n°	[kg]
SPRING RETURN. Ø40mm/1.6" (without mounting adapter).			
LPCBL6143	Green	10	0.035
LPCBL6144	Red	10	0.035
LPCBL6145	Yellow	10	0.035
LPCBL6146	Blue	10	0.035
LPCBL6148	White	1	0.035
LATCH, TURN TO RELEASE. Ø40mm/1.6" (without mounting adapter). For normal stopping.			
LPCBL6643	Green	1	0.040
LPCBL6645	Yellow	1	0.040
LPCBL6646	Blue	1	0.040
For emergency stopping, ISO 13850 compliant.			
LPCBL6644	Red	10	0.040

Operational characteristics

- Any mounting position allowed
- Ambient conditions:
 - Operating temperature: -25...+70°C
 - Storage temperature: -40...+85°C
- Degree of protection:
 - Per IEC/EN: IP66, IP67 and IP69K
 - Per UL: Type 1, 2, 3R, 4, 4X, 12, 12K.

Materials

Polyamide.

Mechanical endurance

- Operating force: <0.5kg/1.1lb (actuator).
Mechanical life:
- Spring return actuators: 5,000,000 cycles
 - Push-push actuators: 500,000 cycles
 - Spring return mushroom-head actuators: 5,000,000 cycles
 - Latch mushroom-head actuators: 300,000 cycles.

Mounting adapter

See page 7-36.

Type: LPXAU120.

Actuators are installed through a Ø22mm/Ø0.87" drilling with a threaded fixing ring (Tmax = 2.3Nm/20.3lb.in) also on the cover of LPZ... control stations.

The mounting adapter directly snaps onto the actuator.

Contact elements for illuminated spring return and mushroom-head latch actuators

See page 7-37 and 7-38.

Type	Termination
------	-------------

Front-mount types snap onto LPXAU120 mounting adapter (to purchase separately).

For TYPES LPCBL1/BL2/BL61... up to 6 contacts can be fitted: 3 each on the left and right, one behind the other.

For TYPES LPCBL66... up to 4 contacts can be fitted:

2 each on the left and right, one behind the other.

The LPXAU120 mounting adapter can also be fitted internally to the cover of the LPZ... control station with up to 2 elements per actuator in addition to the LED element in the middle position.

1NO	LPXC10	Screw
	LPXCF10	Faston
	LPXCS10	Spring clamp
1EM	LPXC10A	Screw
	LPXC01	Screw
1NC	LPXCF01	Faston
	LPXCS01	Spring clamp
	LPXC01D	Screw

Base mount types snap into LPZP... control station base.

See example on page 7-38.

Up to 2 contacts can be fitted per LPZ... control station actuator in addition to the LED element in the middle position.

1NO	LPXCB10	Screw
1NC	LPXCB01	Screw

Contact elements for illuminated push-push button actuators

See page 7-37.

Type: LPXC10A (1EM)
LPXC01 (1NC)

Contacts snap onto mounting adapter and also internally on the cover surface of LPZ... control stations.

Up to 4 contacts can be fitted: 2 each on the left and right, one behind the other; up to 2 elements per control station actuator in addition to the LED element in the middle position.

LED light elements

See pages 7-39 to 42.

Certifications and compliance

Certifications obtained: UL Listed for USA and Canada, (cULus - File E93601), as Auxiliary Devices; EAC, CCC, RINA. Compliant with standards: IEC/EN/BS 60947-1, IEC/EN/BS 60947-5-1, UL508, CSA C22.2 n° 14.

7 Pushbuttons and selector switches

PLatinum series
Ø22mm chromed plastic

INDEX

Double-touch actuators, spring return, white indicator



LPCBL71...



LPCBL72...

new

Order code	Colour	Symbol	Qty per pkg n°	Wt [kg]
Two flush pushbuttons (without mounting adapter). Both spring return.				
LPCBL7112	Black/Red	—	5	0.030
LPCBL7113	Green/Red	—	5	0.030
LPCBL7114	White/Black	—	1	0.030
LPCBL7122	Black/Red	I-O	5	0.030
LPCBL7123	Green/Red	I-O	5	0.030
LPCBL7124	White/Black	I-O	5	0.030
LPCBL7133	Green/Red	Start/Stop	5	0.030
LPCBL7191	Black/Black	↑ ↓	5	0.030

Order code	Colour	Symbol	Qty per pkg n°	Wt [kg]
One extended and one flush pushbuttons (without mounting adapter). Both spring return.				
LPCBL7212	Black/Red	—	1	0.030
LPCBL7213	Green/Red	—	5	0.030
LPCBL7214	White/Black	—	1	0.030
LPCBL7222	Black/Red	I-O	1	0.030
LPCBL7223	Green/Red	I-O	5	0.030
LPCBL7224	White/Black	I-O	5	0.030
LPCBL7233	Green/Red	Start/Stop	5	0.030

Illuminated selector switch actuators



LPCSL1...

Order code	Colour	Type of positions	Qty per pkg n°	Wt [kg]
2 positions (without mounting adapter).				
LPCSL1203	Green	∨	10	0.025
LPCSL1204	Red		10	0.025
LPCSL1205	Yellow		10	0.025
LPCSL1206	Blue		10	0.025
LPCSL1208	White		10	0.025
LPCSL1213	Green	∩	10	0.025
LPCSL1214	Red		1	0.025
LPCSL1215	Yellow		1	0.025
LPCSL1216	Blue		1	0.025
LPCSL1218	White		10	0.025

Order code	Colour	Type of positions	Qty per pkg n°	Wt [kg]
3 positions (without mounting adapter).				
LPCSL1303	Green	∨	10	0.025
LPCSL1304	Red		10	0.025
LPCSL1305	Yellow		10	0.025
LPCSL1306	Blue		10	0.025
LPCSL1308	White		10	0.025
LPCSL1313	Green	∩	10	0.025
LPCSL1314	Red		1	0.025
LPCSL1315	Yellow		1	0.025
LPCSL1316	Blue		1	0.025
LPCSL1318	White		10	0.025
LPCSL1323	Green	∩	10	0.025
LPCSL1324	Red		1	0.025
LPCSL1325	Yellow		1	0.025
LPCSL1326	Blue		1	0.025
LPCSL1328	White		10	0.025
LPCSL1333	Green	∩	10	0.025
LPCSL1334	Red		1	0.025
LPCSL1335	Yellow		1	0.025
LPCSL1336	Blue		1	0.025
LPCSL1338	White		10	0.025

Contact activation of 2-position selector switch

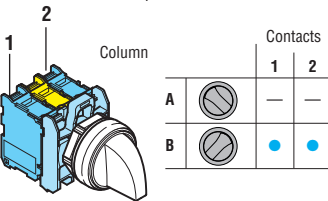

Contact activation of 3-position selector switch

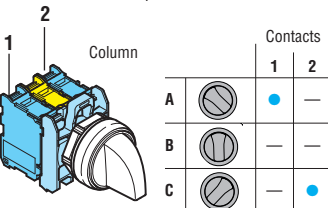

Operational characteristics

- Any mounting position allowed
- Ambient conditions:
 - Operating temperature: -25...+70°C
 - Storage temperature: -40...+85°C
- Degree of protection:
 - Per IEC/EN: IP66, IP67 and IP69K
 - Per UL: Type 1, 2, 3R, 4, 4X, 12, 12K.

Materials

Polyamide.

Mechanical endurance

- Operating force: <0.5kg/1.1lb (actuator).
- Mechanical life:
 - Double-touch: 1,000,000 cycles.
 - Selector switches: 1,000,000 cycles.

Mounting adapter

See page 7-36.

Type: LPXAU120.

Actuators are installed through a Ø22mm/Ø0.87" drilling with a threaded fixing ring (Tmax = 2.3Nm/20.3lb.in) also on the cover of LPZ... control stations.

The mounting adapter directly snaps onto the actuator.

Contact elements

See page 7-37 and 7-38.

Type	Termination
1NO	LPXC10 Screw
	LPXCF10 Faston
	LPXCS10 Spring clamp
1EM	LPXC10A Screw
1NC	LPXC01 Screw
	LPXCF01 Faston
	LPXCS01 Spring clamp
1LB	LPXC01D Screw

Front-mount types snap onto LPXAU120 mounting adapter (to purchase separately).
For DOUBLE-TOUCH TYPES, up to 6 contacts can be fitted: 3 each on the left and right, one behind the other.
For SELECTOR SWITCHES, up to 4 contacts can be fitted: 2 each on the left and right, one behind the other.
The LPXAU120 mounting adapter can also be fitted internally to the cover of the LPZ... control station with up to 2 elements per actuator in addition to the LED element in the middle position.

Base-mount types snap into LPZP... control station base.

See example on page 7-38.

Up to 2 contacts can be fitted per LPZ... control station actuator in addition to the LED element in the middle position.

1NO	LPXCB10	Screw
1NC	LPXCB01	Screw

Selector switch type of positions

- ∨ Maintained position.
- ∩ Spring return position.

Selector switch rotation angles



LED light elements

See pages 7-39 to 42.

Certifications and compliance

Certifications obtained: UL Listed for USA and Canada, (cULus - File E93601), as Auxiliary Devices; EAC, CCC, RINA. Compliant with standards: IEC/EN/BS 60947-1, IEC/EN/BS 60947-5-1, UL508, CSA C22.2 n° 14.

7 Pushbuttons and selector switches

PLatinum series
Ø22mm chromed plastic



INDEX

Pilot light heads



LPL...

Order code	Colour	Qty	Wt
		per pkg	
		n°	[kg]
Without mounting adapter.			
LPL3	Green	10	0.024
LPL4	Red	10	0.024
LPL5	Yellow	10	0.024
LPL6	Blue	10	0.024
LPL7	Transparent	10	0.024
LPL1187	Transparent ⚡ ⚠	10	0.024

⚡ ⚠ With symbol indicating dangerous voltage (IEC/EN/BS 60417 5036-a).

Operational characteristics

- Any mounting position allowed
- Ambient conditions:
 - Operating temperature: -25...+70°C
 - Storage temperature: -40...+85°C
- Degree of protection:
 - Per IEC/EN: IP66, IP67 and IP69K
 - Per UL: Type 1, 2, 3R, 4, 4X, 12, 12K.

Materials

Polyamide.

Mounting adapter

See page 7-36.

Type: LPXAU120.

Pilot light heads are installed through a Ø22mm/Ø0.87" drilling with a threaded fixing ring (Tmax = 2.3Nm/20.3lb.in) also on the cover of LPZ... control stations, with LED element in central position. The mounting adapter directly snaps onto the actuator.

LED light elements

See pages 7-39 to 42.

Certifications and compliance

Certifications obtained: UL Listed for USA and Canada, (cULus - File E93601), as Auxiliary Devices; EAC, CCC, RINA. Compliant with standards: IEC/EN/BS 60947-1, IEC/EN/BS 60947-5-1, UL508, CSA C22.2 n° 14.

USB and RJ45 communication interfaces



LPCD01



LPCD05



LPCD01L...

new

new

Order code	Description	Qty	Wt
		per pkg	
		n°	[kg]
LPCD01	USB interface, A/A female type connection	1	0.018
LPCD01L050	USB interface, A/A female connection with 0.5m long cable	1	0.050
LPCD01L100	USB interface, A/A female connection with 1m long cable	1	0.080
LPCD03	USB interface, A/B female type connection	1	0.018
LPCD05	USB interface, B/A female type connection	1	0.018
LPCD06	RJ45 interface, Ethernet connection type	1	0.026
LPCD06L100	RJ45 interface, Ethernet connection with 1m long cable	1	0.090

General characteristics

USB and RJ45 communication interface connectors are used in industrial environments, which in recent years have seen an increase in the number of connections between machines, production lines, equipment and measuring instruments. These interfaces provide the transmission of data in both directions between the various devices.

Operational characteristics

- Rated insulation voltage for LPCD01, LPCD03, LPCD05: 5VAC/DC
- Rated insulation voltage for LPCD06: 24VAC
- Installed through a Ø22mm/Ø0.87" drilling with a threaded fixing ring (Tmax = 2.3Nm/20.3lb.in) also on the cover of LPZ... control stations
- Transmission characteristics for LPCD01, LPCD03, LPCD05: 5Gbps (625MB/sec)
- Transmission characteristics for LPCD06: Cat.5E
- Rated current for LPCD01, LPCD03, LPCD05: 1.8A
- Rated current for LPCD06: 1.5A
- Insulation resistance: ≥100MΩ
- Contact resistance for LPCD01, LPCD03, LPCD05: ≤30mΩ
- Contact resistance for LPCD06: ≤40mΩ
- USB connector class: 3.0 (backward compatible with USB class 2.0)
- Ambient conditions:
 - Operating temperature: -25...+70°C
 - Storage temperature: -40...+85°C
- Degree of protection:
 - Per IEC/EN: IP65 on front (with cap mounted)
 - Per IEC/EN: IP20 at rear
 - Per UL: Type 1, 2, 3R, 4, 4X, 12, 12K on front (with cap mounted)

Materials

Polyamide.

Certifications and compliance

Certifications: cULus, EAC, CCC. Compliant with standards: IEC/EN/BS 60947-1, IEC/EN/BS 60947-5-1, UL508, CSA C22.2 n° 14.

LED integrated monoblock pilot lights steady light



LPM...

new

new

new

Order code	Rated auxiliary supply voltage	LED colour	Qty per pkg	Wt
			n°	[kg]
LPMLA1	12VAC/DC	Orange	10	0.021
LPMLA3		Green	10	0.021
LPMLA4		Red	10	0.021
LPMLA5		Yellow	10	0.021
LPMLA6		Blue	10	0.021
LPMLA7		Transparent	10	0.021
LPMLB1		24VAC/DC	Orange	10
LPMLB3	Green		10	0.021
LPMLB4	Red		10	0.021
LPMLB5	Yellow		10	0.021
LPMLB6	Blue		10	0.021
LPMLB7	Transparent		10	0.021
LPMLD1	48VAC/DC		Orange	10
LPMLD3		Green	10	0.021
LPMLD4		Red	10	0.021
LPMLD5		Yellow	10	0.021
LPMLD6		Blue	10	0.021
LPMLD7		Transparent	10	0.021
LPMLE1		110...120VAC	Orange	10
LPMLE3	Green		10	0.024
LPMLE4	Red		10	0.024
LPMLE5	Yellow		10	0.024
LPMLE6	Blue		10	0.024
LPMLE7	Transparent		10	0.024
LPMLM1	230VAC		Orange	10
LPMLM3		Green	10	0.024
LPMLM4		Red	10	0.024
LPMLM5		Yellow	10	0.024
LPMLM6		Blue	10	0.024
LPMLM7		Transparent	10	0.024
LPMLP1		380...415VAC	Orange	10
LPMLP3	Green		10	0.024
LPMLP4	Red		10	0.024
LPMLP5	Yellow		10	0.024
LPMLP6	Blue		10	0.024
LPMLP7	Transparent		10	0.024
LPMLF1	110...125VDC		Orange	10
LPMLF3		Green	10	0.024
LPMLF4		Red	10	0.024
LPMLF5		Yellow	10	0.024
LPMLF6		Blue	10	0.024
LPMLF7		Transparent	10	0.024
LPMLN1		220VDC	Orange	10
LPMLN3	Green		10	0.024
LPMLN4	Red		10	0.024
LPMLN5	Yellow		10	0.024
LPMLN6	Blue		10	0.024
LPMLN7	Transparent		10	0.024

Operational characteristics

- Rated frequency: 50-60Hz
- Auxiliary supply voltage:
 - 110...125VDC, 220VDC (-15%...+10% Ue)
 - 12VAC/DC, 24VAC/DC, 48VAC/DC (-15%...+10% Ue)
 - 110...120VAC, 230VAC, 380...415VAC (-15%...+10% Ue)
- Consumption: ≤20mA
- Installed through a Ø22mm/Ø0.87" drilling with a threaded fixing ring (Tmax = 2.3Nm/20.3lb.in) also on cover of LPZ... control stations
- Electrical life: >30,000 hours
- Screw termination
- Side cable entry
- Maximum tightening torque: 0.8Nm/7lb.in
- Ambient conditions:
 - Operating temperature: -25...+70°C
- Degree of protection:
 - per IEC/EN: IP66, IP67 and IP69K on front; IP20 at rear
 - per UL: Type 1, 2, 3R, 4, 4X, 12, 12K on front.

Materials

Polyamide.

Maximum conductor cross section

1 or 21.5mm² or AWG16 cables.

Wiring diagram



Certifications and compliance

Certifications: cULus, EAC, CCC (only for LPMLD..., LPMLE... and LPMLM...).

Compliant with standards: IEC/EN/BS 60947-1, IEC/EN/BS 60947-5-1, UL508, CSA C22.2 n° 14.

Monoblock potentiometers



LPCPA...

Order code	Resistance value	Qty per pkg	Wt
		n°	[kg]
LPCPA001	1kΩ	1	0.040
LPCPA002	2.5kΩ	1	0.040
LPCPA005	5kΩ	1	0.040
LPCPA010	10kΩ	1	0.040
LPCPA050	50kΩ	1	0.040
LPCPA100	100kΩ	1	0.040
LPCPA500	500kΩ	1	0.040

General characteristics for monoblock potentiometers

Monoblock potentiometers are typically used for regulating the parameters of many devices (e.g. the speed of the electric motors through static converters).

The monoblock body design permits direct use of the potentiometer by panel fitting with fixing ring and subsequent tightening of cables into the built-in terminal block.

The potentiometer is made with Cermet technology, which ensures stable, constant resistance values over time. The, UL-certified, range is made for resistance values from 1 to 500kΩ. All potentiometers are IP66, IP67, IP69K and UL Type 4X, which means that they can be used in demanding ambient conditions.

Operational characteristics for monoblock potentiometers

- Rated insulation voltage U_i : 250VAC
- Impulse withstand voltage U_{imp} : 4kV
- Potentiometer included in the product
- Monoblock body with 1-turn graduated scale
- Any fitting position permitted
- Installed through a Ø22mm/Ø0.87" drilling with a threaded fixing ring ($T_{max} = 2.3Nm/20.3lb.in$) also on the cover of LPZ... control stations
- Resistive material: cermet
- Operation: linear
- Resistance tolerance: ±10%
- Max. power: 0.5W (70°C)
- Mechanical endurance: 25,000 operations
- Mechanical travel: 290°
- Side cable entry
- Ambient conditions:
 - Operating temperature: -25...+70°C
 - Storage temperature: -40...+85°C
- Degree of protection:
 - Per IEC/EN: IP66, IP67 and IP69K on front
 - Per IEC/EN: IP20 at rear
 - Per UL: Type 1, 2, 3R, 4, 4X, 12, 12K on front.

Monoblock buzzers



LPCZS...

Order code	Voltage	Sound intensity at 2800Hz	Qty per pkg.	Wt
	[V]	[dB/10cm]	n°	[kg]
Continuous or pulse tone, IP40 version.				
LPCZSA	9...15VAC/DC	90	1	0.020
LPCZSB	18...30VAC/DC	90	1	0.020
LPCZSE	85...140VAC/DC	90	1	0.020
LPCZSM	185...265VAC/DC	90	1	0.020
Continuous or pulse tone, IP66, IP67, IP69K and UL Type 4X version.				
LPCZSAIP	9...15VAC/DC	80	1	0.020
LPCZSBIP	18...30VAC/DC	80	1	0.020
LPCZSEIP	85...140VAC/DC	80	1	0.020
LPCZSMIP	185...265VAC/DC	80	1	0.020

General characteristics for monoblock buzzers

Monoblock buzzers are used as sound indicators in automation systems and on-board machinery in the production processes. Long life, low consumption values, compact size and the use of materials, in accordance with the North American market, are the main features of this product.

Operational characteristics for monoblock buzzers

- Rated frequency: 50...60Hz
- Auxiliary supply voltage: 9...15VAC/DC, 18...30VAC/DC, 85...140VAC/DC, 185...265VAC/DC
- Maximum consumption: 20mA-0.30W (type 9...15VAC/DC), 15mA-0.40W (type 18...30VAC/DC), 5.5mA-0.80W (type 85...140VAC/DC), 3.5mA-0.95W (type 185...265VAC/DC)
- Minimum activation voltage: >4V (type 9...15VAC/DC), >8V (type 18...30VAC/DC), >15V (type 85...140VAC/DC), >25V (type 185...265VAC/DC)
- Impulse withstand voltage U_{imp} : 4kV
- Installed through a Ø22mm/Ø0.87" drilling with a threaded fixing ring ($T_{max} = 2.3Nm/20.3lb.in$) also on the cover of LPZ... control stations
- Service life: 30,000 hours (permanently powered)
- Side cable entry
- Ambient conditions:
 - Operating temperature: -25...+70°C
 - Storage temperature: -40...+85°C
- Degree of protection (type LPCZS...):
 - Per IEC/EN: IP40 on front and IP20 at rear
- Degree of protection (type LPCZS...IP):
 - Per IEC/EN: IP66, IP67, IP69K on front and IP20 at rear
 - Per UL: Type 1, 2, 3R, 4, 4X, 12, 12K on front.



LPCZS...IP

Pulse-tone sound graph

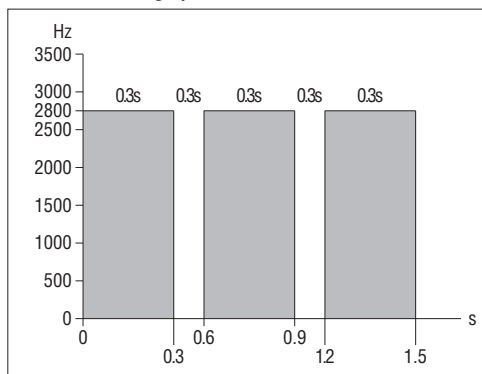

Materials

Polyamide.

Maximum conductor cross section

Screw terminal connections with three separate connections:

- Min. cable 0.5mm² / AWG24
- Max. cable 2.5mm² / AWG14
- Maximum tightening torque: 0.5Nm/4.4lb.in
- Flat-head screwdriver: 0.6x3.5mm/0.02x0.14"

Certifications and compliance

Certifications: cULus, EAC, CCC.
Compliant with standards: IEC/EN/BS 60947-1, IEC/EN/BS 60947-5-1, UL508, CSA C22.2 n° 14.

Pushbutton actuators, spring return, with special symbols



LPSB1253

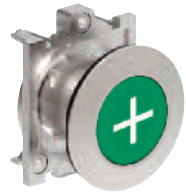

LPFB1253



LPCB1253

Order code	Symbol	Colour	Qty per pkg	Wt
			n°	[kg]
Spring return (without mounting adapter).				
LPOB00250	+	①	50	0.027
LPOB00260	-	①	50	0.027
LPOB00270		①	50	0.027
LPOB00280		①	50	0.027
LPOB00290		①	50	0.027
LPOB00300		①	50	0.027
LPOB00310		①	50	0.027
LPOB00320		①	50	0.027
LPOB00330		①	50	0.027
LPOB00340	MAN	①	50	0.027
LPOB00350	AUTO	①	50	0.027
LPOB00380	TRIP	①	50	0.027
LPOB00390	TEST	①	50	0.027
LPOB00400		①	50	0.027
LPOB00410		①	50	0.027
LPOB00420		①	50	0.027
LPOB00430		①	50	0.027
LPOB00440		①	50	0.027
LPOB00450		①	50	0.027
LPOB00460		①	50	0.027
LPOB00470		①	50	0.027
LPOB00480		①	50	0.027
LPOB00490		①	50	0.027
LPOB00520		①	50	0.027
LPOB00530		①	50	0.027
LPOB00540		①	50	0.027
LPOB00550		①	50	0.027
LPOB00560	START STOP	①	50	0.027
LPOB00570	III	①	50	0.027
LPOB00580	IV	①	50	0.027
LPOB00590		①	50	0.027
LPOB00600		①	50	0.027
LPOB00610		①	50	0.027
LPOB00620		①	50	0.027
LPOB00630		①	50	0.027
LPOB00640		①	50	0.027
LPOB00650		①	50	0.027
LPOB00660		①	50	0.027
LPOB00670		①	50	0.027
LPOB00680		①	50	0.027
LPOB00690		①	50	0.027

① Add letter "S" if Ø22mm metal type is required; "F" if Ø30mm flat metal type is required; "C" if Ø22mm chromed plastic type is required.
 ② Add letter "L" if illuminated type is required.
 ③ or the type of actuator, add: 1 for flush or 2 for extended.
 ④ Add the actuator colour: 2 black only for non-illuminated type; 3 green, 4 red, 5 yellow, 6 blue, 8 white or 7 transparent for illuminated version.
 ⑤ Products available on specific request for a minimum multiple quantity of 50 pieces per type.
 ⑥ Consult Technical support for assistance; see contact details or inside front cover.
 ⑦ Symbol indicating dangerous voltage (IEC 60417 5036-a).
 Examples of complete order codes:
 LPSB2258 - Ø22mm metal white extended pushbutton with + symbol;
 LPFB1685 - Ø30mm illuminated flat metal yellow flush pushbutton with symbol;
 LPCB1344 - Ø22mm chromed plastic green flush pushbutton with "AUTO" symbol.

Operational characteristics

- Any mounting position allowed
- Ambient conditions:
 - Operating temperature: -25...+70°C
 - Storage temperature: -40...+85°C
- Degree of protection:
 - Per IEC/EN: IP66, IP67 and IP69K
 - Per UL: Type 1, 2, 3R, 4, 4X, 12, 12K.

Materials

Polyamide.

Mechanical endurance

Operating force: <0.5kg/1.1lb (actuator).
 Mechanical life: 5,000,000 cycles.

Mounting adapter

See page 7-36.
 Type: LPXAU120...

Contact elements

See page 7-37 and 7-38.

Type	Termination
1NO	LPXC10 Screw
	LPXCF10 Faston
	LPXCS10 Spring clamp
1EM	LPXC10A Screw
1NC	LPXC01 Screw
	LPXCF01 Faston
	LPXCS01 Spring clamp
1LB	LPXC01D Screw

Base mount types snap into LPZP... control station base. See example on page 7-38.

Up to 3 elements can be fitted to the adapter when used with the LPZ... control station.

1NO	LPXCB10	Screw
1NC	LPXCB01	Screw

All these actuators are standard-supplied with action plug for middle contacts.

Certifications and compliance

Certifications obtained: cULus, EAC, CCC, RINA.
 Compliant with standards: IEC/EN/BS 60947-1, IEC/EN/BS 60947-5-1, UL508, CSA C22.2 n° 14.

Mounting adapters



LPXAU120M



LPXAU120

new

Order code	Description	Qty per pkg	Wt
		n°	[kg]
LPXAU120M	Mounting adapter for metal actuators (LPS... and LPE...)	10	0.019
LPXAU120	Mounting adapter for chromed plastic actuators (LPC...)	10	0.004

Rear view
(reference for element installation)

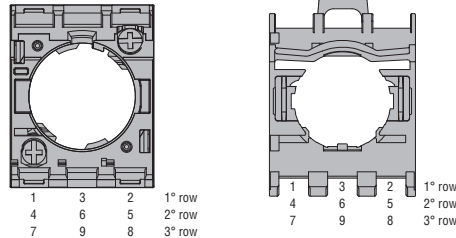

Mounting adapters with contact elements



LPXE...M

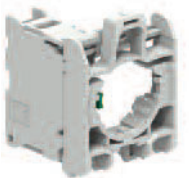

LPXE...

new

Order code	Funzione	Qty per pkg	Wt
		n°	[kg]

Screw termination contact elements. For metal actuators LPS... and LPE... With LPXAU120M mounting adapter.

LPXE10M		5	0.030
LPXE01M		5	0.030

Screw termination contact elements. For chromed plastic actuators LPC... With LPXAU120 mounting adapter.

LPXE10		10	0.015
LPXE01		10	0.015

- ① Use LPXC10A (EM) or LPXC01 (NC) type only with push-push actuators. Not suitable for push-push actuators.
- ② Direct (positive) opening action in accordance with IEC/EN/BS 60947-5-1.

Drillings

Minimum recommended distances for Ø22mm/0.87" actuators.

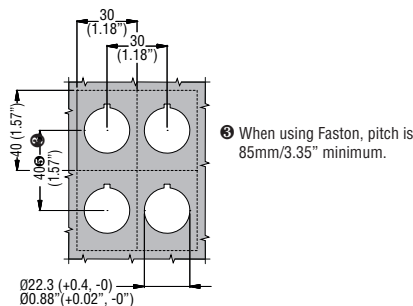

Minimum recommended distances for Ø30mm/1.18" actuators.

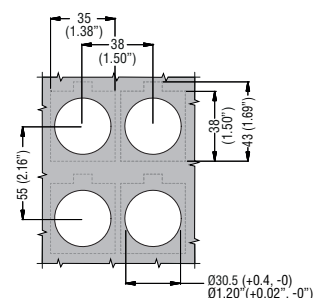

Operational characteristics

- Any mounting position allowed
- for LPXAU120M: the base is fixed to the mounting surface by 2 screws incorporated in the base (Tmax = 0.7Nm/6.1lb.in)
- Ambient conditions:
 - Operating temperature: -25...+70°C
 - Storage temperature: -40...+85°C
- Degree of protection:
 - IP20 for screw termination
 - IP00 for Faston termination.

General characteristics of contact elements

Wiping effect, dual scraping-oscillating action
IEC rated insulation voltage: 690V
IEC rated thermal current Ith: 10A
Conductivity: 5V 1mA
UL/CSA and IEC/EN/BS 60947-5-1 designation: A600 Q600.

IEC/EN operational characteristics in AC15 category:

[V]	12	24	48	120	240	400	480	500	600
[A]	6	6	6	6	6	3	1.5	1.4	1.2

IEC/EN operational characteristics in DC13 category:

[V]	12	24	48	125	250	440	500	600
[A]	3	3	1.5	0.55	0.27	0.15	0.13	0.1

Short-circuit protection fuse: max calibre: 10A gG/SC.

Contact resistance: ≤20mΩ.

Terminals: Clamp screw with washer.

Stroke of contact elements

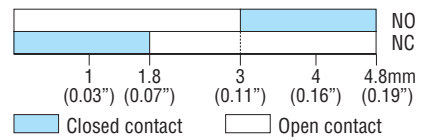

Maximum conductor cross section for screw terminals

1 or 2 2.5mm² or AWG14 cables.

Mechanical and electrical endurance

Operating force: ≤0.5kg/1.1lb (auxiliary contacts).
Electrical life: 1,000,000 cycles.

Certifications and compliance

Certifications: EAC, cULus, CCC, RINA.
Compliant with standards: IEC/EN/BS 60947-1, IEC/EN/BS 60947-5-1, UL508, CSA C22.2 n° 14.

Contact elements with screw terminals

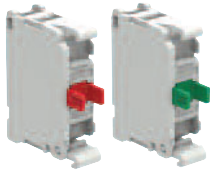

LPXC...

Order code	Function	Qty per pkg	Wt
		n°	[kg]
Screw termination. Without mounting adapter.			
LPXC10①	 NO①	10	0.011
LPXC10A	 EM②	10	0.011
LPXC01 ⊖	 NC③	10	0.011
LPXC01D① ⊖	 LB①③④	10	0.011

- ① Use LPXC10A (EM) or LPXC01 (NC) type only with push-push actuators. Not suitable for push-push actuators.
- ② Normally open contact with early-make operation and suitable for push-push actuators.
- ③ Direct (positive) opening action ⊖ in accordance with IEC/EN/BS 60947-5-1.
- ④ Normally closed contact with late break operation.

Contact elements with spring-clamp terminals

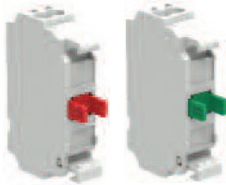

LPXCS01

LPXCS10

Order code	Function	Qty per pkg	Wt
		n°	[kg]
Spring-clamp termination. Without mounting adapter.			
LPXCS10①	 NO①	10	0.010
LPXCS01 ⊖	 NC③	10	0.010

- ① Not suitable for push-push actuators.
- ③ Direct (positive) opening action ⊖ in accordance with IEC/EN/BS 60947-5-1.

Push-in wiring technology for rigid cables or with ferrules only - no screwdriver needed
Cable retaining force guaranteed over time even in presence of vibrations and/or impacts

Push-in technology

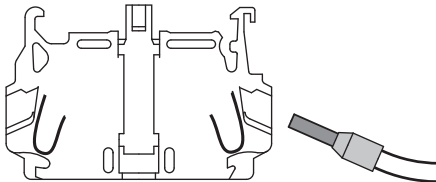

Wiring with flat-blade screwdriver (for flexible bare cable without terminal)

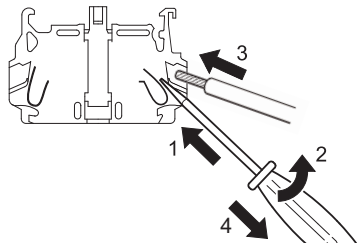

Cable removal (always using flat-blade screwdriver)

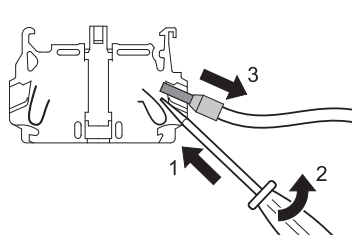

Operational characteristics for screw termination

- Any mounting position allowed
- Snap onto LPXAU120M or LPXAU120 mounting adapters:
 - See the combinations given under "Contact elements" in the right-hand column for each type of pushbutton and selector switch.
 - A maximum of 3 LPXCF... contacts or 2 contacts and 1 LED element (LPXL... mounted in the middle position) can be fixed internally on the cover surface of LPZ... control stations for each actuator
- Max. tightening torque for screw terminals: 1Nm/8.8lb.in
- Ambient conditions:
 - Operating temperature: -25...+70°C
 - Storage temperature: -40...+85°C
- Degree of protection:
 - IP20 for screw termination
 - IP00 for Faston termination.

Operational characteristics for spring-clamp termination

- Any mounting position allowed
- Elements snap onto mounting adapter, also internally on LPZ... control station cover with maximum of 3 LPXCS... contact or 2 LPXCS... contact and 1 LPXLPS... LED elements (in middle position) per actuator
- No other element can be stacked behind LED elements
- See the combinations given under "Contact elements" in the right-hand column for each type of pushbutton and selector switch
- Suitable for applications with vibration and/or impact work conditions; cable retaining force guaranteed over time in these conditions
- For use with the test elements, see page 7-37
- Wiring also possible after installation with stacked contacts
- Ambient conditions:
 - Operating temperature: -25...+70°C
 - Storage temperature: -40...+85°C
- Degree of protection: IP20.

General characteristics of contact elements

Wiping action and dual scraping-oscillating effect
IEC rated insulation voltage: 690V
IEC rated thermal current Ith: 10A
Conductivity: 1mA 5V
UL/CSA and IEC/EN/BS 60947-5-1 designation: A600 Q600.

IEC/EN operational characteristics in AC15 category:

[V]	12	24	48	120	240	400	480	500	600
[A]	6	6	6	6	6	3	1.5	1.4	1.2

IEC/EN operational characteristics in DC13 category:

[V]	12	24	48	125	250	440	500	600
[A]	3	3	1.5	0.55	0.27	0.15	0.13	0.1

Short circuit protection fuse: max calibre: 10A gG/SC.

Contact resistance: ≤20mΩ.

Terminals: Clamp screw with washer.

Faston 1x6.35mm(0.25") or 2x2.8mm(0.11").

Stroke of contact elements

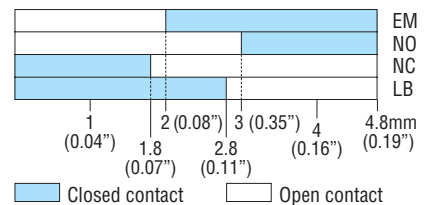

Maximum conductor cross section for screw terminals
1 or 2 2.5mm² or AWG14 cables.

Mechanical and electrical endurance

Operating force: ≤0.5kg/1.1lb (auxiliary contacts).
Electrical life: 1,000,000 cycles for LPXC10/01/E01/10, LPXC01SM/02SM, LPXCF10/01; 600,000 cycles for LPXC10A/01D.

Certifications and compliance

Certifications obtained: UL Listed for USA and Canada, (cULus - File E93601), as Auxiliary Devices; EAC, CCC, RINA.
Compliant with standards: IEC/EN/BS 60947-1, IEC/EN/BS 60947-5-1, UL508, CSA C22.2 n° 14.

Contact elements with Faston terminals



LPXCF01 LPXCF10

Order code	Function	Qty per pkg	Wt
		n°	[kg]

Faston termination. Without mounting adapter.

LPXCF10		10	0.012
LPXCF01		10	0.012

- ① Use LPXC10A (EM) or LPXC01 (NC) type only with push-push actuators. Not suitable for push-push actuators.
- ② Direct opening operation \ominus in accordance with IEC/EN/BS 60947-5-1.

Auto-monitoring contact elements with screw terminals

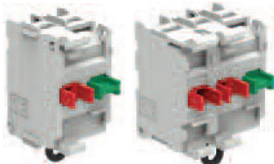

LPXC01SM LPXC02SM

Order code	Function	Qty per pkg	Wt
		n°	[kg]

Screw termination. Without mounting adapter.
Auto-monitor contact elements for non-illuminated latch mushroom-head pushbuttons.

LPXC01SM		1	0.022
LPXC02SM		1	0.033

- ① Use LPXC10A (EM) or LPXC01 (NC) type only with push-push actuators. Not suitable for push-push actuators.
- ② Direct opening operation \ominus in accordance with IEC/EN/BS 60947-5-1.

Contact elements, base mount on LPZP... control stations with screw terminals

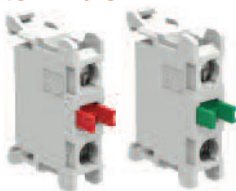

LPXCB...

Order code	Function	Qty per pkg	Wt
		n°	[kg]

Screw termination.
Direct snap-on mounting on LPZP... control station base.

LPXCB10		10	0.012
LPXCB01		10	0.012

- ① Not suitable for push-push actuators.
- ② Direct opening operation \ominus in accordance with IEC/EN/BS 60947-5-1.

Mounting position on the LPZP... control station base

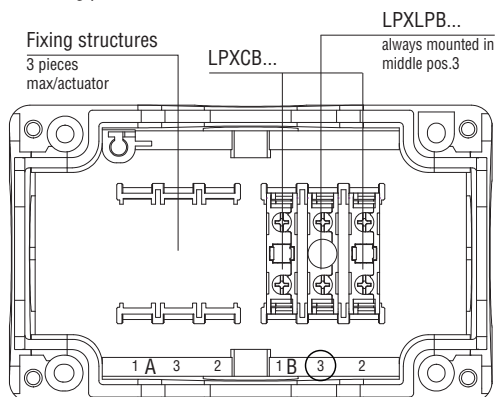

General characteristics

- Any mounting position allowed
- Max. tightening torque for screw terminals: 1Nm/8.8lb.in
- Ambient conditions:
 - Operating temperature: -25...+70°C
 - Storage temperature: -40...+85°C
- Degree of protection: IP20 for screw termination, IP00 for Faston termination.

Operational characteristics for Faston termination and auto-monitoring contact elements

- Snap onto LPXAU120M or LPXAU120 mounting adapters:
 - A maximum of 3 LPXCF... contacts or 2 contacts and 1 LED element (LPXL... mounted in the middle position) can be fixed internally on the cover surface of LPZ... control stations for each actuator
- A maximum of 2 LPXC...SM contacts can be installed on adapters exclusively on non-illuminated mushroom-head latch actuators:
 - In pos. 1-3 (on the left side only of the mounting adapters; refer to REAR VIEW drawing), one only LPXC01SM or LPXC02SM element can be fitted
 - One extra LPX...SM can be installed in pos. 4-6 (stacked behind the LPX...SM on the mounting adapters)
 - With LPXC01SM, a maximum of two contacts LPXC0... or LPXC1... can be fitted on the right side of the mounting adapters in pos. 2 and 5, one behind the other
 - On the internal surface of LPZ... control station covers, one only LPXC01SM or LPXC02SM contact can be mounted on the mounting adapters in pos. 1 (on the left).
With LPXC01SM, one extra element LPXC0... or LPXC1... can be fitted on the right (on the mounting adapters in pos. 2).
 - No LED element can be used with LPXC...SM types.

Operational characteristics for base mount on LPZP... control stations contact elements

- Snap-on mounting into fixing structures of LPZP... control station base
- Maximum of 3 LPXCB... contact or 2 LPXCB... contact and 1 LPXLPB... LED elements (in middle pos. 3) for each actuator of LPZP... control stations
- For use with test elements, consult Technical support; see contact details on inside front cover

Mounting adapter

See page 7-36.

General characteristics

Wiping action and dual scraping-oscillating effect
IEC rated insulation voltage: 690V
IEC rated thermal current Ith: 10A
Conductivity: 5V 1mA
UL/CSA and IEC/EN/BS 60947-5-1 designation: A600 Q600.

IEC/EN operational characteristics in AC15 category:

[V]	12	24	48	120	240	400	480	500	600
[A]	6	6	6	6	6	3	1.5	1.4	1.2

IEC/EN operational characteristics in DC13 category:

[V]	12	24	48	125	250	440	500	600
[A]	3	3	1.5	0.55	0.27	0.15	0.13	0.1

Short-circuit protection fuse: max calibre: 10A gG/SC.

Contact resistance: $\leq 20\text{m}\Omega$.

Terminals: Clamp screw with washer.

Faston 1x6.35mm(0.25") or 2x2.8mm(0.11").

Stroke of contact elements

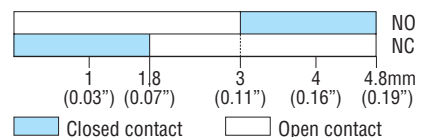

Mechanical and electrical endurance of contact elements

Opening force: $\leq 0.5\text{kg}/1.1\text{lb}$

Electrical life: 1,000,000 cycles for LPXCS10 and LPXCS01.

Maximum conductor cross section

1 or 2 2.5mm² or AWG14 cables. For 2.5mm² section, use rounded cable terminal with metal end at least 10mm.

Certifications and compliance

Certifications obtained: UL Listed for USA and Canada, (cULus - File E93601), as Auxiliary Devices; EAC, CCC, RINA. Compliant with standards: IEC/EN/BS 60947-1, IEC/EN/BS 60947-5-1, UL508, CSA C22.2 n° 14.

Test elements for steady light LED elements with screw terminals



LPXT...

Order code	Description	Qty per pkg	Wt
		n°	[kg]
Screw termination. Without mounting adapter.			
LPXT100 ①②	Use with LED elements in AC/DC, types LPXLE... (all), LPXLFB..., LPXLPB and LPXLPSB...	10	0.011
LPXT101 ②	Use with LED elements at 85-140VAC for types LPXLFE..., LPXLPE... and LPXLPE...	10	0.011
LPXT102 ②	Use with LED elements at 185-265VAC for types LPXLFM..., LPXLPM... and LPXLPSM...	10	0.011

- ① Whenever test circuits include illuminated actuators connected with paralleled load, use two LPXT100 for each LED element. Refer to the wiring diagram below or online in the Downloads section at www.LovatoElectric.com
- ② With DC supply only for LPXT100 type, the LED element works at full voltage and brightness while with AC supply for all LPXT... types, the LED element works at half voltage with reduced brightness level.

For LPXT100 test element

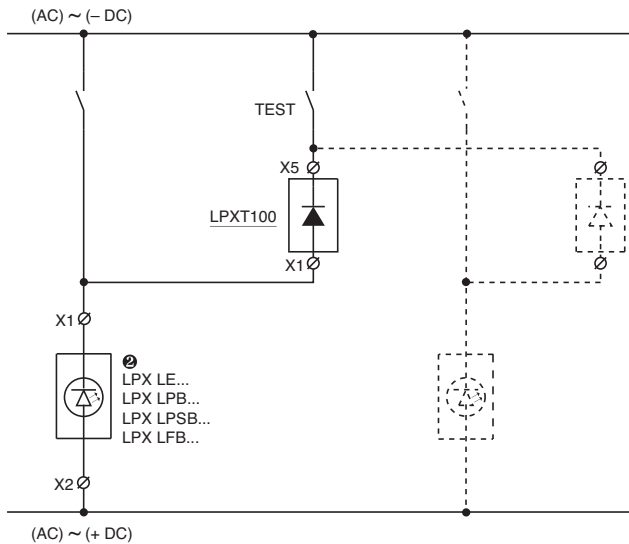

For LPXT101 and LPXT102 test elements

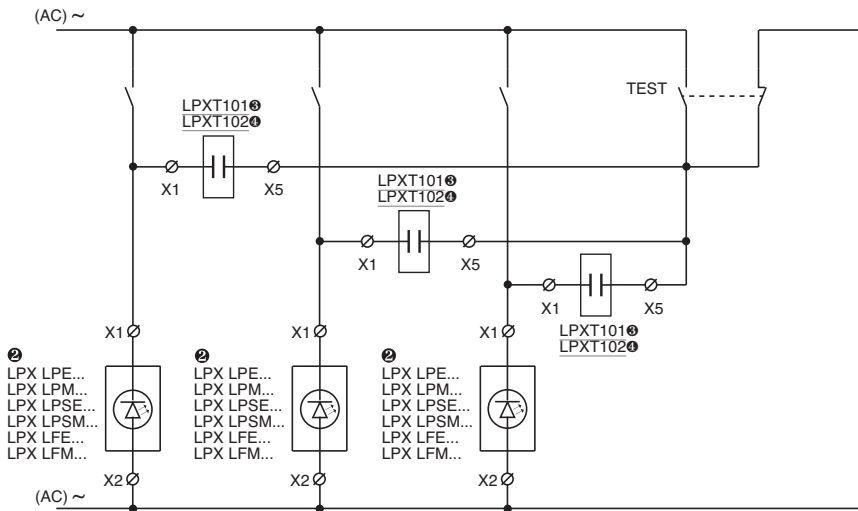

- ② Use with LPXLFE..., LPXLPE... or LPXLPE... type.
- ③ Use with LPXLFM..., LPXLPM... or LPXLPSM... type.

Operational characteristics

- Auxiliary supply voltage:
 - LPXT100 test element:
 - 12...30VAC/DC for LPXLEB/LFB/LPB/LPSB...
 - 85...140VAC/DC for LPXLEE...
 - 185...265VAC/DC for LPXLEM...
 - LPXT101 test element: 85...140VAC
 - LPXT102 test element: 185...265VAC
- For use with LED elements LPXLPBB/LPBE/LPBM... types, consult Technical support; see contact details on inside front cover
- Electrical life: 100,000 hours
- Any mounting position allowed
- Snap onto mounting adapter beside the LED element or stacked behind contact elements; also internally on the LPZ... control station cover
- Maximum tightening torque: 1Nm/8.8lb.in
- Ambient conditions:
 - Operating temperature: -25...+70°C
 - Storage temperature: -40...+85°C
- Degree of protection: IP20.

Mounting adapter

See page 7-36.

The mounting adapter directly snaps onto the actuator fixed to the mounting surface.

Maximum conductor cross section

1 or 2 2.5mm² or AWG 12 cables.

Wiring diagram

For LPXT100



For LPXT101 - LPXT102



Certifications and compliance

Certifications obtained: UL Listed for USA and Canada, (cULus - File E93601), as Auxiliary Devices; EAC, CCC, RINA. Compliant with standards: IEC/EN/BS 60947-1, IEC/EN/BS 60947-5-1, UL508, CSA C22.2 n° 14.

LED elements steady light with screw terminals



LPXLP...

Total protection against overvoltages and stray currents in wiring, to reduce flickering phenomenon and withstand vibrations.

Order code	Rated supply voltage	LED colour	Qty per pkg.	Wt
	[V]		n°	[kg]
Steady light, screw termination. Without mounting adapter.				
LPXLPB3	12...30V AC/DC	Green	10	0.016
LPXLPB4		Red	10	0.016
LPXLPB5		Yellow	10	0.016
LPXLPB6		Blue	10	0.016
LPXLPB8		White	10	0.016
LPXLPE3	85...140V AC	Green	10	0.016
LPXLPE4		Red	10	0.016
LPXLPE5		Yellow	10	0.016
LPXLPE6		Blue	10	0.016
LPXLPE8		White	10	0.016
LPXLPM3	185...265V AC	Green	10	0.016
LPXLPM4		Red	10	0.016
LPXLPM5		Yellow	10	0.016
LPXLPM6		Blue	10	0.016
LPXLPM8		White	10	0.016



LPXLE...

Simple protection against overvoltages and to withstand vibrations.

Order code	Rated supply voltage	LED colour	Qty per pkg.	Wt
	[V]		n°	[kg]
Steady light, screw termination. Without mounting adapter.				
LPXLEB3	12...30V AC/DC	Green	10	0.016
LPXLEB4		Red	10	0.016
LPXLEB5		Yellow	10	0.016
LPXLEB6		Blue	10	0.016
LPXLEB8		White	10	0.016
LPXLED3	48VAC/DC	Green	10	0.016
LPXLED4		Red	10	0.016
LPXLED5		Yellow	10	0.016
LPXLED6		Blue	10	0.016
LPXLED8		White	10	0.016
LPXLEE3	85...140V AC/DC	Green	10	0.016
LPXLEE4		Red	10	0.016
LPXLEE5		Yellow	10	0.016
LPXLEE6		Blue	10	0.016
LPXLEE8		White	10	0.016
LPXLEM3	185...265V AC/DC	Green	10	0.016
LPXLEM4		Red	10	0.016
LPXLEM5		Yellow	10	0.016
LPXLEM6		Blue	10	0.016
LPXLEM8		White	10	0.016

Operational characteristics

- Rated frequency: 50-60Hz
- Auxiliary supply voltage:
 - LPXLP...: 12...30VAC/DC; 85...140VAC; 185...265VAC
 - LPXLE...: 12...30VAC/DC; 85...140VAC/DC; 185...265VAC/DC
- Maximum consumption:
 - LPXLP...: 17mA-0.50W (12...30VAC/DC); 20mA-0.40W (85...140VAC); 18mA-0.55W (185...265VAC)
 - LPXLE...: 11mA-0.33W (12...30VAC/DC); 5mA-0.72W (85...140VAC/DC); 3mA-0.67W (185...265VAC/DC)
- Total protection for LPXLP... types:
 - Against overvoltages
 - Against stray currents in wiring
 - To reduce flickering phenomenon
 - To withstand vibrations
- Simple protection for LPXLE... types:
 - Against overvoltages
 - To withstand vibrations
- Minimum activation voltage:
 - LPXLP...: 4V-1mA (12...30VAC/DC); 30V-4mA (85...140VAC); 55V-4mA (185...265VAC)
 - LPXLE...: 4V-0.5mA (12...30VAC/DC); 15V-0.4mA (85...140VAC/DC); 35V-0.3mA (185...265VAC/DC)
- Electrical life: 100,000 hours
- Snap onto LPXAU120M or LPXAU120 mounting adapter in the middle position for each illuminated actuator, also internally on the LPZ... control station cover
- No other element can be stacked behind LED elements
- Any mounting position allowed
- Maximum tightening torque: 1Nm/8.8lb.in
- Ambient conditions:
 - Operating temperature: -25...+70°C (-25...+60°C for LPXLE...)
 - Storage temperature: -40...+85°C
- Degree of protection: IP20.

Mounting adapter

See page 7-36.

The mounting adapter directly snaps onto the actuator fixed to the mounting surface.

Maximum conductor cross section

1 or 2 2.5mm² or AWG12 cables.

Wiring diagram



Certifications and compliance

Certifications obtained: UL Listed for USA and Canada, (cULus - File E93601), as Auxiliary Devices; EAC, CCC, RINA. Compliant with standards: IEC/EN/BS 60947-1, IEC/EN/BS 60947-5-1, UL508, CSA C22.2 n° 14.

LED elements flashing light with screw terminals



LPXLF...

Total protection against overvoltages and stray currents in wiring, to reduce flickering phenomenon and withstand vibrations.

Order code	Rated supply voltage	LED colour	Qty per pkg.	Wt
	[V]		n°	[kg]

Flashing light, screw termination.
Without mounting adapter.

LPXLFB3	18...30V AC/DC	Green	10	0.016
LPXLFB4		Red	10	0.016
LPXLFB5		Yellow	10	0.016
LPXLFB6		Blue	10	0.016
LPXLFB8		White	10	0.016
LPXLFE3	85...140V AC	Green	10	0.016
LPXLFE4		Red	10	0.016
LPXLFE5		Yellow	10	0.016
LPXLFE6		Blue	10	0.016
LPXLFE8		White	10	0.016
LPXLFM3	185...265V AC	Green	10	0.016
LPXLFM4		Red	10	0.016
LPXLFM5		Yellow	10	0.016
LPXLFM6		Blue	10	0.016
LPXLFM8		White	10	0.016

Operational characteristics

- Rated frequency: 50-60Hz
- Auxiliary supply voltage:
 - LPXLF...: 18...30VAC/DC; 85...140VAC, 185...265VAC
- Maximum consumption:
 - 17mA-0.50W (12...30VAC/DC); 20mA-0.40W (85...140VAC); 18mA-0.55W (185...265VAC)
- Total protection:
 - Against overvoltages
 - Against stray currents in wiring
 - To reduce flickering phenomenon
 - To withstand vibrations
- Minimum activation voltage:
 - 5V-1.5mA (18...30VAC/DC); 13V-1.5mA (85...140VAC); 25V-1.5mA (185...265VAC)
- Electrical life: 100,000 hours
- Snap onto mounting adapter in the middle position for each illuminated actuator, also internally on the LPZ... control station cover
- No other element can be stacked behind LED elements
- Any mounting position allowed
- Maximum tightening torque: 1Nm/8.8lb.in
- Ambient conditions:
 - Operating temperature: -25...+70°C (-25...+60°C for LPX LE...)
 - Storage temperature: -40...+85°C
- Degree of protection: IP20.

Mounting adapter

See page 7-36.

The mounting adapter directly snaps onto the actuator fixed to the mounting surface.

Maximum conductor cross section

1 or 2 2.5mm² or AWG12 cables.

Wiring diagram



Certifications and compliance

Certifications obtained: UL Listed for USA and Canada, (cULus - File E93601), as Auxiliary Devices; EAC, CCC, RINA. Compliant with standards: IEC/EN/BS 60947-1, IEC/EN/BS 60947-5-1, UL508, CSA C22.2 n° 14.

LED elements steady light with spring-clamp terminals



LPXLPS...

Total protection against overvoltages and stray currents in wiring, to reduce flickering phenomenon and withstand vibrations.

Order code	Rated supply voltage	LED colour	Qty per pkg	Wt
	[V]		n°	[kg]

Steady light, with spring-clamp termination.
Without mounting adapter.

LPXLPSB3	12...30VAC/DC	Green	10	0.015
LPXLPSB4		Red	10	0.015
LPXLPSB5		Yellow	10	0.015
LPXLPSB6		Blue	10	0.015
LPXLPSB8		White	10	0.015
LPXLPE3	85...140VAC	Green	10	0.015
LPXLPE4		Red	10	0.015
LPXLPE5		Yellow	10	0.015
LPXLPE6		Blue	10	0.015
LPXLPE8		White	10	0.015
LPXLPSM3	185...265VAC	Green	10	0.015
LPXLPSM4		Red	10	0.015
LPXLPSM5		Yellow	10	0.015
LPXLPSM6		Blue	10	0.015
LPXLPSM8		White	10	0.015

Push-in wiring technology for rigid cables or with ferrules only - no screwdriver needed
Cable retaining force guaranteed over time even in presence of vibrations and/or impacts

Push-in technology

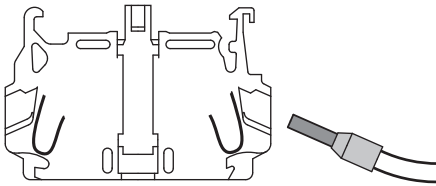

Wiring with flat-blade screwdriver
(for flexible bare cable without terminal)

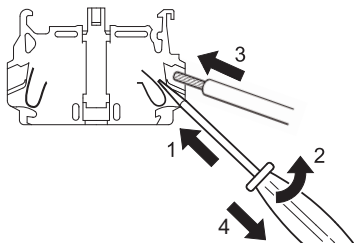

Cable removal
(always using flat-blade screwdriver)

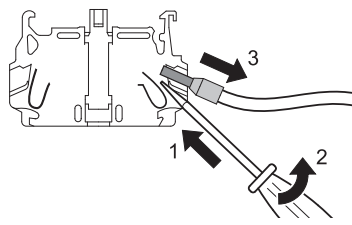

Operational characteristics

- Any mounting position allowed
- Elements snap onto adapter, also internally on LPZ... control station cover (in middle position) per actuator
- No other element can be stacked behind LED elements
- See the combinations given under "Contact elements" in the right-hand column for each type of pushbutton and selector switch
- Suitable for applications with vibration and/or impact work conditions; cable retaining force guaranteed over time in these conditions
- For use with the test elements, see page 7-37
- Wiring also possible after installation with stacked contacts
- Ambient conditions:
 - Operating temperature: -25...+70°C
 - Storage temperature: -40...+85°C
- Degree of protection: IP20.

Mounting adapter

See page 7-36.

The mounting adapter directly snaps onto the actuator fixed to the mounting surface.

General characteristics

- Rated frequency: 50-60Hz
- Auxiliary supply voltage:
 - 12...30VAC/DC; 85...140VAC; 185...265VAC
- Maximum consumption: 17mA-0.50W (12...30VAC/DC); 20mA-0.40W (85...140VAC); 18mA-0.55W (185...265VAC)
- Total protection:
 - Against overvoltages
 - Against stray currents in wiring
 - To reduce flickering phenomenon
 - To withstand vibrations
- Minimum activation voltage:
 - 4V-1mA (12...30VAC/DC); 30V-4mA (85...140VAC); 55V-4mA (185...265VAC)
- Electrical life: 100,000 hours.

Wiring diagram for LED elements



Maximum conductor cross section

1 or 2 2.5mm² or AWG14 cables. For 2.5mm² section, use rounded cable terminal with metal end at least 10mm.

Certifications and compliance

Certifications obtained: UL Listed for USA and Canada, (cULus - File E93601), as Auxiliary Devices; EAC, CCC, RINA. Compliant with standards: IEC/EN/BS 60947-1, IEC/EN/BS 60947-5-1, UL508, CSA C22.2 n° 14.

LED elements, steady light base mount on LPZP... control stations with screw terminals



LPXLPB...

Total protection against overvoltages and stray currents in wiring, to reduce flickering phenomenon and withstand vibrations.

Order code	Rated supply voltage	LED color	Qty per pkg.	Wt
	[V]		n°	[kg]

Screw termination.
Steady light.

Direct snap-on mounting on LPZ... control station base.

LPXLPBB3	12...30V AC/DC	Green	10	0.016
LPXLPBB4		Red	10	0.016
LPXLPBB5		Yellow	10	0.016
LPXLPBB6		Blue	10	0.016
LPXLPBB8		White	10	0.016
LPXLPBE3	85...140V AC	Green	10	0.016
LPXLPBE4		Red	10	0.016
LPXLPBE5		Yellow	10	0.016
LPXLPBE6		Blue	10	0.016
LPXLPBE8		White	10	0.016
LPXLPBM3	185...265V AC	Green	10	0.016
LPXLPBM4		Red	10	0.016
LPXLPBM5		Yellow	10	0.016
LPXLPBM6		Blue	10	0.016
LPXLPBM8		White	10	0.016

Mounting position on the LPZ... control station base

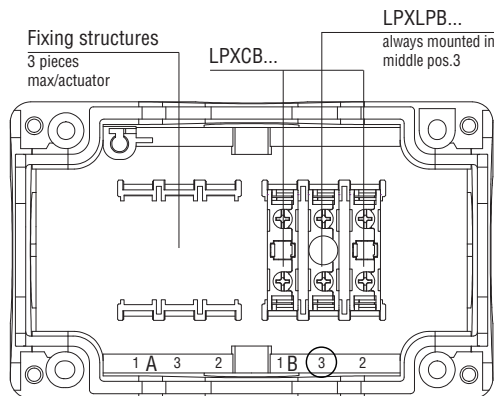

Operational characteristics

- Any mounting position allowed
- Snap-on mounting into fixing structures of LPZ... control station base (in middle pos. 3) for each actuator
- See the combinations given under "Contact elements" in the right-hand column for each type of pushbutton and selector switch
- For use with test elements, consult Technical support; see contact details on inside front cover
- Maximum tightening torque for screw terminals: 1Nm/8.8lb.in
- Ambient conditions:
 - Operating temperature: -25...+70°C
 - Storage temperature: -40...+85°C
- Degree of protection: IP20.

General characteristics

- Rated frequency: 50...60Hz
- Auxiliary supply voltage: 12...30VAC/DC; 85...140VAC; 185...265VAC
- Maximum consumption: 17mA-0.50W (12...30VAC/DC); 20mA-0.40W (85...140VAC); 18mA-0.55W (185...265VAC)
- Total protection:
 - Against overvoltages
 - Against stray currents in wiring
 - To reduce flickering phenomenon
 - To withstand vibrations
- Minimum activation voltage:
 - steady light LPXLPB.....: 4V-1mA (12...30VAC/DC); 30V-4mA (85...140VAC); 55V-4mA (185...265VAC)
- Electrical life: 100,000 hours.

Wiring diagram for LED elements



Maximum conductor cross section

1 or 2 2.5mm² or AWG14 cables.

Certifications and compliance

Certifications obtained: UL Listed for USA and Canada, (cULus - File E93601), as Auxiliary Devices; EAC, CCC, RINA. Compliant with standards: IEC/EN/BS 60947-1, IEC/EN/BS 60947-5-1, UL508, CSA C22.2 n° 14.

Accessories and spare parts for Ø22mm metal LPS... actuators



LPSXB0

new



LPXA162M



LPXA130



LPXA130B



LPXDIN



LPXAU138



LPXAU158



LPXAU159

new



LPXA185



LPXAU170



LPXAU100

LPXAU105

LPXAU108
LPXAU109

Order code	Description	Qty	Wt
		pkg	[kg]
		n°	
LPSXB0❶	Flush or extended spring return actuator with no cap	5	0.013
LPSXB3❶	Shrouded spring return actuator with no cap	5	0.014
LPSXQ0❶	Flush or extended push-push actuator with no cap	5	0.013
LPSXQL0❶	Illuminated flush or extended push-push actuator with no lens	5	0.013
LPXA161M	Adapter for Ø30mm/1.18" holes to Ø22mm/0.87" for mushroom operators	5	0.030
LPXA162M	Adapter for Ø30mm/1.18" holes to Ø22mm/0.87" for pushbuttons and selector switches	5	0.032
LPSXA127	Transparent diffuser for double-touch buttons	5	0.001
LPXA130	Threaded plug for unused drilled holes (grey)	10	0.007
LPXA130B	Threaded plug for unused drilled holes (black)	10	0.007
LPXDIN	Adapter for mounting buttons on DIN rail 35mm/1.38" wide (2 modules)	10	0.008
LPXA150	Rod for mechanical reset button (l=150mm/5.90")	10	0.006
Protections.			
LPXAU138❶❷	Rubber boot for flush buttons	10	0.006
LPXAU148❶❷	Rubber boot for extended buttons	10	0.009
LPXAU157	Rubber boot for double and triple-touch buttons (transpar.)	10	0.007
LPXAU167❶❷❸	Rubber boot for mushroom head buttons, LPSB63/B66/B67/BL66... (transparent)	10	0.012
LPXAU158❶❷❸	Padlockable protection, Ø5-8mm/0.2-0.31" locks for buttons LPSB66/B67/B68/BL664...; for LSCB634... Ø5-6mm/0.2-0.24" locks only	10	0.005
LPXAU159❶❷❸	Shroud for buttons LPB63/66/67/68/BL666...	10	0.010
LPXAU170	Protection cover for Ø22mm metal buttons	5	0.015
LPXAU171	Coperchio di protezione con chiusura a molle per pulsanti metallici Ø22mm	5	0.016
LPXA185	Yellow shroud for selectors	10	0.004
Label holders and labels. ❹			
LPXAU100	Label holder for LPXAU109 and LPXAU203 labels	50	0.001
LPXAU203	Blank label for writing	50	0.001
LPXAU109	Engraving silver plastic label to use with LPXAU100 holder	50	0.002
LPXAU105	Label holder for LPXAU108 plastic labels	50	0.003
LPXAU108	Engraving silver plastic label to use with LPXAU105 holder	50	0.002
LPXAU102❺	Legend holder for LPXAU202 paper or LPXAU201 plastic labels	50	0.003
LPXAU202	Blank paper label for writing for LPXAU102	50	0.002
LPXAU200	Transparent protection for LPXAU202 label	50	0.001
LPXAU201	Blank plastic label for engraving for LPXAU102	50	0.002

General characteristics

LABEL DIMENSIONS

- LPXAU108: 26.5x15mm/1.04x0.59"
- LPXAU109: 27.5x12.1mm/1.08x0.48"
- LPXAU202: 27.5x15.1mm/1.08x0.59"
- LPXAU201: 27.5x15.1mm/1.08x0.59"
- LPXAU203: 27.5x12.1mm/1.08x0.48"

- ❶ For actuators caps and lenses see page 7-47.
- ❷ The use of the LPXAU102 label holder with LPS... actuators does not guarantee the IP65 degree of protection.
- ❸ For flush and extended push buttons, complete the order code by adding the digit of the required colour:
2 (black); 3 (green); 4 (red); 5 (yellow); 6 (blue); 7 (transparent); 8 (white).
For illuminated push buttons, add only digit 7 (transparent).
- ❹ Cannot be used when LPXAU100, LPXAU105 or LPXAU102 is fitted.
- ❺ Cannot be used when LPXAU158 is fitted.
- ❻ Cannot be used when LPXAU167 is fitted.
- ❼ For labels with text see page 7-48.

Accessories and spare parts for Ø30mm flat metal LPF... actuators



LPFXB0

new



LPXAU00



LPFXAU100



LPFXAU105



LPFXAU100G



LPFXAU105G

Order code	Description	Qty pkg	Wt
		n°	[kg]
LPFXB0	Flush or extended spring return actuator with no cap	5	0.013
LPFXQ0	Flush or extended push-push actuator with no cap	5	0.013
LPFXQL0	Illuminated flush or extended push-push actuator with no cap	5	0.013
LPFXAU00	Metal adapter for actuator fixing	5	0.002
LPFXA130	Threaded plug for unused drilled holes (black)	5	0.007
Label holders and labels. 2			
LPFXAU100	Label holder for LPXAU109 and LPXAU203 labels (black)	5	0.004
LPFXAU100G	Label holder for LPXAU109 and LPXAU203 labels (grey)	5	0.004
LPXAU203	Blank label for writing	50	0.001
LPFXAU105	Label holder for LPXAU108 plastic labels (black)	5	0.005
LPFXAU105G	Label holder for LPXAU108 plastic labels (grey)	5	0.005
LPXAU109	Engravable silver plastic label to use with LPXAU100 holder	50	0.002
LPXAU108	Engravable silver plastic label to use with LPXAU105 holder	50	0.002

General characteristics

LABEL DIMENSIONS

- LPXAU108: 26.5x15mm/1.04x0.59"
- LPXAU109: 27.5x12.1mm/1.08x0.48"
- LPXAU202: 27.5x15.1mm/1.08x0.59"
- LPXAU201: 27.5x15.1mm/1.08x0.59"
- LPXAU203: 27.5x12.1mm/1.08x0.48"

- 1** For actuators caps and lenses see page 7-47.
- 2** For labels with text see page 7-48.

Accessories and spare parts for Ø22mm chromed plastic LPC... actuators

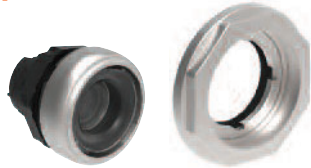

LPXB0 LPXA162



LPXA200



LPXAU00 LPXAU01



LPXA130 LPXA130B



LPXDIN



LPXAU138 LPXAU158



LPXAU159



LPXA185



LPXAU170 LPXAU171



LPXAU100 LPXAU105 LPXAU108 LPXAU109

new

new

Order code	Description	Qty pkg	Wt [kg]
LPXB0	Flush or extended spring return actuator with no cap	10	0.013
LPXB3	Shrouded spring return actuator with no cap	10	0.014
LPXQ0	Flush or extended push-push actuator with no cap	10	0.013
LPXQL0	Illuminated flush or extended push-push actuator with no lens	10	0.013
LPXA161	Adapter for Ø30mm/1.18" holes to Ø22mm/0.87" for mushroom operators	5	0.018
LPXA162	Adapter for Ø30mm/1.18" holes to Ø22mm/0.87" for push-buttons and selector switches	5	0.018
LPXA200	Socket spanner/wrench for fixing ring fitting	1	0.003
LPXA127	Transparent diffuser for double-touch buttons	10	0.001
LPXAU00	Plastic threaded ring for actuator fixing	20	0.002
LPXAU01	Metallic threaded ring for actuator fixing	20	0.015
LPXA130	Threaded plug for unused drilled holes (grey)	10	0.007
LPXA130B	Threaded plug for unused drilled holes (black)	10	0.007
LPXDIN	Adapter for mounting buttons on DIN rail 35mm/1.38" wide (2 modules)	10	0.008
LPXA150	Rod for mechanical reset button (l=150mm/5.90")	10	0.006

Protections.

LPXAU13	Rubber boot for flush buttons	10	0.006
LPXAU14	Rubber boot for extended buttons	10	0.009
LPXAU157	Rubber boot for double and triple-touch buttons (transpar.)	10	0.007
LPXAU167	Rubber boot for mushroom head buttons, LPCB63/B66/B67/BL66... (transparent)	10	0.012
LPXAU158	Padlockable protection, Ø5-8mm/0.2-0.31" locks for buttons LPCB66/B67/B68/BL664...; for LPCB634... Ø5-6mm/0.2-0.24" locks only	10	0.005
LPXAU159	Shroud for buttons LPCB63/66/67/68/BL666...	10	0.010
LPXA185	Yellow shroud for selectors	10	0.004
LPXAU170	Protection cover for Ø22mm/0.87" plastic buttons	5	0.015
LPXAU171	Protection cover for Ø22mm/0.87" communication interfaces	5	0.018

Label holders and labels. 7

LPXAU100	Label holder for LPXAU109 and LPXAU203 labels	50	0.001
LPXAU203	Blank label for writing	50	0.001
LPXAU109	Engravable silver plastic label to use with LPXAU100 holder	50	0.002
LPXAU105	Label holder for LPXAU108 plastic labels	50	0.003
LPXAU108	Engravable silver plastic label to use with LPXAU105 holder	50	0.002
LPXAU102	Legend holder for LPXAU202 paper or LPXAU201 plastic labels	50	0.003
LPXAU202	Blank paper label for writing for LPXAU102	50	0.002
LPXAU200	Transparent protection for LPXAU202 label	50	0.001
LPXAU201	Blank plastic label for engraving for LPXAU102	50	0.002

General characteristics

LABEL DIMENSIONS

- LPXAU108: 26.5x15mm/1.04x0.59"
- LPXAU109: 27.5x12.1mm/1.08x0.48"
- LPXAU202: 27.5x15.1mm/1.08x0.59"
- LPXAU201: 27.5x15.1mm/1.08x0.59"
- LPXAU203: 27.5x12.1mm/1.08x0.48"

- For actuators caps and lenses see page 7-47.
- The use of the LPXAU102 label holder with LPC... actuators does not guarantee the IP65 degree of protection.
- For flush and extended push buttons, complete the order code by adding the digit of the required colour: 2 (black); 3 (green); 4 (red); 5 (yellow); 6 (blue); 7 (transparent); 8 (white). For illuminated push buttons, add only digit 7 (transparent).
- Cannot be used when LPXAU100, LPXAU105 or LPXAU102 is fitted.
- Cannot be used when LPXAU158 is fitted.
- Cannot be used when LPXAU167 is fitted.
- For labels with text see page 7-48.

Accessories and spare parts for Ø30mm flat metal actuators, Ø22mm metal and chromed plastic actuators



LPXA140



LPXA170...



LPXB104



LPXBL105



LPXB203



LPXBL206

Order code	Description	Qty per pkg	Wt
		n°	[kg]
LPXA140	Action plug for centre contact	50	0.001
LPXA170	Spare standard key set for selector switches or mushroom-head buttons, key code n° 455	10	0.008
LPX A170R①	Spare key set for selector switches or mushroom head buttons	1	0.008

Flush cap for spring return and push-push actuators.

LPXB102	Black	10	0.002
LPXB103	Green	10	0.002
LPXB104	Red	10	0.002
LPXB105	Yellow	10	0.002
LPXB106	Blue	10	0.002
LPXB108	White	10	0.002

Extended cap for spring return and push-push actuators.

LPXB202	Black	10	0.003
LPXB203	Green	10	0.003
LPXB204	Red	10	0.003
LPXB205	Yellow	10	0.003
LPXB206	Blue	10	0.003
LPXB208	White	10	0.003

Flush lens for illuminated spring return and push-push actuators.

LPXBL103	Green	10	0.002
LPXBL104	Red	10	0.002
LPXBL105	Yellow	10	0.002
LPXBL106	Blue	10	0.002
LPXBL107	Transparent	10	0.002

Extended lens for illuminated spring return and push-push actuators.

LPXBL203	Green	10	0.003
LPXBL204	Red	10	0.003
LPXBL205	Yellow	10	0.003
LPXBL206	Blue	10	0.003
LPXBL207	Transparent	10	0.003

① Versions with different key code. Complete with the numeric code of the key. The following versions are available: 421E, 458A, 520E, 3131A, 3433E
Example of complete code: LPXA170R421E.

Labels with text for LPXAU100 and LPFXAU100... legend holders

START

LPXAGB220

STOP

LPXAGB221

AUTO - MAN

LPXAGB212

STOP-START

LPXAGB211

I - II

LPXAGB204

Order code	Text	Qty per pkg n°	Wt [kg]
International labels for pushbuttons and selector switches.			
LPXAGB200	O	50	0.001
LPXAGB201	I	50	0.001
LPXAGB202	II	50	0.001
LPXAGB203	O-I	50	0.001
LPXAGB204	I-II	50	0.001
LPXAGB205	I-O-II	50	0.001
Labels for selector switches.			
LPXAGB210	OFF-ON	50	0.001
LPXAGB211	STOP-START	50	0.001
LPXAE211	PAR-MAR	50	0.001
LPXAGB212	AUTO-MAN	50	0.001
LPXAGB213	MAN-AUTO	50	0.001
LPXAGB214	AUTO-O-MAN	50	0.001
LPXAGB215	MAN-O-AUTO	50	0.001
LPXAGB216	REV-O-FWD	50	0.001
LPXAI216	AV.-O-IND.	50	0.001
Labels for general use.			
LPXAGB220	START	50	0.001
LPXAI220	MARCIA	50	0.001
LPXAE220	MARCHA	50	0.001
LPXAGB221	STOP	50	0.001
LPXAI221	ARRESTO	50	0.001
LPXAE221	PARADA	50	0.001
LPXAGB222	RESET	50	0.001
LPXAE222	REARME	50	0.001
LPXAGB223	EMERGENCY	50	0.001
LPXAI223	EMERGENZA	50	0.001
LPXAE223	EMERGENCIA	50	0.001
LPXAGB224	ON	50	0.001
LPXAI224	IN SERVIZIO	50	0.001
LPXAE224	EN SERVICIO	50	0.001
LPXAGB225	POWER ON	50	0.001
LPXAI225	PRESENZA TENSIONE	50	0.001
LPXAGB226	OFF	50	0.001
LPXAGB227	FORWARD	50	0.001
LPXAI227	AVANTI	50	0.001
LPXAGB228	REVERSE	50	0.001
LPXAI228	INDIETRO	50	0.001
LPXAGB229	OPEN	50	0.001
LPXAI229	APERTURA	50	0.001
LPXAGB230	CLOSE	50	0.001
LPXAI230	CHIUSURA	50	0.001
LPXAGB231	RAISE	50	0.001
LPXAI231	SALITA	50	0.001
LPXAE231	SUBIDA	50	0.001
LPXAGB232	LOWER	50	0.001
LPXAI232	DISCESA	50	0.001
LPXAE232	BAJADA	50	0.001
LPXAI233	INTERVENTO TERMICO	50	0.001
LPXAGB234	FAULT	50	0.001
LPXAI235	DISINSERITO	50	0.001
LPXAGB236	LOCK	50	0.001
LPXAGB237	LEFT	50	0.001
LPXAGB238	MAN-AUTO	50	0.001

General characteristics

The labels have indelible scratch-proof black lettering on metalised grey polycarbonate background (adhesive). All LPXA...2... labels have the following dimensions: 27.5x12.1mm/1.08x0.48".

Special versions

Labels in different languages are available. Consult Technical support; see contact details on inside front cover.

Plastic disk for Ø22mm mushroom head pushbuttons



LPXAU113



LPXAU114



LPXAU124



LPXAU110

new

Order code	Text	Qty per pkg	Wt
		n°	[kg]
LPXAU112	EMERGENZA ARRESTO Ø90mm/3.5"	10	0.005
LPXAU114	EMERGENZA ARRESTO Ø60mm/2.4"	10	0.003
LPXAU113	EMERGENCY STOP Ø90mm/3.5"	10	0.005
LPXAU115	EMERGENCY STOP Ø60mm/2.4"	10	0.003
LPXAU124	IEC60417-5638 symbol according to ISO 13850 Ø90mm/3.5"	10	0.005
LPXAU123	IEC60417-5638 symbol according to ISO 13850 Ø60mm/2.4"	10	0.005
LPXAU110	Adhesive label EMERGENCY STOP (34.5x65mm/1.36x2.56") for LP...B63/663/664/67/68/BL66... buttons	10	0.001
LPXAU118	ARRET D'URGENCE / NOT-AUS / PARO EMERGENCIA Ø60mm/2.4"	10	0.003

General characteristics

The disks are made of non-adhesive plastic. Plastic disks cannot be used with LPXAU158 and LPXAU159 protection.

Ø60mm illuminated plastic disk for Ø22mm mushroom head pushbuttons



LPXDAU1140...

new

Order code	Text	Qty per pkg	Wt
		n°	[kg]
24VAC/DC auxiliary supply.			
LPXDAU114024	EMERGENZA ARRESTO	1	0.100
LPXDAU115024	EMERGENCY STOP	1	0.100
LPXDAU118024	ARRET D'URGENCE / NOT AUS / PARO EMERGENCIA	1	0.100
LPXDAU123024	IEC60417-5638 symbol according to ISO 13850	1	0.100
110...120VAC auxiliary supply.			
LPXDAU114110	EMERGENZA ARRESTO	1	0.100
LPXDAU115110	EMERGENCY STOP	1	0.100
LPXDAU118110	ARRET D'URGENCE / NOT AUS / PARO EMERGENCIA	1	0.100
LPXDAU123110	IEC60417-5638 symbol according to ISO 13850	1	0.100
220...240VAC auxiliary supply.			
LPXDAU114230	EMERGENZA ARRESTO	1	0.100
LPXDAU115230	EMERGENCY STOP	1	0.100
LPXDAU118230	ARRET D'URGENCE / NOT AUS / PARO EMERGENCIA	1	0.100
LPXDAU123230	IEC60417-5638 symbol according to ISO 13850	1	0.100

General characteristics

The main function of the illuminated plastic disk is to make the emergency button more identifiable by ensuring its operation in conditions of low visibility. The illuminated plastic disks integrate two light functions: steady or flashing. The function choice depends on the wiring.

Operational characteristics

- Auxiliary supply voltage: 24VAC/DC, 110...120VAC or 220...240VAC
- Rated frequency: 50/60Hz
- Electrical life: >30,000 hours
- Ambient conditions:
 - Operating temperature: -25...+70°C
 - Storage temperature: -40...+85°C
- Degree of protection:
 - Per IEC/EN: IP66, IP67 and IP69K
 - Per UL: Type 1, 2, 3R, 4, 4X, 12, 12K.

Certifications and compliance

Certifications: cULus
Compliant with standards: IEC/EN/BS 60947-1, IEC/EN/BS 60947-5-1, UL508, CSA C22.2 n°14

COMBINATIONS FOR ILLUMINATED PUSHBUTTONS AND SELECTOR SWITCHES

SPRING RETURN BUTTONS

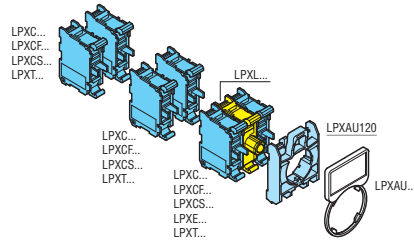
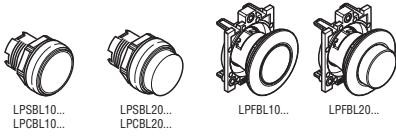

PUSH-PUSH BUTTONS

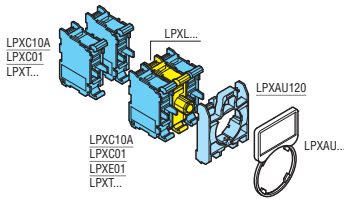
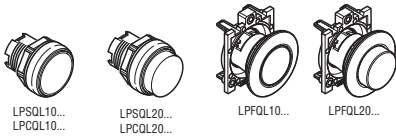

MUSHROOM-HEAD SPRING RETURN BUTTON

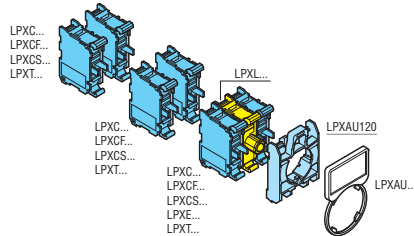

MUSHROOM-HEAD LATCH BUTTON

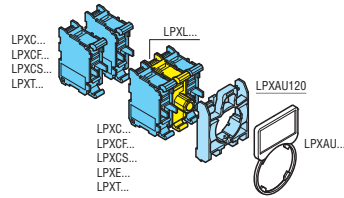

DOUBLE-TOUCH BUTTONS

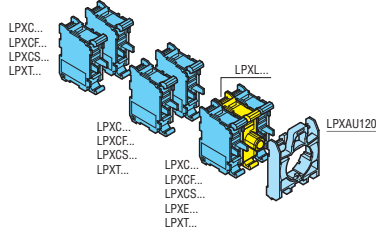

2 AND 3 POSITION SELECTOR SWITCHES

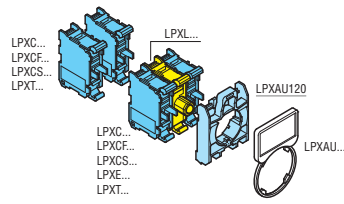
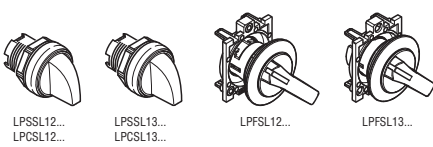

Without actuators



LPZP1A5

new



LPZP1A5P

new



LPZP1A8P



LPZP2A5

LPZP3A8

Anti-loosening action
Anti-rotation indents to extend
fixing ring gripping over time

Order code	Description	Cover colour	Qty per pkg	Wt
			n°	[kg]
LPZP1A5	For 1 actuator	Yellow	1	0.107
LPZP1A5P	For 1 actuator with shroud	Yellow	1	0.127
LPZP1A8	For 1 actuator	Grey	1	0.107
LPZP1A8P	For 1 actuator with shroud	Grey	1	0.127
LPZP2A5	For 2 actuators	Yellow	1	0.152
LPZP2A8	For 2 actuators	Grey	1	0.152
LPZP3A8	For 3 actuators	Grey	1	0.187
LPZP4A8	For 4 actuators	Grey	1	0.200
LPZP5A8	For 5 actuators	Grey	1	0.240
LPZP6A8	For 6 actuators	Grey	1	0.290

Control station base

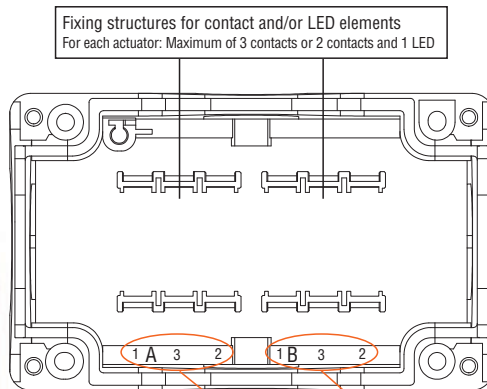

Control station cover (inside view)

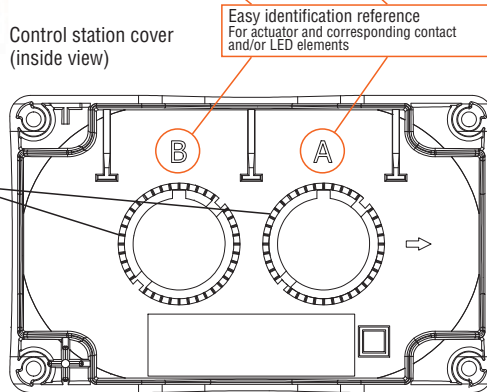

General characteristics

CONTROL STATIONS WITHOUT ACTUATOR

- 1 to 6 holes
- Compact dimensions
- Easy wiring for base-mount contact and LED elements; possible use of screw and spring-clamp terminal contact or LED elements on the inside surface of the cover using mounting adapter
- Numerous cable entries.

Operational characteristics

- Cable entry:
 - LPZP1... knockouts:
 - M16/PG11 (1 at rear and 1 on left side)
 - M20/M25/PG13.5/PG16 (1 each on top and bottom)
 - LPZP2... knockouts:
 - M16/PG11 (2 at rear)
 - M20/PG13.5 (1 on each side)
 - M20/M25/PG13.5/PG16 (1 each on top and bottom)
 - LPZP3/P4/P5/P6 A8 knockouts:
 - M16/PG11 (2 at rear)
 - M20/PG13.5 (2 on each side)
 - M20/M25/PG13.5/PG16 (1 each on top and bottom)
- Any mounting position allowed
- Tightening torque of cover screws $T_{max} = 1.8Nm/16lb.in$
- Ambient conditions:
 - Operating temperature: $-25...+70^{\circ}C$
 - Storage temperature: $-40...+85^{\circ}C$
- Degree of protection:
 - Per IEC/EN: IP66, IP67 and IP69K
 - Per UL: Type 1, 2, 3R, 4, 4X, 12K.

Materials

Polycarbonate.

Certifications and compliance

Certifications obtained: UL Listed for USA and Canada, (cULus - File E93601), as Auxiliary Devices; EAC, CCC, RINA. Compliant with standards: IEC/EN/BS 60947-1, IEC/EN/BS 60947-5-1, UL508A for types without actuators / UL508 for types complete with actuator, CSA C22.2 n° 14.

Accessories



LPZXP5

new



LPZXP8



LPXP01

Order code	Description	Qty per pkg	Wt
		n°	[kg]
LPZXP5	4-piece set yellow screw protection caps	1	0.004
LPZXP8	4-piece set grey screw protection caps	1	0.004
LPXP01	M20 cable gland for LPZP... control stations	50	0.012

With 1 actuator

new



LPZP1B8100



LPZP1B8101



LPZP1B8102



LPZP1B8103



LPZP1B8104



LPZP1B8105

new



LPZP1B8300



LPZP1B8301



LPZP1B8302



LPZP1B8303

Order code	Description	Contacts config.	Qty per pkg	Wt
			n°	[kg]

Grey control station.

LPZP1B8100	Green spring return flush pushbutton with "I" symbol	1NO	1	0.145
LPZP1B8101	Green spring return flush pushbutton with "START" symbol	1NO	1	0.145
LPZP1B8102	Red spring return flush pushbutton with "0" symbol	1NC	1	0.145
LPZP1B8103	Red spring return flush pushbutton with "STOP" symbol	1NC	1	0.145
LPZP1B8104	Red spring return extended pushbutton with "0" symbol	1NC	1	0.146
LPZP1B8105	Red spring return extended pushbutton with "STOP" symbol	1NC	1	0.147

Order code	Description	Contacts config.	Qty per pkg	Wt
			n°	[kg]

Grey control station.

LPZP1B8300	Selector switch lever, 2 position with label "0-I"	1NO	1	0.150
LPZP1B8301	Selector switch key, 2 position with label "0-I"	1NO	1	0.179
LPZP1B8302	Selector switch key, 2 position with label "0-I"	1NO+1NC	1	0.189
LPZP1B8303	Selector switch lever, 3 position with label "I-0-II"	2NO	1	0.160

General characteristics

- Compact dimensions
- Easy wiring
- Numerous cable entries
- Contact elements base-mount on control station.

Operational characteristics

- Cable entry knockouts:
 - M16/PG11 (1 at rear and 1 on left side)
 - M20/M25/PG13.5/PG16 (1 each on top and bottom)
- Any mounting position allowed
- Tightening torque of cover screws $T_{max} = 1.8Nm/16lb.in$
- Ambient conditions:
 - Operating temperature: $-25...+70^{\circ}C$
 - Storage temperature: $-40...+85^{\circ}C$
- Degree of protection:
 - Per IEC/EN: IP66, IP67 and IP69K
 - Per UL: Type 1, 2, 3R, 4, 4X, 12K.

Materials

Polycarbonate.

Certifications and compliance

Certifications obtained: cULus, EAC, CCC, RINA.
Compliant with standards: IEC/EN/BS 60947-1, IEC/EN/BS 60947-5-1, UL508A, CSA C22.2 n° 14.

7

With 1 actuator

new



LPZP1B5600

LPZP1B5601



LPZP1B5602

LPZP1B5603



LPZP1B5604

LPZP1B5605



LPZP1B5606

LPZP1B5607

Order code	Description	Contacts config.	Qty per pkg	Wt
			n°	[kg]
Yellow control station.				
LPZP1B5600	Mushroom head pushbutton, latch, turn to release for emergency stopping, ISO 13850 with plastic disk EMERGENCY/STOP	1NC	1	0.176
LPZP1B5601	Mushroom head pushbutton, latch, turn to release for emergency stopping, ISO 13850	2NC	1	0.183
LPZP1B5602	Mushroom head pushbutton, latch, turn to release for normal stopping	1NC	1	0.179
LPZP1B5603	Mushroom head pushbutton, latch, turn to release for emergency stopping, ISO 13850	1NC	1	0.173
LPZP1B5604	Mushroom head pushbutton, latch, turn to release for emergency stopping, ISO 13850	1NO+1NC	1	0.183
LPZP1B5605	Mushroom head pushbutton, latch, turn key to release for emergency stopping, ISO 13850 with plastic disk EMERGENCY/STOP	1NC	1	0.198
LPZP1B5606	Mushroom head pushbutton, latch, turn key to release for emergency stopping, ISO 13850	2NC	1	0.205
LPZP1B5607	Mushroom head pushbutton, latch, turn key to release for emergency stopping, ISO 13850	1NO+1NC	1	0.205

❶ Not included in cULus homologation.

General characteristics

- Compact dimensions
- Easy wiring
- Numerous cable entries
- Contact elements base-mount on control station.

Operational characteristics

- Cable entry knockouts:
 - M16/PG11 (1 at rear and 1 on left side)
 - M20/M25/PG13.5/PG16 (1 each on top and bottom)
- Any mounting position allowed
- Tightening torque of cover screws T_{max} = 1.8Nm/16lb.in
- Ambient conditions:
 - Operating temperature: -25...+70°C
 - Storage temperature: -40...+85°C
- Degree of protection:
 - Per IEC/EN: IP66, IP67 and IP69K
 - Per UL: Type 1, 2, 3R, 4, 4X, 12K.

Materials

Polycarbonate.

Certifications and compliance

Certifications obtained: cULus, EAC, CCC, RINA.
Compliant with standards: IEC/EN/BS 60947-1, IEC/EN/BS 60947-5-1, UL508A, CSA C22.2 n° 14.

new



LPZP1B5608



LPZP1B5609



LPZP1B5610



LPZP1B5612



LPZP1B5P603



LPZP1B5611

new

Order code	Description	Contacts config.	Qty per pkg	Wt [kg]
------------	-------------	------------------	-------------	---------

Yellow control station.

LPZP1B5608 ①	Mushroom head pushbutton, latch, pull to release for emergency stopping, ISO 13850 with plastic disk EMERGENCY/STOP	1NC	1	0.176
LPZP1B5609 ①	Mushroom head pushbutton, latch, pull to release for emergency stopping, ISO 13850	2NC	1	0.183
LPZP1B5610 ①	Mushroom head pushbutton, latch, pull to release for emergency stopping, ISO 13850	1NO+1NC	1	0.183
LPZP1B5612	Mushroom head pushbutton, latch, turn to release for normal stopping with label "STOP"	1NC	1	0.180

Yellow control station with protection.

LPZP1B5P603	Mushroom head pushbutton, latch, turn to release for emergency stopping, ISO 13850	1NC	1	0.176
LPZP1B5611 ①	Mushroom head pushbutton, latch, pull to release for emergency stopping, ISO 13850 with padlockable protection	1NC	1	0.178

① Not included in cULus homologation.

General characteristics

- Compact dimensions
- Easy wiring
- Numerous cable entries
- Contact elements base-mount on control station.

Operational characteristics

- Cable entry knockouts:
 - M16/PG11 (1 at rear and 1 on left side)
 - M20/M25/PG13.5/PG16 (1 each on top and bottom)
- Any mounting position allowed
- Tightening torque of cover screws $T_{max} = 1.8Nm/16lb.in$
- Ambient conditions:
 - Operating temperature: $-25...+70^{\circ}C$
 - Storage temperature: $-40...+85^{\circ}C$
- Degree of protection:
 - Per IEC/EN: IP66, IP67 and IP69K
 - Per UL: Type 1, 2, 3R, 4, 4X, 12K.

Materials

Polycarbonate.

Certifications and compliance

Certifications obtained: cULus, EAC, CCC, RINA.
Compliant with standards: IEC/EN/BS 60947-1, IEC/EN/BS 60947-5-1, UL508A, CSA C22.2 n° 14.

7 Pushbuttons and selector switches

Plastic complete control stations **PLatinum** series

With 2 actuators

new



LPZP2B8900

LPZP2B8901



LPZP2B8902

LPZP2B8903



LPZP2B8904

LPZP2B5905

Order code	Description	Contacts config.	Qty per pkg	Wt
			n°	[kg]
Grey control station.				
LPZP2B8900	Green spring return flush pushbutton with "I" symbol	1NO	1	0.213
	Red spring return flush pushbutton with "O" symbol	1NC	1	
LPZP2B8901	Green spring return flush pushbutton with "I" symbol	1NO	1	0.214
	Red spring return extended pushbutton with "O" symbol	1NC	1	
LPZP2B8902	White spring return flush pushbutton with "up arrow" symbol	1NO	1	0.213
	Black spring return flush pushbutton with "down arrow" symbol	1NO	1	
LPZP2B8903	White spring return flush pushbutton with "right arrow" symbol	1NO	1	0.214
	Black spring return flush pushbutton with "left arrow" symbol	1NO	1	
LPZP2B8904	Green spring return flush pushbutton with "I" symbol	1NO	1	0.240
	Mushroom head pushbutton, latch, turn to release for emergency stopping, ISO 13850	1NC	1	
Yellow control station.				
LPZP2B5905	Mushroom head pushbutton, latch, turn key to release for emergency stopping, ISO 13850	1NO+1NC	1	0.272
	Red steady pilot light 12...30VAC/DC	–	1	

General characteristics

- Compact dimensions
- Easy wiring
- Numerous cable entries
- Contact elements and LED elements, base-mount on control station.

Operational characteristics

- Cable entry knockouts:
 - M16/PG11 (2 at rear)
 - M20/PG13.5 (1 on each side)
 - M20/M25/PG13.5/PG16 (1 each on top and bottom)
- Any mounting position allowed
- Tightening torque of cover screws T_{max} = 1.8Nm/16lb.in
- Ambient conditions:
 - Operating temperature: -25...+70°C
 - Storage temperature: -40...+85°C
- Degree of protection:
 - Per IEC/EN: IP66, IP67 and IP69K
 - Per UL: Type 1, 2, 3R, 4, 4X, 12K.

Materials

Polycarbonate.

Certifications and compliance

Certifications obtained: cULus, EAC, CCC, RINA.
 Compliant with standards: IEC/EN/BS 60947-1, IEC/EN/BS 60947-5-1, UL508A, CSA C22.2 n° 14.

With 3 actuators

new



LPZP3B8900

LPZP3B8901



LPZP3B8902

LPZP3B8903



LPZP3B8904

LPZP3B8905



LPZP3B8906

LPZP3B8907

Order code	Description	Contacts config.	Qty per pkg	Wt
			n°	[kg]
Grey control station.				
LPZP3B8900	Green spring return flush pushbutton with "I" symbol	1NO	1	0.270
	Red spring return flush pushbutton with "O" symbol	1NC	1	
	Red steady pilot light 12...30VAC/DC	-	1	
LPZP3B8901	Green spring return flush pushbutton with "I" symbol	1NO	1	0.271
	Red spring return extended pushbutton with "O" symbol	1NC	1	
	Red steady pilot light 12...30VAC/DC	-	1	
LPZP3B8902	Green spring return flush pushbutton with "I" symbol	1NO	1	0.270
	Red spring return flush pushbutton with "O" symbol	1NC	1	
	Green spring return flush pushbutton with "II" symbol	1NO	1	
LPZP3B8903	Green spring return flush pushbutton with "I" symbol	1NO	1	0.271
	Red spring return extended pushbutton with "O" symbol	1NC	1	
	Green spring return flush pushbutton with "II" symbol	1NO	1	
LPZP3B8904	White spring return flush pushbutton with "I" symbol	1NO	1	0.270
	Red spring return flush pushbutton with "O" symbol	1NC	1	
	White spring return flush pushbutton with "II" symbol	1NO	1	
LPZP3B8905	White spring return flush pushbutton with "I" symbol	1NO	1	0.271
	Red spring return extended pushbutton with "O" symbol	1NC	1	
	White spring return flush pushbutton with "II" symbol	1NO	1	
LPZP3B8906	White spring return flush pushbutton with "up arrow" symbol	1NO	1	0.270
	Red spring return flush pushbutton with "O" symbol	1NC	1	
	Black spring return flush pushbutton with "down arrow" symbol	1NO	1	
LPZP3B8907	White spring return flush pushbutton with "up arrow" symbol	1NO	1	0.271
	Red spring return extended pushbutton with "O" symbol	1NC	1	
	Black spring return flush pushbutton with "down arrow" symbol	1NO	1	

General characteristics

- Compact dimensions
- Easy wiring
- Numerous cable entries
- Contact elements and LED elements, base-mount on control station.

Operational characteristics

- Cable entry knockouts:
 - M16/PG11 (2 at rear)
 - M20/PG13.5 (2 on each side)
 - M20/M25/PG13.5/PG16 (1 each on top and bottom)
- Any mounting position allowed
- Tightening torque of cover screws Tmax = 1.8Nm/16lb.in
- Ambient conditions:
 - Operating temperature: -25...+70°C
 - Storage temperature: -40...+85°C
- Degree of protection:
 - Per IEC/EN: IP66, IP67 and IP69K
 - Per UL: Type 1, 2, 3R, 4, 4X, 12K.

Materials

Polycarbonate.

Certifications and compliance

Certifications obtained: cULus, EAC, CCC, RINA.
 Compliant with standards: IEC/EN/BS 60947-1, IEC/EN/BS 60947-5-1, UL508A, CSA C22.2 n° 14.

7 Pushbuttons and selector switches

Plastic complete control stations **PLatinum** series

With 3 actuators



LPZP3B8908

LPZP3B8909



LPZP3B8910

LPZP3B8911



LPZP3B8912

new

Order code	Description	Contacts config.	Qty per pkg	Wt
			n°	[kg]
Grey control station.				
LPZP3B8908	White spring return flush pushbutton with "right arrow" symbol	1NO	1	0.271
	Red spring return flush pushbutton with "0" symbol	1NC	1	
	Black spring return flush pushbutton with "left arrow" symbol	1NO	1	
LPZP3B8909	White spring return flush pushbutton with "right arrow" symbol	1NO	1	0.272
	Red spring return extended pushbutton with "0" symbol	1NC	1	
	Black spring return flush pushbutton with "left arrow" symbol	1NO	1	
LPZP3B8910	Green spring return flush pushbutton with "I" symbol	1NO	1	0.270
	Red spring return flush pushbutton with "0" symbol	1NC	1	
	Green steady pilot light 12...30VAC/DC	–		
LPZP3B8911	Green spring return flush pushbutton with "I" symbol	1NO	1	0.271
	Red spring return extended pushbutton with "0" symbol	1NC	1	
	Green steady pilot light 12...30VAC/DC	–		
LPZP3B8912	Green spring return flush pushbutton	1NO	1	0.278
	Red spring return flush pushbutton	1NC	1	
	Mushroom head spring return pushbutton	1NC	1	

General characteristics

- Compact dimensions
- Easy wiring
- Numerous cable entries
- Contact elements and LED elements, base-mount on control station.

Operational characteristics

- Cable entry knockouts:
 - M16/PG11 (2 at rear)
 - M20/PG13.5 (2 on each side)
 - M20/M25/PG13.5/PG16 (1 each on top and bottom)
- Any mounting position allowed
- Tightening torque of cover screws $T_{max} = 1.8Nm/16lb.in$
- Ambient conditions:
 - Operating temperature: $-25...+70^{\circ}C$
 - Storage temperature: $-40...+85^{\circ}C$
- Degree of protection:
 - Per IEC/EN: IP66, IP67 and IP69K
 - Per UL: Type 1, 2, 3R, 4, 4X, 12K.

Materials

Polycarbonate.

Certifications and compliance

Certifications obtained: cULus, EAC, CCC, RINA.
 Compliant with standards: IEC/EN/BS 60947-1, IEC/EN/BS 60947-5-1, UL508A, CSA C22.2 n° 14.

Type LP9...



LP9S...R



LP9S...B



LP9P...R

new

Order code	Description	Qty	Wt
		per pkg	
		n°	[kg]
LP9S01R	Momentary Ø90mm/3.54" red mushroom. Contacts: 1NC	1	0.210
LP9S11R	Momentary Ø90mm/3.54" red mushroom. Contacts: 1NO+1NC	1	0.220
LP9S10B	Momentary Ø90mm/3.54" black mushroom. Contacts: 1NO	1	0.210
LP9S11B	Momentary Ø90mm/3.54" black mushroom. Contacts: 1NO+1NC	1	0.220
LP9P02R	Emergency Ø90mm/3.54" red mushroom pull-to-release. Contacts: 2NC	1	0.290
LP9P11R	Emergency Ø90mm/3.54" red mushroom pull-to-release. Contacts: 1NO+1NC	1	0.300

Momentary mushroom

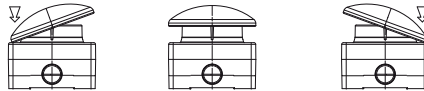

Emergency mushroom pull-to-release

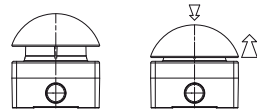

Accessories



LP9XC...

Order code	Description	Qty	Wt
		per pkg	
		n°	[kg]
LP9XC10	1NO contact	1	0.010
LP9XC01	1NC contact	1	0.010

❶ Maximum configuration: n°3 LP9XC... contact elements.

General characteristics

LOVATO Electric palm switches LP9... types are designed for machine stop and immediate service control applications. They are widely used in the most diverse applications, including emergency stop for escalators, gate openers, pedestrian crossing buttons for disabled users, etc... The ergonomic design and large surface for an easy actuation with the hand, elbow or foot, ensures immediate actuation of machinery and equipment even if the operator has his hands full.

This new range is split into two versions:

- Momentary mushroom (available in grey/black or grey/red);
- Emergency mushroom "pull-to-release" (available in yellow/red only).

Operational characteristics

- Cable entry (knockout version):
 - M20/PG13.5 (1 on each side)
 - M16/PG11 (2 on the cover bottom)
- Any mounting position allowed
- Tightening torque of cover screws $T_{max} = 0.8Nm/7lb.in$
- Ambient conditions:
 - Operating temperature: $-25...+75^{\circ}C$
 - Storage temperature: $-40...+85^{\circ}C$
- IEC/EN degree of protection: IP65.

CONTACT ELEMENTS

- Rated insulation voltage: 690V
- Rated thermal current Ith: 10A
- Conductivity: 5V 10mA
- Tightening torque of contact screws: 0.5...0.8Nm
- Conductor cross section: 1 or 2 conductors - 0.5...2.5mm²
- IEC/EN 60947-5-1 designation: A600 Q300.

Minimum operational characteristics in AC15:

[V]	12	24	48	120	240	400	480	500	600
[A]	6	6	6	6	3	1.9	1.5	1.4	1.2

Minimum operational characteristics in DC13:

[V]	12	24	48	125	250	440	500	600
[A]	3	3	1.5	0.55	0.27	0.15	0.13	0.1

Operational characteristics in AC15: 24V 10A and 400V 4A

- Short-circuit protection fuse: max. calibre 10A gG/gL
- Contact resistance: $\leq 25m\Omega$
- Operating force: $\leq 2.6N$
- Mechanical life: 1,000,000 cycles.

Stroke of contact elements

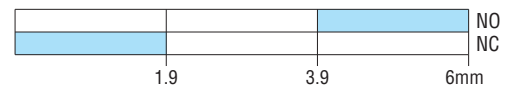

Closed contact
 Open contact

Material

PC-ABS for button and control station.
PA66 for plastic operator frame (LP9S...).
Chrome-plated aluminium and zinc alloy (zama) for metal operator frame (LP9P...).

Compliance

Compliant with standards: IEC60947-5-1.

Enclosures with cut-outs for Ø22mm units



LPZM1A5 LPZM1A5P



LPZM1A8



LPZM2A5 LPZM2A8

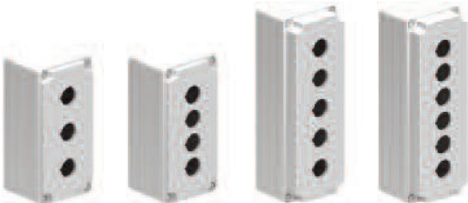

LPZM3A8 LPZM4A8 LPZM5A8 LPZM6A8



LPZM4CA8 LPZM6CA8



LPZM8CA8 LPZM12CA8



LPZM16CA8

Order code	Description	Cover colour	Qty per pkg	Wt
			n°	[kg]
With holes.				
LPZM1A5	For 1 actuator	Yellow	1	0.343
LPZM1A5P [Ⓢ]	For 1 actuator with shroud	Yellow	1	0.382
LPZM1A8	For 1 actuator	Grey	1	0.349
LPZM2A5	For 2 actuators	Yellow	1	0.456
LPZM2A8	For 2 actuators	Grey	1	0.458
LPZM3A8	For 3 actuators	Grey	1	0.603
LPZM4A8	For 4 actuators	Grey	1	0.581
LPZM5A8	For 5 actuators	Grey	1	0.680
LPZM6A8	For 6 actuators	Grey	1	0.671
With multiholes.				
LPZM4CA8	For 4 actuators	Grey	1	0.570
LPZM6CA8	For 6 actuators	Grey	1	0.660
LPZM8CA8	For 8 actuators	Grey	1	1.060
LPZM12CA8	For 12 actuators	Grey	1	1.360
LPZM16CA8	For 16 actuators	Grey	1	1.650

[Ⓢ] It is not possible to use plastic disks in combination with enclosure with protection.

General characteristics

Enclosures made of aluminium alloy suitable for pushbuttons, selector switches and pilot lights Ø22mm/0.87" Platinum series.

Possible use of contact elements on the inside surface of the cover using the relevant mounting adapter.

The thickness of the enclosure is suitable for drilling.

Up to 6 contacts can be fitted; 2 each on the left, middle and right, one behind the other.

For the possible combinations consult this chapter on the actuator pages.

Operational characteristics

- Cable entry: Ø21mm/0.83" (for M20 or PG13.5 cable gland)
- Degree of protection:
 - Per IEC/EN: IP66 and IP67
 - Per UL: Nema 4X
- Earth connection through threaded holes on the base and on the cover (screws supplied)
- Ambient conditions:
 - Operating temperature: -25...+70°C
 - Storage temperature: -40...+85°C.

Certifications and compliance

Certifications obtained: cULus.
Compliant with standards: IEC/EN/BS 60947-5-1.

ⓘ Not available for multiholes LPZM...C type.

Order codes	Dimensions (X, Y, Z) [mm (in)]	n° of rows vertical	n° of rows horizontal
LPZM1A5/A8	80x80x73 (3.15x3.15x2.87")	1	1
LPZM1A5P	80x80x108 (3.15x3.15x4.25")	1	1
LPZM2A5/A8	80x130x73 (3.15x5.12x2.87")	1	2
LPZM3A8	80x170x73 (3.15x6.69x2.87")	1	3
LPZM4A8	80x170x73 (3.15x6.69x2.87")	1	4
LPZM5A8	80x230x73 (3.15x9.05x2.87")	1	5
LPZM6A8	80x230x73 (3.15x9.05x2.87")	1	6
LPZM4CA8	80x170x73 (3.15x6.69x2.87")	2	2
LPZM6CA8	80x230x73 (3.15x9.05x2.87")	2	3
LPZM8CA8	160x160x90 (6.30x6.30x3.54")	4	2
LPZM12CA8	170x190x90 (6.69x7.48x3.54")	4	3
LPZM16CA8	190x250x90 (7.48x9.84x3.54")	4	4

Enclosures



LPZM1E5 **LPZM1E8**

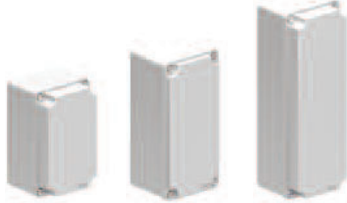

LPZM2E8 **LPZM3E8** **LPZM4E8**

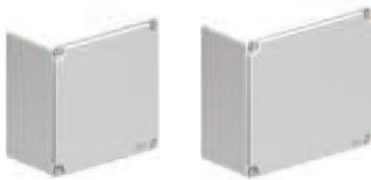

LPZM5E8 **LPZM6E8**



LPZM7E8

Order code	Dimensions (X, Y, Z)	Cover colour	Qty per pkg.	Wt.
	[mm (in)]		n°	[kg]
LPZM1E5	80x80x73 (3.15x3.15x2.87")	Yellow	1	0.346
LPZM1E8	80x80x73 (3.15x3.15x2.87")	Grey	1	0.352
LPZM2E8	80x130x73 (3.15x5.12x2.87")	Grey	1	0.462
LPZM3E8	80x170x73 (3.15x6.69x2.87")	Grey	1	0.600
LPZM4E8	80x230x73 (3.15x9.05x2.87")	Grey	1	0.680
LPZM5E8	160x160x90 (6.30x6.30x3.54")	Grey	1	1.100
LPZM6E8	170x190x90 (6.69x7.48x3.54")	Grey	1	1.400
LPZM7E8	190x250x90 (7.48x9.84x3.54")	Grey	1	1.700

General characteristics

Enclosures made of aluminium alloy suitable for pushbuttons, selector switches and pilot lights Ø22mm/0.87" Platinum series.

Possible use of contact elements on the inside surface of the cover using the relevant mounting adapter.

The thickness of the enclosure is suitable for drilling.

Up to 6 contacts can be fitted; 2 each on the left, middle and right, one behind the other.

For the possible combinations consult this chapter on the actuator pages.

Operational characteristics

- Degree of protection:
 - Per IEC/EN: IP66 and IP67
 - Per UL: Nema 4X
- Earth connection through threaded holes on the base and on the cover (screws supplied)
- Ambient conditions:
 - Operating temperature: -25...+70°C
 - Storage temperature: -40...+85°C.

Certifications and compliance

Certifications obtained: cULus.

Compliant with standards: IEC/EN/BS 60947-5-1.

Order code	Max. operator number	n° of rows vertical	n° of rows horizontal
LPZM1E5/E8	1	1	1
LPZM2E8	2	1	2
LPZM3E8	4	1	3
LPZM4E8	6	1	5
LPZM5E8	8	4	2
LPZM6E8	12	4	3
LPZM7E8	16	4	4

7 Pushbuttons and selector switches

PLatinum series dimensions [mm (in)]

LPXAU120M WITH CONTACT ELEMENTS

Flush pushbutton with screw terminal contact or LED or test elements

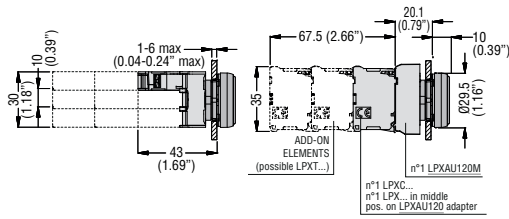

Flush pushbutton with Faston contact elements

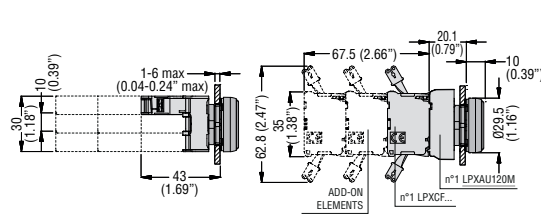

Drillings - Minimum recommended distances

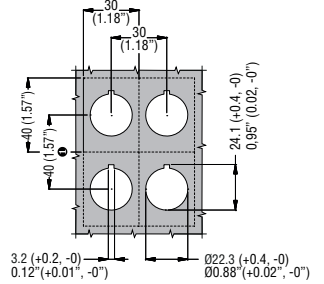

When Faston contacts are used, the vertical pitch must be 85mm minimum.

Mushroom-head pushbutton with auto-monitor contacts

LPXC01SM

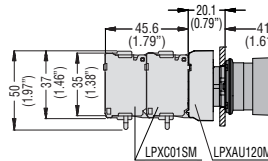
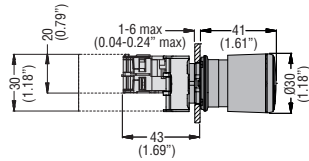

LPXC02SM

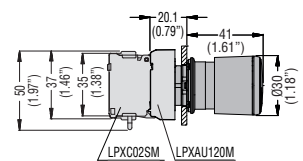
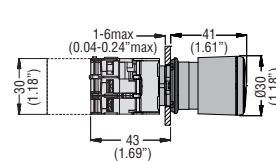

Flush pushbutton with test element and spring-clamp terminal contact or LED elements LPXCS... - LPXLPS...

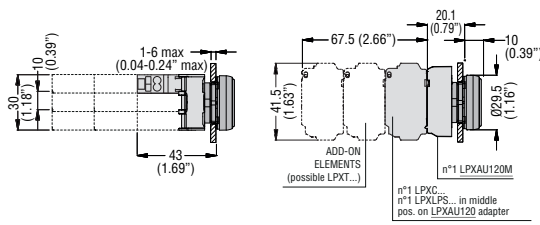

Drillings - Minimum recommended distances with spring-clamp terminal contact or LED elements

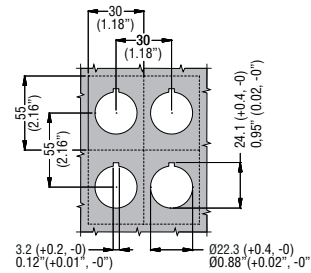

LPXAU120 WITH CONTACT ELEMENTS

Flush pushbutton with screw terminal contact or LED or test elements

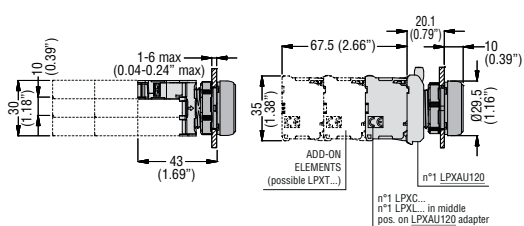

Flush pushbutton with Faston contact elements

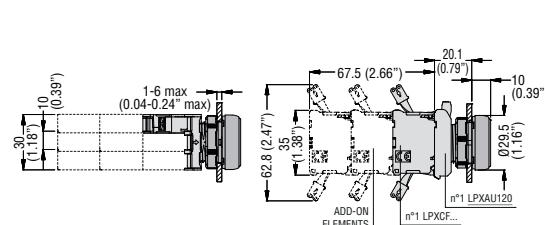

Drillings - Minimum recommended distances

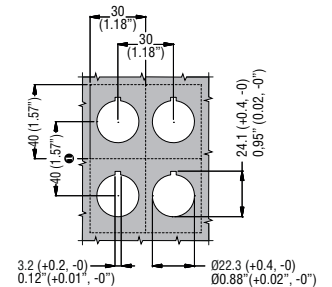

When Faston contacts are used, the vertical pitch must be 85mm minimum.

Mushroom-head pushbutton with auto-monitor contacts

LPXC01SM

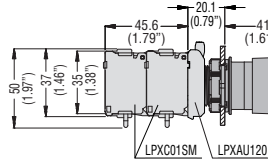
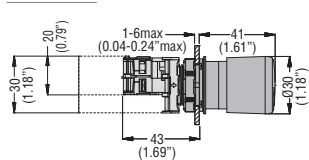

LPXC02SM

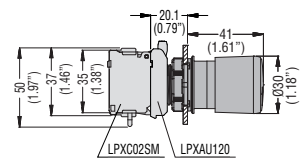
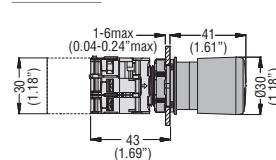

Flush pushbutton with test element and spring-clamp terminal contact or LED elements LPXCS... - LPXLPS...

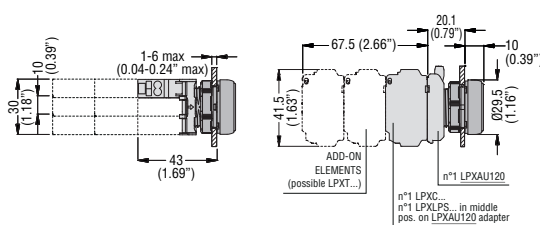

Drillings - Minimum recommended distances with spring-clamp terminal contact or LED elements

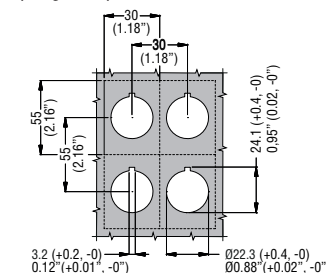

7 Pushbuttons and selector switches

PLatinum series dimensions [mm (in)]

LPS TYPES

Spring-return and push-push buttons

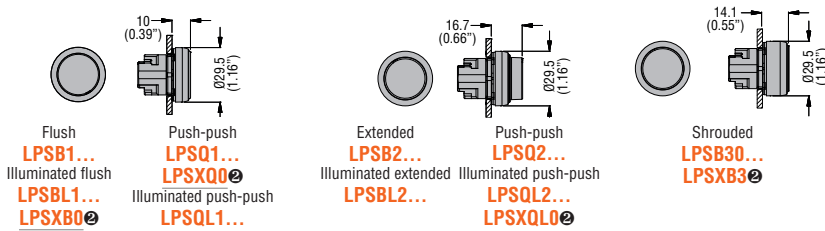

⊗ Complete with cap or lens.

Mechanical buttons

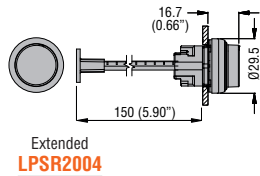
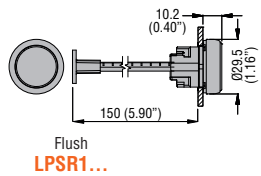

Mushroom-head button actuators

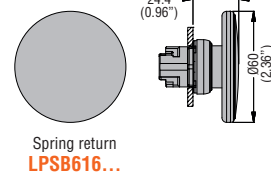
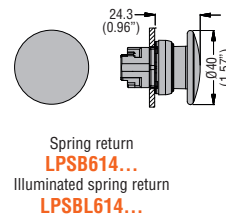

Mushroom-head latch button actuators

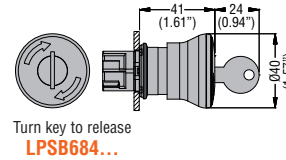
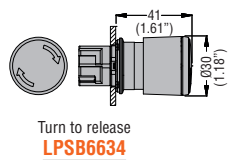
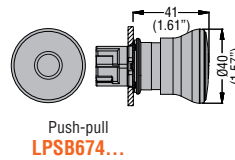

Selector switch actuators

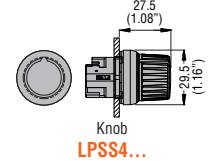
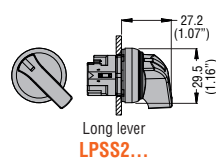
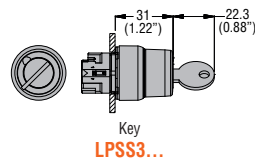
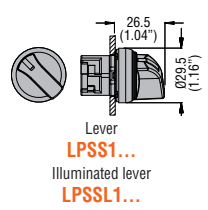

Flush double-touch buttons with or without light indicator

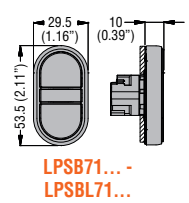

Double-touch buttons with an extended button with or without light indicator

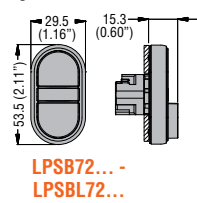

Triple-touch button with middle extended button

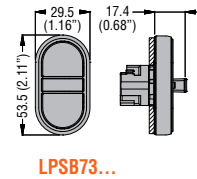

Drillings - Minimum recommended distances

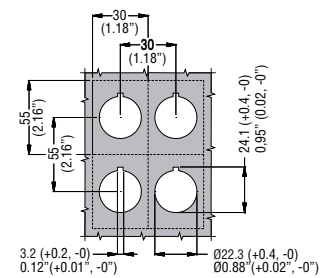

Pilot light head

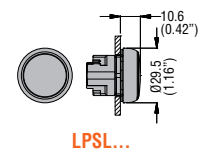

Joystick with free actuation lever

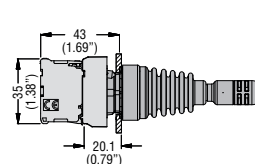
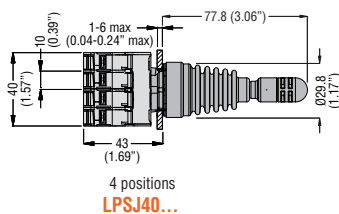
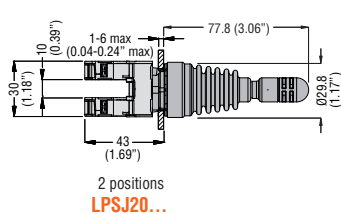

Joystick with mechanical latch lever

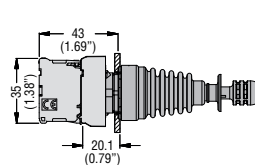
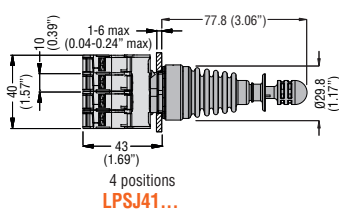
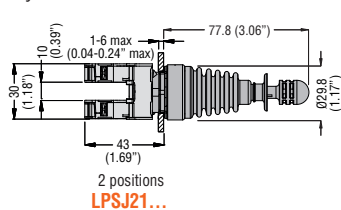

LPF TYPES

Spring-return and push-push buttons

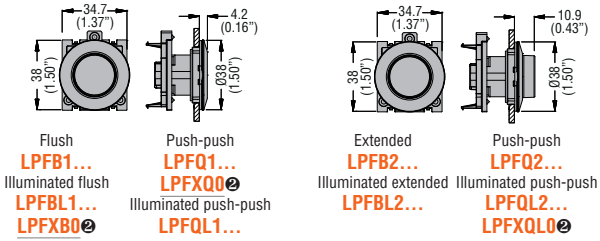

② Complete with cap or lens.

Selector switch actuators

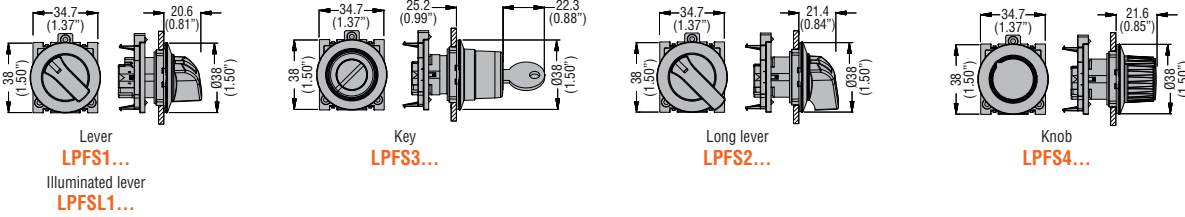

Communication interfaces **LPSPD...**

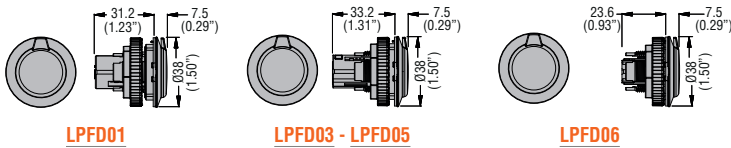

Drillings - Minimum recommended distances

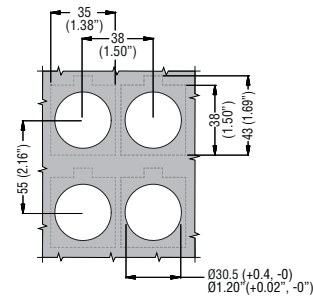

Pilot light head

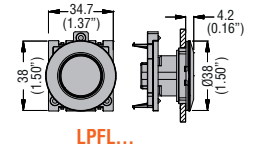

LPC TYPES

Spring-return and push-push buttons

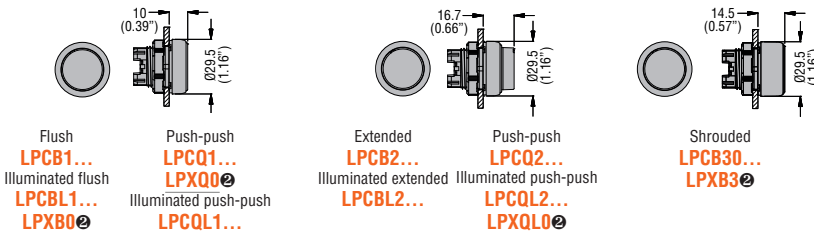

② Complete with cap or lens.

Mechanical buttons

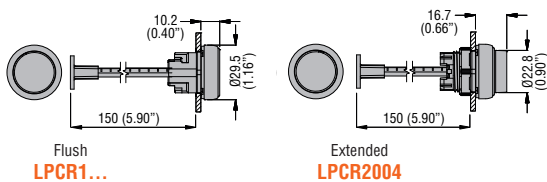

Mushroom-head button actuators

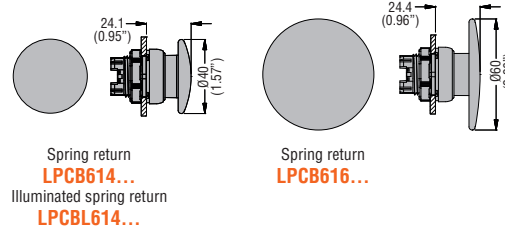

Mushroom-head latch button actuators

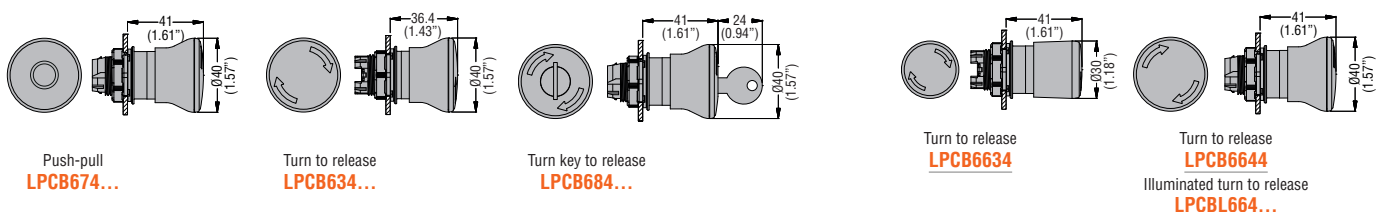

7 Pushbuttons and selector switches

PLatinum series dimensions [mm (in)]

Selector switch actuators

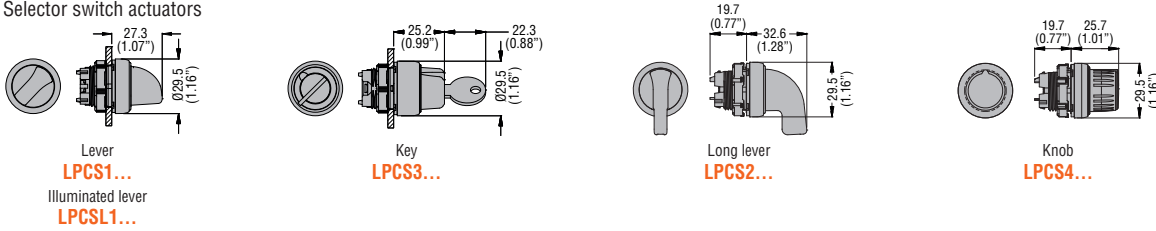

Flush double-touch buttons with or without light indicator

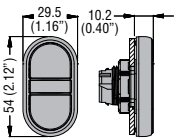

Double-touch buttons with an extended button with or without light indicator

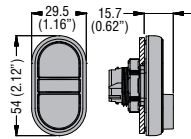

Triple-touch button with middle extended button

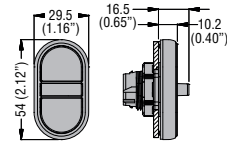

Drillings - Minimum recommended distances

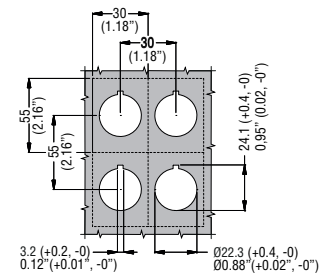

Pilot light head

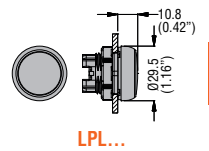

Communication interfaces LPCD...

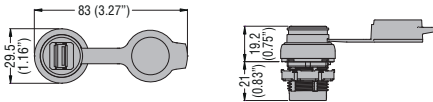

LED-integrated monoblock pilot lights

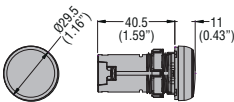

Monoblock buzzers

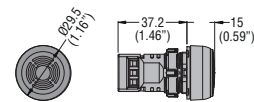

Monoblock potentiometer

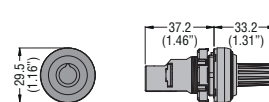

PLATINUM ACCESSORIES

Threaded plug for unused drilled holes

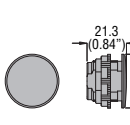

Knob selector switch protection

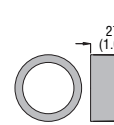

Label holder

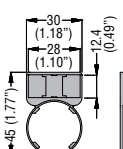

Label

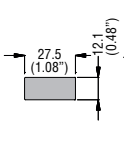

Label holder

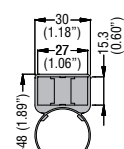

Label

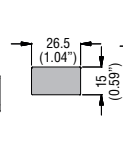

Plastic disk for mushroom-head pushbuttons

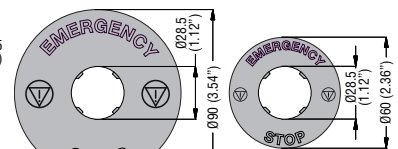

Rubber boot for flush buttons

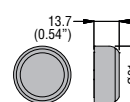

Rubber boot for extended buttons

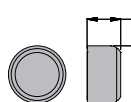

Double/triple button boot

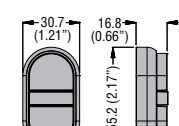

Rubber boot for mushroom-head buttons

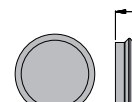

Padlockable protection for mushroom-head latch buttons

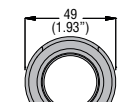

Cable gland

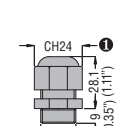

Shroud for mushroom-head latch buttons

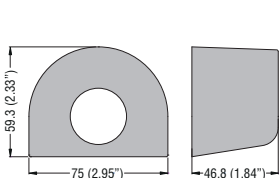

DIN rail adapter

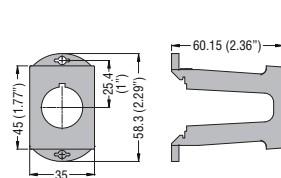

Protection covers

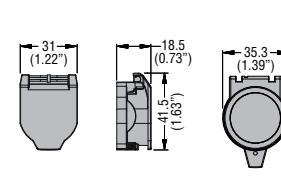

Illuminated disk for mushroom-head pushbuttons

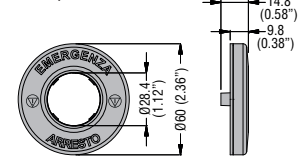

PLASTIC CONTROL STATIONS

LPZP1A5 - LPZP1A8
LPZP1B5... - LPZP1B8...

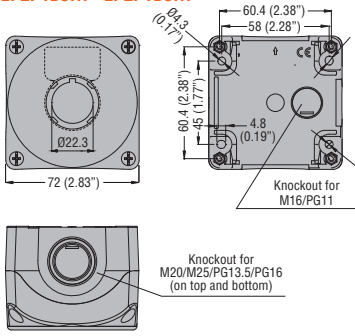

LPZP1A5P
LPZP1A8P

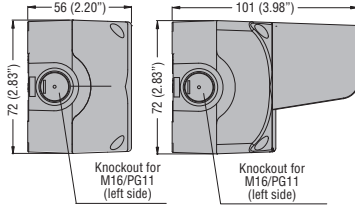

LPZP2A5 - LPZP2A8
LPZP2B5... - LPZP2B8...

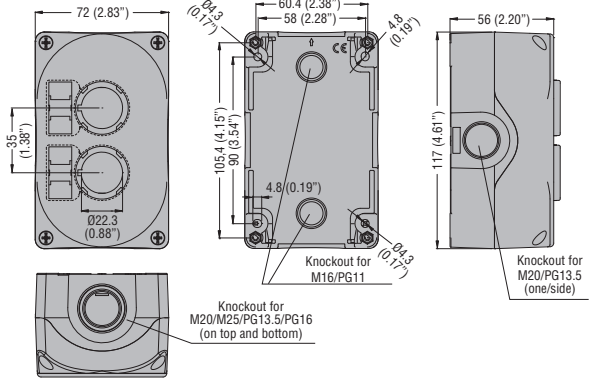

LPZP3A8
LPZP3B8...

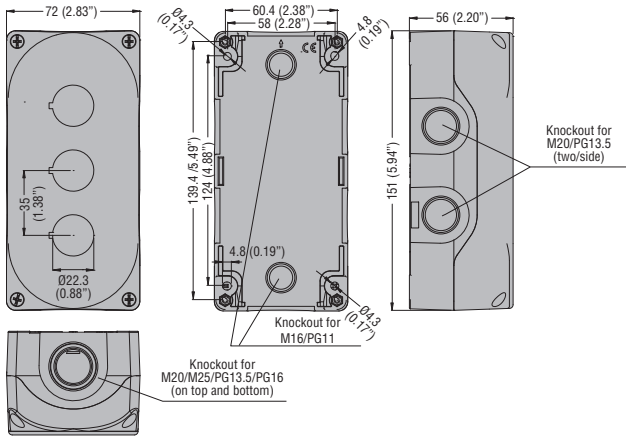

LPZP4A8

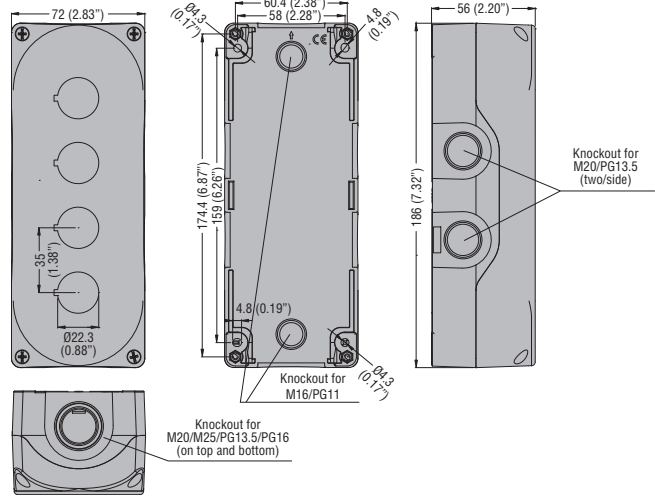

LPZP5A8

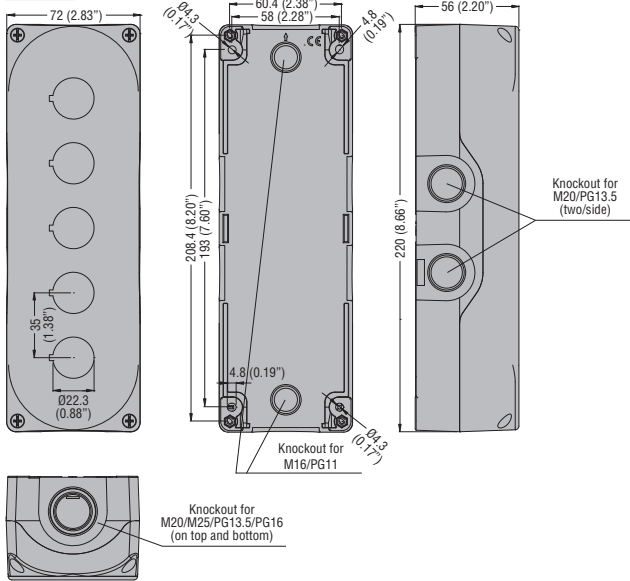

LPZP6A8

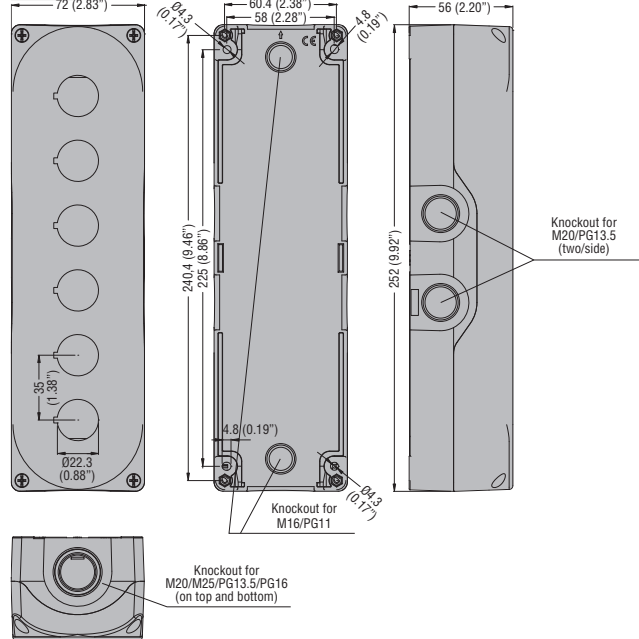

7 Pushbuttons and selector switches

PLatinum series dimensions [mm (in)]

PALM SWITCHES

LP9...

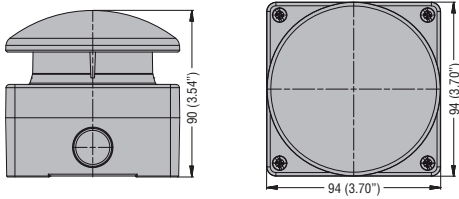

METAL CONTROL STATIONS

LPZM1A...

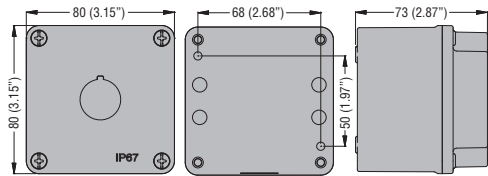

LPZM1A5P

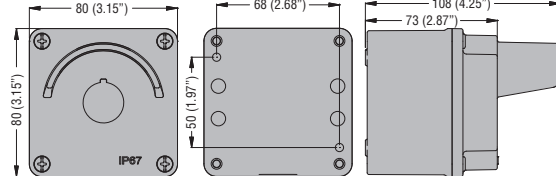

LPZM2A...

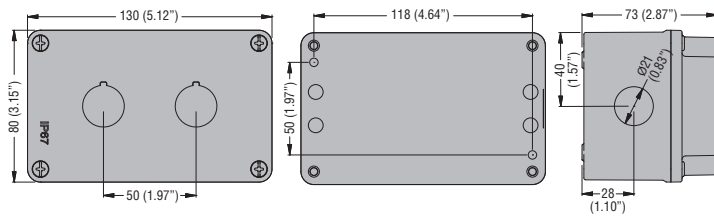

LPZM3A8

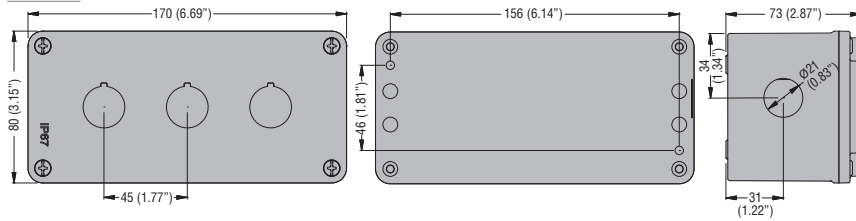

LPZM4A8

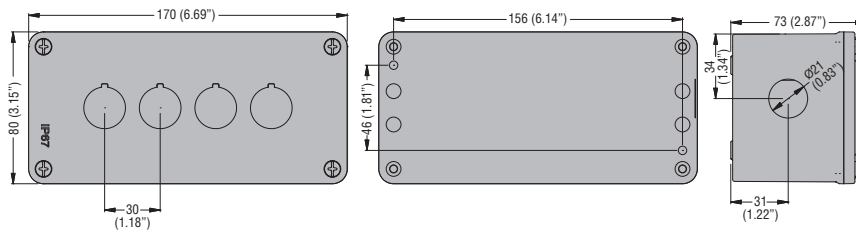

LPZM5A8

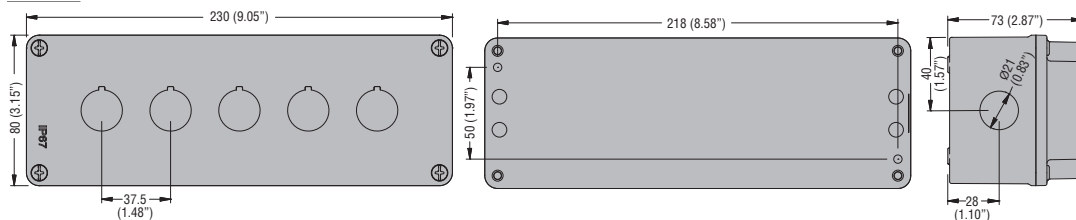

LPZM6A8

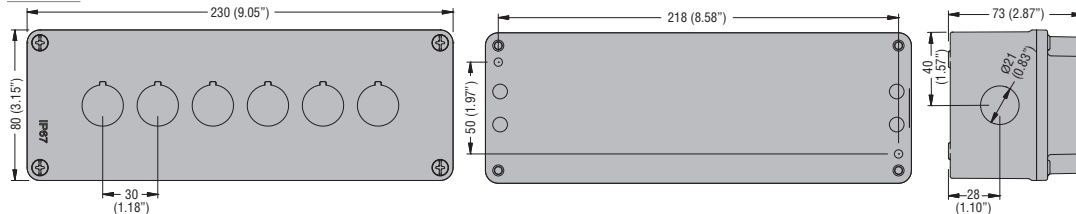

7 Pushbuttons and selector switches

PLatinum series dimensions [mm (in)]

LPZM1E...

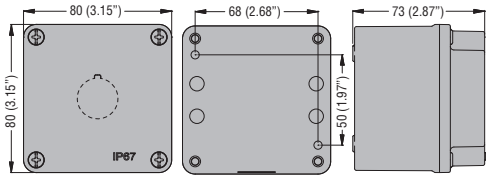

LPZM2E8

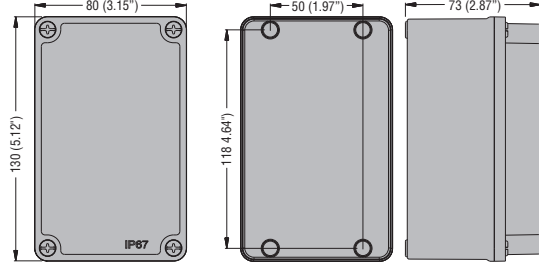

LPZM4CA8 - LPZM3E8

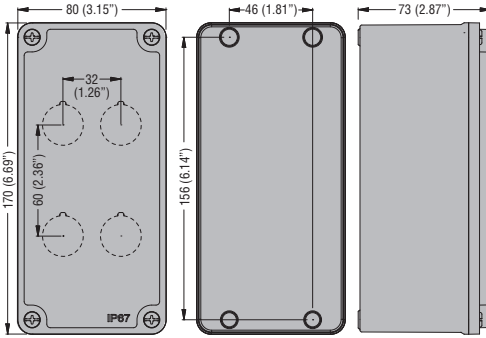

LPZM6CA8 - LPZM4E8

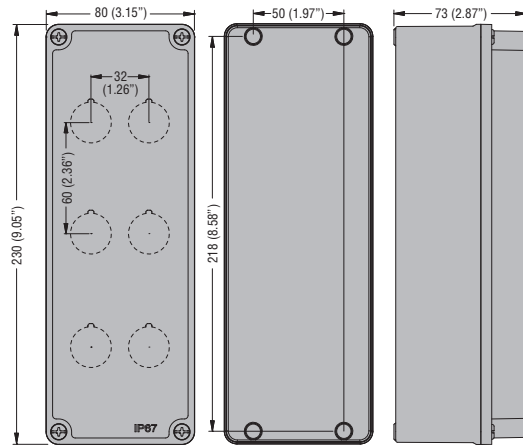

LPZM8CA8 - LPZM5E8

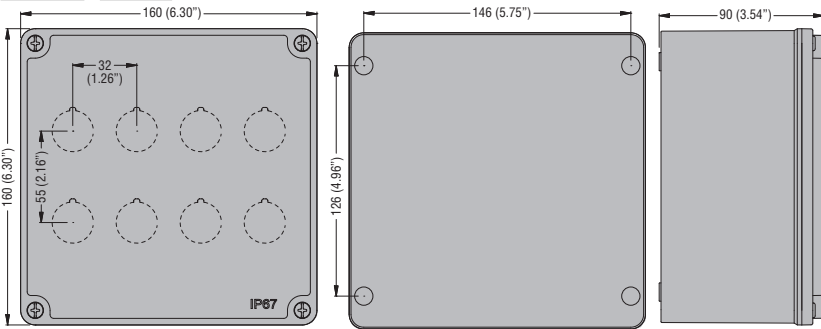

LPZM12CA8 - LPZM6E8

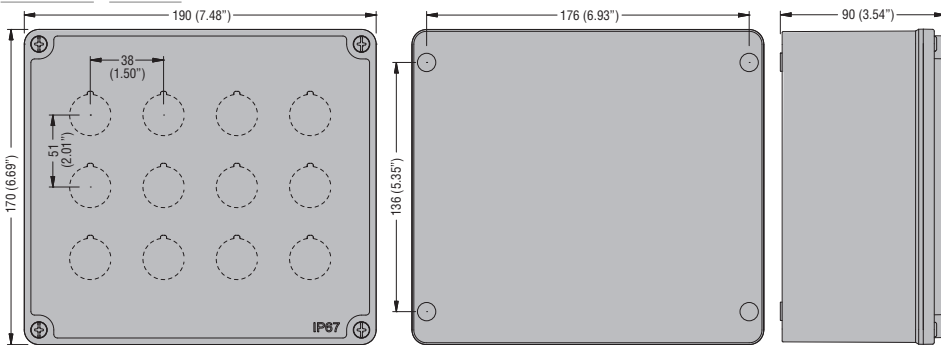

LPZM16CA8 - LPZM7E8

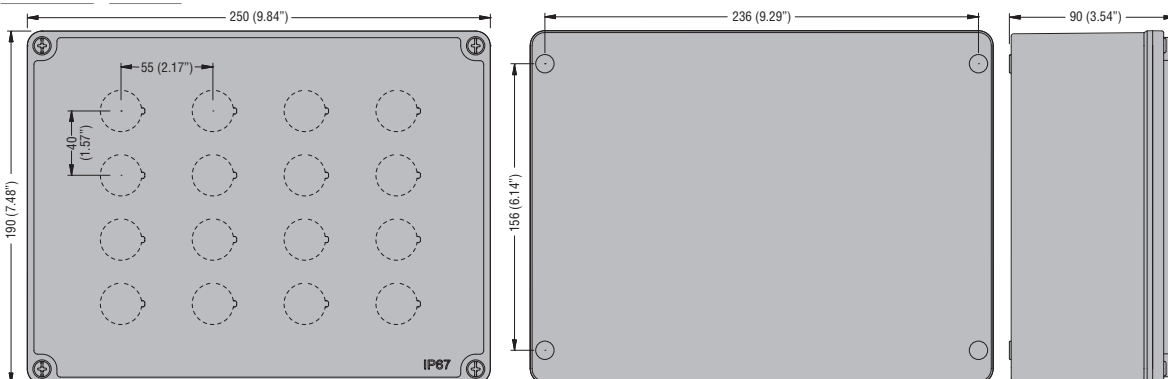

FOR PUSHBUTTONS AND SELECTOR SWITCHES

LPXC10 - LPXE10... - LPXCF10
LPXCS10 - LPXCB10

LPXC10A

LPXC01 - LPXE01... - LPXCF01
LPXCS01 - LPXCB01
LPZP1B...

LPXC01D

LPXC01SM

LPXC02SM

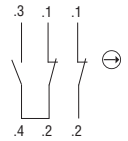
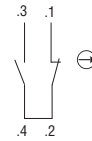
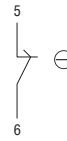
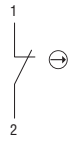

LPM...
LPXL...

LPCZS...

LPXT100

LPXT101
LPXT102

LPCPA...

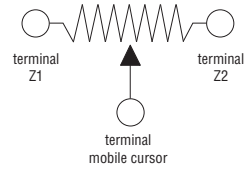
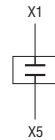
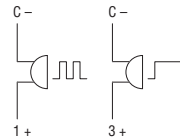
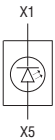

LP9S01R

LP9S11B
LP9S11R
LP9P11R

LP9S10B

LP9P02R

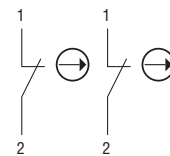
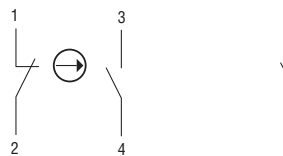
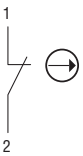

LPFD01 - LPCD01

LPFD03 - LPCD03

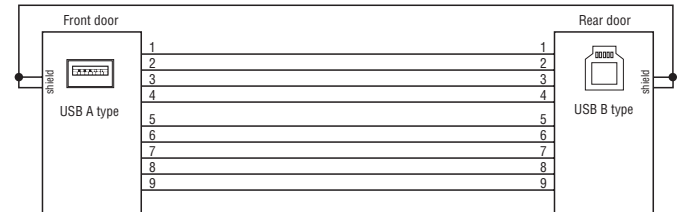
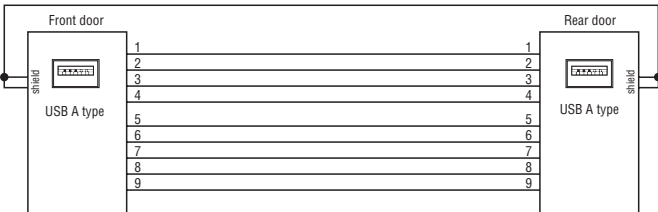

LPFD05 - LPCD05

LPFD06 - LPCD06

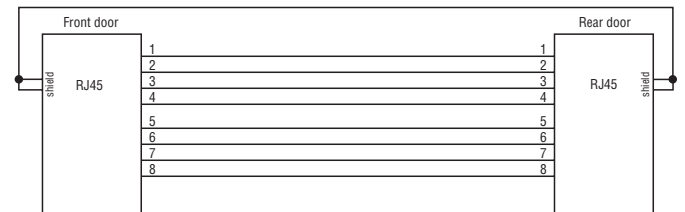
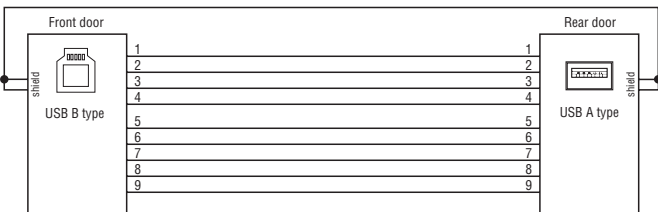



- Signal towers ready assembled Ø45mm/1.77" 8LT4... series
Steady light and pulsed or continuous sound modules
- Signal towers Ø50mm/1.97" and Ø70mm/2.75" LTN... series
Modular and combinations up to 5 modules; steady or blinking light.
- Multicoloured signal towers Ø70mm/2.75" 8LT73... type
Modular and combinations up to 5 modules; steady light and pulsed or continuous sound modules
- Signal towers Ø70mm/2.75" 8LT7... series
Modular and combinations up to 7 modules; steady or blinking light, pulsed or continuous sound modules
- Signal beacons Ø62mm/2.44" 8LB... series
Steady or blinking light, pulsed or continuous sound modules.

Signal towers and beacons

	SEC. - PAGE
Signal towers ready assembled Ø45mm/1.77" 8LT4... series	8 - 2
Signal towers Ø50mm/1.97" LTN... series	8 - 3
Signal towers Ø70mm/2.75" LTN... series	8 - 4
Multicoloured signal towers Ø70mm/2.75" 8LT73... type	8 - 5
Signal towers Ø70mm/2.75" 8LT7... series	8 - 6
Signal beacons Ø62mm/2.44" 8LB... series	8 - 8

Dimensions	8 - 12
Wiring diagrams	8 - 17

Visual code	Red	Yellow Orange	Blue	Green	White
Meaning	Danger. Emergency.	Warning and caution. Abnormal situation.	Mandatory command.	Normal situation. Regular operation.	No specific meaning.
Sound	Fast modulated repetition or high-pitch pulsing.	Continuous short sound.	Alternating sound at constant tone	Constant and prolonged sound after an alarm.	Other sounds.
Correlated actions	Immediate intervention to deal with dangerous situation.	Control intervention required.	Intervention needed for mandatory action.	No specific action.	Depending on the situation.

Interpretation of light and sound signals for signal towers and beacons

Light and sound signals are a fundamental element for the safety of a system.

To avoid incorrect interpretations, a European standard has been introduced attributing an unambiguous meaning to visual or audible signals.

Each colour or sound alarm corresponds to a specific state of operation of the connected system and various levels of warning, as shown in the table above, according to EN 981-IEC/EN/BS 60073 standards. The white module can be assigned a meaning as desired.



Page 8-2

**SIGNAL TOWERS READY ASSEMBLED
Ø45mm/1.77" 8LT4... SERIES**

- Signal towers supplied already assembled Ø45mm/1.77"
- Steady light modules
- Pulsed or continuous sound modules
- Built-in LED circuit.



Page 8-3

SIGNAL TOWERS Ø50mm/1.97" LTN... SERIES

- Modular signal towers supplied Ø50mm/1.97"
- Steady light or blinking modules
- Continuous sound modules
- Built-in LED bulb.



Page 8-4

SIGNAL TOWERS Ø70mm/2.75" LTN... SERIES

- Modular signal towers supplied Ø70mm/2.75"
- Steady light or blinking modules
- Continuous sound modules
- Built-in LED bulb.



Page 8-5

**MULTICOLOURED SIGNAL TOWERS
Ø70mm/2.75" 8LT73... TYPE**

- Modular signal towers Ø70mm/2.75"
- Steady light multicoloured modules
- Pulsed or continuous sound multicoloured modules
- Built-in LED circuit.



Page 8-6 and 7

**SIGNAL TOWERS Ø70mm/2.75"
8LT7... SERIES**

- Modular signal towers supplied Ø70mm/2.75"
- Steady light modules
- Pulsed or continuous sound modules
- Incandescent and LED bulbs.



Page 8-8

SIGNAL BEACONS Ø62mm/2.44"

- Modular signal towers Ø62mm/2.44"
- Steady light or blinking modules
- Pulsed or continuous sound multicoloured modules
- Incandescent and LED bulbs.

Signal towers ready assembled Ø45mm/1.77", 8LT4... series



8LT4K02BG



8LT4K05BG



8LT4K09BG

Order code	Description	Qty per pkg	Wt
		n°	[kg]
Steady light and pulsed or continuous sound light modules. Built-in LED circuit ❶.			
8LT4K02BG	Green, red, 24VDC	1	0.160
8LT4K03BG	Green, red with continuous or pulsed sound, 24VDC	1	0.240
8LT4K04BG	Green, orange, red, 24VDC	1	0.240
8LT4K05BG	Green, orange, red with continuous or pulsed sound, 24VDC	1	0.320
8LT4K06BG	Green, blue, orange, red, 24VDC	1	0.320
8LT4K07BG	Green, blue, orange, red, with continuous or pulsed sound, 24VDC	1	0.400
8LT4K08BG	White, green, blue, orange, red, 24VDC	1	0.400
8LT4K09BG	White, green, blue, orange, red, with continuous or pulsed sound, 24VDC	1	0.480

❶ For accessories and spare parts see page 8-9 and 10.

General characteristics

The Ø45mm/1.77" signal towers are supplied completely assembled with the possibility of up to 3 light modules with a sound module. The high-brightness LED circuit lighting ensures low consumption and long life.

Technical characteristics

- Supply voltage: 24VDC (±10%)
- Light module consumption: 37mA per module
- Sound module consumption: 15mA
- Sound intensity: 80dB/1m, pulsed or continuous sound
- Material: polycarbonate
- Connections: screw clamp terminals and maximum conductor section 1.5mm²/16AWG
- Tightening torque: 0.5Nm/4.5lb.in
- Operating temperature: -20...+50°C
- IEC degree of protection: IP54.

Certifications and compliance

Certifications obtained: cULus, EAC.
Compliant with standards: IEC/EN/BS 60947-5-1, IEC/EN/BS 60947-1, UL508, CSA C22.2 n° 14.

Combinations

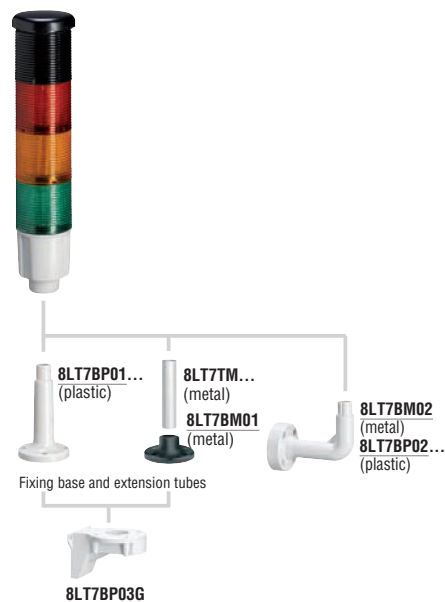

For accessories and spare parts see page 8-9 and 10.

Signal towers Ø50mm/1.97" LTN... series



LTN50ML1



LTN50MSL



LTN50MSH



LTN50MW024



LTN50C



LTN50BP1



LTN50BM1



LTN50BP2



LTN50BM2



LTN50BP3



LTN50BM3



LTN50P100



LTN50P100T

new

Order code	Description	Qty per pkg	Wt. [kg]
	Blinking or steady light modules. Integrated LED lamp.	n°	[kg]
LTN50ML1	Orange	1	0.037
LTN50ML3	Green	1	0.037
LTN50ML4	Red	1	0.037
LTN50ML6	Blue	1	0.037
LTN50ML8	White	1	0.037
	Continuous sound modules		
LTN50MSL	85dB. IP65, Type 4	1	0.050
LTN50MSH	100dB. IP20	1	0.048
	Wiring modules.		
LTN50MW024	12...24VDC	1	0.136
LTN50MW230	110...230VAC	1	0.222
	Top cover.		
LTN50C	To be used only if sound module is not present	5	0.010
	Fixing bases.		
LTN50BP1	Horizontal surface mounting, black plastic	1	0.032
LTN50BP2	Wall mounting, grey plastic	1	0.046
LTN50BP3	Horizontal surface or wall mounting, black plastic	1	0.076
LTN50BM1	Horizontal surface mounting, metal	1	0.072
LTN50BM2	Wall mounting, metal	1	0.088
LTN50BM3	Horizontal surface or wall mounting, metal	1	0.173
	Extension tubes		
LTN50P100	100mm/3.94", metal	5	0.028
LTN50P250	250mm/9.84", metal	5	0.068
LTN50P400	400mm/15.75", metal	5	0.109
LTN50P100T	100mm/3.94", metal with threaded end	5	0.027
LTN50P250T	250mm/9.84", metal with threaded end	5	0.066
LTN50P400T	400mm/15.75", metal with threaded end	5	0.108

- ❶ For light towers including both white light module and sound modules please check the wiring diagram at page 8-17.
- ❷ For fixing base LTN50BP2 the extension tube LTNP... without threaded end has to be used.
- ❸ Extension tubes with threaded end LTNP...T have to be used for all the fixing bases except for LTN50BP2.

General characteristics

Signal towers are fundamental elements in manufacturing processes for the visual and audible signaling of the system status. The signal towers can be assembled by stacking up to 5 light modules or 4 light modules and 1 sound module.

Technical characteristics

- Maximum operational voltage: 26.4VDC - 240VAC
- Light, sound and wiring modules consumption:
 - light modules: 1.2VA
 - sound modules: 1.7VA
 - wiring modules: 1VA
- Number of stackable modules: 5
- Connections: screw clamp terminals and conductor section 0.25...1.5mm²/AWG16...24
- Operating temperature: -30...+50°C
- IEC degree of protection: IP65 for wiring modules, light modules, top cover and sound module LTN50MSL.

Certifications and compliance

Certifications obtained: cULus, EAC. Compliant with standards: IEC/EN/BS 60947-5-1, IEC/EN/BS 60947-1, UL508, CSA C22.2 n° 14.

Combinations

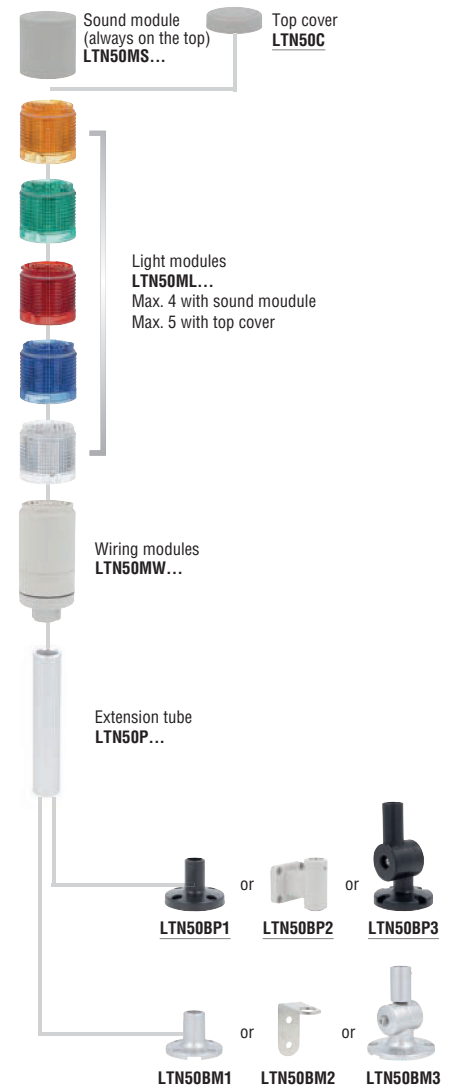

Signal towers Ø70mm/2.75" LTN... series



LTN70ML3



LTN70MSL



LTN70MSH



LTN70MW024



LTN70C

new



LTN70BP1



LTN70BM1



LTN70BP2



LTN70BM2



LTN70BP3



LTN70BM3



LTN70P100



LTN70P100T

Order code	Description	Qty per pkg	Wt.
		n°	[kg]

Blinking or steady light modules.
Integrated LED lamp.

LTN70ML1	Orange	1	0.066
LTN70ML3	Green	1	0.066
LTN70ML4	Red	1	0.066
LTN70ML6	Blue	1	0.066
LTN70ML8	White	1	0.066

Continuous sound modules.

LTN70MSL	85dB. IP65, Type 4	1	0.065
LTN70MSH	100dB. IP20	1	0.062

Wiring modules.

LTN70MW024	12...24VDC	1	0.170
LTN70MW230	110...230VAC	1	0.277

Top cover.

LTN70C	To be used only if sound module is not present	5	0.014
--------	--	---	-------

Fixing bases.

LTN70BP1	Horizontal surface mounting, black plastic	1	0.040
LTN70BP2	Wall mounting, grey plastic	1	0.067
LTN70BP3	Horizontal surface or wall mounting, black plastic	1	0.094
LTN70BM1	Horizontal surface mounting, metal	1	0.101
LTN70BM2	Wall mounting, metal	1	0.131
LTN70BM3	Horizontal surface or wall mounting, metal	1	0.242

Extension tubes.

LTN70P100	100mm/3.94", metal	5	0.043
LTN70P250	250mm/9.84", metal	5	0.105
LTN70P400	400mm/15.75", metal	5	0.167
LTN70P100T	100mm/3.94", metal with threaded end	5	0.039
LTN70P250T	250mm/9.84", metal with threaded end	5	0.100
LTN70P400T	400mm/15.75", metal with threaded end	5	0.163

- ❶ For light towers including both white light module and sound modules please check the wiring diagram at page 8-17.
- ❷ For fixing base LTN70BP2 the extension tube LTNP... without threaded end has to be used.
- ❸ Extension tubes with threaded end LTNP...T have to be used for all the fixing bases except for LTN70BP2.

General characteristics

The signal towers can be assembled by stacking up to 5 light modules or 4 light modules and 1 sound module.

Technical characteristics

- Maximum operational voltage: 26.4VDC - 240VAC
- Light, sound and wiring modules consumption:
 - light modules: 1.2VA
 - sound modules: 1.7VA
 - wiring modules: 1VA
- Number of stackable modules: 5
- Connections: screw clamp terminals and conductor section 0.25...1.5mm²/AWG16...24
- Operating temperature: -30...+50°C
- IEC degree of protection: IP65 for wiring modules, light modules, top cover and sound module LTN70MSL.

Certifications and compliance

Certifications obtained: cULus, EAC.
Compliant with standards: IEC/EN/BS 60947-5-1, IEC/EN/BS 60947-1, UL508, CSA C22.2 n° 14.

Combinations

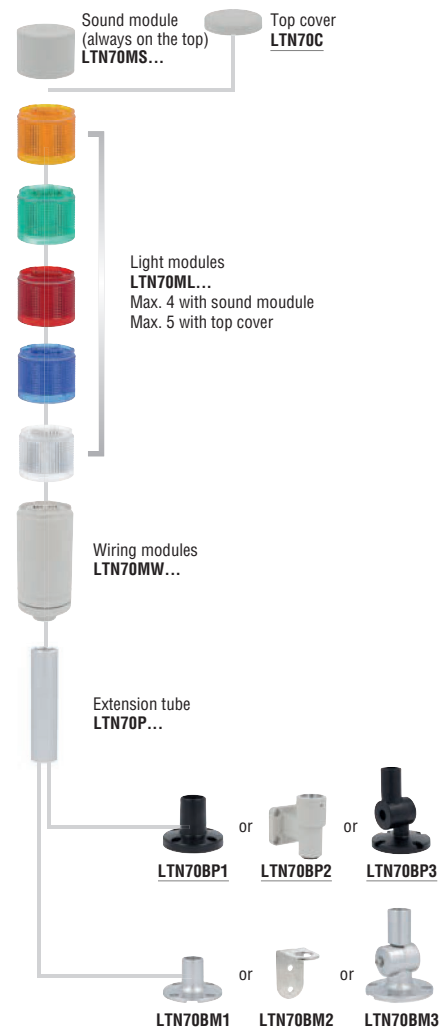

Multicoloured signal towers Ø70mm/2.75" 8LT73... type



8LT73S...



8LT73B...

Order code	Description	Qty per pkg	Wt
		n°	[kg]
Steady light and pulsed or continuous sound multicoloured light modules. Built-in LED circuit ❶.			
8LT73B9A	Green, orange, red, 24VDC	1	0.090
8LT73S2B9A	Green, orange, red, with continuous or pulsed sound 24VDC	1	0.200
8LT73B9B	Blue, orange, red, 24VDC	1	0.090
8LT73S2B9B	Blue, orange, red, with continuous or pulsed sound 24VDC	1	0.200

❶ For accessories and spare parts see page 8-9 and 10.

General characteristics

The multicoloured signal towers incorporate the possibility of up to 3 different colours in a single light module. In the event of two or more alarms, the multicoloured module lights up in alternating colours corresponding to the event. The multicoloured module must always be placed last, at the top of the tower, should it be used together with light modules 8LT7EL... 8LT7GL... or 8LT7FL...

Technical characteristics

- Supply voltage: 24VDC (±10%)
- Light and sound module consumption: 90mA
- Sound intensity: 90dB/1m
- Material: polycarbonate
- Number of stackable elements: 4 with 8LT73B modules, 1 with 8LT73S modules
- Connections: screw clamp terminals and maximum conductor section 1.5mm²/16AWG
- Tightening torque: 0.5Nm/4.5lb.in
- Operating temperature: -20...+50 °C
- IEC degree of protection: IP65.

Certifications and compliance

Certifications obtained: cULus, EAC.
Compliant with standards: IEC/EN/BS 60947-5-1, IEC/EN/BS 60947-1, UL508, CSA C22.2 n° 14.

Combinations

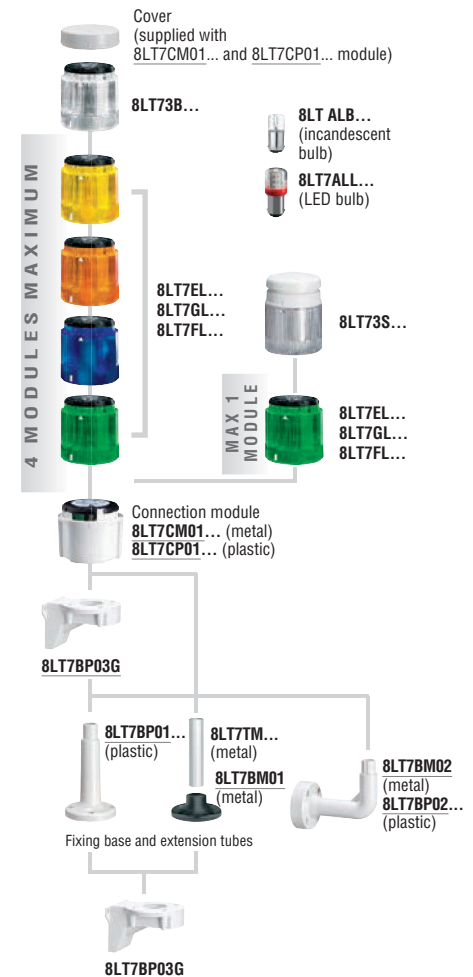

For accessories and spare parts see page 8-9 and 10.

Signal towers Ø70mm/2.75", 8LT7... series



8LT7EL ...
8LT7GL ...
8LT7FL ...

Order code	Description	Qty per pkg	Wt
		n°	[kg]

Steady light modules. BA15d fitting ❶.
Bulb (8LT7ALB... and 8LT7ALL...) not included.

8LT7EL1	Orange	1	0.082
8LT7EL3	Green	1	0.082
8LT7EL4	Red	1	0.082
8LT7EL5	Yellow	1	0.082
8LT7EL6	Blue	1	0.082
8LT7EL8	White	1	0.082

Blinking light modules. BA15d fitting ❶.
Bulb (8LT7ALB... and 8LT7ALL...) not included.

8LT7GLB1	Orange, 24VAC/DC	1	0.083
8LT7GLB3	Green, 24VAC/DC	1	0.083
8LT7GLB4	Red, 24VAC/DC	1	0.083
8LT7GLB5	Yellow, 24VAC/DC	1	0.083
8LT7GLB6	Blue, 24VAC/DC	1	0.083
8LT7GLB8	White, 24VAC/DC	1	0.083
8LT7GLE1	Orange, 110...120VAC	1	0.083
8LT7GLE3	Green, 110...120VAC	1	0.083
8LT7GLE4	Red, 110...120VAC	1	0.083
8LT7GLE5	Yellow, 110...120VAC	1	0.083
8LT7GLE6	Blue, 110...120VAC	1	0.083
8LT7GLE8	White, 110...120VAC	1	0.083
8LT7GLM1	Orange, 230...240VAC	1	0.083
8LT7GLM3	Green, 230...240VAC	1	0.083
8LT7GLM4	Red, 230...240VAC	1	0.083
8LT7GLM5	Yellow, 230...240VAC	1	0.083
8LT7GLM6	Blue, 230...240VAC	1	0.083
8LT7GLM8	White, 230...240VAC	1	0.083

Flash light modules. With 4-joule xenon bulb ❶.

8LT7FLB1	Orange, 24VAC/DC	1	0.092
8LT7FLB3	Green, 24VAC/DC	1	0.092
8LT7FLB4	Red, 24VAC/DC	1	0.092
8LT7FLB5	Yellow, 24VAC/DC	1	0.092
8LT7FLB6	Blue, 24VAC/DC	1	0.092
8LT7FLB8	White, 24VAC/DC	1	0.092
8LT7FLE1	Orange, 110...120VAC	1	0.092
8LT7FLE3	Green, 110...120VAC	1	0.092
8LT7FLE4	Red, 110...120VAC	1	0.092
8LT7FLE5	Yellow, 110...120VAC	1	0.092
8LT7FLE6	Blue, 110...120VAC	1	0.092
8LT7FLE8	White, 110...120VAC	1	0.092
8LT7FLM1	Orange, 230...240VAC	1	0.092
8LT7FLM3	Green, 230...240VAC	1	0.092
8LT7FLM4	Red, 230...240VAC	1	0.092
8LT7FLM5	Yellow, 230...240VAC	1	0.092
8LT7FLM6	Blue, 230...240VAC	1	0.092
8LT7FLM8	White, 230...240VAC	1	0.092

❶ For accessories and spare parts see page 8-9 and 10.

General characteristics

Signal towers are fundamental elements in manufacturing processes for the visual and audible signalling of the system status.

The signal towers can be assembled by stacking up to 7 modules, in the following sequence, starting from the top: red, yellow, orange, blue, green and white.

Technical characteristics

- Maximum operational voltage: 250VAC/DC
- Flash light and sound module consumption:
 - 8LT7FLB... in AC: 135mA
 - 8LT7FLB... in DC: 75mA
 - 8LT7FLE... 20mA
 - 8LT7FLM... 15mA
- Material: polycarbonate or anodised aluminium
- Number of stackable modules: 7
- Connections: screw clamp terminals and maximum conductor section 1.5mm²/16AWG
- Tightening torque: 0.5Nm/4.5lb.in
- Operating temperature: -20...+50°C (12VAC max. up to +40°C)
- IEC degree of protection: IP65.

Certifications and compliance

Certifications obtained: UL Listed, for USA and Canada (cULus - file E318016) as Power Circuit and motor-mounted Apparatus - Stackable tower lights, EAC. Compliant with standards: IEC/EN/BS 60947-5-1, IEC/EN/BS 60947-1, UL508, CSA C22.2 n° 14.

Combinations

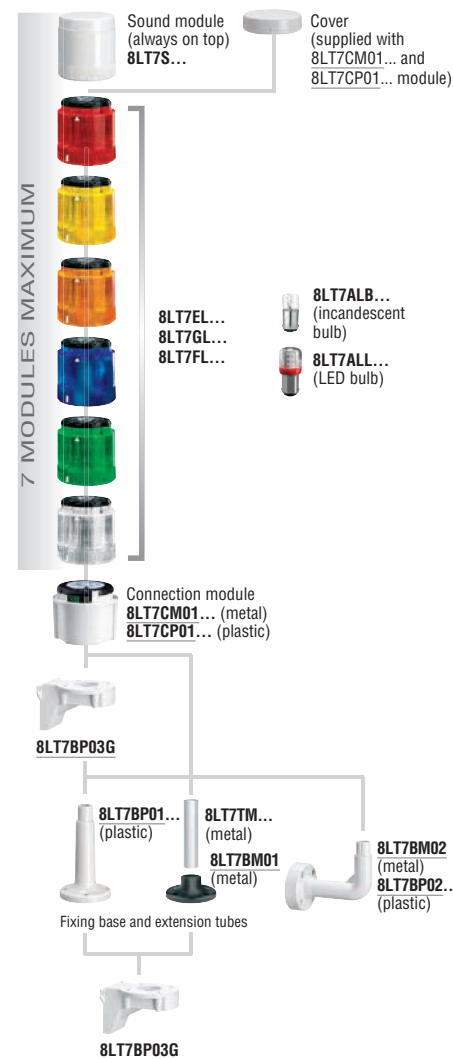

For accessories and spare parts see page 8-9 and 10.

Signal towers Ø70mm/2.75", 8LT7... series



8LT7S...G



8LT7S...



8LT7CM01G
8LT7CP01G



8LT7CM01
8LT7CP01

Order code	Description	Qty per pkg	Wt	
		n°	[kg]	
Pulsed or continuous sound modules, grey colour ❶.				
8LT7S0BG	24VAC/DC, pulsed (90dB). IP54	1	0.240	
8LT7S1BG	24AC/DC, 16 sounds select. (max. 90dB). IP65	1	0.240	
8LT7S2BG	24VAC/DC	puls. sound (78dB)❷	1	0.240
8LT7S2EG	110...120VAC	or continuous (75dB)❸. IP65	1	0.240
8LT7S2MG	230...240VAC		1	0.240
Pulsed or continuous sound modules, black colour ❶.				
8LT7S0B	24VAC/DC, pulsed (90dB). IP54	1	0.240	
8LT7S1B	24AC/DC, 16 sounds select. (max. 90dB). IP65	1	0.240	
8LT7S2B	24VAC/DC	puls. sound (78dB)❷	1	0.240
8LT7S2E	110...120VAC	or continuous (75dB)❸. IP65	1	0.240
8LT7S2M	230...240VAC		1	0.240
Connection modules and cover (bottom entry).				
8LT7CP01G	For plastic tubes, grey colour	1	0.110	
8LT7CM01G	For metal tubes, grey colour	1	0.120	
8LT7CP01	For plastic tubes, black colour	1	0.110	
8LT7CM01	For metal tubes, black colour	1	0.120	

❶ For accessories and spare parts see page 8-9 and 10.

❷ For 8LT7S2B... = 84.5dB.

❸ For 8LT7S2B... = 82.6dB.

Technical characteristics

- The sound module must always be placed last, on the top of the tower (it cannot be fitted with an 8LT73... multicoloured module).
- Sound module consumption:
 - 8LT7S0B...: 25mA
 - 8LT7S1B...: 40mA
 - 8LT7S2B...: 200mA
 - 8LT7S2E...: 40mA
 - 8LT7S2M...: 30mA
- Material: polycarbonate
- Max. number of sound modules: 1 per tower
- Connections: screw clamp terminals and maximum conductor section 1.5mm²/16AWG
- Tightening torque: 0.5Nm/4.5lb.in
- Operating temperature: -20...+50°C (12VAC max. up to +40°C)
- IEC degree of protection: IP65 (IP54 if 8LT7S0B... sound module used).

Certifications and compliance

Certifications obtained: UL Listed, for USA and Canada (cULus - file E318016) as Power Circuit and motor-mounted Apparatus - Stackable tower lights, EAC. Compliant with standards: IEC/EN/BS 60947-5-1, IEC/EN/BS 60947-1, UL508, CSA C22.2 n° 14.

Combinations

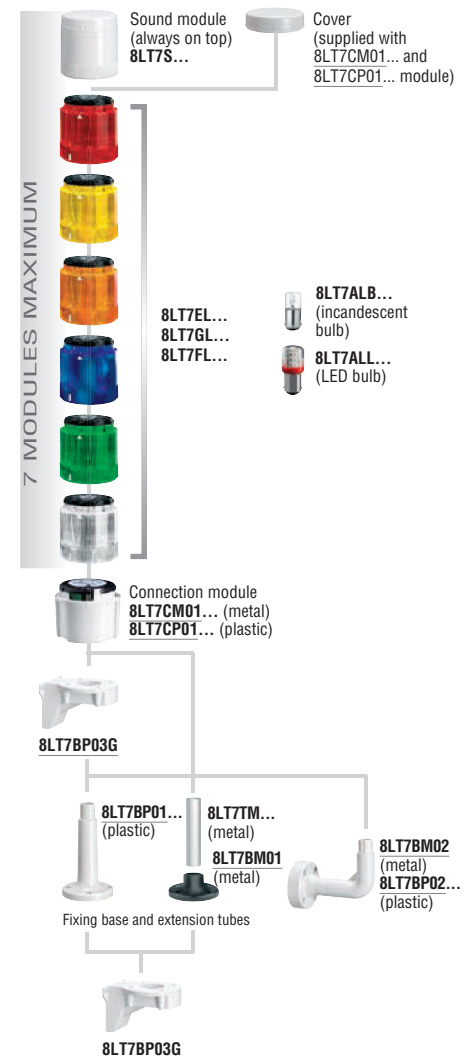

For accessories and spare parts see page 8-9 and 10.

Signal beacons Ø62mm/2.44", 8LB... series



8LB6EL...
8LB6GL...
8LB6S2...

Order code	Description	Qty per pkg	Wt
		n°	[kg]

Steady light modules. BA15d fitting.
Bulb (8LT7ALB... and 8LT7ALL...) not included.

8LB6EL1	Orange	1	0.060
8LB6EL3	Green	1	0.060
8LB6EL4	Red	1	0.060
8LB6EL5	Yellow	1	0.060
8LB6EL6	Blue	1	0.060
8LB6EL8	White	1	0.060

Blinking or steady light modules. BA15d fitting.
Bulb (8LT7ALB... and 8LT7ALL...) not included.

8LB6GLB1	Orange, 12...48VAC/DC	1	0.060
8LB6GLB3	Green, 12...48VAC/DC	1	0.060
8LB6GLB4	Red, 12...48VAC/DC	1	0.060
8LB6GLB5	Yellow, 12...48VAC/DC	1	0.060
8LB6GLB6	Blue, 12...48VAC/DC	1	0.060
8LB6GLB8	White, 12...48VAC/DC	1	0.060
8LB6GLM1	Orange, 24...230VAC	1	0.060
8LB6GLM3	Green, 24...230VAC	1	0.060
8LB6GLM4	Red, 24...230VAC	1	0.060
8LB6GLM5	Yellow, 24...230VAC	1	0.060
8LB6GLM6	Blue, 24...230VAC	1	0.060
8LB6GLM8	White, 24...230VAC	1	0.060

Light and sound pulsed or continuous sound modules.
Bulb included.

8LB6S2B1	Orange, 24VAC/DC (80dB)	1	0.060
8LB6S2B3	Green, 24VAC/DC (80dB)	1	0.060
8LB6S2B4	Red, 24VAC/DC (80dB)	1	0.060
8LB6S2B5	Yellow, 24VAC/DC (80dB)	1	0.060
8LB6S2B6	Blue, 24VAC/DC (80dB)	1	0.060
8LB6S2B8	White, 24VAC/DC (80dB)	1	0.060

General characteristics

Signal beacons are fundamental elements in manufacturing processes for the visual and audible signalling of the system status.

Technical characteristics

- Maximum operational voltage: 250VAC/DC
- Sound module consumption: 8LB6S2...:150mA
- Material: polycarbonate
- Connections: screw clamp terminals and maximum conductor section 1.5mm²/16AWG
- Tightening torque: 0.5Nm/4.5lb.in
- Operating temperature: -20...+50°C
- IEC degree of protection: IP54 (IP30 if used with bases 8LB6BP04, 8LB6BP06, 8LB6BP08...).

Certifications and compliance

Certifications obtained: EAC.
Compliant with standards: IEC/EN/BS 60947-5-1, IEC/EN/BS 60947-1.

Combinations

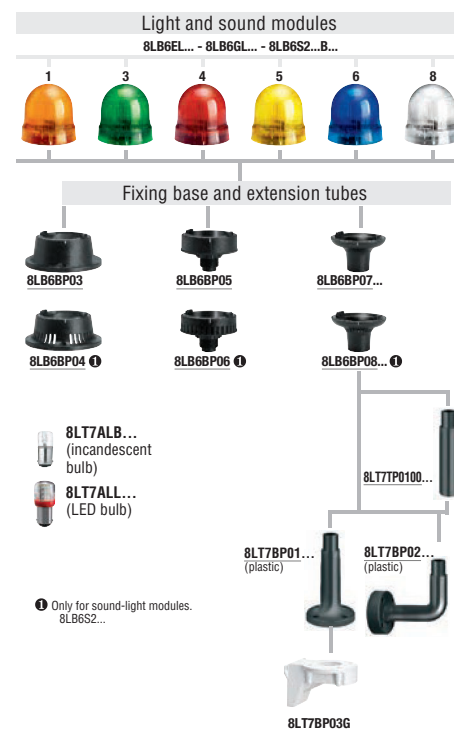

Plastic fixing bases and extension tubes for 8LT... and 8LB... series



8LT7BP01G



8LT7BP02



8LT7BP02G



8LT7BP02



8LT7BP03G



8LT7TP0100G



8LT7TP0100

Order code	Description	Qty per pkg	Wt [kg]
Plastic fixing bases.			
8LT7BP01G	Horizontal surface mount, plastic grey colour with 100mm/3.94" extension	1	0.045
8LT7BP02G	Vertical wall mount, plastic, grey colour	1	0.078
8LT7BP03G	90° vertical wall mount, grey colour	1	0.080
8LT7BP01	Horizontal surface mount, plastic, black colour with 100mm/3.94" extension	1	0.045
8LT7BP02	Vertical wall mount, plastic, black colour	1	0.078
Extension tubes for plastic bases.			
8LT7TP0100G	100mm/3.94", grey colour	1	0.029
8LT7TP0100	100mm/3.94", black colour	1	0.029

General characteristics

The assembly operation for the signal towers is simple and fast and does not require the use of any tools. The bayonet fitting with slight pressure and simple circular movement makes it possible to mount each element on top of the previous one. There are specific white marks to indicate the correct alignment.

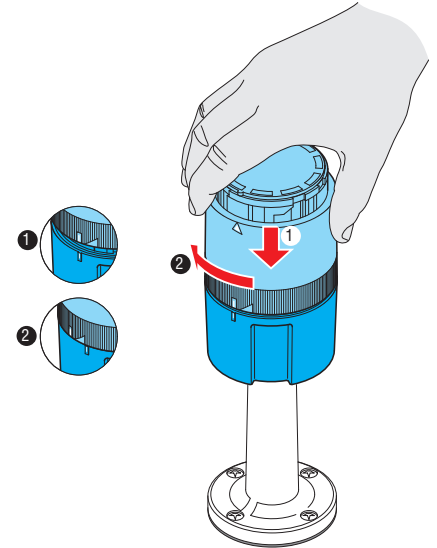

Bulbs for 8LT... and 8LB... series



8LT7ALB...



8LT7ALL...

Order code	Description	Qty per pkg	Wt
		n°	[kg]
Incandescent bulbs, 5W, BA15d fitting.			
8LT7ALBA	12VAC/DC	10	0.006
8LT7ALBB	24VAC/DC	10	0.006
8LT7ALBE	130VAC/DC	10	0.006
8LT7ALBM	260VAC/DC	10	0.006
LED bulbs, BA15d fitting.			
8LT7ALLA4	Red, 12VAC/DC	10	0.010
8LT7ALLA8	White, 12VAC/DC	10	0.010
8LT7ALLB3	Green, 24VAC/DC	10	0.010
8LT7ALLB4	Red, 24VAC/DC	10	0.010
8LT7ALLB5❶	Yellow/Orange, 24VAC/DC	10	0.010
8LT7ALLB6	Blue, 24VAC/DC	10	0.010
8LT7ALLB8	White, 24VAC/DC	10	0.010
8LT7ALLE3	Green, 110...120VAC	10	0.010
8LT7ALLE4	Red, 110...120VAC	10	0.010
8LT7ALLE5❶	Yellow/Orange, 110...120VAC	10	0.010
8LT7ALLE6	Blue, 110...120VAC	10	0.010
8LT7ALLE8	White, 110...120VAC	10	0.010
8LT7ALLM3	Green, 230...240VAC	10	0.010
8LT7ALLM4	Red, 230...240VAC	10	0.010
8LT7ALLM5❶	Yellow/Orange, 230...240VAC	10	0.010
8LT7ALLM6	Blue, 230...240VAC	10	0.010
8LT7ALLM8	White, 230...240VAC	10	0.010

❶ Used with yellow or orange light modules.

Technical characteristics

- Consumption of bulb fitted on light modules:
 - 8LT7ALBA: 420mA
 - 8LT7ALBB: 210mA
 - 8LT7ALBE: 43mA
 - 8LT7ALBM: 22mA
 - 8LT7ALLA...: <60mA
 - 8LT7ALLB...: <30mA
 - 8LT7ALLE...: <20mA
 - 8LT7ALLM...: <20mA.

Compliance

Compliant with standards: IEC/EN/BS 60947-5-1, IEC/EN/BS 60947-1, UL508, CSA C22.2 n° 14.

Metal fixing bases and extension tube for multicoloured signal towers Ø70mm/2.75" and signal towers assembled Ø45mm/1.77"



8LT7BM01



8LT7BM02



8LT7TM

Order code	Description	Qty per pkg	Wt
		n°	[kg]
Metal fixing bases.			
8LT7BM01	Horizontal surface mount, metal, black	1	0.099
8LT7BM02	Wall mount, metal	1	0.184
Extension tubes for metal bases, anodised aluminium.			
8LT7TM0100	120mm/4.72"	1	0.016
8LT7TM0200	220mm/8.66"	1	0.024
8LT7TM0300	320mm/12.60"	1	0.048
8LT7TM0400	420mm/16.53"	1	0.064
8LT7TM0500	520mm/20.74"	1	0.080
8LT7TM1000	1020mm/40.16"	1	0.160

Metal fixing bases for 8LB... series



8LB6BP07G



8LB6BP03



8LB6BP05



8LB6BP07



8LB6BP08G



8LB6BP04



8LB6BP06



8LB6BP08

Order code	Description	Qty per pkg n°	Wt [kg]
Fixing bases for light modules.			
8LB6BP07G	For extension connection, plastic, grey. Use with fixing bases 8LT7BP01G and 8LT7BP02G	1	0.020
8LB6BP03	For horizontal mount, plastic, black	1	0.040
8LB6BP05	For hole Ø22mm/0.87", plastic, black	1	0.040
8LB6BP07	For extension connection, plastic, black. Use with fixing bases 8LT7BP01 and 8LT7BP02	1	0.020
Fixing bases for light and sound modules.			
8LB6BP08G	For extension connection, plastic, grey. Use with fixing bases 8LT7BP01G and 8LT7BP02G	1	0.020
8LB6BP04	For horizontal mount, plastic, black	1	0.040
8LB6BP06	For hole Ø22mm/0.87", plastic, black	1	0.040
8LB6BP08	For extension connection, plastic, black. Use with fixing bases 8LT7BP01 and 8LT7BP02	1	0.020

General characteristics

The assembly operation of the light and sound modules is simple and fast and does not require the use of any tools. There are specific white marks to indicate the correct alignment.

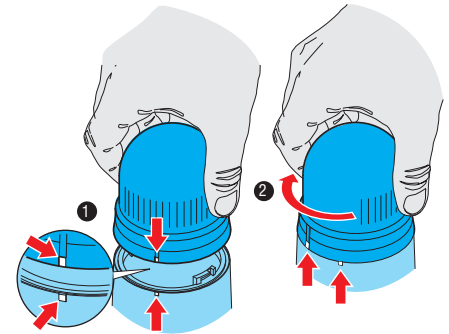

8 Signal towers and beacons

Dimensions [mm (in)]

SIGNAL TOWERS READY ASSEMBLED Ø45mm/1.77"

8LT4K02BG

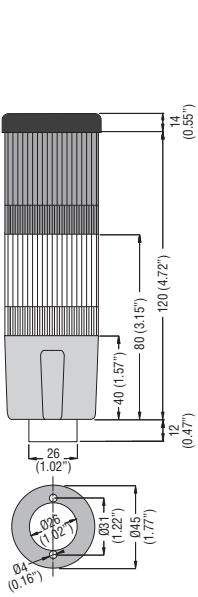

8LT4K03BG

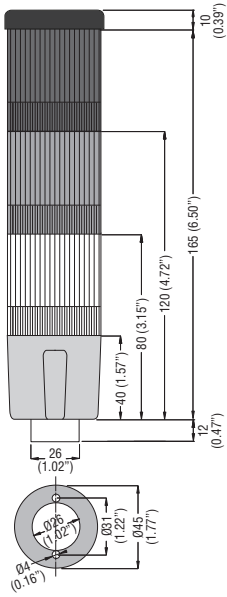

8LT4K04BG

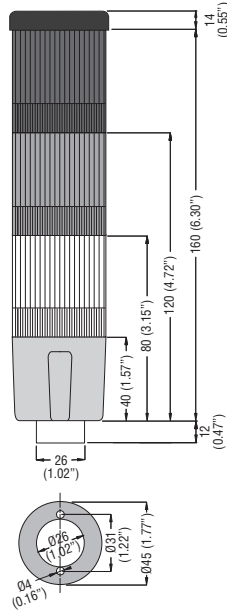

8LT4K05BG

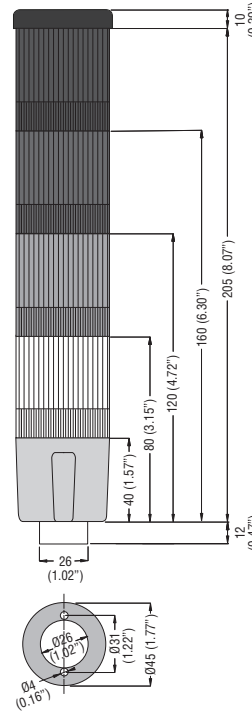

8LT4K06BG

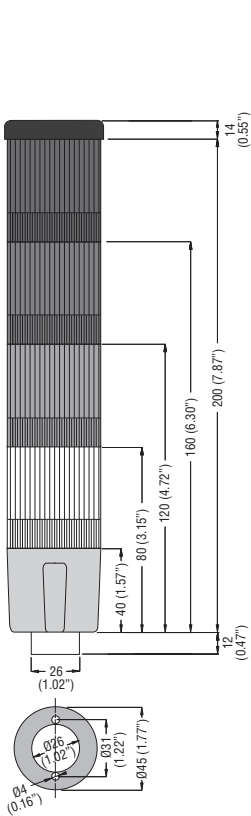

8LT4K07BG

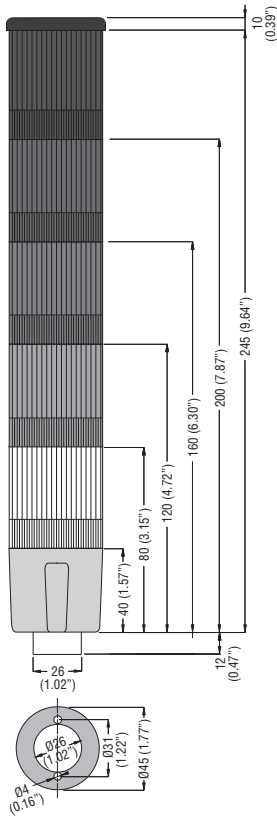

8LT4K08BG

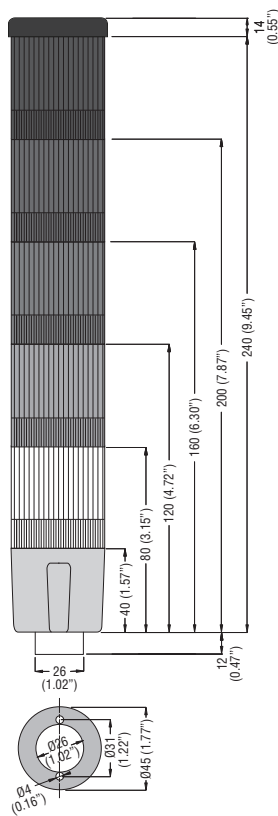

8LT4K09BG

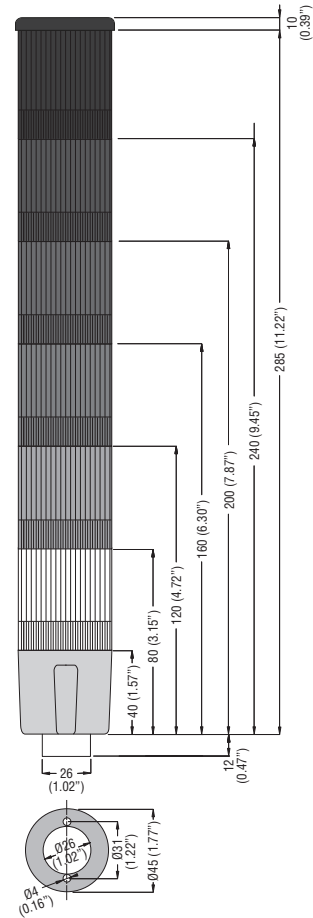

SIGNAL TOWERS Ø50mm/1.97"

Top cover
LTN50C

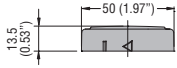

Sound modules
LTN50MSH

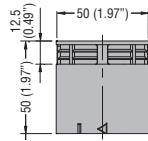

LTN50MSL

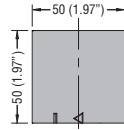

Light modules
LTN50ML

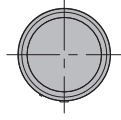
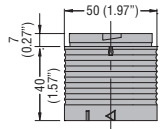

Wiring modules
LTN50MW230

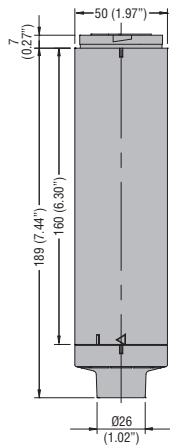

LTN50MW024

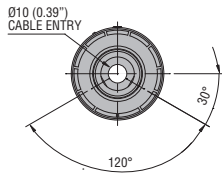
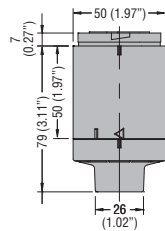

Extension tubes
LTP50P...

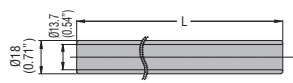

Type	L (mm/in)
LTP50P100	100 (3.94")
LTP50P250	250 (9.84")
LTP50P400	400 (15.75")

LTN50P...T

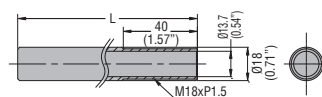

Type	L (mm/in)
LTP50P100T	100 (3.94")
LTP50P250T	250 (9.84")
LTP50P400T	400 (15.75")

Fixing bases
LTN50BP1

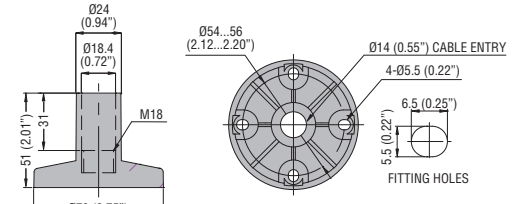

LTN50P2

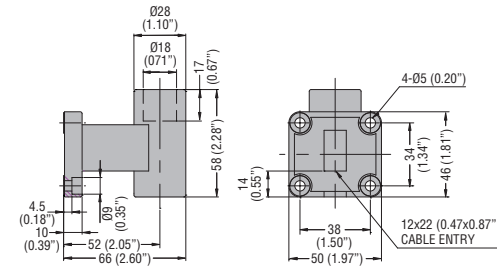

LTN50BP3

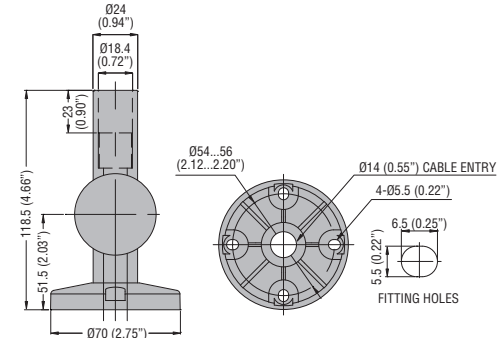

LTN50BM1

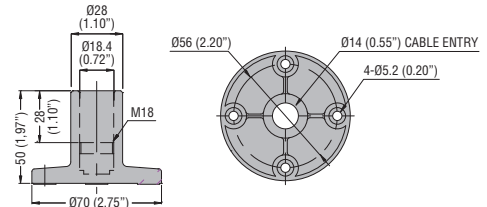

LTN50M2

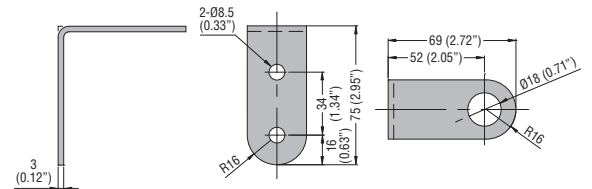

LTN50BM3

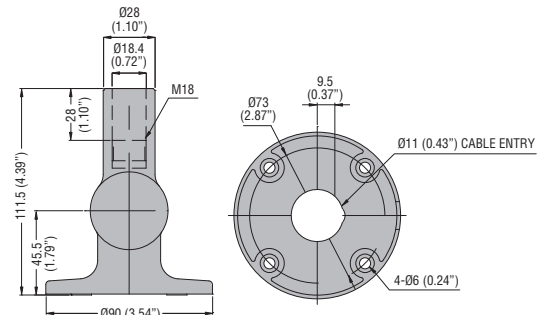

8 Signal towers and beacons

Dimensions [mm (in)]

SIGNAL TOWERS Ø70mm/2.75"

Top cover LTN70C

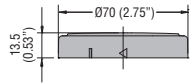

Sound modules LTN70MSH

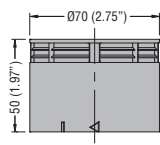

LTN70MSL

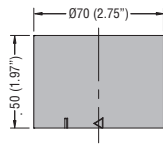

Light modules LTN70ML

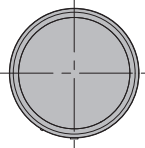
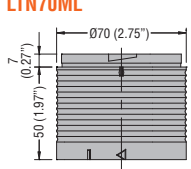

Wing modules LTN70MW230

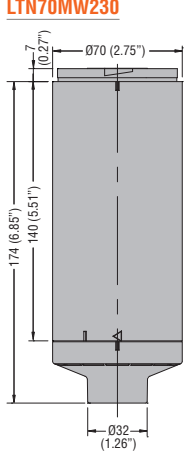

LTN70MW024

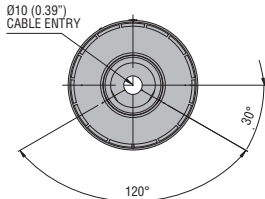
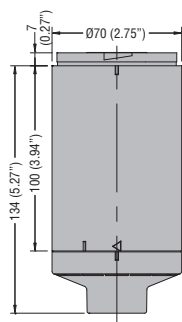

Extension tubes LTN70P...

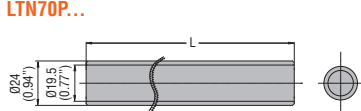

Type	L (mm)
LTP70P100	100 (3.94")
LTP70P250	250 (9.84")
LTP70P400	400 (15.75")

LTN70P...T

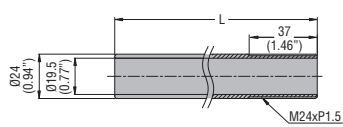

Type	L (mm)
LTP70P100T	100 (3.94")
LTP70P250T	250 (9.84")
LTP70P400T	400 (15.75")

Fixing bases LTN70BP1

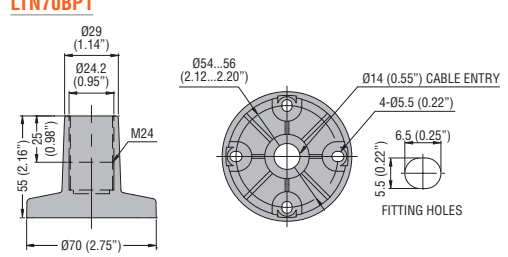

LTN70P2

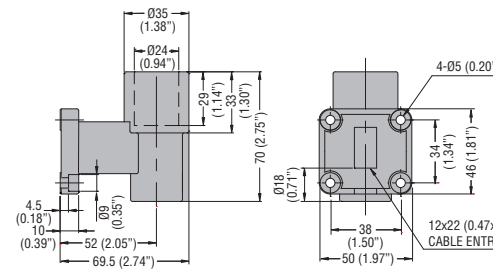

LTN70BP3

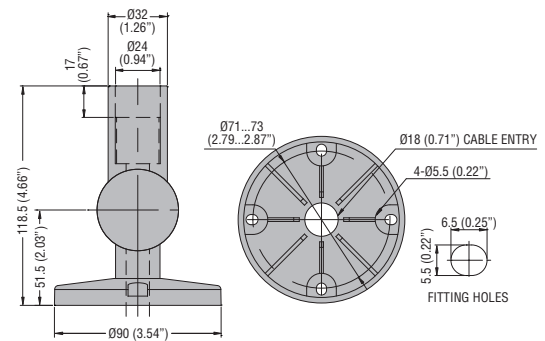

LTN70BM1

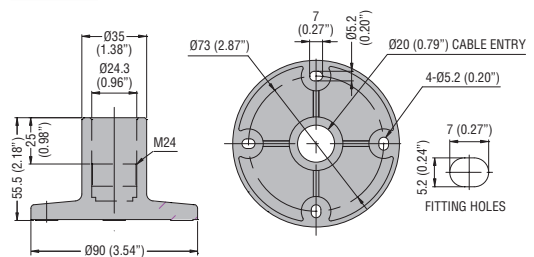

LTN70M2

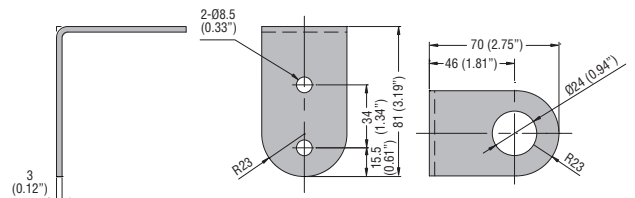

LTN70BM3

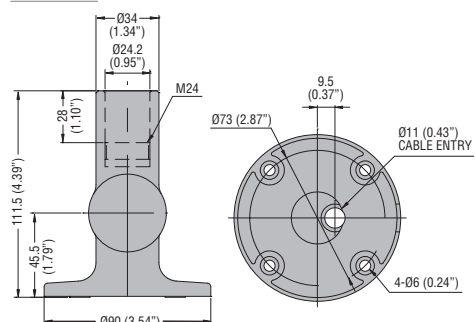

MULTICOLOURED SIGNAL TOWERS Ø70mm/2.75" AND SIGNAL TOWERS Ø70mm/2.75" 8LT... SERIES

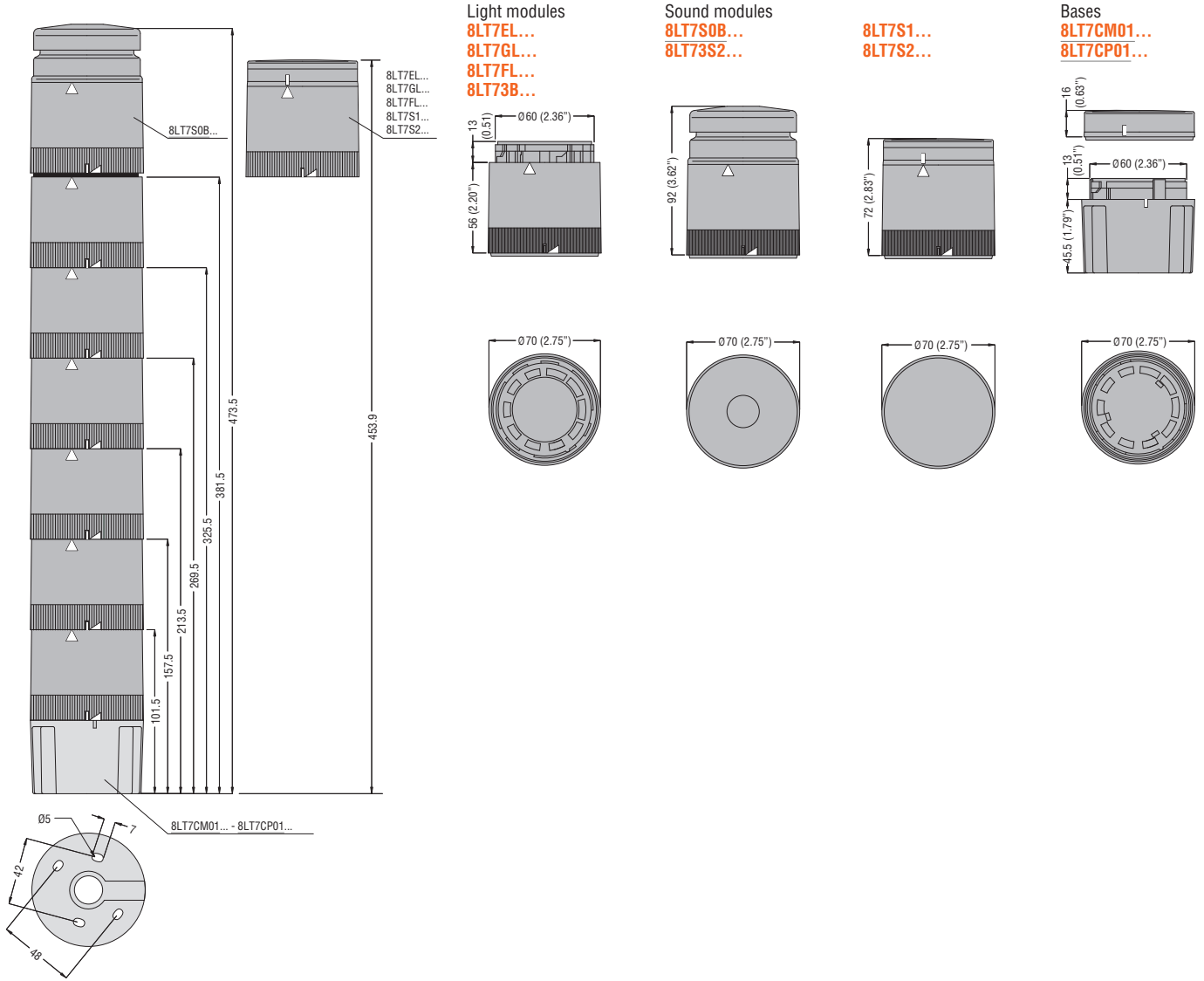

SIGNAL BEACONS Ø62mm/2.44"

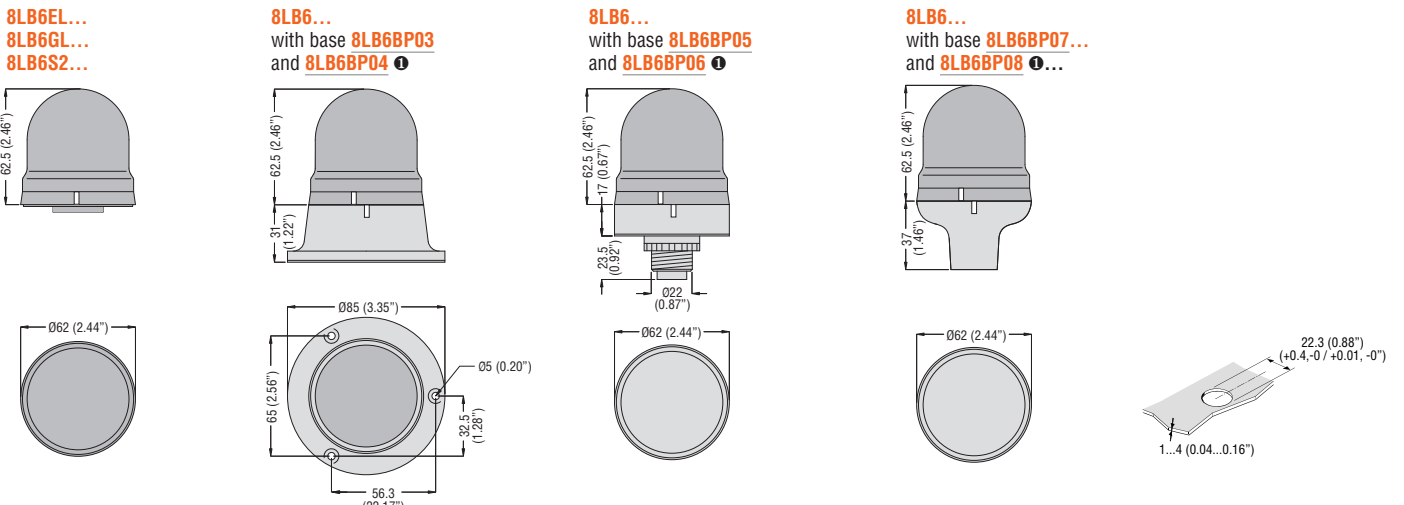

FIXING BASES AND EXTENSIONS FOR 8LT... SERIES

8LT7BP01...

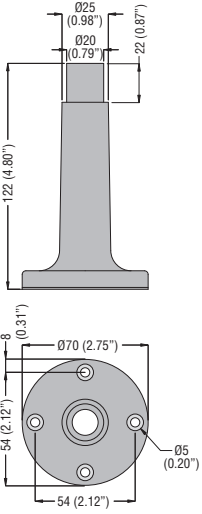

8LT7BP02...

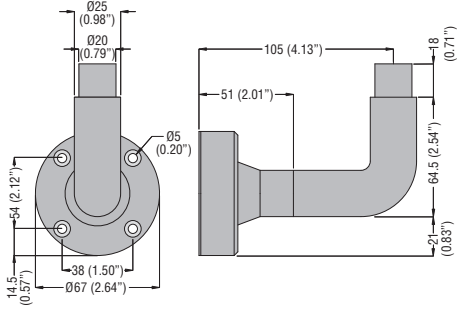

8LT7BM01

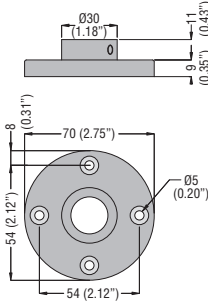

8LT7BM02

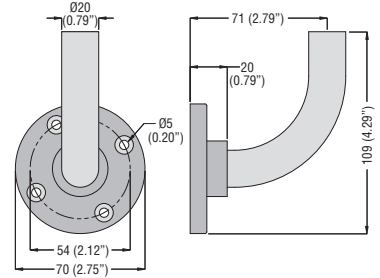

8LT7TP0100...

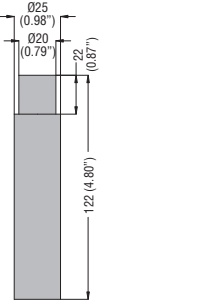

8LT7TM...

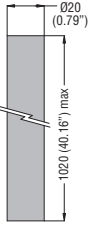

8LT7BP03G

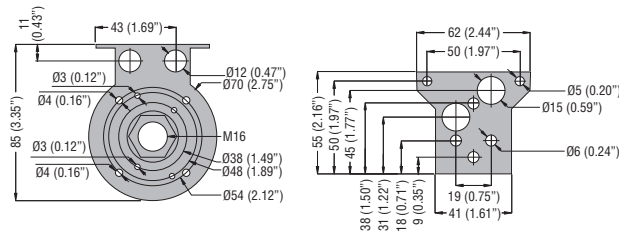

SIGNAL TOWERS ASSEMBLED Ø45mm/1.77"
8LT4...

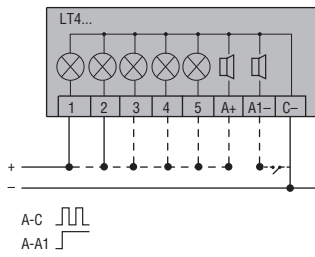

SIGNAL TOWERS Ø50mm/1.97" AND Ø70mm/2.75" LTN... SERIES

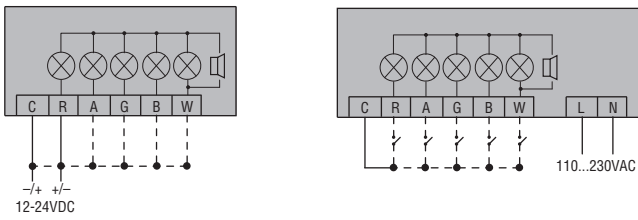

MULTICOLOURED SIGNAL TOWERS Ø70mm/2.75"
 AND SIGNAL TOWERS Ø70mm/2.75"
8LT7...

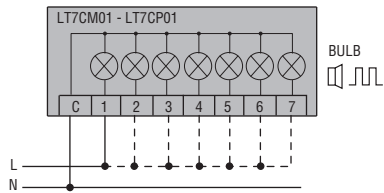

Connect terminals C and 1 as indicated to power the first module.
 If other modules are fitted, the respective terminals must be connected accordingly.

SIGNAL BEACONS Ø62mm/2.44"
8LB6...

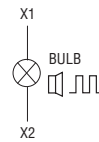

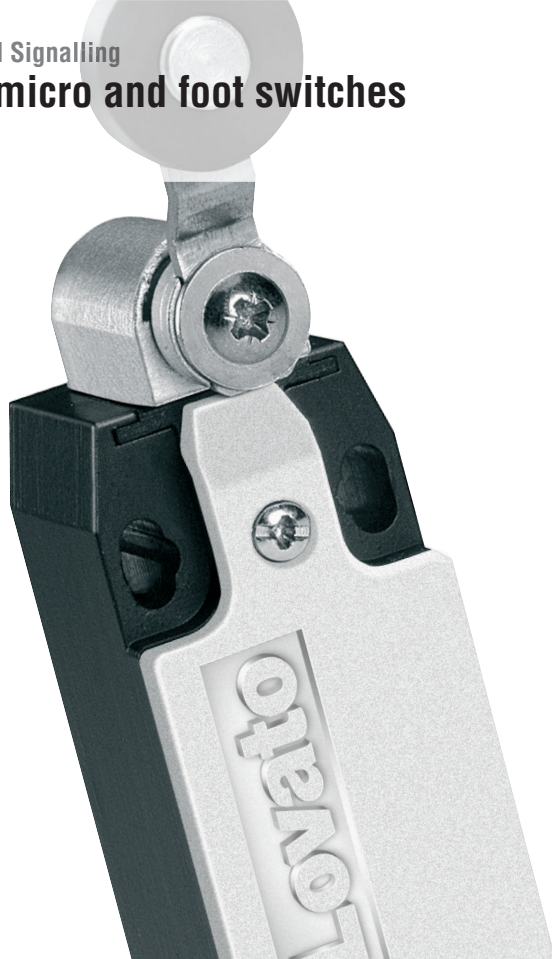

- Dimensions compatible to EN/BS 50047
- Direct opening action of NC contacts
- Extensive range of operating heads
- Versions complete with interchangeable and rotatable heads
- Versions with removable and interchangeable auxiliary contact blocks.

	SEC. - PAGE
Metal and plastic limit switches, K series (dimensions to/compatible to EN/BS 50047)	
Top push rod plunger	9 - 2
Top roller push plunger	9 - 3
Roller centre push lever	9 - 4
Roller side push lever	9 - 5
Roller lever	9 - 6
Adjustable roller lever	9 - 8
Ceramic rod lever	9 - 10
Adjustable rod lever	9 - 11
Wobble stick, omnidirectional	9 - 12
Hinge operating	9 - 13
Slotted lever	9 - 14
Key operated	9 - 15
Accessories and spare parts	9 - 16
Prewired metal limit switches	9 - 18
Metal limit switches, PL series	
Top push rod plunger, top roller push plunger, roller centre push lever	9 - 19
Latch and manual release	9 - 20
Manual reload and magnetic release	9 - 20
Bi-directional	9 - 20
Rope-pull lever limit switches for normal stopping	9 - 21
Rope-pull lever limit switches for emergency stopping (ISO 13850 compliant)	9 - 23
Safety switches with solenoid and separate actuator	9 - 24
Plastic micro switches	9 - 26
Foot switches	9 - 27
Dimensions	9 - 28
Wiring diagrams	9 - 35



Page 9-2

PLASTIC AND METAL LIMIT SWITCHES K SERIES

- Dimensions to EN/BS 50047 standards for KB and KM types
- Dimensions compatible to EN/BS 50047 for KC and KN types
- Self-extinguishing polymer thermoplastic housing (KB-KC types)
- Aluminium-zinc alloy housing (KM-KN types)
- Removable and interchangeable auxiliary contact blocks
- Bi-directional versions
- Unique fixing mechanism of operating head
- IEC degree of protection IP65
- M20 cable entry; PG13.5 or 1/2 NPT entry available.



Page 9-18

PREWIRED METAL LIMIT SWITCHES

- Dimensions to EN/BS 50047 standards
- 2 metre long cable
- IEC degree of protection IP67.



Page 9-19

METAL LIMIT SWITCHES PL SERIES

- Aluminium-zinc alloy housing
- Maximum of 2 auxiliary contacts
- IEC degree of protection IP40 and IP65
- PG11 cable entry.



Page 9-21

ROPE-PULL LEVER LIMIT SWITCHES FOR NORMAL STOPPING

- Self-extinguishing polymer thermoplastic housing
- Aluminium-zinc alloy housing
- IEC degree of protection IP40, IP65 and IP66
- PG11 and PG13.5 cable entry.



Page 9-23

ROPE-PULL LEVER LIMIT SWITCHES FOR EMERGENCY STOPPING

- Compliant to ISO 13850 standards
- IEC degree of protection IP65 and IP66
- PG11 and PG13.5 cable entry.



Page 9-24

SAFETY SWITCHES WITH SOLENOID AND SEPARATE ACTUATOR

- Actuator locked by solenoid
- For safety applications up to:
 - Safety integrity level (SIL), category 3: according to EN/BS 62061
 - PLe according to EN/BS ISO 13849-1
- Interlock with mechanical lock Type 2 according to EN/BS ISO 14119
- Self-extinguishing polymer thermoplastic housing and actuator head
- IEC degree of protection IP65
- Three threaded conduit entries M20.



Page 9-26

PLASTIC MICRO SWITCHES

- Polymer thermoplastic housing
- Changeover contact switch
- IEC degree of protection IP00 or IP20.



Page 9-27

FOOT SWITCHES

- Versions with or without protection cover
- Self-extinguishing polymer thermoplastic housing
- Aluminium-zinc alloy housing
- IEC degree of protection IP54 and IP65
- M20 cable entry.

9 Limit, micro and foot switches

Limit switches, K series. One bottom cable entry. Dimensions to EN/BS 50047
Two side cable entries. Dimensions compatible to EN/BS 50047

Top push rod plunger



KBA... - KMA...

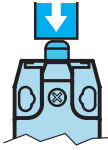

KCA... - KNA...

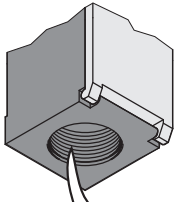

M20 CABLE ENTRY

For types with PG13.5 cable entry, add the letter P at the end of the order code while for 1/2 NPT, add N. E.g. KBA1S11P - KBA1S11N

Order code Plastic body	Metal body	Contacts	Plunger material	Qty per pkg n°	Wt [kg]
One bottom cable entry. Dimensions to EN/BS 50047.					
KBA1S11	KMA1S11	1NO+1NC Snap actionⓈ	Metal	5	Ⓢ
KBA1S02	KMA1S02	2NC Snap actionⓈ	Metal	5	Ⓢ
KBA1A11	KMA1A11	1NO+1NC Slow action make before breakⓈ	Metal	5	Ⓢ
KBA1L11	KMA1L11	1NO+1NC Slow actionⓈ	Metal	5	Ⓢ
KBA1L02	KMA1L02	2NC Slow actionⓈ	Metal	5	Ⓢ
KBA1L20	KMA1L20	2NO Slow action	Metal	5	Ⓢ
KBA1L12	KMA1L12	1NO+2NC Slow actionⓈ	Metal	5	Ⓢ
KBA1L21	KMA1L21	2NO+1NC Slow actionⓈ	Metal	5	Ⓢ
KBA1L03	KMA1L03	3NC Slow actionⓈ	Metal	5	Ⓢ

Two side cable entries. Dimensions compatible to EN/BS 50047.					
KCA1S11	KNA1S11	1NO+1NC Snap actionⓈ	Metal	5	Ⓢ
KCA1S02	KNA1S02	2NC Snap actionⓈ	Metal	5	Ⓢ
KCA1A11	KNA1A11	1NO+1NC Slow action make before breakⓈ	Metal	5	Ⓢ
KCA1L11	KNA1L11	1NO+1NC Slow actionⓈ	Metal	5	Ⓢ
KCA1L02	KNA1L02	2NC Slow actionⓈ	Metal	5	Ⓢ
KCA1L20	KNA1L20	2NO Slow action	Metal	5	Ⓢ

Ⓢ Direct (positive) opening action Ⓢ; safety function according to IEC/EN/BS 60947-5-1.
Ⓢ Consult Technical support for information; see contact details on inside cover.

General characteristics

The LOVATO Electric limit switches have been designed to satisfy requirements comprising quick installation, easy wiring, simple setup, modularity, sturdiness and constant reliability.

The body cover is hinged at the bottom and removable. The innovative locking bayonet mechanism permits to remove and reposition the operating head in the required configuration with no tools. The auxiliary contact blocks are removable assuring remarkable wiring ease.

Operational characteristics

- Maximum operating rate: 3600 cycles/h
- Switching speed: 0.5...1.5m/s
- Mechanical life: >10 million cycles
- IEC conventional thermal current Ith: 10A
- UL/CSA and IEC/EN/BS 60947-5-1 designation:
 - A600 Q300 for KB...-KC... types
 - A300 Q300 for KM...-KN... types
- IEC rated insulation voltage Ui:
 - 690VAC for KB...-KC... types
 - 440VAC for KM...-KN... types
- IEC rated impulse withstand voltage Uimp:
 - 6kV for KB...-KC... types
 - 4kV for KM...-KN... types
- Class II insulation for KB...-KC... only
- Contact resistance: <10mΩ
- Short-circuit backup protection: 10A gG/SC quick fuse
- Operators of aluminium-zinc alloy
- Housing:
 - KB...-KC... types: self-extinguishing double-insulation polymer thermoplastic
 - KM...-KN... types: aluminium-zinc alloy
- Cable entry: M20 standard supplied; PG13.5 and 1/2 NPT available (see the side note for details)
- Operating head fixing: locking bayonet insert
- Operating force: 5N / 1.1lb
- Cable connection: self-releasing screw terminal
- Tightening torque:
 - Switch fixing: 2.5Nm / 22.1lb.in
 - Contact terminals: 0.8Nm / 7lb.in
 - Body lid screw fixing: 0.8Nm / 7lb.in
- Conductor section: 1 or 2 2.5mm² max / 16-14AWG
- Ambient conditions:
 - Operating temperature: -25...+70°C
 - Storage temperature: -40...+70°C
 - Pollution degree: 3
 - IEC degree of protection: IP20 for terminals
 - IEC degree of protection: IP65 for body housing.

Certifications and compliance

Certifications obtained: UL Listed for USA and Canada (cULus - File E93601), as Auxiliary Devices - Limit switches; EAC, CCC.
Compliant with standards: EN/BS 50047, IEC/EN/BS 60947-1, IEC/EN/BS 60947-5-1, IEC/EN/BS 60204-1, UL508, CSA C22.2 n° 14.

- ▶ Forward travel of snap action contacts
- ◀ Return travel of snap action contacts

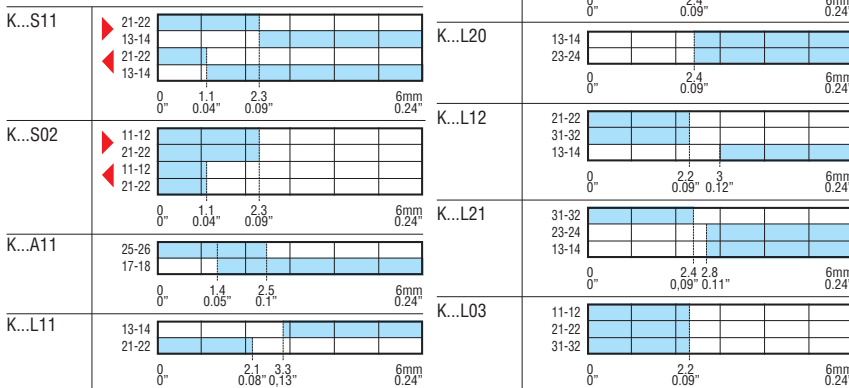

9 Limit, micro and foot switches

Limit switches, K series. One bottom cable entry. Dimensions to EN/BS 50047
Two side cable entries. Dimensions compatible to EN/BS 50047

Top roller push plunger



KBB... - KMB...

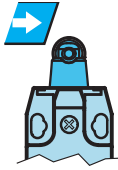

KCB... - KNB...

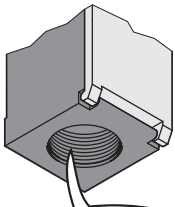

M20 CABLE ENTRY

For types with PG13.5 cable entry, add the letter P at the end of the order code while for 1/2 NPT, add N. E.g. KBB1S11P - KBB1S11N

Order code	Plastic body	Metal body	Contacts	Roller material	Qty per pkg	Wt [kg]
				Ø11x4	n°	[kg]

One bottom cable entry. Dimensions to EN/BS 50047.

KBB1S11	KMB1S11	1NO+1NC	Plastic	5	⊕
KBB2S11	KMB2S11	Snap action⊕	Metal	5	⊕
KBB1S02	KMB1S02	2NC	Plastic	5	⊕
KBB2S02	KMB2S02	Snap action⊕	Metal	5	⊕
KBB1A11	KMB1A11	1NO+1NC	Plastic	5	⊕
KBB2A11	KMB2A11	Slow action make before break⊕	Metal	5	⊕
KBB1L11	KMB1L11	1NO+1NC	Plastic	5	⊕
KBB2L11	KMB2L11	Slow action⊕	Metal	5	⊕
KBB1L02	KMB1L02	2NC	Plastic	5	⊕
KBB2L02	KMB2L02	Slow action⊕	Metal	5	⊕
KBB1L20	KMB1L20	2NO	Plastic	5	⊕
KBB2L20	KMB2L20	Slow action	Metal	5	⊕
KBB1L12	KMB1L12	1NO+2NC	Plastic	5	⊕
KBB2L12	KMB2L12	Slow action⊕	Metal	5	⊕
KBB1L21	KMB1L21	2NO+1NC	Plastic	5	⊕
KBB2L21	KMB2L21	Slow action⊕	Metal	5	⊕
KBB1L03	KMB1L03	3NC	Plastic	5	⊕
KBB2L03	KMB2L03	Slow action⊕	Metal	5	⊕

Two side cable entries. Dimensions compatible to EN/BS 50047.

KCB1S11	KNB1S11	1NO+1NC	Plastic	5	⊕
KCB2S11	KNB2S11	Snap action⊕	Metal	5	⊕
KCB1S02	KNB1S02	2NC	Plastic	5	⊕
KCB2S02	KNB2S02	Snap action⊕	Metal	5	⊕
KCB1A11	KNB1A11	1NO+1NC	Plastic	5	⊕
KCB2A11	KNB2A11	Slow action make before break⊕	Metal	5	⊕
KCB1L11	KNB1L11	1NO+1NC	Plastic	5	⊕
KCB2L11	KNB2L11	Slow action⊕	Metal	5	⊕
KCB1L02	KNB L02	2NC	Plastic	5	⊕
KCB2L02	KNB2L02	Slow action⊕	Metal	5	⊕
KCB1L20	KNB1L20	2NO	Plastic	5	⊕
KCB2L20	KNB2L20	Slow action	Metal	5	⊕

⊕ Direct (positive) opening action ⊖; safety function according to IEC/EN/BS 60947-5-1.

⊕ Consult Technical support for information; see contact details on inside cover.

Ø11x4mm = Ø0.43x0.16".

General characteristics

The LOVATO Electric limit switches have been designed to satisfy requirements comprising quick installation, easy wiring, simple setup, modularity, sturdiness and constant reliability.

The body cover is hinged at the bottom and removable. The innovative locking bayonet mechanism permits to remove and reposition the operating head in the required configuration with no tools. The heads have axial rotation of 45° angles.

The auxiliary contact blocks are removable assuring remarkable wiring ease.

Operational characteristics

- Maximum operating rate: 3600 cycles/h
- Switching speed: 0.5...1.5m/s
- Mechanical life: >10 million cycles
- IEC conventional thermal current Ith: 10A
- UL/CSA and IEC/EN/BS 60947-5-1 designation:
 - A600 Q300 for KB...-KC... types
 - A300 Q300 for KM...-KN... types
- IEC rated insulation voltage Ui:
 - 690VAC for KB...-KC... types
 - 440VAC for KM...-KN... types
- IEC rated impulse withstand voltage Uimp:
 - 6kV for KB...-KC... types
 - 4kV for KM...-KN... types
- Class II insulation for KB...-KC... only
- Contact resistance: <10mΩ
- Short-circuit backup protection: 10A gG/SC quick fuse
- Operators of aluminium-zinc alloy
- Housing:
 - KB...-KC... types: self-extinguishing double-insulation polymer thermoplastic
 - KM...-KN... types: aluminium-zinc alloy
- Cable entry: M20 standard supplied; PG13.5 and 1/2 NPT available (see the side note for details)
- Operating head fixing: locking bayonet insert
- Operating force: 5N / 1.1lb
- Cable connection: self-releasing screw terminal
- Tightening torque:
 - Switch fixing: 2.5Nm / 22.1lb.in
 - Contact terminals: 0.8Nm / 7lb.in
 - Body lid screw fixing: 0.8Nm / 7lb.in
- Conductor section: 1 or 2 2.5mm² max / 16-14AWG
- Ambient conditions:
 - Operating temperature: -25...+70°C
 - Storage temperature: -40...+70°C
 - Pollution degree: 3
 - IEC degree of protection: IP20 for terminals
 - IEC degree of protection: IP65 for body housing.

Certifications and compliance

Certifications obtained: UL Listed for USA and Canada (cULus - File E93601), as Auxiliary Devices - Limit switches; EAC, CCC.

Compliant with standards: EN/BS 50047, IEC/EN/BS 60947-1, IEC/EN/BS 60947-5-1, IEC/EN/BS 60204-1, UL508, CSA C22.2 n° 14.

- ▶ Forward travel of snap action contacts
- ◀ Return travel of snap action contacts
- open
- closed

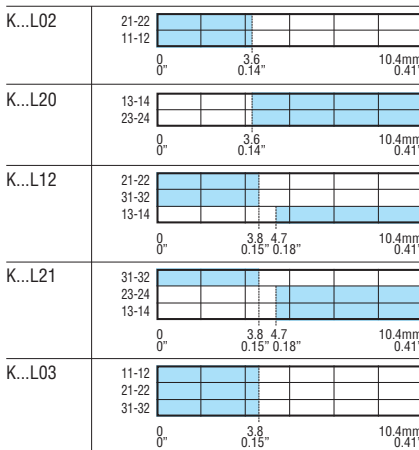
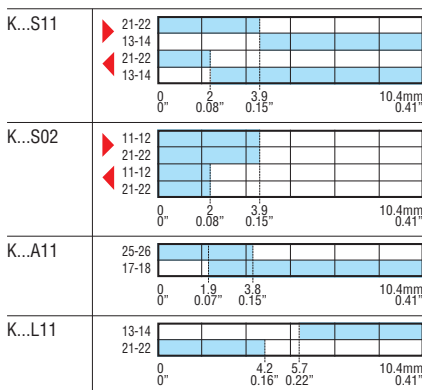

9 Limit, micro and foot switches

Limit switches, K series. One bottom cable entry. Dimensions to EN/BS 50047
Two side cable entries. Dimensions compatible to EN/BS 50047

Roller centre push lever



KBC... - KMC...

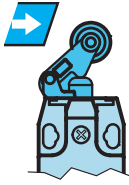

KCC... - KNC...

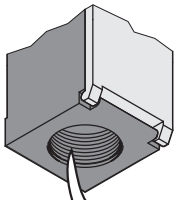

M20 CABLE ENTRY

For types with PG13.5 cable entry, add the letter P at the end of the order code while for 1/2 NPT, add N. E.g. KBC1S11P - KBC1S11N

Order code Plastic body	Metal body	Contacts	Roller material	Qty per pkg n°	Wt [kg]
-------------------------	------------	----------	-----------------	----------------	---------

One bottom cable entry. Dimensions to EN/BS 50047.

KBC1S11	KMC1S11	1NO+1NC	Plastic	5	⊕
KBC2S11	KMC2S11	Snap actionⓈ	Metal	5	⊕
KBC1S02	KMC1S02	2NC	Plastic	5	⊕
KBC2S02	KMC2S02	Snap actionⓈ	Metal	5	⊕
KBC1A11	KMC1A11	1NO+1NC	Plastic	5	⊕
KBC2A11	KMC2A11	Slow action make before breakⓈ	Metal	5	⊕
KBC1L11	KMC1L11	1NO+1NC	Plastic	5	⊕
KBC2L11	KMC2L11	Slow actionⓈ	Metal	5	⊕
KBC1L02	KMC1L02	2NC	Plastic	5	⊕
KBC2L02	KMC2L02	Slow actionⓈ	Metal	5	⊕
KBC1L20	KMC1L20	2NO	Plastic	5	⊕
KBC2L20	KMC2L20	Slow action	Metal	5	⊕
KBC1L12	KMC1L12	1NO+2NC	Plastic	5	⊕
KBC2L12	KMC2L12	Slow actionⓈ	Metal	5	⊕
KBC1L21	KMC1L21	2NO+1NC	Plastic	5	⊕
KBC2L21	KMC2L21	Slow actionⓈ	Metal	5	⊕
KBC1L03	KMC1L03	3NC	Plastic	5	⊕
KBC2L03	KMC2L03	Slow actionⓈ	Metal	5	⊕

Two side cable entries. Dimensions compatible to EN/BS 50047.

KCC1S11	KNC1S11	1NO+1NC	Plastic	5	⊕
KCC2S11	KNC2S11	Snap actionⓈ	Metal	5	⊕
KCC1S02	KNC1S02	2NC	Plastic	5	⊕
KCC2S02	KNC2S02	Snap actionⓈ	Metal	5	⊕
KCC1A11	KNC1A11	1NO+1NC	Plastic	5	⊕
KCC2A11	KNC2A11	Slow action make before breakⓈ	Metal	5	⊕
KCC1L11	KNC1L11	1NO+1NC	Plastic	5	⊕
KCC2L11	KNC2L11	Slow actionⓈ	Metal	5	⊕
KCC1L02	KNC1L02	2NC	Plastic	5	⊕
KCC2L02	KNC2L02	Slow actionⓈ	Metal	5	⊕
KCC1L20	KNC1L20	2NO	Plastic	5	⊕
KCC2L20	KNC2L20	Slow action	Metal	5	⊕

Ⓢ Direct (positive) opening action ⊕ safety function according to IEC/EN/BS 60947-5-1.

⊕ Consult Technical support for information; see contact details on inside cover.

Ø14x5mm = Ø0.55x0.2".

General characteristics

The LOVATO Electric limit switches have been designed to satisfy requirements comprising quick installation, easy wiring, simple setup, modularity, sturdiness and constant reliability.

The body cover is hinged at the bottom and removable.

The innovative locking bayonet mechanism permits to remove and reposition the operating head in the required configuration with no tools. The heads have axial rotation of 45° angles.

The auxiliary contact blocks are removable assuring remarkable wiring ease.

Operational characteristics

- Maximum operating rate: 3600 cycles/h
- Switching speed: 0.5...1.5m/s
- Mechanical life: >10 million cycles
- IEC conventional thermal current Ith: 10A
- UL/CSA and IEC/EN/BS 60947-5-1 designation:
 - A600 Q300 for KB...-KC... types
 - A300 Q300 for KM...-KN... types
- IEC rated insulation voltage Ui:
 - 690VAC for KB...-KC... types
 - 440VAC for KM...-KN... types
- IEC rated impulse withstand voltage Uimp:
 - 6kV for KB...-KC... types
 - 4kV for KM...-KN... types
- Class II insulation for KB...-KC... only
- Contact resistance: <10mΩ
- Short-circuit backup protection: 10A gG/SC quick fuse
- Operators of aluminium-zinc alloy
- Housing:
 - KB...-KC... types: self-extinguishing double-insulation polymer thermoplastic
 - KM...-KN... types: aluminium-zinc alloy
- Cable entry: M20 standard supplied; PG13.5 and 1/2 NPT available (see the side note for details)
- Operating head fixing: locking bayonet insert
- Operating force: 6N / 1.34lb
- Cable connection: self-releasing screw terminal
- Tightening torque:
 - Switch fixing: 2.5Nm / 22.1lb.in
 - Contact terminals: 0.8Nm / 7lb.in
 - Body lid screw fixing: 0.8Nm / 7lb.in
- Conductor section: 1 or 2 2.5mm² max / 16-14AWG
- Ambient conditions:
 - Operating temperature: -25...+70°C
 - Storage temperature: -40...+70°C
 - Pollution degree: 3
 - IEC degree of protection: IP20 for terminals
 - IEC degree of protection: IP65 for body housing.

Certifications and compliance

Certifications obtained: UL Listed for USA and Canada (cULus - File E93601), as Auxiliary Devices - Limit switches; EAC, CCC.

Compliant with standards: EN/BS 50047, IEC/EN/BS 60947-1, IEC/EN/BS 60947-5-1, IEC/EN/BS 60204-1, UL508, CSA C22.2 n° 14.

- ▶ Forward travel of snap action contacts
- ◀ Return travel of snap action contacts

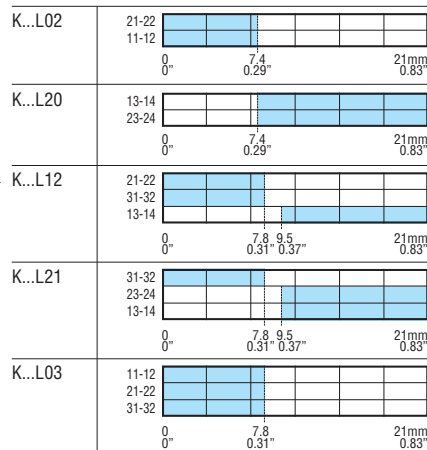
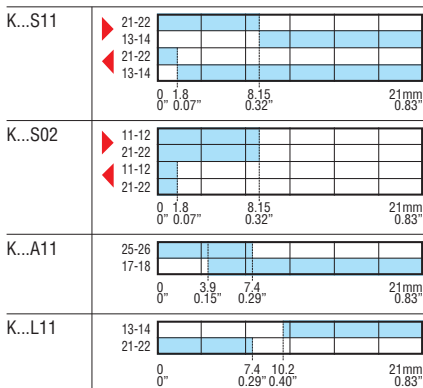

9 Limit, micro and foot switches

Limit switches, K series. One bottom cable entry. Dimensions to EN/BS 50047
Two side cable entries. Dimensions compatible to EN/BS 50047

Roller side push lever

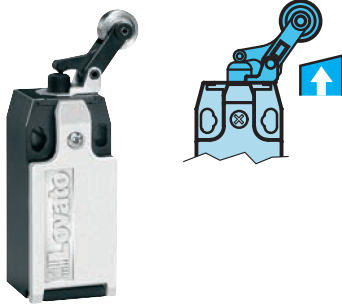

KBD... - KMD...



KCD... - KND...

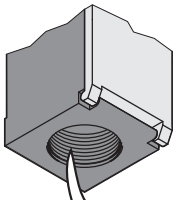

M20 CABLE ENTRY

For types with PG13.5 cable entry, add the letter P at the end of the order code while for 1/2 NPT, add N. E.g. KBD1S11P - KBD1S11N

Order code Plastic body	Order code Metal body	Contacts	Roller material	Qty per pkg	Wt [kg]
			Ø14x5	n°	[kg]

One bottom cable entry. Dimensions to EN/BS 50047.

KBD1S11	KMD1S11	1NO+1NC	Plastic	5	⊕
KBD2S11	KMD2S11	Snap action ⊕	Metal	5	⊕
KBD1S02	KMD1S02	2NC	Plastic	5	⊕
KBD2S02	KMD2S02	Snap action ⊕	Metal	5	⊕
KBD1A11	KMD1A11	1NO+1NC	Plastic	5	⊕
KBD2A11	KMD2A11	Slow action make before break ⊕	Metal	5	⊕
KBD1L11	KMD1L11	1NO+1NC	Plastic	5	⊕
KBD2L11	KMD2L11	Slow action ⊕	Metal	5	⊕
KBD1L02	KMD1L02	2NC	Plastic	5	⊕
KBD2L02	KMD2L02	Slow action ⊕	Metal	5	⊕
KBD1L20	KMD1L20	2NO	Plastic	5	⊕
KBD2L20	KMD2L20	Slow action	Metal	5	⊕
KBD1L12	KMD1L12	1NO+2NC	Plastic	5	⊕
KBD2L12	KMD2L12	Slow action ⊕	Metal	5	⊕
KBD1L21	KMD1L21	2NO+1NC	Plastic	5	⊕
KBD2L21	KMD2L21	Slow action ⊕	Metal	5	⊕
KBD1L03	KMD1L03	3NC	Plastic	5	⊕
KBD2L03	KMD2L03	Slow action ⊕	Metal	5	⊕

Two side cable entries. Dimensions compatible to EN/BS 50047.

KCD1S11	KND1S11	1NO+1NC	Plastic	5	⊕
KCD2S11	KND2S11	Snap action ⊕	Metal	5	⊕
KCD1S02	KND1S02	2NC	Plastic	5	⊕
KCD2S02	KND2S02	Snap action ⊕	Metal	5	⊕
KCD1A11	KND1A11	1NO+1NC	Plastic	5	⊕
KCD2A11	KND2A11	Slow action make before break ⊕	Metal	5	⊕
KCD1L11	KND1L11	1NO+1NC	Plastic	5	⊕
KCD2L11	KND2L11	Slow action ⊕	Metal	5	⊕
KCD1L02	KND1L02	2NC	Plastic	5	⊕
KCD2L02	KND2L02	Slow action ⊕	Metal	5	⊕
KCD1L20	KND1L20	2NO	Plastic	5	⊕
KCD2L20	KND2L20	Slow action	Metal	5	⊕

⊕ Direct (positive) opening action ⊖ safety function according to IEC/EN/BS 60947-5-1.

⊕ Consult Technical support for information; see contact details on inside cover.

Ø14x5mm = Ø0.55x0.2".

General characteristics

The LOVATO Electric limit switches have been designed to satisfy requirements comprising quick installation, easy wiring, simple setup, modularity, sturdiness and constant reliability.

The body cover is hinged at the bottom and removable.

The innovative locking bayonet mechanism permits to remove and reposition the operating head in the required configuration with no tools. The heads have axial rotation of 45° angles.

The auxiliary contact blocks are removable assuring remarkable wiring ease.

Operational characteristics

- Maximum operating rate: 3600 cycles/h
- Switching speed: 0.5...1.5m/s
- Mechanical life: >10 million cycles
- IEC conventional thermal current Ith: 10A
- UL/CSA and IEC/EN/BS 60947-5-1 designation:
 - A600 Q300 for KB...-KC... types
 - A300 Q300 for KM...-KN... types
- IEC rated insulation voltage Ui:
 - 690VAC for KB...-KC... types
 - 440VAC for KM...-KN... types
- IEC rated impulse withstand voltage Uimp:
 - 6kV for KB...-KC... types
 - 4kV for KM...-KN... types
- Class II insulation for KB...-KC... only
- Contact resistance: <10mΩ
- Short-circuit backup protection: 10A gG/SC quick fuse
- Operators of aluminium-zinc alloy
- Housing:
 - KB...-KC... types: self-extinguishing double-insulation polymer thermoplastic
 - KM...-KN... types: aluminium-zinc alloy
- Cable entry: M20 standard supplied; PG13.5 and 1/2 NPT available (see the side note for details)
- Operating head fixing: locking bayonet insert
- Operating force: 6N / 1.34lb
- Cable connection: self-releasing screw terminal
- Tightening torque:
 - Switch fixing: 2.5Nm / 22.1lb.in
 - Contact terminals: 0.8Nm / 7lb.in
 - Body lid screw fixing: 0.8Nm / 7lb.in
- Conductor section: 1 or 2 2.5mm² max / 16-14AWG
- Ambient conditions:
 - Operating temperature: -25...+70°C
 - Storage temperature: -40...+70°C
 - Pollution degree: 3
 - IEC degree of protection: IP20 for terminals
 - IEC degree of protection: IP65 for body housing.

Certifications and compliance

Certifications obtained: UL Listed for USA and Canada (cULus - File E93601), as Auxiliary Devices - Limit switches; EAC, CCC.

Compliant with standards: EN/BS 50047, IEC/EN/BS 60947-1, IEC/EN/BS 60947-5-1, IEC/EN/BS 60204-1, UL508, CSA C22.2 n° 14.

- ▶ Forward travel of snap action contacts
- ◀ Return travel of snap action contacts
- open
- closed

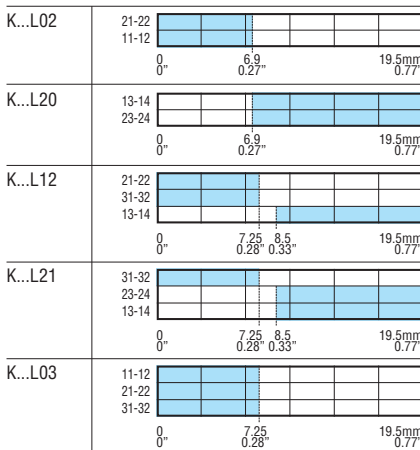
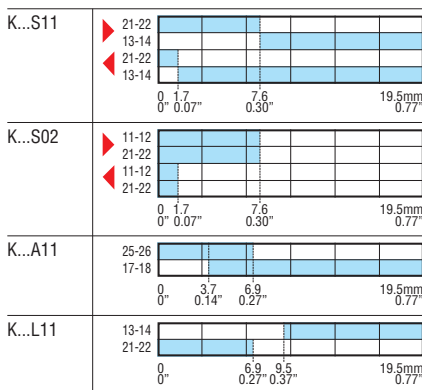

9 Limit, micro and foot switches

Limit switches, K series.

One bottom cable entry. Dimensions to EN/BS 50047



INDEX

Roller lever plunger



KBE1... - KBE2...
KME1... - KME2...

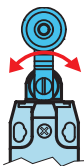

KBE3... - KME3...

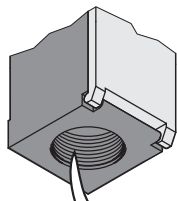

M20 CABLE ENTRY

For types with PG13.5 cable entry, add the letter P at the end of the order code while for 1/2 NPT, add N. E.g. KBE1S11P - KBE1S11N

Order code Plastic body	Order code Metal body	Contacts	Roller material	Qty per pkg	Wt [kg]
One bottom cable entry. Dimensions to EN/BS 50047.					
KBE1S11	KME1S11	1NO+1NC	Plastic ①	5	④
KBE2S11	KME2S11	Snap action ③	Metal ①	5	④
KBE3S11	KME3S11		Rubber ②	5	④
KBE1S02	KME1S02	2NC	Plastic ①	5	④
KBE2S02	KME2S02	Snap action ③	Metal ①	5	④
KBE3S02	KME3S02		Rubber	5	④
KBE1A11	KME1A11	1NO+1NC	Plastic ①	5	④
KBE2A11	KME2A11	Slow action make before break ⑥	Metal ①	5	④
KBE3A11	KME3A11		Rubber ②	5	④
KBE1L11	KME1L11	1NO+1NC	Plastic ①	5	④
KBE2L11	KME2L11	Slow action ③	Metal ①	5	④
KBE3L11	KME3L11		Rubber ②	5	④
KBE1L02	KME1L02	2NC	Plastic ①	5	④
KBE2L02	KME2L02	Slow action ③	Metal ①	5	④
KBE3L02	KME3L02		Rubber ②	5	④
KBE1L20	KME1L20	2NO	Plastic ①	5	④
KBE2L20	KME2L20	Slow action	Metal ①	5	④
KBE3L20	KME3L20		Rubber ②	5	④
KBE1L12	KME1L12	1NO+2NC	Plastic ①	5	④
KBE2L12	KME2L12	Slow action ③	Metal ①	5	④
KBE3L12	KME3L12		Rubber ②	5	④
KBE1L21	KME1L21	2NO+1NC	Plastic ①	5	④
KBE2L21	KME2L21	Slow action ③	Metal ①	5	④
KBE3L21	KME3L21		Rubber ②	5	④
KBE1L03	KME1L03	3NC	Plastic ①	5	④
KBE2L03	KME2L03	Slow action ③	Metal ①	5	④
KBE3L03	KME3L03		Rubber ②	5	④

BI-DIRECTIONAL.

One bottom cable entry. Dimensions to EN/BS 50047.

Order code Plastic body	Order code Metal body	Contacts	Roller material	Qty per pkg	Wt [kg]
KBE1D02	KME1D02	2NC ③ independent	Plastic ①	5	⑤

① Ø19x5mm = Ø0.75x0.2"

② Ø50x10mm = Ø1.97"x0.39"

③ Direct (positive) opening action ⊖; safety function according to IEC/EN/BS 60947-5-1.

④ Consult Technical support for information; see contact details on inside cover.

General characteristics

The LOVATO Electric limit switches have been designed to satisfy requirements comprising quick installation, easy wiring, simple setup, modularity, sturdiness and constant reliability.

The body cover is hinged at the bottom and removable.

The innovative locking bayonet mechanism permits to remove and reposition the operating head in the required configuration with no tools. The heads have axial rotation of 45° angles.

The auxiliary contact blocks are removable assuring remarkable wiring ease.

Operational characteristics

- Maximum operating rate: 3600 cycles/h
- Switching speed: 0.5...1.5m/s
- Mechanical life: >10 million cycles
- IEC conventional thermal current Ith: 10A
- UL/CSA and IEC/EN/BS 60947-5-1 designation:
 - A600 Q300 for KB... types
 - A300 Q300 for KM... types
- IEC rated insulation voltage Ui:
 - 690V for KB... types
 - 440V for KM... types
- IEC rated impulse withstand voltage Uimp:
 - 6kVAC for KB... types
 - 4kVAC for KM... types
- Class II insulation for KB only
- Contact resistance: <10mΩ
- Short-circuit backup protection: 10A gG/SC quick fuse
- Operators of aluminium-zinc alloy
- Housing:
 - KB... types: self-extinguishing double-insulation polymer thermoplastic
 - KM... types: aluminium-zinc alloy
- Cable entry: M20 standard supplied; PG13.5 and 1/2 NPT available (see the side note for details)
- Operating head fixing: locking bayonet insert
- Operating torque: 3Ncm / 4.25ozin
- Cable connection: self-releasing screw terminal
- Tightening torque:
 - Switch fixing: 2.5Nm / 22.1lb.in
 - Contact terminals: 0.8Nm / 7lb.in
 - Body lid screw fixing: 0.8Nm / 7lb.in
- Conductor section: 1 or 2 2.5mm² max / 16-14AWG
- Ambient conditions:
 - Operating temperature: -25...+70°C
 - Storage temperature: -40...+70°C
 - Pollution degree: 3
 - IEC degree of protection: IP20 for terminals
 - IEC degree of protection: IP65 for body housing.

Certifications and compliance

Certifications obtained: UL Listed for USA and Canada (cULus - File E93601), as Auxiliary Devices - Limit switches; EAC, CCC.

Compliant with standards: EN/BS 50047, IEC/EN/BS 60947-1, IEC/EN/BS 60947-5-1, IEC/EN/BS 60204-1, UL508, CSA C22.2 n° 14.

- ▶ Forward travel of snap action contacts
- ◀ Return travel of snap action contacts

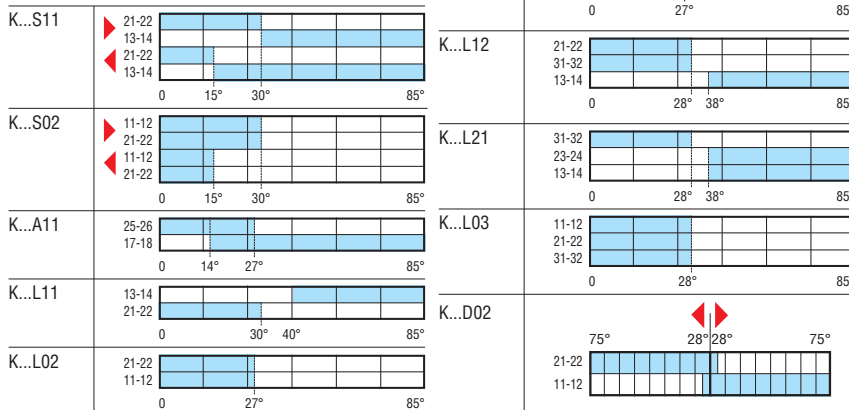

9 Limit, micro and foot switches

Limit switches, K series.
Two side cable entries. Dimensions compatible to EN/BS 50047

Roller lever plunger



KCE1... - KCE2...
KNE1... - KNE2...

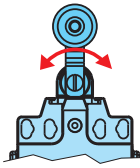

KCE3... - KNE3...

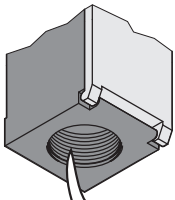

M20 CABLE ENTRY

For types with PG13.5 cable entry, add the letter P at the end of the order code while for 1/2 NPT, add N. E.g. KCE1S11P - KCE1S11N

Order code Plastic body	Order code Metal body	Contacts	Roller material	Qty per pkg	Wt [kg]
-------------------------	-----------------------	----------	-----------------	-------------	---------

Two side cable entries. Dimensions compatible to EN/BS 50047.

KCE1S11	KNE1S11	1NO+1NC	Plastic ①	5	④
KCE2S11	KNE2S11	Snap action ⑤	Metal ①	5	④
KCE3S11	KNE3S11		Rubber ②	5	④
KCE1S02	KNE1S02	2NC	Plastic ①	5	④
KCE2S02	KNE2S02	Snap action ⑤	Metal ①	5	④
KCE3S02	KNE3S02		Rubber	5	④
KCE1A11	KNE1A11	1NO+1NC	Plastic ①	5	④
KCE2A11	KNE2A11	Slow action make before break ⑥	Metal ①	5	④
KCE3A11	KNE3A11		Rubber ②	5	④
KCE1L11	KNE1L11	1NO+1NC	Plastic ①	5	④
KCE2L11	KNE2L11	Slow action ⑥	Metal ①	5	④
KCE3L11	KNE3L11		Rubber ②	5	④
KCE1L02	KNE1L02	2NC	Plastic ①	5	④
KCE2L02	KNE2L02	Slow action ⑥	Metal ①	5	④
KCE3L02	KNE3L02		Rubber ②	5	④
KCE1L20	KNE1L20	2NO	Plastic ①	5	④
KCE2L20	KNE2L20	Slow action	Metal ①	5	④
KCE3L20	KNE3L20		Rubber ②	5	④

BI-DIRECTIONAL.
Two side cable entries. Dimensions compatible to EN/BS 50047.

KCE1D02	KNE1D02	2NC ③ independent	Plastic ①	5	④
---------	---------	-------------------	-----------	---	---

- ① Ø19x5mm = Ø0.75"x0.2".
- ② Ø50x10mm = Ø1.97"x0.39".
- ③ Direct (positive) opening action ⊕; safety function according to IEC/EN/BS 60947-5-1.
- ④ Consult Technical support for information; see contact details on inside cover.

General characteristics

The LOVATO Electric limit switches have been designed to satisfy requirements comprising quick installation, easy wiring, simple setup, modularity, sturdiness and constant reliability.

The body cover is hinged at the bottom and removable. The innovative locking bayonet mechanism permits to remove and reposition the operating head in the required configuration with no tools. The heads have axial rotation of 90° angles.

The auxiliary contact blocks are removable assuring remarkable wiring ease.

Operational characteristics

- Maximum operating rate: 3600 cycles/h
- Switching speed: 0.5...1.5m/s
- Mechanical life: >10 million cycles
- IEC conventional thermal current Ith: 10A
- UL/CSA and IEC/EN/BS 60947-5-1 designation:
 - A600 Q300 for KC... types
 - A300 Q300 for KN... types
- IEC rated insulation voltage Ui:
 - 690VAC for KC... types
 - 440VAC for KN... types
- IEC rated impulse withstand voltage Uimp:
 - 6kV for KC... types
 - 4kV for KN... types
- Class II insulation for KC only
- Contact resistance: <10mΩ
- Short-circuit backup protection: 10A gG/SC quick fuse
- Operators of aluminium-zinc alloy
- Housing:
 - KC... types: self-extinguishing double-insulation polymer thermoplastic
 - KN... types: aluminium-zinc alloy
- Cable entry: M20 standard supplied; PG13.5 and 1/2 NPT available (see the side note for details)
- Operating head fixing: locking bayonet insert
- Operating torque: 3Ncm/4.25ozin
- Cable connection: self-releasing screw terminal
- Tightening torque:
 - Switch fixing: 2.5Nm / 22.1lb.in
 - Contact terminals: 0.8Nm / 7lb.in
 - Body lid screw fixing: 0.8Nm / 7lb.in
- Conductor section: 1 or 2 2.5mm² max / 16-14AWG
- Ambient conditions:
 - Operating temperature: -25...+70°C
 - Storage temperature: -40...+70°C
 - Pollution degree: 3
 - IEC degree of protection: IP20 for terminals
 - IEC degree of protection: IP65 for body housing.

Certifications and compliance

Certifications obtained: UL Listed for USA and Canada (cULus - File E93601), as Auxiliary Devices - Limit switches; EAC, CCC.

Compliant with standards: IEC/EN/BS 60947-1, IEC/EN/BS 60947-5-1, IEC/EN/BS 60204-1, UL508, CSA C22.2 n° 14.

- ▶ Forward travel of snap action contacts open
- ◀ Return travel of snap action contacts closed

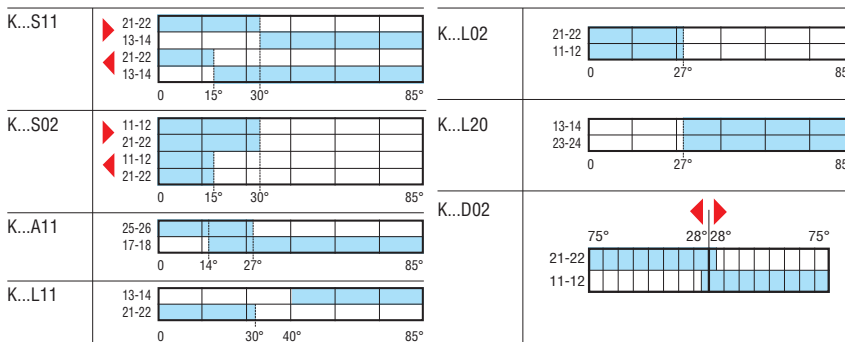

9 Limit, micro and foot switches

Limit switches, K series.
One bottom cable entry. Dimensions to EN/BS 50047

Adjustable roller lever



KB... - KMF...

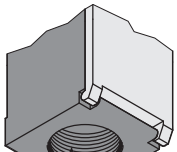
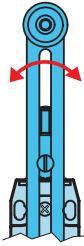

M20 CABLE ENTRY

For types with PG13.5 cable entry, add the letter P at the end of the order code while for 1/2 NPT, add N. E.g. KBF1S11P - KBF1S11N

Order code Plastic body	Order code Metal body	Contacts	Roller material	Qty per pkg	Wt [kg]
One bottom cable entry. Dimensions to EN/BS 50047.					
KBF1S11	KMF1S11	1NO+1NC	Plastic ①	5	⑤
KBF2S11	KMF2S11	Snap action ④	Metal ①	5	⑤
KBF3S11	KMF3S11		Rubber ②	5	⑤
KBF4S11	KMF4S11		Rubber ③	5	⑤
KBF1S02	KMF1S02		2NC	Plastic ①	5
KBF2S02	KMF2S02	Snap action ④	Metal ①	5	⑤
KBF3S02	KMF3S02		Rubber ②	5	⑤
KBF4S02	KMF4S02		Rubber ③	5	⑤
KBF1A11	KMF1A11	1NO+1NC	Plastic ①	5	⑤
KBF2A11	KMF2A11	Slow action make before break ④	Metal ①	5	⑤
KBF3A11	KMF3A11		Rubber ②	5	⑤
KBF4A11	KMF4A11		Rubber ③	5	⑤
KBF1L11	KMF1L11		1NO+1NC	Plastic ①	5
KBF2L11	KMF2L11	Slow action ④	Metal ①	5	⑤
KBF3L11	KMF3L11		Rubber ②	5	⑤
KBF4L11	KMF4L11		Rubber ③	5	⑤
KBF1L02	KMF1L02	2NC	Plastic ①	5	⑤
KBF2L02	KMF2L02	Slow action ④	Metal ①	5	⑤
KBF3L02	KMF3L02		Rubber ②	5	⑤
KBF4L02	KMF4L02		Rubber ③	5	⑤
KBF1L20	KMF1L20	2NO	Plastic ①	5	⑤
KBF2L20	KMF2L20	Slow action	Metal ①	5	⑤
KBF3L20	KMF3L20		Rubber ②	5	⑤
KBF4L20	KMF4L20		Rubber ③	5	⑤
KBF1L12	KMF1L12	1NO+2NC	Plastic ①	5	⑤
KBF2L12	KMF2L12	Slow action ④	Metal ①	5	⑤
KBF3L12	KMF3L12		Rubber ②	5	⑤
KBF4L12	KMF4L12		Rubber ③	5	⑤
KBF1L21	KMF1L21		2NO+1NC	Plastic ①	5
KBF2L21	KMF2L21	Slow action ④	Metal ①	5	⑤
KBF3L21	KMF3L21		Rubber ②	5	⑤
KBF4L21	KMF4L21		Rubber ③	5	⑤
KBF1L03	KMF1L03	3NC	Plastic ①	5	⑤
KBF2L03	KMF2L03	Slow action ④	Metal ①	5	⑤
KBF3L03	KMF3L03		Rubber ②	5	⑤
KBF4L03	KMF4L03		Rubber ③	5	⑤

BI-DIRECTIONAL.
One bottom cable entry. Dimensions to EN/BS 50047.

KBF1D02	KMF1D02	2NC ④ independent	Plastic ①	5	⑤
---------	---------	-------------------	-----------	---	---

- ① Ø19x5mm = Ø0.75x0.2".
- ② Ø50x10mm = Ø1.97x0.34".
- ③ Ø50x10mm (Ø1.97x0.35") with offset alignment.
- ④ Direct (positive) opening action ↺; safety function according to IEC/EN/BS 60947-5-1.
- ⑤ Consult Technical support for information; see contact details on inside cover.

General characteristics

The LOVATO Electric limit switches have been designed to satisfy requirements comprising quick installation, easy wiring, simple setup, modularity, sturdiness and constant reliability.

The body cover is hinged at the bottom and removable. The innovative locking bayonet mechanism permits to remove and reposition the operating head in the required configuration with no tools. The heads have axial rotation of 180° angles.

The auxiliary contact blocks are removable assuring remarkable wiring ease.

Operational characteristics

- Maximum operating rate: 3600 cycles/h
- Switching speed: 0.5...1.5m/s
- Mechanical life: >10 million cycles
- IEC conventional thermal current Ith: 10A
- UL/CSA and IEC/EN/BS 60947-5-1 designation:
 - A600 Q300 for KB... types
 - A300 Q300 for KM... types
- IEC rated insulation voltage Ui:
 - 690V for KB... types
 - 440V for KM... types
- IEC rated impulse withstand voltage Uimp:
 - 6kVAC for KB... types
 - 4kVAC for KM... types
- Class II insulation for KB only
- Contact resistance: <10mΩ
- Short-circuit backup protection: 10A gG/SC quick fuse
- Operators of aluminium-zinc alloy
- Housing:
 - KB... types: self-extinguishing double-insulation polymer thermoplastic
 - KM... types: aluminium-zinc alloy
- Cable entry: M20 standard supplied; PG13.5 and 1/2 NPT available (see the side note for details)
- Operating head fixing: locking bayonet insert
- Operating force: 3Ncm / 4.25ozin
- Cable connection: self-releasing screw terminal
- Tightening torque:
 - Switch fixing: 2.5Nm / 22.1lb.in
 - Contact terminals: 0.8Nm / 7lb.in
 - Body lid screw fixing: 0.8Nm / 7lb.in
- Conductor section: 1 or 2 2.5mm² max / 16-14AWG
- Ambient conditions:
 - Operating temperature: -25...+70°C
 - Storage temperature: -40...+70°C
 - Pollution degree: 3
 - IEC degree of protection: IP20 for terminals
 - IEC degree of protection: IP65 for body housing.

Certifications and compliance

Certifications obtained: UL Listed for USA and Canada (cULus - File E93601), as Auxiliary Devices - Limit switches; EAC, CCC.
Compliant with standards: EN/BS 50047, IEC/EN/BS 60947-1, IEC/EN/BS 60947-5-1, IEC/EN/BS 60204-1, UL508, CSA C22.2 n° 14.

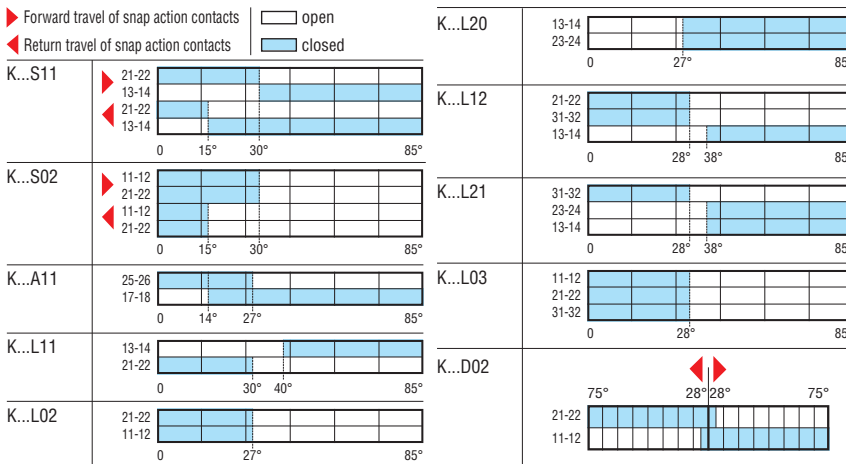

9 Limit, micro and foot switches

Limit switches, K series.
Two side cable entries. Dimensions compatible to EN/BS 50047

Adjustable roller lever

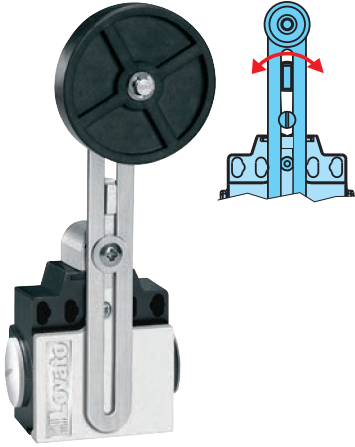

KCF... - KNF...

Order code Plastic body	Metal body	Contacts	Roller material	Qty per pkg	Wt n° [kg]
Two side cable entries. Dimensions compatible to EN/BS 50047.					
KCF1S11	KNF1S11	1NO+1NC Snap action [⊕]	Plastic ^①	5	④
KCF2S11	KNF2S11		Metal ^①	5	④
KCF3S11	KNF3S11		Rubber ^②	5	④
KCF4S11	KNF4S11		Rubber ^② offset align.	5	④
KCF1S02	KNF1S02	2NC Snap action [⊕]	Plastic ^①	5	④
KCF2S02	KNF2S02		Metal ^①	5	④
KCF3S02	KNF3S02		Rubber ^②	5	④
KCF4S02	KNF4S02		Rubber ^② offset align.	5	④
KCF1A11	KNF1A11	1NO+1NC Slow action make before break [⊕]	Plastic ^①	5	④
KCF2A11	KNF2A11		Metal ^①	5	④
KCF3A11	KNF3A11		Rubber ^②	5	④
KCF4A11	KNF4A11		Rubber ^② offset align.	5	④
KCF1L11	KNF1L11	1NO+1NC Slow action [⊕]	Plastic ^①	5	④
KCF2L11	KNF2L11		Metal ^①	5	④
KCF3L11	KNF3L11		Rubber ^②	5	④
KCF4L11	KNF4L11		Rubber ^② offset align.	5	④
KCF1L02	KNF1L02	2NC Slow action [⊕]	Plastic ^①	5	④
KCF2L02	KNF2L02		Metal ^①	5	④
KCF3L02	KNF3L02		Rubber ^②	5	④
KCF4L02	KNF4L02		Rubber ^② offset align.	5	④
KCF1L20	KNF1L20	2NO Slow action	Plastic ^①	5	④
KCF2L20	KNF2L20		Metal ^①	5	④
KCF3L20	KNF3L20		Rubber ^②	5	④
KCF4L20	KNF4L20		Rubber ^② offset align.	5	④

① Ø19x5mm = Ø0.75x0.2".
 ② Ø50x10mm = Ø1.97x0.34".
 ⊕ Direct (positive) opening action ⊖ safety function according to IEC/EN/BS 60947-5-1.
 ④ Consult Technical support for information; see contact details on inside cover.

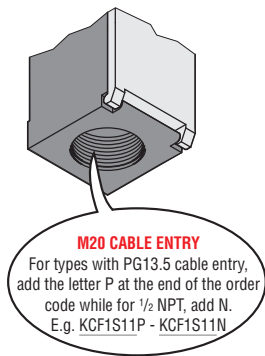

General characteristics

The LOVATO Electric limit switches have been designed to satisfy requirements comprising quick installation, easy wiring, simple setup, modularity, sturdiness and constant reliability.

The body cover is hinged at the bottom and removable. The innovative locking bayonet mechanism permits to remove and reposition the operating head in the required configuration with no tools. The heads have axial rotation of 180° angles.

The auxiliary contact blocks are removable assuring remarkable wiring ease.

Operational characteristics

- Maximum operating rate: 3600 cycles/h
- Switching speed: 0.5...1.5m/s
- Mechanical life: >10 million cycles
- IEC conventional thermal current Ith: 10A
- UL/CSA and IEC/EN/BS 60947-5-1 designation:
 - A600 Q300 for KC... types
 - A300 Q300 for KN... types
- IEC rated insulation voltage Ui:
 - 690VAC for KC... types
 - 440VAC for KN... types
- IEC rated impulse withstand voltage Uimp:
 - 6kV for KC... types
 - 4kV for KN... types
- Class II insulation for KC only
- Contact resistance: <10mΩ
- Short-circuit backup protection: 10A gG/SC quick fuse
- Operators of aluminium-zinc alloy
- Housing:
 - KC... types: self-extinguishing double-insulation polymer thermoplastic
 - KN... types: aluminium-zinc alloy
- Cable entry: M20 standard supplied; PG13.5 and 1/2 NPT available (see the side note for details)
- Operating head fixing: locking bayonet insert
- Operating force: 3Ncm/4.25ozin
- Cable connection: self-releasing screw terminal
- Tightening torque:
 - Switch fixing: 2.5Nm / 22.1lb.in
 - Contact terminals: 0.8Nm / 7lb.in
 - Body lid screw fixing: 0.8Nm / 7lb.in
- Conductor section: 1 or 2 2.5mm² max / 16-14AWG
- Ambient conditions:
 - Operating temperature: -25...+70°C
 - Storage temperature: -40...+70°C
 - Pollution degree: 3
 - IEC degree of protection: IP20 for terminals
 - IEC degree of protection: IP65 for body housing.

Certifications and compliance

Certifications obtained: UL Listed for USA and Canada (cULus - File E93601), as Auxiliary Devices - Limit switches; EAC, CCC.
 Compliant with standards: EN/BS 50047, IEC/EN/BS 60947-1, IEC/EN/BS 60947-5-1, IEC/EN/BS 60204-1, UL508, CSA C22.2 n° 14.

▶ Forward travel of snap action contacts □ open
 ◀ Return travel of snap action contacts ■ closed

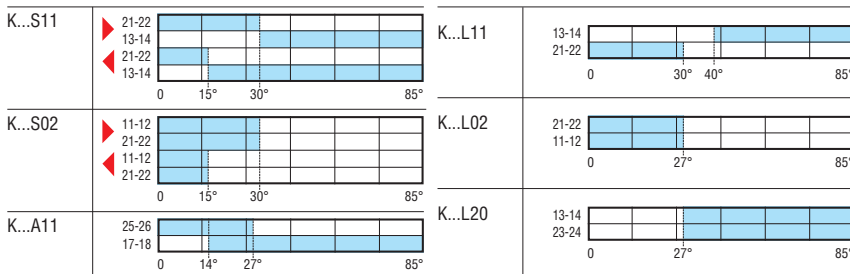

9 Limit, micro and foot switches

Limit switches, K series. One bottom cable entry. Dimensions to EN/BS 50047
Two side cable entries. Dimensions compatible to EN/BS 50047

Ceramic rod lever



KBH... - KMH...

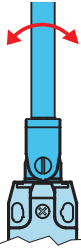

KCH... - KNH...

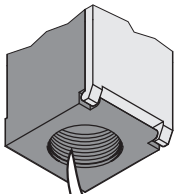

M20 CABLE ENTRY

For types with PG13.5 cable entry, add the letter P at the end of the order code while for 1/2 NPT, add N. E.g. KBH1S11P - KBH1S11N

Order code Plastic body	Metal body	Contacts	Rod material	Qty per pkg n°	Wt [kg]
-------------------------	------------	----------	--------------	----------------	---------

One bottom cable entry. Dimensions to EN/BS 50047.

KBH1S11	KMH1S11	1NO+1NC Snap action ①	Ceramic	5	②
KBH1S02	KMH1S02	2NC Snap action ①	Ceramic	5	②
KBH1A11	KMH1A11	1NO+1NC Slow action make before break ①	Ceramic	5	②
KBH1L11	KMH1L11	1NO+1NC Slow action ①	Ceramic	5	②
KBH1L02	KMH1L02	2NC Slow action ①	Ceramic	5	②
KBH1L20	KMH1L20	2NO Slow action	Ceramic	5	②
KBH1L12	KMH1L12	1NO+2NC Slow action ①	Ceramic	5	②
KBH1L21	KMH1L21	2NO+1NC Slow action ①	Ceramic	5	②
KBH1L03	KMH1L03	3NC Slow action ①	Ceramic	5	②

Two side cable entries. Dimensions compatible to EN/BS 50047.

KCH1S11	KNH1S11	1NO+1NC Snap action ①	Ceramic	5	②
KCH1S02	KNH1S02	2NC Snap action ①	Ceramic	5	②
KCH1A11	KNH1A11	1NO+1NC Slow action make before break ①	Ceramic	5	②
KCH1L11	KNH1L11	1NO+1NC Slow action ①	Ceramic	5	②
KCH1L02	KNH1L02	2NC Slow action ①	Ceramic	5	②
KCH1L20	KNH1L20	2NO Slow action	Ceramic	5	②

① Direct (positive) opening action ☺; safety function according to IEC/EN/BS 60947-5-1.

② Consult Technical support for information; see contact details on inside cover.

General characteristics

The LOVATO Electric limit switches have been designed to satisfy requirements comprising quick installation, easy wiring, simple setup, modularity, sturdiness and constant reliability.

The body cover is hinged at the bottom and removable.

The innovative locking bayonet mechanism permits to remove and reposition the operating head in the required configuration with no tools. The heads have axial rotation of 45° angles.

The auxiliary contact blocks are removable assuring remarkable wiring ease.

Operational characteristics

- Maximum operating rate: 3600 cycles/h
- Switching speed: 0.5...1.5m/s
- Mechanical life: >10 million cycles
- IEC conventional thermal current Ith: 10A
- UL/CSA and IEC/EN/BS 60947-5-1 designation:
 - A600 Q300 for KB...-KC... types
 - A300 Q300 for KM...-KN... types
- IEC rated insulation voltage Ui:
 - 690VAC for KB...-KC... types
 - 440VAC for KM...-KN... types
- IEC rated impulse withstand voltage Uimp:
 - 6kV for KB...-KC... types
 - 4kV for KM...-KN... types
- Class II insulation for KB...-KC... only
- Contact resistance: <10mΩ
- Short-circuit backup protection: 10A gG/SC quick fuse
- Operators of aluminium-zinc alloy
- Housing:
 - KB...-KC... types: self-extinguishing double-insulation polymer thermoplastic
 - KM...-KN... types: aluminium-zinc alloy
- Cable entry: M20 standard supplied; PG13.5 and 1/2 NPT available (see the side note for details)
- Operating head fixing: locking bayonet insert
- Operating torque: 3Ncm/4.25ozin
- Cable connection: self-releasing screw terminal
- Tightening torque:
 - Switch fixing: 2.5Nm / 22.1lb.in
 - Contact terminals: 0.8Nm / 7lb.in
 - Body lid screw fixing: 0.8Nm / 7lb.in
- Conductor section: 1 or 2 2.5mm² max / 16-14AWG
- Ambient conditions:
 - Operating temperature: -25...+70°C
 - Storage temperature: -40...+70°C
 - Pollution degree: 3
 - IEC degree of protection: IP20 for terminals
 - IEC degree of protection: IP65 for body housing.

Certifications and compliance

Certifications obtained: UL Listed for USA and Canada (cULus - File E93601), as Auxiliary Devices - Limit switches; EAC, CCC.

Compliant with standards: EN/BS 50047, IEC/EN/BS 60947-1, IEC/EN/BS 60947-5-1, IEC/EN/BS 60204-1, UL508, CSA C22.2 n° 14.

- ▶ Forward travel of snap action contacts
- ◀ Return travel of snap action contacts

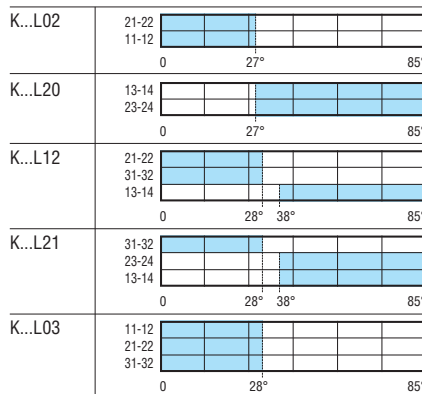
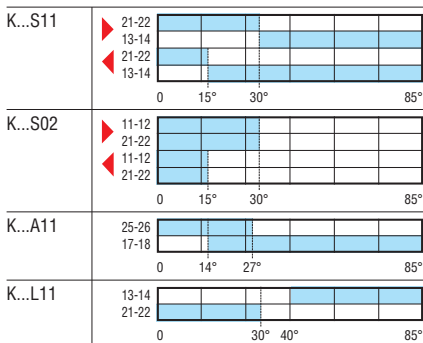

9 Limit, micro and foot switches

Limit switches, K series. One bottom cable entry. Dimensions to EN/BS 50047
Two side cable entries. Dimensions compatible to EN/BS 50047

Adjustable rod lever



KBL... - KML...

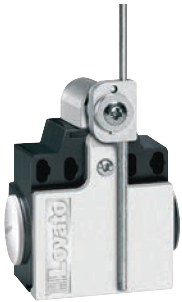

KCL... - KNL...

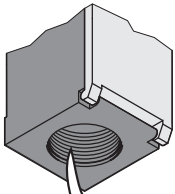

M20 CABLE ENTRY

For types with PG13.5 cable entry, add the letter P at the end of the order code while for 1/2 NPT, add N. E.g. KBL1S11P - KBL1S11N

Order code Plastic body	Metal body	Contacts	Rod material	Qty per pkg	Wt n° [kg]
-------------------------------	---------------	----------	-----------------	-------------------	------------------

One bottom cable entry. Dimensions to EN/BS 50047.

KBL1S11	KML1S11	1NO+1NC	Plastic	5	⊕
KBL2S11	KML2S11	Snap action⊕	Steel	5	⊕
KBL1S02	KML1S02	2NC	Plastic	5	⊕
KBL2S02	KML2S02	Snap action⊕	Steel	5	⊕
KBL1A11	KML1A11	1NO+1NC	Plastic	5	⊕
KBL2A11	KML2A11	Slow action make before break⊕	Steel	5	⊕
KBL1L11	KML1L11	1NO+1NC	Plastic	5	⊕
KBL2L11	KML2L11	Slow action⊕	Steel	5	⊕
KBL1L02	KML1L02	2NC	Plastic	5	⊕
KBL2L02	KML2L02	Slow action⊕	Steel	5	⊕
KBL1L20	KML1L20	2NO	Plastic	5	⊕
KBL2L20	KML2L20	Slow action	Steel	5	⊕
KBL1L12	KML1L12	1NO+2NC	Plastic	5	⊕
KBL2L12	KML2L12	Slow action⊕	Steel	5	⊕
KBL1L21	KML1L21	2NO+1NC	Plastic	5	⊕
KBL2L21	KML2L21	Slow action⊕	Steel	5	⊕
KBL1L03	KML1L03	3NC	Plastic	5	⊕
KBL2L03	KML2L03	Slow action⊕	Steel	5	⊕

Two side cable entries. Dimensions compatible to EN/BS 50047.

KCL1S11	KNL1S11	1NO+1NC	Plastic	5	⊕
KCL2S11	KNL2S11	Snap action⊕	Steel	5	⊕
KCL1S02	KNL1S02	2NC	Plastic	5	⊕
KCL2S02	KNL2S02	Snap action⊕	Steel	5	⊕
KCL1A11	KNL1A11	1NO+1NC	Plastic	5	⊕
KCL2A11	KNL2A11	Slow action make before break⊕	Steel	5	⊕
KCL1L11	KNL1L11	1NO+1NC	Plastic	5	⊕
KCL2L11	KNL2L11	Slow action⊕	Steel	5	⊕
KCL1L02	KNL1L02	2NC	Plastic	5	⊕
KCL2L02	KNL2L02	Slow action⊕	Steel	5	⊕
KCL1L20	KNL1L20	2NO	Plastic	5	⊕
KCL2L20	KNL2L20	Slow action	Steel	5	⊕

BI-DIRECTIONAL.

One bottom cable entry. Dimensions to EN/BS 50047.

KBL1D02	KML1D02	2NC ⊕ independent	Plastic⊕	5	⊕
KBL2D02	KML2D02	2NC ⊕ independent	Steel⊕	5	⊕

⊕ Direct (positive) opening action ⊖; safety function according to IEC/EN/BS 60947-5-1.

⊕ Consult Technical support for information; see contact details on inside cover.

General characteristics

The LOVATO Electric limit switches have been designed to satisfy requirements comprising quick installation, easy wiring, simple setup, modularity, sturdiness and constant reliability.

The body cover is hinged at the bottom and removable. The innovative locking bayonet mechanism permits to remove and reposition the operating head in the required configuration with no tools. The heads have axial rotation of 90° angles (180° for KC... and KN... types). The auxiliary contact blocks are removable assuring remarkable wiring ease.

Operational characteristics

- Maximum operating rate: 3600 cycles/h
- Switching speed: 0.5...1.5m/s
- Mechanical life: >10 million cycles
- IEC conventional thermal current Ith: 10A
- UL/CSA and IEC/EN/BS 60947-5-1 designation:
 - A600 Q300 for KB...-KC... types
 - A300 Q300 for KM...-KN... types
- IEC rated insulation voltage Ui:
 - 690VAC for KB...-KC... types
 - 440VAC for KM...-KN... types
- IEC rated impulse withstand voltage Uimp:
 - 6kV for KB...-KC... types
 - 4kV for KM...-KN... types
- Class II insulation for KB...-KC... only
- Contact resistance: <10mΩ
- Short-circuit backup protection: 10A gG/SC quick fuse
- Operators of aluminium-zinc alloy
- Housing:
 - KB...-KC... types: self-extinguishing double-insulation polymer thermoplastic
 - KM...-KN... types: aluminium-zinc alloy
- Cable entry: M20 standard supplied; PG13.5 and 1/2 NPT available (see the side note for details)
- Operating head fixing: locking bayonet insert
- Operating force: 3Ncm/4.25ozin
- Cable connection: self-releasing screw terminal
- Tightening torque:
 - Switch fixing: 2.5Nm / 22.1lb.in
 - Contact terminals: 0.8Nm / 7lb.in
 - Body lid screw fixing: 0.8Nm / 7lb.in
- Conductor section: 1 or 2 2.5mm² max / 16-14AWG
- Ambient conditions:
 - Operating temperature: -25...+70°C
 - Storage temperature: -40...+70°C
 - Pollution degree: 3
 - IEC degree of protection: IP20 for terminals
 - IEC degree of protection: IP65 for body housing.

Certifications and compliance

Certifications obtained: UL Listed for USA and Canada (cULus - File E93601), as Auxiliary Devices - Limit switches; EAC, CCC.

Compliant with standards: EN/BS 50047, IEC/EN/BS 60947-1, IEC/EN/BS 60947-5-1, IEC/EN/BS 60204-1, UL508, CSA C22.2 n° 14.

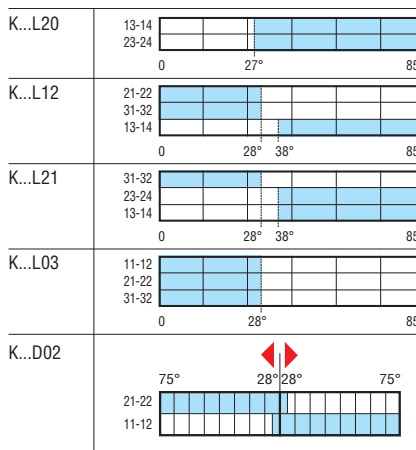
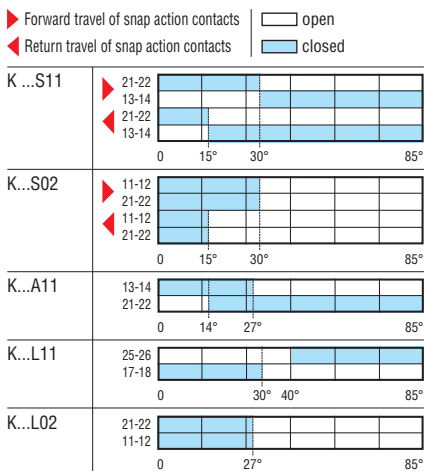

9 Limit, micro and foot switches

Limit switches, K series. One bottom cable entry. Dimensions to EN/BS 50047
Two side cable entries. Dimensions compatible to EN/BS 50047

Wobble stick, omnidirectional



KBM1... - KMM1...



KCM2... - KNM2...

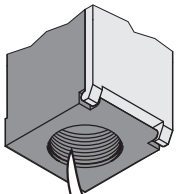

M20 CABLE ENTRY

For types with PG13.5 cable entry, add the letter P at the end of the order code while for 1/2 NPT, add N. E.g. KBM1S11P - KBM1S11N

Order code Plastic body	Order code Metal body	Contacts	Rod material	Qty per pkg n°	Wt [kg]
One bottom cable entry. Dimensions to EN/BS 50047.					
KBM1S11	KMM1S11	1NO+1NC	Flexible	5	ⓘ
KBM2S11	KMM2S11	Snap action	Semirigid	5	ⓘ
KBM1S02	KMM1S02	2NC	Flexible	5	ⓘ
KBM2S02	KMM2S02	Snap action	Semirigid	5	ⓘ
KBM1A11	KMM1A11	1NO+1NC	Flexible	5	ⓘ
KBM2A11	KMM2A11	Slow action make before break	Semirigid	5	ⓘ
KBM1L11	KMM1L11	1NO+1NC	Flexible	5	ⓘ
KBM2L11	KMM2L11	Slow action	Semirigid	5	ⓘ
KBM1L02	KMM1L02	2NC	Flexible	5	ⓘ
KBM2L02	KMM2L02	Slow action	Semirigid	5	ⓘ
KBM1L20	KMM1L20	2NO	Flexible	5	ⓘ
KBM2L20	KMM2L20	Slow action	Semirigid	5	ⓘ
KBM1L12	KMM1L12	1NO+2NC	Flexible	5	ⓘ
KBM2L12	KMM2L12	Slow action	Semirigid	5	ⓘ
KBM1L21	KMM1L21	2NO+1NC	Flexible	5	ⓘ
KBM2L21	KMM2L21	Slow action	Semirigid	5	ⓘ
KBM1L03	KMM1L03	3NC	Flexible	5	ⓘ
KBM2L03	KMM2L03	Slow action	Semirigid	5	ⓘ

Two side cable entries. Dimensions compatible to EN/BS 50047.

KCM1S11	KNM1S11	1NO+1NC	Flexible	5	ⓘ
KCM2S11	KNM2S11	Snap action	Semirigid	5	ⓘ
KCM1S02	KNM1S02	2NC	Flexible	5	ⓘ
KCM2S02	KNM2S02	Snap action	Semirigid	5	ⓘ
KCM1A11	KNM1A11	1NO+1NC	Flexible	5	ⓘ
KCM2A11	KNM2A11	Slow action make before break	Semirigid	5	ⓘ
KCM1L11	KNM1L11	1NO+1NC	Flexible	5	ⓘ
KCM2L11	KNM2 L11	Slow action	Semirigid	5	ⓘ
KCM1L02	KNM1L02	2NC	Flexible	5	ⓘ
KCM2L02	KNM2L02	Slow action	Semirigid	5	ⓘ
KCM1L20	KNM1L20	2NO	Flexible	5	ⓘ
KCM2L20	KNM2L20	Slow action	Semirigid	5	ⓘ

ⓘ Consult Technical support for information; see contact details on inside cover.

General characteristics

The LOVATO Electric limit switches have been designed to satisfy requirements comprising quick installation, easy wiring, simple setup, modularity, sturdiness and constant reliability.

The body cover is hinged at the bottom and removable. The innovative locking bayonet mechanism permits to remove and reposition the operating head in the required configuration with no tools. The auxiliary contact blocks are removable assuring remarkable wiring ease.

Operational characteristics

- Maximum operating rate: 3600 cycles/h
- Switching speed: 0.5...1.5m/s
- Mechanical life: >10 million cycles
- IEC conventional thermal current Ith: 10A
- UL/CSA and IEC/EN/BS 60947-5-1 designation:
 - A600 Q300 for KB...-KC... types
 - A300 Q300 for KM...-KN... types
- IEC rated insulation voltage Ui:
 - 690VAC for KB...-KC... types
 - 440VAC for KM...-KN... types
- IEC rated impulse withstand voltage Uimp:
 - 6kV for KB...-KC... types
 - 4kV for KM...-KN... types
- Class II insulation for KB...-KC... only
- Contact resistance: <10mΩ
- Short-circuit backup protection: 10A gG/SC quick fuse
- Operators of aluminium-zinc alloy
- Housing:
 - KB...-KC... types: self-extinguishing double-insulation polymer thermoplastic
 - KM...-KN... types: aluminium-zinc alloy
- Cable entry: M20 standard supplied; PG13.5 and 1/2 NPT available (see the side note for details)
- Operating head fixing: locking bayonet insert
- Operating torque: 1Ncm/1.42ozin
- Cable connection: self-releasing screw terminal
- Tightening torque:
 - Switch fixing: 2.5Nm / 22.1lb.in
 - Contact terminals: 0.8Nm / 7lb.in
 - Body lid screw fixing: 0.8Nm / 7lb.in
- Conductor section: 1 or 2 2.5mm² max / 16-14AWG
- Ambient conditions:
 - Operating temperature: -25...+70°C
 - Storage temperature: -40...+70°C
 - Pollution degree: 3
 - IEC degree of protection: IP20 for terminals
 - IEC degree of protection: IP65 for body housing.

Certifications and compliance

Certifications obtained: UL Listed for USA and Canada (cULus - File E93601), as Auxiliary Devices - Limit switches; EAC, CCC.
Compliant with standards: EN/BS 50047, IEC/EN/BS 60947-1, IEC/EN/BS 60947-5-1, IEC/EN/BS 60204-1, UL508, CSA C22.2 n° 14.

▶ Forward travel of snap action contacts □ open
◀ Return travel of snap action contacts ■ closed

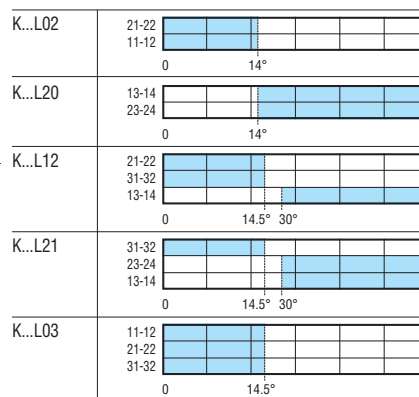
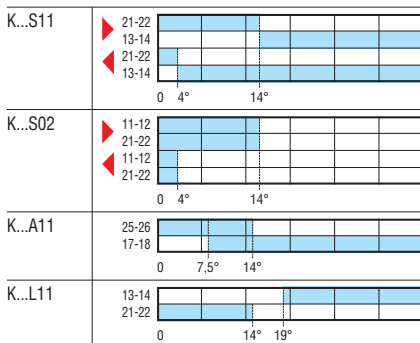

9 Limit, micro and foot switches

Limit switches, K series. One bottom cable entry. Dimensions to EN/BS 50047
Two side cable entries. Dimensions compatible to EN/BS 50047

Hinge operating



KBP... - KMP...



KCP... - KNP...

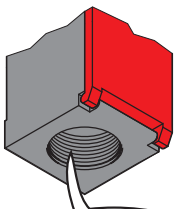

M20 CABLE ENTRY

For types with PG13.5 cable entry, add the letter P at the end of the order code while for 1/2 NPT, add N. E.g. KBP1L11P - KBP1L11N

Order code	Plastic body	Metal body	Contacts	Shaft features	Qty per pkg	Wt
					n°	[kg]

One bottom cable entry. Dimensions to EN/BS 50047.

KBP1L11	KMP1L11	1NO+1NC Slow action Ⓢ	Short cylinder	5	Ⓢ
KBP2L11	KMP2L11	1NO+1NC Slow action Ⓢ	Long solid	5	Ⓢ
KBP3L11	KMP3L11	1NO+1NC Slow action Ⓢ	Long solid w/ reduction	5	Ⓢ
KBP1L02	KMP1L02	2NC Slow action Ⓢ	Short cylinder	5	Ⓢ
KBP2L02	KMP2L02	2NC Slow action Ⓢ	Long solid	5	Ⓢ
KBP3L02	KMP3L02	2NC Slow action Ⓢ	Long solid w/ reduction	5	Ⓢ
KBP1L12	KMP1L12	1NO+2NC Slow action Ⓢ	Short cylinder	5	Ⓢ
KBP2L12	KMP2L12	1NO+2NC Slow action Ⓢ	Long solid	5	Ⓢ
KBP3L12	KMP3L12	1NO+2NC Slow action Ⓢ	Long solid w/ reduction	5	Ⓢ
KBP1L21	KMP1L21	2NO+1NC Slow action Ⓢ	Short cylinder	5	Ⓢ
KBP2L21	KMP2L21	2NO+1NC Slow action Ⓢ	Long solid	5	Ⓢ
KBP3L21	KMP3L21	2NO+1NC Slow action Ⓢ	Long solid w/ reduction	5	Ⓢ
KBP1L03	KMP1L03	3NC Slow action Ⓢ	Short cylinder	5	Ⓢ
KBP2L03	KMP2L03	3NC Slow action Ⓢ	Long solid	5	Ⓢ
KBP3L03	KMP3L03	3NC Slow action Ⓢ	Long solid w/ reduction	5	Ⓢ

Two side cable entries. Dimensions compatible to EN/BS 50047.

KCP1L11	KNP1L11	1NO+1NC Slow action Ⓢ	Short cylinder	5	Ⓢ
KCP2L02	KNP2L02	1NO+1NC Slow action Ⓢ	Long solid	5	Ⓢ
KCP3L11	KNP3L11	1NO+1NC Slow action Ⓢ	Long solid w/ reduction	5	Ⓢ
KCP1L02	KNP1L02	2NC Slow action Ⓢ	Short cylinder	5	Ⓢ
KCP2L02	KNP2L02	2NC Slow action Ⓢ	Long solid	5	Ⓢ
KCP3L02	KNP3L02	2NC Slow action Ⓢ	Long solid w/ reduction	5	Ⓢ

Ⓢ Direct (positive) opening action ⊖; safety function according to IEC/EN/BS 60947-5-1.

Ⓢ Consult Technical support for information; see contact details on inside cover.

General characteristics

The LOVATO Electric limit switches have been designed to satisfy requirements comprising quick installation, easy wiring, simple setup, modularity, sturdiness and constant reliability.

The body cover is hinged at the bottom and removable. The innovative locking bayonet mechanism permits to remove and reposition the operating head in the required configuration with no tools.

The auxiliary contact blocks are removable assuring remarkable wiring ease.

Operational characteristics

- Maximum operating rate: 3600 cycles/h
- Switching speed: 0.5...1.5m/s
- Mechanical life: 100,000 cycles
- B10d: 100,000 cycles
- IEC conventional thermal current Ith: 10A
- UL/CSA and IEC/EN/BS 60947-5-1 designation:
 - A600 Q300 for KB...-KC... types
 - A300 Q300 for KM...-KN... types
- IEC rated insulation voltage Ui:
 - 690VAC for KB...-KC... types
 - 440VAC for KM...-KN... types
- IEC rated impulse withstand voltage Uimp:
 - 6kV for KB...-KC... types
 - 4kV for KM...-KN... types
- Class II insulation for KB...-KC... only
- Contact resistance: <10mΩ
- Short-circuit backup protection: 10A gG/SC quick fuse
- Operators of aluminium-zinc alloy
- Housing:
 - KB...-KC... types: self-extinguishing double-insulation polymer thermoplastic
 - KM...-KN... types: aluminium-zinc alloy
- Cable entry: M20 standard supplied; PG13.5 and 1/2 NPT available (see the side note for details)
- Operating head fixing: locking bayonet insert
- Operating torque: 15Ncm/21.2ozin
- Cable connection: self-releasing screw terminal
- Tightening torque:
 - Switch fixing: 2.5Nm / 22.1lb.in
 - Contact terminals: 0.8Nm / 7lb.in
 - Body lid screw fixing: 0.8Nm / 7lb.in
- Conductor section: 1 or 2 2.5mm² max / 16-14AWG
- Ambient conditions:
 - Operating temperature: -25...+70°C
 - Storage temperature: -40...+70°C
 - Pollution degree: 3
 - IEC degree of protection: IP20 for terminals
 - IEC degree of protection: IP65 for body housing.

Certifications and compliance

Certifications obtained: UL Listed for USA and Canada (cULus - File E93601), as Auxiliary Devices - Limit switches; EAC, CCC.

Compliant with standards: EN/BS 50047, IEC/EN/BS 60947-1, IEC/EN/BS 60947-5-1, IEC/EN/BS 60204-1, UL508, CSA C22.2 n° 14.

□ open
■ closed

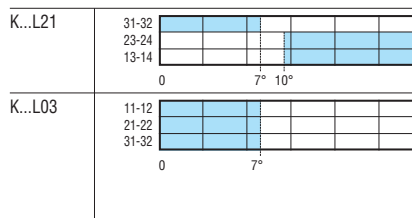
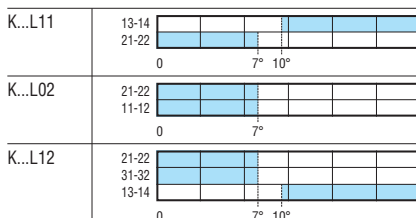

9 Limit, micro and foot switches

Limit switches, K series. One bottom cable entry. Dimensions to EN/BS 50047
Two side cable entries. Dimensions compatible to EN/BS 50047

Slotted lever

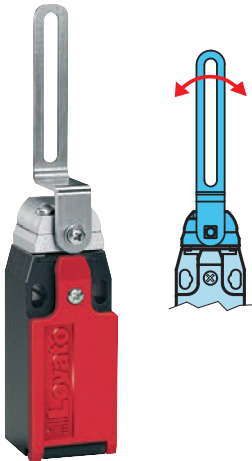

KBQ... - KMQ...

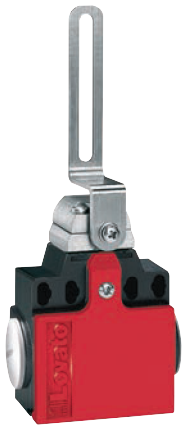

KCQ... - KNQ...

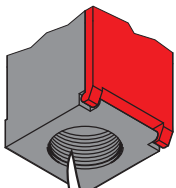

M20 CABLE ENTRY

For types with PG13.5 cable entry, add the letter P at the end of the order code while for 1/2 NPT, add N. E.g. KBQ1L11P - KBQ1L11N

Order code Plastic body	Metal body	Contacts	Qty per pkg	Wt [kg]
One bottom cable entry. Dimensions to EN/BS 50047.				
KBQ1L11	KMQ1L11	1NO+1NC Slow action ①	5	②
KBQ1L02	KMQ1L02	2NC Slow action ①	5	②
KBQ1L12	KMQ1L12	1NO+2NC Slow action ①	5	②
KBQ1L21	KMQ1L21	2NO+1NC Slow action ①	5	②
KBQ1L03	KMQ1L03	3NC Slow action ①	5	②

Order code Plastic body	Metal body	Contacts	Qty per pkg	Wt [kg]
Two side cable entries. Dimensions compatible to EN/BS 50047.				
KCQ1L11	KNQ1L11	1NO+1NC Slow action ①	5	②
KCQ1L02	KNQ1L02	2NC Slow action ①	5	②

① Direct (positive) opening action \ominus ; safety function according to IEC/EN/BS 60947-5-1.
② Consult Technical support for information; see contact details on inside cover.

General characteristics

The LOVATO Electric limit switches have been designed to satisfy requirements comprising quick installation, easy wiring, simple setup, modularity, sturdiness and constant reliability.

The body cover is hinged at the bottom and removable. The innovative locking bayonet mechanism permits to remove and reposition the operating head in the required configuration with no tools. The auxiliary contact blocks are removable assuring remarkable wiring ease.

Operational characteristics

- Maximum operating rate: 3600 cycles/h
- Switching speed: 0.5...1.5m/s
- Mechanical life: 100,000 cycles
- B10d: 100,000 cycles
- IEC conventional thermal current Ith: 10A
- UL/CSA and IEC/EN/BS 60947-5-1 designation:
 - A600 Q300 for KB...-KC... types
 - A300 Q300 for KM...-KN... types
- IEC rated insulation voltage Ui:
 - 690VAC for KB...-KC... types
 - 440VAC for KM...-KN... types
- IEC rated impulse withstand voltage Uimp:
 - 6kV for KB...-KC... types
 - 4kV for KM...-KN... types
- Class II insulation for KB...-KC... only
- Contact resistance: <10mΩ
- Short-circuit backup protection: 10A gG/SC quick fuse
- Operators of aluminium-zinc alloy
- Housing:
 - KB...-KC... types: self-extinguishing double-insulation polymer thermoplastic
 - KM...-KN... types: aluminium-zinc alloy
- Cable entry: M20 standard supplied; PG13.5 and 1/2 NPT available (see the side note for details)
- Operating head fixing: locking bayonet insert
- Operating torque: 15Ncm/21.2ozin
- Cable connection: self-releasing screw terminal
- Tightening torque:
 - Switch fixing: 2.5Nm / 22.1lb.in
 - Contact terminals: 0.8Nm / 7lb.in
 - Body lid screw fixing: 0.8Nm / 7lb.in
- Conductor section: 1 or 2 2.5mm² max / 16-14AWG
- Ambient conditions:
 - Operating temperature: -25...+70°C
 - Storage temperature: -40...+70°C
 - Pollution degree: 3
 - IEC degree of protection: IP20 for terminals
 - IEC degree of protection: IP65 for body housing.

Certifications and compliance

Certifications obtained: UL Listed for USA and Canada (cULus - File E93601), as Auxiliary Devices - Limit switches; EAC, CCC.
Compliant with standards: EN/BS 50047, IEC/EN/BS 60947-1, IEC/EN/BS 60947-5-1, IEC/EN/BS 60204-1, UL508, CSA C22.2 n° 14.

□ open
■ closed

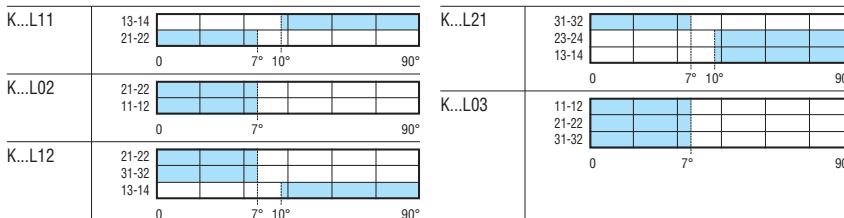

9 Limit, micro and foot switches

Limit switches, K series. One bottom cable entry. Dimensions to EN/BS 50047
Two side cable entries. Dimensions compatible to EN/BS 50047

Key operated



KBN...



KCN...

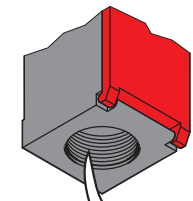

M20 CABLE ENTRY

For types with PG13.5 cable entry, add the letter P at the end of the order code while for 1/2 NPT, add N. E.g. KBN1L11P - KBN1L11N

□ open
■ closed

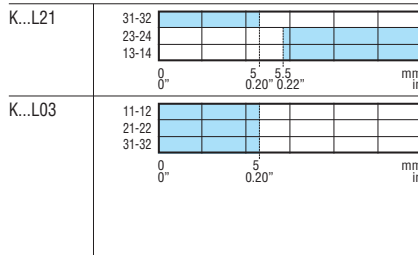
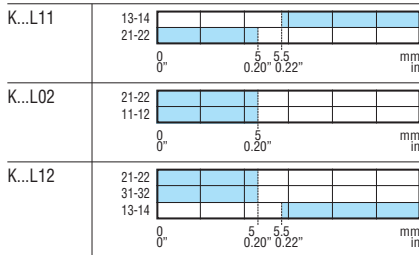

Order code Plastic body	Contacts	Key shape [⊕]	Qty per pkg n°	Wt [kg]
----------------------------	----------	------------------------	-------------------	------------

One bottom cable entry. Dimensions to EN/BS 50047.

KBN1L11	1NO+1NC	Straight	5	0.092
KBN2L11	Slow action [⊖]	Angled	5	0.092
KBN3L11		Straight "T"	5	0.092
KBN4L11		Angled "T"	5	0.092
KBN1L02		2NC	Straight	5
KBN2L02	Slow action [⊖]	Angled	5	0.092
KBN3L02		Straight "T"	5	0.092
KBN4L02		Angled "T"	5	0.092
KBN1L12		1NO+2NC	Straight	5
KBN2L12	Slow action [⊖]	Angled	5	0.096
KBN3L12		Straight "T"	5	0.096
KBN4L12		Angled "T"	5	0.096
KBN1L21	2NO+1NC	Straight	5	0.096
KBN2L21	Slow action [⊖]	Angled	5	0.096
KBN3L21		Straight "T"	5	0.096
KBN4L21		Angled "T"	5	0.096
KBN1L03	3NC	Straight	5	0.096
KBN2L03	Slow action [⊖]	Angled	5	0.096
KBN3L03		Straight "T"	5	0.096
KBN4L03		Angled "T"	5	0.096

Two side cable entries. Dimensions compatible to EN/BS 50047.

KCN1L11	1NO+1NC	Straight	5	0.107
KCN2L11	Slow action [⊖]	Angled	5	0.107
KCN3L11		Straight "T"	5	0.107
KCN4L11		Angled "T"	5	0.107
KCN1L02	2NC	Straight	5	0.107
KCN2L02	Slow action [⊖]	Angled	5	0.107
KCN3L02		Straight "T"	5	0.107
KCN4L02		Angled "T"	5	0.107

⊕ Direct (positive) opening action ⊖; safety function according to IEC/EN/BS 60947-5-1.

⊕ The key is standard supplied.

General characteristics

The LOVATO Electric limit switches have been designed to satisfy requirements comprising quick installation, easy wiring, simple setup, modularity, sturdiness and constant reliability.

The body cover is hinged at the bottom and removable. The heads have axial rotation in any of 4 positions at 90° angles.

The auxiliary contact blocks are removable assuring remarkable wiring ease.

Operational characteristics

- Maximum operating rate: 3600 cycles/h
- Switching speed: 0.5...1.5m/s
- Mechanical life: 100,000 cycles
- B10d: 100,000 cycles
- IEC conventional thermal current Ith: 10A
- UL/CSA and IEC/EN/BS 60947-5-1 designation:
 - A600 Q600
- IEC rated insulation voltage Ui: 690V
- IEC rated impulse withstand voltage Uimp: 6kV
- Class II insulation
- Contact resistance: <10mΩ
- Short-circuit backup protection: 10A gG/SC quick fuse
- Housing and operators in self-extinguishing double-insulation polymer thermoplastic
- Cable entry: M20 standard supplied; PG13.5 and 1/2 NPT available (see the side note for details)
- Operating head fixing: locking bayonet insert
- Operating force: 8N/1.8lb
- Cable connection: self-releasing screw terminal
- Tightening torque:
 - Switch fixing: 2.5Nm / 22.1lb.in
 - Contact terminals: 0.8Nm / 7lb.in
 - Body lid screw fixing: 0.8Nm / 7lb.in
- Conductor section: 1 or 2 2.5mm² max / 16-14AWG
- Ambient conditions:
 - Operating temperature: -25...+70°C
 - Storage temperature: -40...+70°C
 - Pollution degree: 3
 - IEC degree of protection: IP20 for terminals
 - IEC degree of protection: IP65 for body housing.

Certifications and compliance

Certifications obtained: UL Listed for USA and Canada (cULus - File E93601), as Auxiliary Devices - Limit switches; EAC, CCC.

Compliant with standards: EN/BS 50047, IEC/EN/BS 60947-1, IEC/EN/BS 60947-5-1, IEC/EN/BS 60204-1, UL508, CSA C22.2 n° 14.

Accessories and spare parts for key operated switches



KXN1



KXN2



KXN3



KXN4



KXN5

Order code	Description	Qty per pkg n°	Wt [kg]
KXN1	Straight key	5	0.013
KXN2	Angled key	5	0.013
KXN3	Straight "T" key	5	0.012
KXN4	Angled "T" key	5	0.012
KXN5	Toggle key	5	0.019

9 Limit, micro and foot switches

Limit switches, K series.

Accessories and spare parts for KB - KC - KM and KN type limit switches



INDEX

Contact blocks



KXB...

Order code	Contacts	Qty per pkg	Wt [kg]
KXBS11	1NO+1NC Snap action ^{①②}	5	0.022
KXBS02	2NC Snap action ^{①②}	5	0.022
KXBA11	1NO+1NC Slow action make before break ^{①②}	5	0.022
KXBL11	1NO+1NC Slow action ^②	5	0.022
KXBL02	2NC Slow action ^②	5	0.022
KXBL20	2NO Slow action	5	0.022
KXBL12	1NO+2NC Slow action ^{②③}	5	0.026
KXBL21	2NO+1NC Slow action ^{②③}	5	0.026
KXBL03	3NC Slow action ^{②③}	5	0.026

- ① Not suitable for key operated KBN / KCN, hinged operating KBP / KCP / KMP / KNP and slotted lever KBQ / KCQ / KMQ / KNQ types.
- ② Direct (positive) opening action ; safety function according to IEC/EN/BS 60947-5-1.
- ③ Not suitable for KC and KN types, KG and KR foot switches.

Body complete with contact block



KXCB... - KXCM...



KXCC... - KXCN...

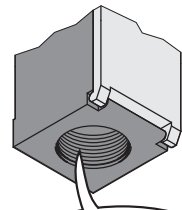

M20 CABLE ENTRY

For types with PG13.5 cable entry, add the letter P at the end of the order code while for 1/2 NPT, add N. E.g. KXCCL11P - KXCCL11N

Order code Plastic body	Order code Metal body	Contacts	Qty per pkg	Wt [kg]
-------------------------	-----------------------	----------	-------------	---------

One bottom cable entry. Dimensions to EN/BS 50047.

KXCBS11	KXCMS11	1NO+1NC Snap action ^{①②}	5	④
KXCBS02	KXCMS02	2NC Snap action ^{①②}	5	④
KXCBA11	KXCMA11	1NO+1NC Slow action make before break ^{①②}	5	④
KXCBL11	KXCML11	1NO+1NC Slow action ^②	5	④
KXCBL02	KXCML02	2NC Slow action ^②	5	④
KXCBL20	KXCML20	2NO Slow action	5	④
KXCBL12	KXCML12	1NO+2NC Slow action ^{②③}	5	④
KXCBL21	KXCML21	2NO+1NC Slow action ^{②③}	5	④
KXCBL03	KXCML03	3NC Slow action ^{②③}	5	④

Two side cable entries. Dimensions compatible to EN/BS 50047.

KXCNS11	KXCNS11	1NO+1NC Snap action ^{①②}	5	④
KXCNS02	KXCNS02	2NC Snap action ^{①②}	5	④
KXCNA11	KXCNA11	1NO+1NC Slow action make before break ^{①②}	5	④
KXCCL11	KXCCL11	1NO+1NC Slow action ^②	5	④
KXCCL02	KXCCL02	2NC Slow action ^②	5	④
KXCCL20	KXCCL20	2NO Slow action	5	④

- ① Not suitable for key operated KBN / KCN, hinged operating KBP / KCP / KMP / KNP and slotted lever KBQ / KCQ / KMQ / KNQ types.
- ② Direct (positive) opening action ; safety function according to IEC/EN/BS 60947-5-1.
- ③ Not suitable for KC and KN types.
- ④ Consult Technical support for information; see contact details on inside cover.

General characteristics

The KXB... contact blocks can be used with the K series of limit switches. Combinations of 2 contacts with slow or snap action and, for KB... and KM... types only, 3 slow action contacts are available.

The NC contacts have direct opening operation, a specific safety principle.

The particular four-point contacts warrant high conductivity in any sort of application. The removal of the contacts from the limit switch body provides remarkable wiring ease and reduces installation time as well.

The KXC... bodies, complete with auxiliary contacts, can be used as spare parts for the K series limit switches or coupled with the KXA... operating heads, to obtain complete limit switches in the required configurations.

The body cover is hinged at the bottom and removable to have the best access. Each body includes the innovative locking bayonet mechanism of the operating head. Plastic and metal types are available.

Operational characteristics

- Mechanical life: >10 million cycles
- IEC conventional thermal current Ith: 10A
- Conductivity: 10mA 5V
- UL/CSA and IEC/EN/BS 60947-5-1 designation:
 - A600 Q300 for KXCB...-KXCC... types
 - A300 Q300 for KXCM...-KXCN... types
- IEC rated insulation voltage Ui:
 - 690VAC for KXCB...-KXCC... types
 - 440VAC for KXCM...-KXCN... types
- IEC rated impulse withstand voltage Uimp:
 - 6kV for KXCB...-KXCC... types
 - 4kV for KXCM...-KXCN... types
- Class II insulation for KXCB...-KXCC... only
- Contact resistance: <10mΩ
- Short-circuit backup protection: 10A gG/SC quick fuse
- Housing:
 - KXCB...-KXCC... types: self-extinguishing double-insulation polymer thermoplastic
 - KXCM...-KXCN... types: aluminium-zinc alloy
- Cable entry: M20 standard supplied; PG13.5 and 1/2 NPT available (see the side note for details)
- Operating head fixing: locking bayonet insert
- Cable connection: self-releasing screw terminal
- Tightening torque:
 - Switch fixing: 2.5Nm / 22.1lb.in
 - Contact terminals: 0.8Nm / 7lb.in
 - Body lid screw fixing: 0.8Nm / 7lb.in
- Conductor section: 1 or 2 2.5mm² max / 16-14AWG
- Ambient conditions:
 - Operating temperature: -25...+70°C
 - Storage temperature: -40...+70°C
 - Pollution degree: 3
 - IEC degree of protection: IP20 for terminals
 - IEC degree of protection: IP65 for body housing.

Certifications and compliance

Certifications obtained: UL Listed for US and Canada (File E93601), as Auxiliary Devices for KX C... body types only. UL Recognized for USA and Canada (cURus - File E93601) as component - Auxiliary devices for contact blocks only; products having this type of marking are intended for use as components of complete workshop-assembled equipment; EAC for all.

Comply with standards: EN/BS50047, IEC/EN/BS 60947-1, IEC/EN/BS 60947-5-1, IEC/EN/BS 60204-1, UL508, CSA C22.2 n° 14.

- ▶ Forward travel of snap action contacts open
- ◀ Return travel of snap action contacts closed

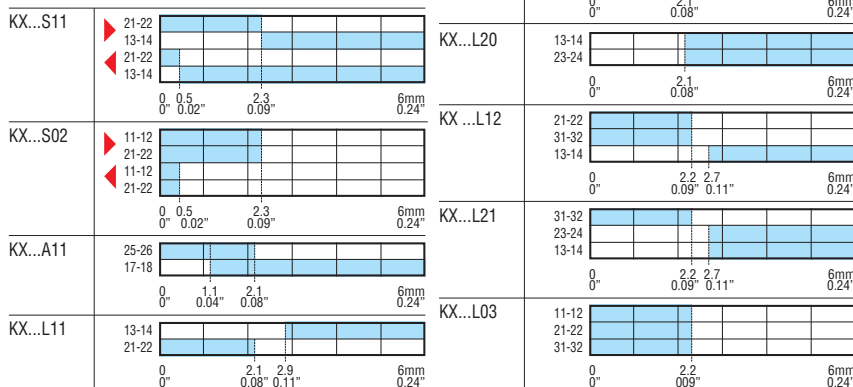

9 Limit, micro and foot switches

Limit switches, K series.

Accessories and spare parts for KB, KC, KM and KN type limit switches

Operating heads

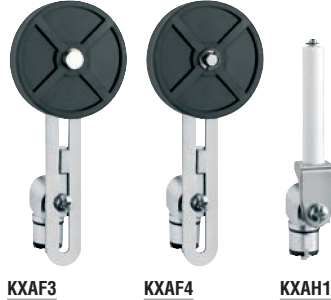
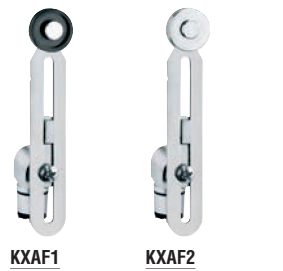

Order code	Description	Qty per pkg	Wt
		n°	[kg]
KXAA1	Top push rod plunger	5	0.013
KXAB1	Plastic top roller push plunger	5	0.019
KXAB2	Metal top roller push plunger	5	0.020
KXAC1	Plastic roller centre push lever	5	0.018
KXAC2	Metal roller centre push lever	5	0.022
KXAD1	Plastic roller side push lever	5	0.018
KXAD2	Metal roller side push lever	5	0.023
KXAE1	Plastic roller lever plunger	5	0.039
KXAE2	Metal roller lever plunger	5	0.048
KXAE3	Rubber Ø50x10mm roller lever plunger	5	0.058
KXAF1	Adjustable plastic roller lever Ø19x5mm ①	5	0.055
KXAF2	Adjustable metal roller lever Ø19x5mm ①	5	0.065
KXAF3	Adjustable rubber Ø50x10mm roller lever	5	0.072
KXAF4	Adjustable offset rubber Ø50x10mm roller lever	5	0.081
KXAH1	Ceramic rod lever	5	0.056
KXAL1	Adjustable plastic rod lever	5	0.043
KXAL2	Adjustable stainless steel rod lever	5	0.051
KXAM1	Flexible wobble stick	5	0.032
KXAM2	Semirigid wobble stick	5	0.023

① Ø19x5mm = Ø0.75"x0.2".

② Ø50x10mm = Ø1.97"x0.39".

General characteristics

The KXA... operating heads can be used as spare parts for the K series limit switches or coupled with the KXC... bodies to obtain complete limit switches in the required configurations.

The heads are made of metal and warrant sturdiness and operating reliability in all conditions.

The shape of the coupling section with the body of the K series switches permits to orient the head in any 45° angle position while the initial lever and rod position can be adjusted 360° at 15° angle positions.

The head fixing to the body is achieved by the innovative locking bayonet mechanism so there is no need of tools. Tightening torque for eventual operating head actuator fixing is 0.8Nm/7lb.in.

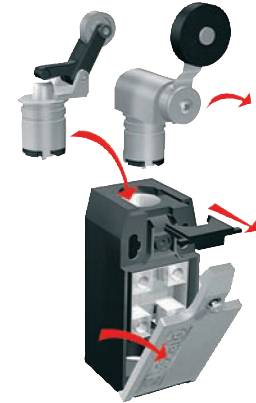

Cable glands and cable conduit



Order code	Description	Qty per pkg	Wt
		n°	[kg]
KXP01	M20 cable gland	50	0.009
KXP02	PG13.5 cable gland	50	0.009
KXP03	M20 rubber cable conduit	50	0.004

General characteristics

The cable glands are in plastic with either M20 or PG13.5 thread and provide to keep the cable in place and maintain the proper IP protection of the limit switch after installation.

Operational characteristics for cable gland

- Material: self-extinguishing polyamide
- IEC degree of protection: IP68
- Gland seal with cable diameter: 6...12mm/0.24...0.47".

Certifications and compliance

Certifications obtained: EAC.
Compliant with standards: EN/BS 50262, UL508.



KPA1... KPA2...



KPB1... KPB2...



KPB3... KPB4...



KPE5... KPE6...



KPF7... KPF8...



KPE1... KPE2...



KPF1... KPL2...

Order code	Contacts 1NO+1NC	Head material	Cable length ⊕	Qty per pkg	Wt [kg]
			m	n°	

TOP PUSH ROD PLUNGER.

KPA1S11	Snap action ⊕	Metal	2	1	0.286
KPA1L11	Slow action ⊕	Metal	2	1	0.286
KPA2S11⊕	Snap action ⊕	Metal	2	1	0.302
KPA2L11⊕	Slow action ⊕	Metal	2	1	0.302

TOP ROLLER PUSH PLUNGER.

KPB1S11	Snap action ⊕	Plastic	2	1	0.290
KPB1L11	Slow action ⊕	Plastic	2	1	0.290
KPB2S11	Snap action ⊕	Metal	2	1	0.290
KPB2L11	Slow action ⊕	Metal	2	1	0.290
KPB3S11⊕	Snap action ⊕	Plastic	2	1	0.288
KPB3L11⊕	Slow action ⊕	Plastic	2	1	0.288
KPB4S11⊕	Snap action ⊕	Metal	2	1	0.296
KPB4L11⊕	Slow action ⊕	Metal	2	1	0.296

M12 HEAD TOP ROLLER PUSH PLUNGER.

KPB5S11	Snap action ⊕	Plastic	2	1	0.308
KPB5L11	Slow action ⊕	Plastic	2	1	0.308
KPB6S11	Snap action ⊕	Metal	2	1	0.310
KPB6L11	Slow action ⊕	Metal	2	1	0.310
KPB7S11⊕	Snap action ⊕	Plastic	2	1	0.310
KPB7L11⊕	Slow action ⊕	Plastic	2	1	0.310
KPB8S11⊕	Snap action ⊕	Metal	2	1	0.310
KPB8L11⊕	Slow action ⊕	Metal	2	1	0.310

ROLLER LEVER PLUNGER.

KPE1S11	Snap action ⊕	Plastic	2	1	0.336
KPE1L11	Slow action ⊕	Plastic	2	1	0.336
KPE2S11	Snap action ⊕	Metal	2	1	0.336
KPE2L11	Slow action ⊕	Metal	2	1	0.336

ADJUSTABLE ROLLER LEVER.

KPF1S11	Snap action ⊕	Plastic	2	1	0.344
KPF1L11	Slow action ⊕	Plastic	2	1	0.344

ADJUSTABLE ROD LEVER.

KPL2S11	Snap action ⊕	Metal	2	1	0.342
KPL2L11	Slow action ⊕	Metal	2	1	0.342

OMNIDIRECTIONAL WOBBLE STICK.

KPM2S11	Snap action ⊕	Metal	2	1	0.298
---------	---------------	-------	---	---	-------

- ⊕ Direct (positive) opening action ⊖; safety function according to IEC/EN/BS 60947-5-1.
- ⊕ For prewired switches with 1m long cable only, add suffix 010 at the end of the order code.
Example: KPA1S11010 for prewired switch, top push metal rod plunger, with 1NO+1NC snap action contacts and 1m long cable.
- ⊕ M12 head fixing.
- ⊕ Roller operation perpendicular to switch body.

Operational characteristics

- 2 meters long cable ⊕ (5 core, each 0.75mm²/18 AWG)
- Maximum operating rate: 3600 cycles/h
- Mechanical life: >10 million cycles
- IEC conventional thermal current Ith: 10A
- conductivity: 10mA 5V
- UL/CSA and IEC/EN/BS 60947-5-1 designation: B300 R300
- IEC rated insulation voltage Ui: 400VAC
- IEC rated impulse withstand voltage Uimp: 4kV
- Class I insulation
- Contact resistance: <25mΩ
- Body housing: aluminium and zinc alloy
- Operating force/torque:
 - KPA types: 15N / 3.4lb
 - KPB types: 10N / 2.2lb
 - KPE, KPF and KPL types: 0.08Nm / 0.7lb.in
 - KPM types: 0.1Nm / 0.9lb.in
- Tightening torque for switch fixing: 2.5Nm / 22.1lb.in for body housing fixing possible: 0.8Nm / 7lb.in
- Ambient conditions:
 - Operating temperature: -25...+70°C
 - Storage temperature: -40...+70°C
 - Pollution degree: 3
 - IEC degree of protection: IP67 for body housing.

Certifications and compliance

Certifications obtained: UL Listed for USA and Canada (cULus - File E93601), as Auxiliary Devices - Limit switches; EAC.
Compliant with standards: IEC/EN/BS 60947-1, IEC/EN/BS 60947-5-1, UL508, CSA C22.2 n° 14.

- ▶ Forward travel of snap action contacts | open
- ◀ Return travel of snap action contacts | closed

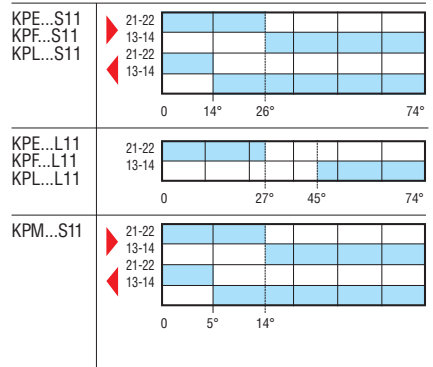
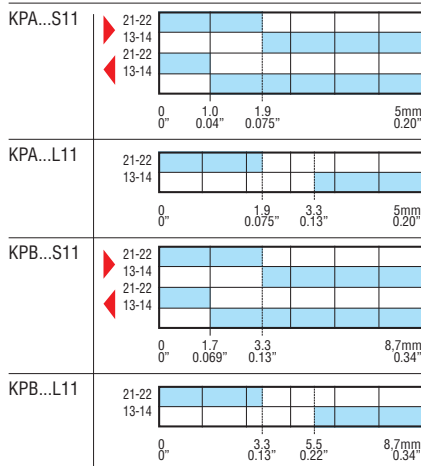

9 Limit, micro and foot switches

Metal limit switches, PL series

Top push rod plunger



PLN...A...

Order code	Contacts	Degree of protection	Qty per pkg	Wt [kg]
		IEC	n°	
PLNA1A	1NCⓘ	IP40	1	0.240
PLNA1AW		IP65	1	0.240
PLNA2A	2NCⓘ	IP40	1	0.240
PLNA2AW		IP65	1	0.240
PLNC1A	1NO	IP40	1	0.240
PLNC1AW		IP65	1	0.240
PLNC2A	2NO	IP40	1	0.240
PLNC2AW		IP65	1	0.240
PLNU1A	1NO+1NC	IP40	1	0.240
PLNU1AW		IP65	1	0.240

ⓘ Direct (positive) opening action ⊖; safety function according to IEC/EN/BS 60947-5-1.

Top roller push plunger



PLN...R...

Order code	Contacts	Degree of protection	Qty per pkg	Wt [kg]
		IEC	n°	
PLNA1R	1NCⓘ	IP40	1	0.230
PLNA1RW		IP65	1	0.230
PLNA2R	2NCⓘ	IP40	1	0.230
PLNA2RW		IP65	1	0.230
PLNC1R	1NO	IP40	1	0.230
PLNC1RW		IP65	1	0.230
PLNC2R	2NO	IP40	1	0.230
PLNC2RW		IP65	1	0.230
PLNU1R	1NO+1NC	IP40	1	0.230
PLNU1RW		IP65	1	0.230

ⓘ Direct (positive) opening action ⊖; safety function according to IEC/EN/BS 60947-5-1.

Roller centre push lever



PLN...H

Order code	Contacts	Degree of protection	Qty per pkg	Wt [kg]
		IEC	n°	
PLNA1H	1NCⓘ	IP40	1	0.270
PLNA1HW		IP65	1	0.270
PLNA2H	2NCⓘ	IP40	1	0.270
PLNA2HW		IP65	1	0.270
PLNU1H	1NO+1NC	IP40	1	0.270
PLNU1HW		IP65	1	0.270
With offset roller.				
PLNA1HSB	1NCⓘ	IP40	1	0.290
PLNA1HSBW		IP65	1	0.290
PLNA2HSB	2NCⓘ	IP40	1	0.290
PLNA2HSBW		IP65	1	0.290
PLNU1HSB	1NO+1NC	IP40	1	0.290
PLNU1HSBW		IP65	1	0.290

ⓘ Direct (positive) opening action ⊖; safety function according to IEC/EN/BS 60947-5-1.



PLN...HSBW

Type	Travel [mm (in)]	Legend
PLNA1A... PLNA1R...	11-12 1.5 0.06" 11.5 0.45" [mm (in)]	□ open ■ closed
PLNA1H... PLNA1HSB...	11-12 2.4 0.09" 20 0.79" [mm (in)]	
PLNA2A... PLNA2R...	11-12 21-22 1.5 0.06" 6.5 0.25" [mm (in)]	
PLNA2H... PLNA2HSB...	11-12 21-22 2.4 0.09" 11.5 0.45" [mm (in)]	
PLNC1A... PLNC1R...	13-14 2.2 0.09" 11.5 0.45" [mm (in)]	
PLNC2A... PLNC2R...	13-14 23-24 4.2 0.16" 6.4 0.25" [mm (in)]	
PLNU1A... PLNU1R...	21-22 13-14 1.5 0.06" 11.5 0.45" 5.9 (0.23") [mm (in)]	
PLNU1H... PLNU1HSB...	21-22 13-14 2.4 0.09" 20 0.79" 10.4 (0.41") [mm (in)]	

General characteristics

The PL types are for general purpose use. The extensive range of models with numerous actuators and multiple contact configurations is the optimal solution to the diverse installation requirements.

Overall simple design, oversize contacts and choice materials ensure durable and safe operation. The metal alloy housing and resistant thermoplastic actuators warrant reliable heavy-duty features for any sort of operating conditions.

The PL series limit switches are available with IEC IP40 or IP65 degree of protection; this characteristic is ensured by the use of appropriate sealing gasket.

The IEC IP65 version is easily identified by the "W" suffix of its order code and can be used in adverse ambient conditions.

Operational characteristics

- Maximum operating rate: 3600 cycles/h
- Mechanical life: >10 million cycles
- IEC utilisation category:
 - DC13 duty: 10A 24V
 - AC15 duty: 5A 250V, 3A 400V
- IEC conventional thermal current Ith: 10A
- IEC rated insulation voltage Ui: 400VAC
- Contact resistance: <10mΩ
- Short-circuit backup protection: 10A gG/SC quick fuse
- Housing cable entry: PG11 (PLN...W types only complete with cable gland)
- Cable connection: screw terminal with clamp suitable for cables up to 2.5mm² / 14 AWG
- Tightening torque:
 - Switch fixing: 2.5Nm / 22.1lb.in
 - Contact terminals: 0.8Nm / 7lb.in
 - Body lid screw fixing: 0.8Nm / 7lb.in
- Ambient conditions:
 - Operating temperature: -25...+70°C
 - Storage temperature: -40...+70°C
 - Pollution degree: 3
 - IEC degree of protection: IP40 / IP65 (see table indications).

Certifications and compliance

Certifications obtained: IMQ, EAC.
Compliant with standards: IEC/EN/BS 60947-1, IEC/EN/BS 60947-5-1, EN/BS 81-1.

9 Limit, micro and foot switches

Metal limit switches, PL series



INDEX

Latch and manual release



PLNA1RAG

Order code	Contacts	Degree of protection	Qty per pkg	Wt
		IEC	n°	[kg]

Top roller push plunger.

PLNA1RAG	1NC	IP40	1	0.220
PLNA1RAGW	1NC	IP65	1	0.230

Direct (positive) opening action ; safety function according to IEC/EN/BS 60947-5-1.

Manual reload and magnetic release



PLA1AM

Order code	Contacts	Degree of protection	Qty per pkg	Wt
		IEC	n°	[kg]

Top push rod plunger.

PLA1AM	1NC	IP40	1	0.245
PLA1AMW	1NC	IP65	1	0.250

Top roller push plunger.

PLA1RM	1NC	IP40	1	0.250
PLA1RMW	1NC	IP65	1	0.260

Direct (positive) opening action ; safety function according to IEC/EN/BS 60947-5-1.



PLA1RMW

Bi-directional



PLN978

Order code	Contacts	Degree of protection	Qty per pkg	Wt
		IEC	n°	[kg]

Rod plunger.

PLN978	2NC independent	IP65	1	0.265
---------------	--------------------	------	---	-------

Direct (positive) opening action ; safety function according to IEC/EN/BS 60947-5-1.

Type	Travel [mm (in)] (The arrows indicate the direction of operation)	open closed
PLNA1RAG PLNA1RAGW	 1 0.04" 0.27" 7 21-22 [mm (in)]	
PLA1AM PLA1AMW PLA1RM PLA1RMW	 0.5 0.02" 0.31" 8 21-22 [mm (in)]	
PLN978	 8 0.31" 0.5 0.02" 0.02" 0.5 0.31" 8 11-12 21-22 [mm (in)]	

General characteristics

The PL limit switches were initially made specifically for hoisting or lifting duty and then used in other diverse applications. The type with latch and manual release as well as the one with manual reload and magnetic release are designed so the switch remains opened after the switching of the NC contact. In the first instance, the contact closing is made by pushing the release button. In the second case, the reloading is obtained by pushing the shaft end or else pulling it from the top for the IP65 types.

The limit switches with dual operation can be replaced by two standard switches, for the stop control of moving mechanisms with two directions of running (e.g. automatic doors). It is equipped with two opposed operating mechanisms and one NC contact for each mechanism (i.e. 2NC).

The simple constructive design, oversize contacts and careful material combinations warrant safe and constant operation. The metal-alloy housing and the thermoplastic mechanism material of first-rate mechanical features assure reliability and durability with any type of operating condition.

Operational characteristics

- Maximum operating rate: 3600 cycles/h
- Mechanical life: >10 million cycles
- IEC utilisation category:
 - DC13 duty: 10A 24V
 - AC15 duty: 5A 250V, 3A 400V
- IEC conventional thermal current I_{th}: 10A
- IEC rated insulation voltage: 400VAC
- Contact resistance: <10mΩ
- Short-circuit backup protection: 10A gG/SC quick fuse
- Housing cable entry: PG11 (PL...W and PLN978 types only complete with cable gland)
- Cable connection: screw terminal with clamp suitable for cables up to 2.5mm² / 14 AWG
- Tightening torque:
 - Switch fixing: 2.5Nm / 22.1lb.in
 - Contact terminals: 0.8Nm / 7lb.in
 - Body lid screw fixing: 0.8Nm / 7lb.in
- Ambient conditions:
 - Operating temperature: -25...+70°C
 - Storage temperature: -40...+70°C
 - Pollution degree: 3
 - IEC degree of protection: IP40 / IP65 (see table indications).

Certifications and compliance

Certifications obtained: IMQ, EAC.
Compliant with standards: IEC/EN/BS 60947-5-1, IEC/EN/BS 60204-1, EN/BS 81-1.

9 Limit, micro and foot switches

Rope-pull lever limit switches for normal stopping

Dimensions to EN/BS 50047



RS113... - RS213... - RS313...

Order code	Contacts	Ring material	Qty per pkg	Wt
			n°	[kg]
Without reset button.				
RS11310	1NO+1NC Snap action	Steel	1	0.090
RS21310	1NO+1NC Slow action	Steel	1	0.090
RS31310	2NO Slow action	Steel	1	0.090

Type	▶ Forward travel of snap action contacts	□ open
	◀ Return travel of snap action contacts	■ closed
RS113...	▶ 21-22 13-14 ◀ 21-22 13-14	
RS213...	21-22 13-14	
RS313...	21-22 11-12	

General characteristics

The RS series limit switches are designed and manufactured according to European standards for dimensions and operating characteristics.

The double-insulated housing of the limit switch is made of glass-reinforced self-extinguishing polyamide resin to protect internal circuits against shocks or impacts and in industrial environments, against accidental ingress of tools and accidental contact.

The contacts are dimensioned to ensure self cleaning of the silver-alloy contact surfaces.

Operational characteristics

- Maximum operating rate: 3600 cycles/h for RS...13
- Switching speed: 0.5...1.5m/s
- Mechanical life: >10 million cycles
- IEC utilisation category:
 - DC13 duty: 1.5A 24V
 - AC15 duty: 6A 250V
- IEC conventional thermal current Ith: 10A
- IEC rated insulation voltage Ui: 250VAC
- Contact resistance: <10mΩ
- Short-circuit backup protection: 10A gG/SC quick fuse
- Operating force: 25N/5.6lb
- Cable entry: PG11 (RS...13)
- Cable connection: self-releasing screw terminal
- Tightening torque:
 - Switch fixing: 2.5Nm / 22.1lb.in
 - Contact terminals: 0.8Nm / 7lb.in
 - Body lid screw fixing: 0.8Nm / 7lb.in
- Conductor section: 1 or 2 2.5mm² max / 16-14 AWG
- Ambient conditions:
 - Operating temperature: -25...+70°C
 - Storage temperature: -40...+70°C
 - Pollution degree: 3
 - IEC degree of protection: IP65 (RS...13).

Certifications and compliance

Certifications obtained: UL Listed for USA and Canada (cULus - File E93601), as Auxiliary Devices - Limit switches; EAC.

Compliant with standards: IEC/EN/BS 60947-1, IEC/EN/BS 60947-5-1, IEC/EN/BS 60204-1, EN/BS 81-1, EN/BS 50041, UL508, CSA C22.2 n° 14.

9 Limit, micro and foot switches

Rope-pull lever limit switches for normal stopping



PLN...AT...W

Order code	Contacts	Degree of protection	Operating force	Qty per pkg	Wt
		IEC	[N] / [lb]	n°	[kg]
Without reset button					
PLNU1AT	1NO+1NC	IP40	10 / 2.2	1	0.240
PLNU1ATW	①	IP65	10 / 2.2	1	0.240
PLNU1AT25	1NO+1NC	IP40	25 / 5.6	1	0.240
PLNU1AT25W	①	IP65	25 / 5.6	1	0.240

① Direct (positive) opening action ⊖; safety function according to IEC/EN/BS 60947-5-1.

Order code	Contacts	Degree of protection	Operating force	Qty per pkg	Wt
		IEC	[N] / [lb]	n°	[kg]
Without reset button.					
P2L81311	1NO+1NC	IP65	40 / 9	1	0.459
P2L81312	①	IP65	120 / 27	1	0.459
P2L101311	2NO+2NC	IP65	40 / 9	1	0.459
P2L101312	①	IP65	120 / 27	1	0.459

① Direct (positive) opening action ⊖; safety function according to IEC/EN/BS 60947-5-1.



P2L...

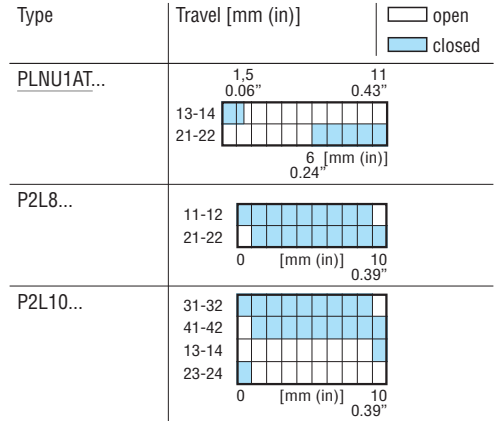

General characteristics

The PLN and P2L types are limit switches for general use. The simple constructive design, oversize contacts and careful material combinations warrant safe and constant operation. The metal-alloy housing and the thermoplastic mechanism material of first-rate mechanical features assure reliability and durability with any type of operating condition.

Operational characteristics

- Maximum operating rate: 3600 cycles/h
- Mechanical life: >10 million cycles
- IEC utilisation category:
 - DC13 duty: 10A 24V
 - AC15 duty: 5A 250V; 3A 400V
- IEC conventional thermal current Ith: 10A for PLN types; 6A for P2L types
- IEC rated insulation voltage Ui: 400VAC
- Contact resistance: <10mΩ
- Short-circuit backup protection: 10A gG/SC quick fuse
- Cable entry: PG11 (PLN...W and P2L types only complete with cable gland)
- Cable connection: self-releasing screw terminal suitable for cables up to 2.5mm² / 14 AWG
- Tightening torque for switch fixing: 2.5Nm/2.21lb.in
- Ambient conditions:
 - Operating temperature: -25...+70°C
 - Storage temperature: -40...+70°C
 - Pollution degree: 3
 - IEC degree of protection: IP40 / IP65 (see order code table indications).

Certifications and compliance

Certifications obtained: IMQ.
Compliant with standards: IEC/EN/BS 60947-1, IEC/EN/BS 60947-5-1, EN/BS 81-1.

9 Limit, micro and foot switches

Rope-pull lever limit switches for emergency stopping, ISO 13850 compliant.
Accessories and spare parts



RS131310



PLN131311



P2L...

Accessories and spare parts



P33032



P33033



P33034



P33035



P33036

Order code	Contacts	Force	Qty per pkg	Wt
		[N]/[lb]	n°	[kg]
With reset button.				
RS131310	1NO + 1NC	25/5.6	1	0.092
PLN131311	1NO + 1NC	60/13.5	1	0.248
P2L131311	1NO + 1NC	40/9	1	0.459
P2L131312	1NO + 1NC	120/27	1	0.459
P2L151311	2NO + 2NC	40/9	1	0.459
P2L151312	2NO + 2NC	120/27	1	0.459

- ① Direct (positive) opening action \ominus ; safety function according to IEC/EN/BS 60947-5-1.
- ② Dimensions according with EN/BS 50047.
- ③ Dimensions according with EN/BS 50041.

Example of wiring diagram

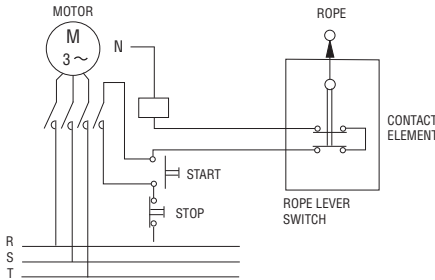

Type	Travel [mm (in)]	Legend
		□ open ■ closed
RS...	11-12 21-22 0 [mm (in)] 6 (0.24")	
PLN...	11-12 21-22 0 [mm (in)] 8 (0.31")	
P2L13...	11-12 21-22 0 [mm (in)] 10 (0.39")	
P2L15...	31-32 41-42 13-14 23-24 0 [mm (in)] 10 (0.39")	

General characteristics

The rope-operated switches for emergency stop are mainly suitable for emergency stop or alarm systems for machinery which occupies a large space. This emergency stop can be achieved from any point when the rope is manually pulled each time.

The choice of the body, between plastic and metal, can satisfy the most diversified requirements for sturdiness and size.

Operational characteristics

- Maximum operating rate: 1800 cycles/h
- Mechanical life: 100,000 cycles
- IEC utilisation category:
 - DC13 duty: 1.5A 24V (10A 24V only for PLN-P2L)
 - AC15 duty: 6A 250V (3A 400V only for PLN-P2L)
- IEC conventional thermal current Ith: 10A for RS and PLN; 6A for P2L
- IEC rated insulation voltage Ui: 250VAC (400V for PLN-P2L)
- Contact resistance: <10mΩ
- Short-circuit backup protection: 10A gG/SC quick fuse
- Cable entry: PG11 for RS, PLN and P2L types (PLN and P2L complete with cable gland)
- Cable connection: self-releasing screw terminal
- Tightening torque:
 - Switch fixing: 2.5Nm / 22.1lb.in
 - Contact terminals: 0.8Nm / 7lb.in (for RS), 1.8Nm / 15.9lb.in (for PL and P2L)
 - Body lid screw fixing: 0.8Nm / 7lb.in
- Conductor section: 1 or 2 2.5mm² max / 16-14 AWG
- Ambient conditions:
 - Operating temperature: -25...+70°C
 - Storage temperature: -40...+70°C
 - Pollution degree: 3
 - IEC degree of protection: IP65.

Operation

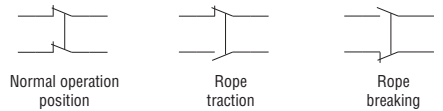

Certification and compliance

Certifications obtained: UL Listed for USA and Canada (cULus - File E93601), as Auxiliary Devices - Limit switches for RS13... types only; EAC for all.
Compliant with standards: IEC/EN/BS 60947-1, IEC/EN/BS 60947-5-1, IEC/EN/BS 60204-1, ISO 13850; also UL508, CSA-C22.2 n° 14 for RS types.

Safety switches with solenoid



KEN1...

Order code	Key actuated contacts ①	Solenoid actuated contacts ①	Solenoid rated voltage [V]	Qty per pkg n°	Wt [kg]
Locked actuator with energised solenoid ②					
KEN1E1024F	1NC	2NC+1NO	24V AC/DC	1	0.440
KEN1E2024F	1NA	2NC+1NO		1	0.440
KEN1E3024F	1NO+1NC	2NC		1	0.440
KEN1E1120F	1NC	2NC+1NO	120V AC/DC	1	0.440
KEN1E2120F	1NO	2NC+1NO		1	0.440
KEN1E3120F	1NO+1NC	2NC		1	0.440
KEN1E1230F	1NC	2NC+1NO	230V AC/DC	1	0.440
KEN1E2230F	1NO	2NC+1NO		1	0.440
KEN1E3230F	1NO+1NC	2NC		1	0.440
Locked actuator with de-energised solenoid ②					
KEN1M1024F	1NC	2NC+1NO	24V AC/DC	1	0.440
KEN1M2024F	1NO	2NC+1NO		1	0.440
KEN1M3024F	1NO+1NC	2NC		1	0.440
KEN1M1120F	1NC	2NC+1NO	120V AC/DC	1	0.440
KEN1M2120F	1NO	2NC+1NO		1	0.440
KEN1M3120F	1NO+1NC	2NC		1	0.440
KEN1M1230F	1NC	2NC+1NO	230V AC/DC	1	0.440
KEN1M2230F	1NO	2NC+1NO		1	0.440
KEN1M3230F	1NO+1NC	2NC		1	0.440

① Contacts status are referred to the operating condition (KEN1E...energised solenoid and inserted key actuator / KEN1M... de-energised solenoid and inserted key actuator).
② Key actuator has to be ordered separately

Keys



KEXN1



KEXN2



KEXN5

Order code	Description	Qty per pkg n°	Wt [kg]
KEXN1	Straight key	1	0.013
KEXN2	Angled key	1	0.013
KEXN5	Toggle key	1	0.019

ACTUATOR HAED ORIENTATION



Follow these steps in order to properly direct the actuator head of KEN... safety switches:

- Unscrew the 4 Ø2 Pozidriv 1 screws
- Remove the actuator
- Check the gasket is properly placed
- Put the actuator head in the desired position and press for fixing it into the case
- Screw the the 4 Ø2 Pozidriv 1 screws (tightening torque 0.8Nm / 7lb.in)
- Before start using the new configuration, repeat the functional tests of the system.

General characteristics

The safety switches with solenoid avoid access in hazardous areas until the receiving of an appropriate signal: the actuator key could be locked or released through a solenoid dependent upon it's powered state (locked actuator with energised solenoid for KEN1E.../locked actuator with de-energised solenoid for KEN1M...).

A manual emergency release is available.
Three different electric contact combinations are available. Contacts are actuated separately by key actuator or by solenoid and allow to cover the installations' main common needs.

Operational characteristics

- For safety applications up to:
 - Safety integrity level (SIL), category 3 according to EN/BS 62061
 - PLe according to EN/BS ISO 13849-1
- Interlock with mechanical lock Type 2 according to EN/BS ISO 14119.
- Actuator insertion force: 15N
- Release actuator extraction force: 30N
- Locked actuator holding force: 1200N
- Maximum operating rate: 600 cycles/h
- Mechanical life: 1.000.000 cycles
- B10d: 4.000.000 cycles
- IEC conventional thermal current: 10A
- IEC/EN/BS 60947-5-1 designation: A300 Q300
- AC15 duty:
 - 24V - 10A
 - 230V - 4A
- DC13 duty:
 - 24V - 4A
- IEC rated insulation voltage Ui: 250V
- Rated impulse withstand voltage: 2.5kV
- Short-circuit backup protection: 10A Gg
- Max solenoid consumption:
 - 24V: 8.3W
 - 120V: 8.1W
 - 230V: 6.8W
- IEC terminals degree of protection: IP20
- IEC body housing degree of protection: IP65
- Self-extinguishing polymer thermoplastic housing and actuator head
- Actuator head orientation can be modified by the user in 4 axial positions (90° step)
- Cables entries: 3 x M20
- Cable connection: self-releasing screw terminal
- Tightening torque:
 - Case cover: 0.8Nm / 7lb.in
 - Manual release: 0.5Nm / 4.3lb.in
 - Head actuator fixing: 0.8Nm / 7lb.in
 - Contact terminals: 0.5Nm / 4.3lb.in
 - Supply terminals: 0.5Nm / 4.3lb.in
- Conductor section: 1 or 2 conductors 1.5mm² max
- Ambient conditions:
 - Operating temperature: -25...+55°C
 - Storage temperature: -40...+70°C
 - Pollution degree: 3.

Certifications and compliance

Certifications obtained: cULus, EAC.
Compliant with standards: IEC/EN/BS 60947-1, IEC/EN/BS 60947-5-1, IEC/EN/BS 60204, UNI EN/BS ISO 14119, UL508, CSA C22.2 n°14.

9 Limit, micro and foot switches

Safety switches with solenoid and separate actuator

Key actuator status	KEN1E...: locked actuator with energised solenoid			KEN1M...: locked actuator with de-energised solenoid		
	inserted and locked	inserted and unlocked	not inserted	inserted and locked	inserted and unlocked	not inserted
Solenoid status	energised	de-energised	-	de-energised	energised	-

Contact activation

KEN1...1...	Key actuator	11 12	11 12	11 12	11 12	11 12	11 12
	Solenoid	21 22	21 22	21 22	21 22	21 22	21 22
	Solenoid	33 34	33 34	33 34	33 34	33 34	33 34
	Solenoid	41 42	41 42	41 42	41 42	41 42	41 42
KEN1...2...	Key actuator	13 14	13 14	13 14	13 14	13 14	13 14
	Solenoid	21 22	21 22	21 22	21 22	21 22	21 22
	Solenoid	33 34	33 34	33 34	33 34	33 34	33 34
	Solenoid	41 42	41 42	41 42	41 42	41 42	41 42
KEN1...3...	Key actuator	13 14	13 14	13 14	13 14	13 14	13 14
	Solenoid	21 22	21 22	21 22	21 22	21 22	21 22
	Key actuator	31 32	31 32	31 32	31 32	31 32	31 32
	Solenoid	41 42	41 42	41 42	41 42	41 42	41 42

9 Limit, micro and foot switches

Plastic micro switches.
Accessories

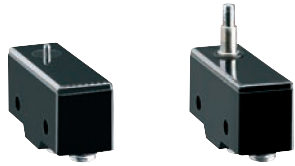

KSA1...

KSA2...



KSA3...

KSA4...

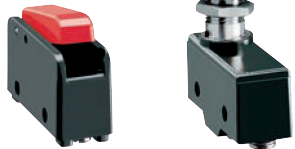

KSA9...

KSB1...

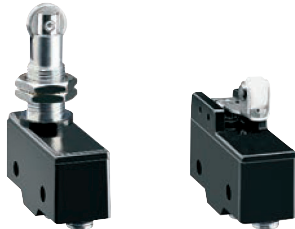

KSB2...

KSC1...

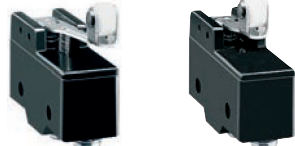

KSC2...

KSC3...

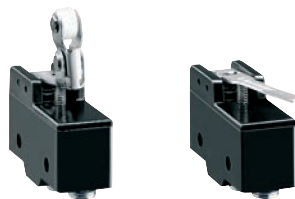

KSC9...

KSL1...

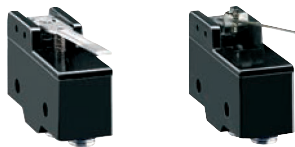

KSL2...

KSL3...

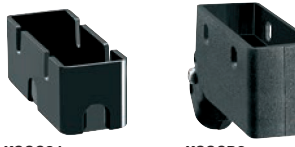

KSSC01

KSSCB2

Order code	Contacts	Terminals	Qty per pkg	Wt
			n°	[kg]
TOP PUSH ROD. METAL PLUNGER. Pin.				
KSA1S	1NO/NC	Solder	10	0.031
KSA1V	1NO/NC	Screw	10	0.031
KSA1F	1NO/NC	Faston	10	0.032
TOP PUSH ROD. METAL PLUNGER. High rod plunger.				
KSA2S	1NO/NC	Solder	10	0.033
KSA2V	1NO/NC	Screw	10	0.033
KSA2F	1NO/NC	Faston	10	0.034
TOP PUSH ROD. METAL PLUNGER. Low rod plunger.				
KSA3S	1NO/NC	Solder	10	0.033
KSA3V	1NO/NC	Screw	10	0.033
KSA3F	1NO/NC	Faston	10	0.035
TOP PUSH ROD. METAL PLUNGER. M12 fixing head.				
KSA4S	1NO/NC	Solder	10	0.052
KSA4V	1NO/NC	Screw	10	0.052
KSA4F	1NO/NC	Faston	10	0.053
PUSH BUTTON.				
KSA9S	1NO/NC	Solder	10	0.034
KSA9V	1NO/NC	Screw	10	0.034
KSA9F	1NO/NC	Faston	10	0.035
TOP ROLLER PUSH PLUNGER. M12 fixing head.				
KSB1S	1NO/NC	Solder	10	0.057
KSB1V	1NO/NC	Screw	10	0.057
KSB1F	1NO/NC	Faston	10	0.058
TOP ROLLER PUSH PLUNGER. M12 fixing head, 90° roller.				
KSB2S	1NO/NC	Solder	10	0.057
KSB2V	1NO/NC	Screw	10	0.057
KSB2F	1NO/NC	Faston	10	0.060
ROLLER CENTRE PUSH LEVER. 26.6mm/1.05" long lever.				
KSC1S	1NO/NC	Solder	10	0.036
KSC1V	1NO/NC	Screw	10	0.036
KSC1F	1NO/NC	Faston	10	0.037
ROLLER CENTRE PUSH LEVER. 48.5mm/1.91" long lever.				
KSC2S	1NO/NC	Solder	10	0.037
KSC2V	1NO/NC	Screw	10	0.037
KSC2F	1NO/NC	Faston	10	0.038
ROLLER CENTRE PUSH LEVER. 37mm/1.45" long lever.				
KSC3S	1NO/NC	Solder	10	0.037
KSC3V	1NO/NC	Screw	10	0.037
KSC3F	1NO/NC	Faston	10	0.038
ROLLER CENTRE PUSH LEVER. One-way roller lever.				
KSC9S	1NO/NC	Solder	10	0.038
KSC9V	1NO/NC	Screw	10	0.038
KSC9F	1NO/NC	Faston	10	0.039
METAL LEVER. 63mm/2.48" long flat lever.				
KSL1S	1NO/NC	Solder	10	0.035
KSL1V	1NO/NC	Screw	10	0.035
KSL1F	1NO/NC	Faston	10	0.037
METAL LEVER. 54mm/2.13" long flat lever.				
KSL2S	1NO/NC	Solder	10	0.035
KSL2V	1NO/NC	Screw	10	0.035
KSL2F	1NO/NC	Faston	10	0.037
METAL LEVER. 168.3mm/6.63" long flat cylindrical lever.				
KSL3S	1NO/NC	Solder	10	0.037
KSL3V	1NO/NC	Screw	10	0.037
KSL3F	1NO/NC	Faston	10	0.038
ACCESSORIES. ❶				
KSSC01	Terminal shroud		10	0.007
KSSCB2	Terminal shroud with conduit		10	0.015

❶ Suitable only for KS...V.

Operational characteristics

- Maximum operating rate: 240 cycles/min
- Switching speed: 0.01...1m/s
- Operating speed: 0.05...1m/s
- Electrical life: 500,000 cycles
- Mechanical life: 20 million cycles
- IEC conventional thermal current Ith: 15A
- UL/CSA and IEC/EN/BS 60947-5-1 designation: A600 P300
- Conductivity: 10mA 5V
- IEC rating: AC15 240VAC 3A
- IEC rated insulation voltage Ui: 250VAC
- Contact resistance: <15mΩ
- Body housing: polymer thermoplastic
- Operating force:
 - KSA1-KSA4 and KSB types: 2.5N/9oz
 - KSA9 and KSC3 types: 1.5N/5.4oz
 - KSC1 types: 1N/3.6oz
 - KSC2 and KSL2: 1.3N/4.7oz
 - KSC9 types: 1.7N/6.1oz
 - KSL1 types: 6.4N/23oz
 - KSL3 types: 0.1N/0.36oz
- Tightening torque:
 - For M12 head fixing: 4.9...6.9Nm/43...61lb.in
 - For side screws: 0.6...1Nm/5.3...8.8lb.in
 - For terminal screws: 0.7...1Nm/6.2...8.8lb.in
- Ambient conditions:
 - Operating temperature: -25...+70°C
 - Storage temperature: -40...+70°C
 - Pollution degree: 3
 - IEC degree of protection: IP00 or IP20 with terminal shroud.

Certifications and compliance

Certifications obtained: UL Recognized for USA and Canada (File E172189) as Industrial Control Switches - Component; products having this type of marking are intended for use as components of complete workshop - assembled equipment; EAC.
Compliance with standards: IEC/EN/BS 60947-1, IEC/EN/BS 60947-5-1, IEC/EN/BS 61058-1, UL508, CSA C22.2 n° 14.

9 Limit, micro and foot switches

Foot switches.
Accessories



KG200 ...
KG220 ...



KR200 ...



KG110 ...



KR210 ...
KR211 ...

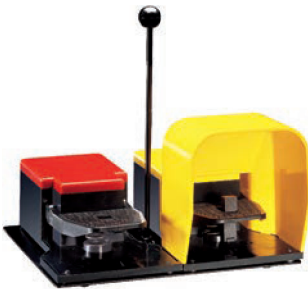

KGD003 - KGD004

- ① Direct (positive) opening action \ominus ; safety function according to IEC/EN/BS 60947-5-1.
- ② Consult Technical support for information; see contact details on inside cover.
- ③ A possible second contact block can be fitted; blocks with only 2 contacts in total can be used. See accessories below.

Accessories



KXP...



KXP03

- ④ A possible second contact block can be fitted on the left-hand pedal; blocks with only 2 contacts in total can be used. See accessories below and contact blocks on page 9-16.

Order code Plastic body	Metal body	Model	Contacts	Qty per pkg	Wt
				n°	[kg]

ONE PEDAL FOOT SWITCHES. With free actuation.

KG100S11 ③	KR100S11 ③	Open	1NO+1NC Snap action ①	1	②
KG100L11 ③	KR100L11 ③	Open	1NO+1NC Slow action ①	1	②
KG200S11 ③	KR200S11 ③	With cover	1NO+1NC Snap action ①	1	②
KG200L11 ③	KR200L11 ③	With cover	1NO+1NC Slow action ①	1	②

With safety lever.

KG110S11 ③	KR110S11 ③	Open	1NO+1NC Snap action ①	1	②
KG110L11 ③	KR110L11 ③	Open	1NO+1NC Slow action ①	1	②
KG210S11 ③	KR210S11 ③	With cover	1NO+1NC Snap action ①	1	②
KG210L11 ③	KR210L11 ③	With cover	1NO+1NC Slow action ①	1	②
KG210S22 ③	KR210S22 ③	With cover	2NO+2NC Snap action ①	1	②

With pedal actuator lock.

KG120S11 ③	KR120S11 ③	Open	1NO+1NC Snap action ①	1	②
KG120L11 ③	KR120L11 ③	Open	1NO+1NC Slow action ①	1	②
KG220S11 ③	KR220S11 ③	With cover	1NO+1NC Snap action ①	1	②
KG220L11 ③	KR220L11 ③	With cover	1NO+1NC Slow action ①	1	②

With two-stage safety lever.

KG211S22 ③	KR211S22 ③	With cover	2NO+2NC 2-stage snap action ①	1	②
---------------	---------------	---------------	-------------------------------------	---	---

Order code Plastic body	Metal body	Model	Contacts (for each pedal)	Qty per pkg	Wt
				n°	[kg]

TWO PEDAL FOOT SWITCHES. With safety lever on both pedals.

KGD001 ③	KRD001 ③	Both w/cover	1NO+1NC Snap action ①	1	②
KGD002 ③	KRD002 ③	Both w/cover	2NO+2NC Snap action ①	1	②

Left pedal with free actuation and right pedal with safety lever.

KGD003 ③	KRD003 ③	Left open Right w/cover	1NO+1NC Snap action ①	1	②
KGD004 ④	KRD004 ④	Left open Right w/cover	1NO+1NC Snap action ① 2NO+2NC Snap action ①	1	②

General characteristics

The KG... and KR... foot switches are used to control machinery and other equipment, leaving the operator's hands free to do other functions. The sturdiness of the metal and plastic body and the wide range of the available versions provide the proper solution for each control need.

Main features are:

- Thermoplastic or metal version.
The plastic or metal body gives adequate robustness to the foot switch, for installation in all ambient and application conditions.
- Versions complete with or without pedal protection cover.
The cover assures protection against accidental foot switch operation, due to sudden tool or heavy material dropping or other shock or vibration. The type without cover, open version, is instead immediately accessible and is preferred when the most important pedal operation is to stop a machine.
- Versions with safety lever.
The safety mechanism prevents unintentional foot switch activation and excludes the pedal pressing if the operator's foot is not completely in place.
- Stable pedal base.
The foot switch is equipped with rubber feet and metal-reinforced base for a firm and non-sliding position and a more reliable and safe activation.

Operational characteristics

- Mechanical life: >10 million cycles
- Conventional thermal current Ith: 10A
- Designation to IEC/EN/BS 60947-5-1:
 - A600 Q600 for KG types
 - A300 Q300 for KR types
- Tightening torque for contacts: 1Nm/8.8lb.in
- Rated insulation voltage Ui:
 - 690VAC for KG types
 - 440VAC for KR types
- Rated impulse withstand voltage Uimp:
 - 6kV for KG types
 - 4kV for KR types
- Class II insulation (KG types only)
- Contact resistance: <10mΩ
- Short-circuit backup protection: 10A gG fuse
- Cable connection: self-releasing screw terminal
- Housing:
 - KG types: self-extinguishing double-insulation polymer thermoplastic
 - KR types: aluminium-zinc alloy
- Cable entry: M20
- Ambient conditions:
 - Operating temperature: -25...+70°C
 - Storage temperature: -40...+70°C
 - Pollution degree: 3
- IEC degree of protection:
 - IP20 for terminals
 - IP54 for body housing
 - IP65 available on request (add the letter S at the end of the order code. E.g. KG100S11S).

Certifications and compliance

Certifications obtained: cURus for contacts only and EAC for foot switches.

Compliant with standards: IEC/EN/BS 60947-1, IEC/EN/BS 60947-5-1, IEC/EN/BS 60204-1, IEC/EN/BS 60447.

General characteristics

The cable glands are in plastic with either M20 or PG13.5 thread and provide to keep the cable in place and maintain the proper IP protection of the switch after installation.

Operational characteristics for cable gland

- Material: self-extinguishing polyamide
- IEC degree of protection: IP68
- Gland seal with cable diameter: 6...12mm/0.24"...0.47".

Certifications and compliance

Certifications obtained: EAC.
Compliant with standards: EN/BS 50262, UL508.

Order code	Description	Qty per pkg	Wt
		n°	[kg]

Accessories.

KGX01	Kit of elements to activate 2° contact block ④	10	0.039
KGX02	Contact block mounting bracket	10	0.022

Cable glands and cable conduit.

KXP01	M20 cable gland	50	0.009
KXP02	PG13.5 cable gland	50	0.009
KXP03	M20 rubber cable conduit	50	0.004

9 Limit, micro and foot switches

Dimensions [mm (in)]

LIMIT SWITCHES K SERIES

**KBA1...
KMA1...**

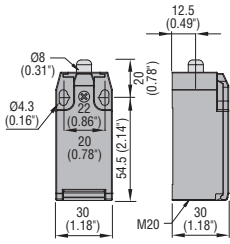

**KCA1
KNA1**

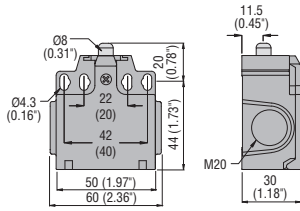

**KBB1... - KBB2...
KMB1... - KMB2...**

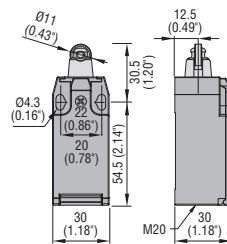

**KCB1... - KCB2...
KNB1... - KNB2...**

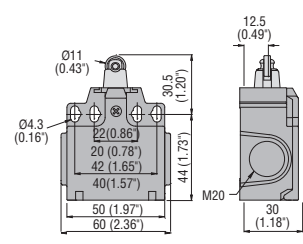

**KBC1... - KBC2...
KMC1... - KMC2...**

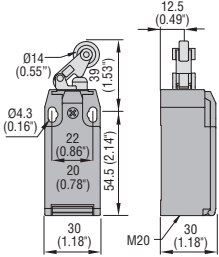

**KCC1... - KCC2...
KNC1... - KNC2...**

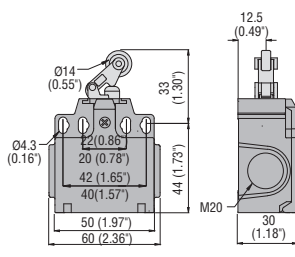

**KBD1... - KBD2...
KMD1... - KMD2...**

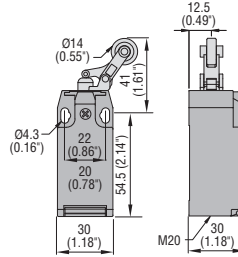

**KCD1... - KCD2...
KND1... - KND2...**

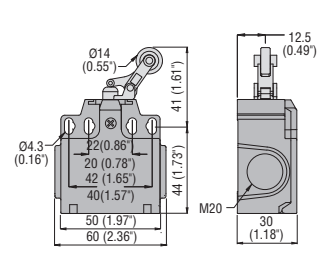

**KBE1... - KBE2...
KME1... - KME2...**

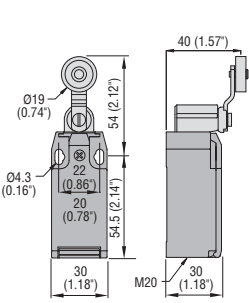

**KCE1... - KCE2...
KNE1... - KNE2...**

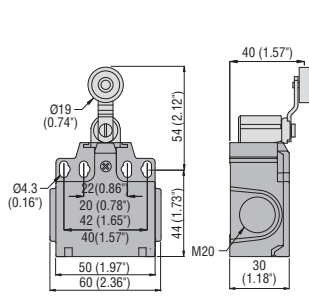

**KBE3...
KME3...**

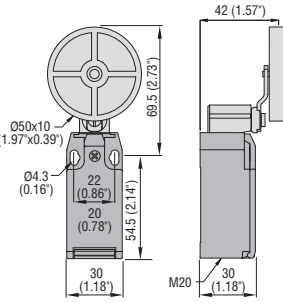

**KCE3...
KNE3...**

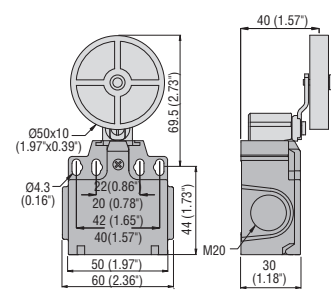

**KBF1... - KBF2...
KMF1... - KMF2...**

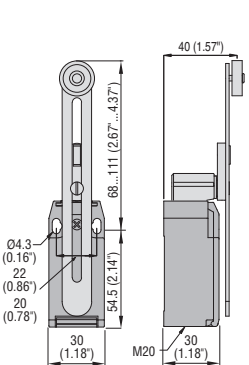

**KCF1... - KCF2...
KNF1... - KNF2...**

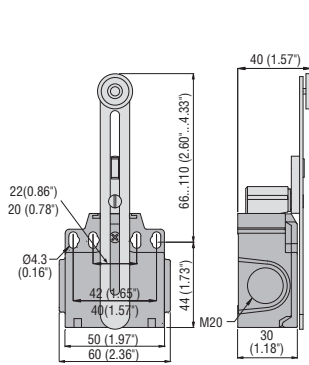

**KBF3...
KMF3...**

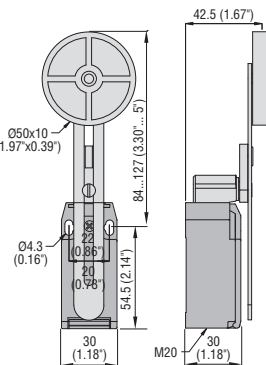

**KCF3...
KNF3...**

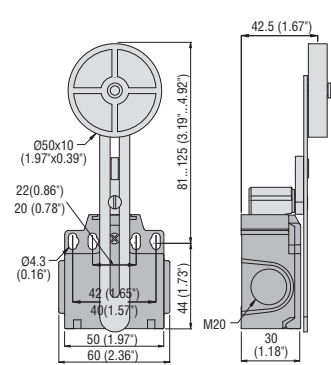

**KBF4...
KMF4...**

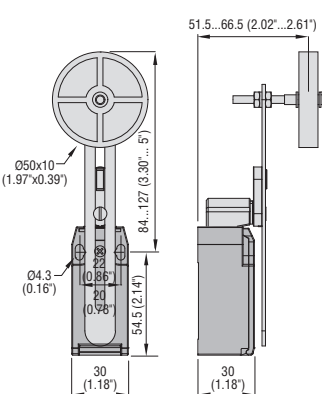

**KCF4...
KNF4...**

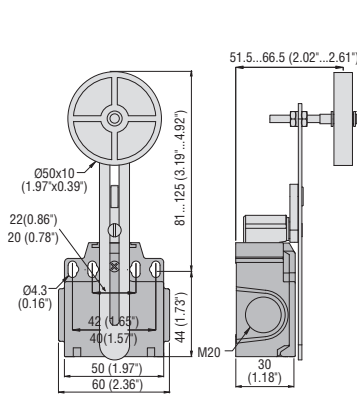

**KBH1...
KMH1...**

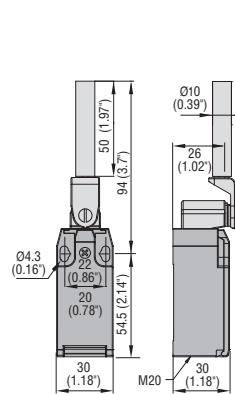

**KCH1...
KNH1...**

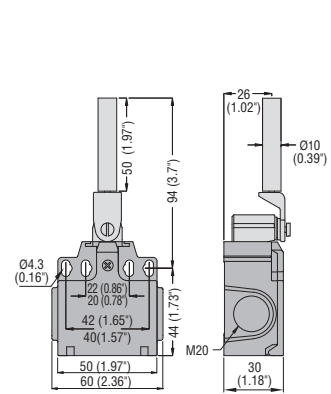

9 Limit, micro and foot switches

Dimensions [mm (in)]

LIMIT SWITCHES K SERIES

KBL1... - KBL2...
KML1... - KML2...

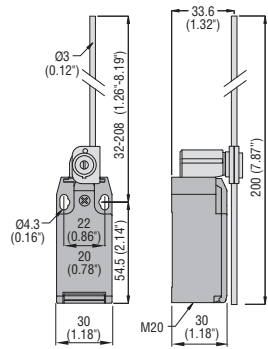

KCL1... - KCL2...
KNL1... - NNL2...

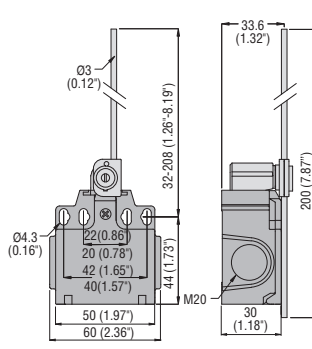

KBM1... - KBM2...
KMM1... - KMM2...

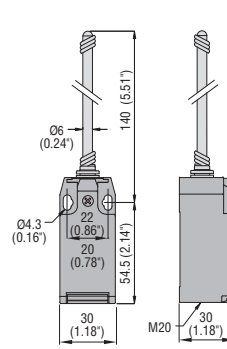

KCM1... - KCM2...
KNM1... - KNM2...

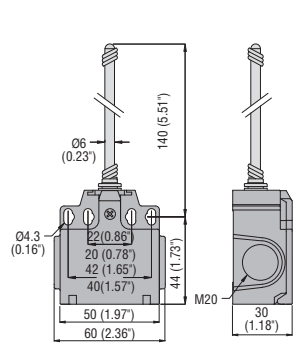

KBP1...
KMP1...

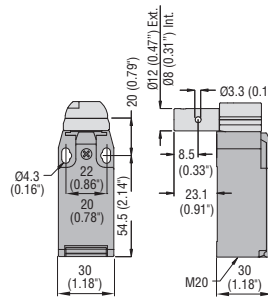

KBP2...
KMP2...

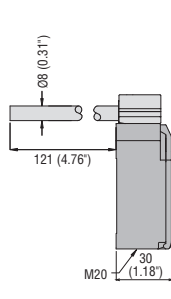

KBP3...
KMP3...

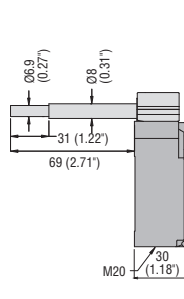

KCP1...
KNP1...

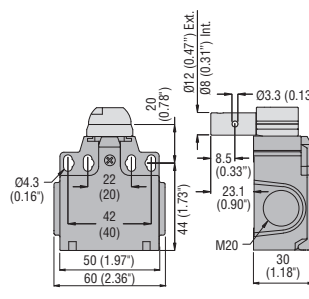

KCP2...
KNP2...

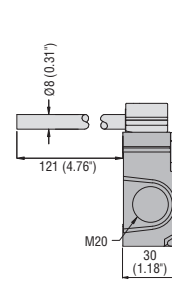

KCP3...
KNP3...

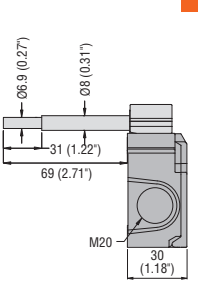

KBQ1L...
KMQ1L...

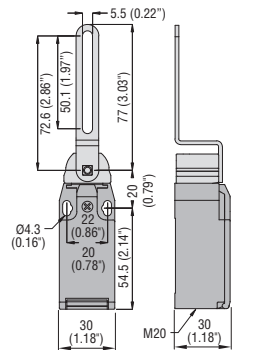

KCQ1L...
KNQ1L...

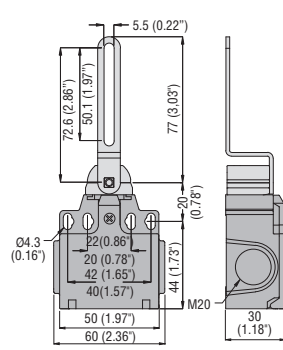

KBN1... - KBN2...
KMN1... - KMN2...

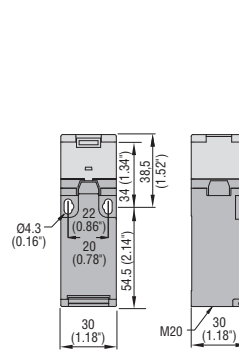

KCN...

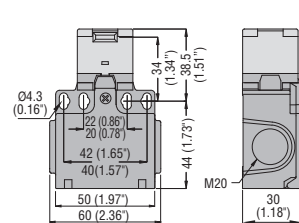

Keys
KXN1

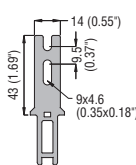

KXN2

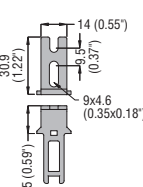

KXN3

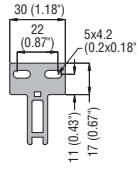

KXN4

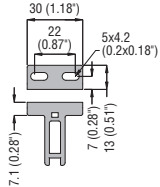

KXN5

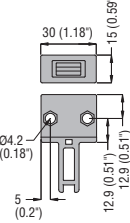

Cable glands

KXP01

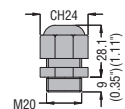

KXP02

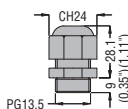

Cable conduit

KXP03

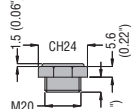

CH = Spanner/Wrench

CH = Spanner/Wrench

CH = Spanner/Wrench

PREWIRED METAL LIMIT SWITCHES

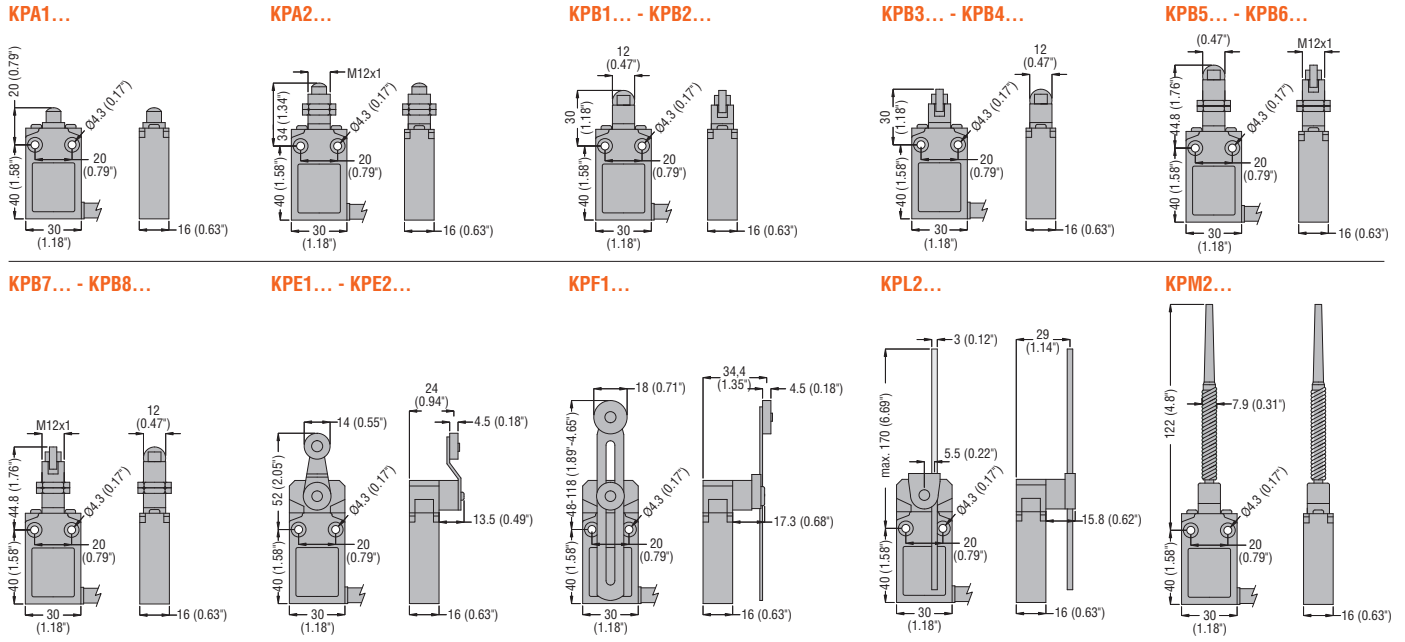

9 Limit, micro and foot switches

Dimensions [mm (in)]

METAL LIMIT SWITCHES, PL SERIES

PLN...A

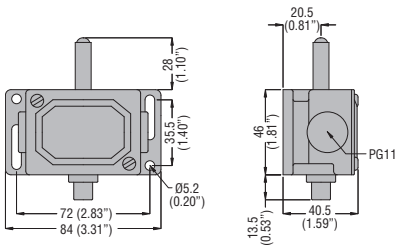

PLN...AW

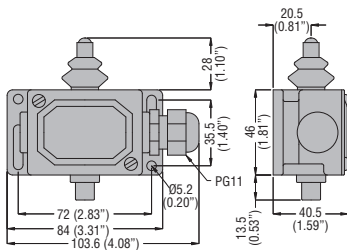

PLN...R

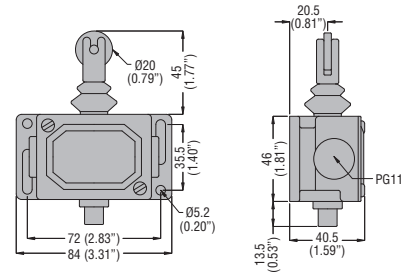

PLN...RW

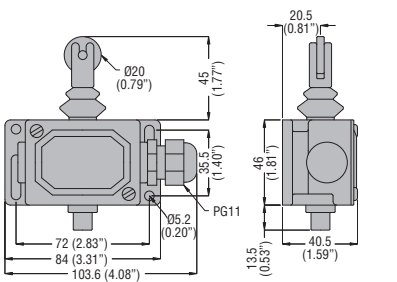

PLN...H

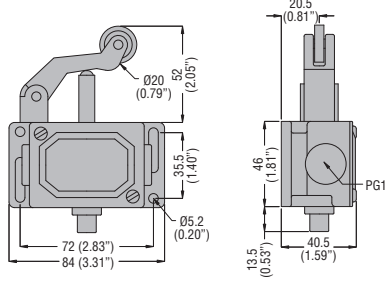

PLN...HW

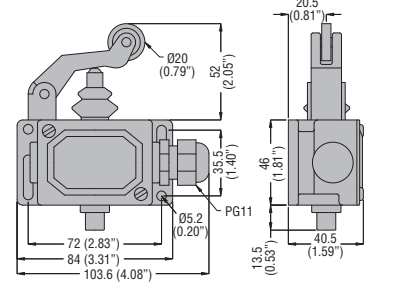

PLN...HSB

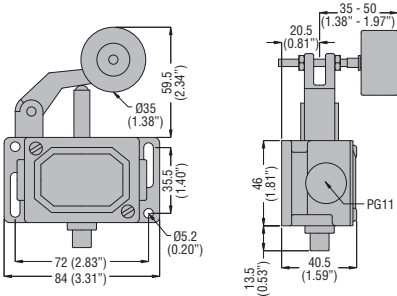

PLN...HSBW

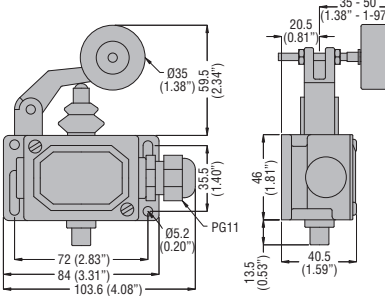

PLNA1RAG

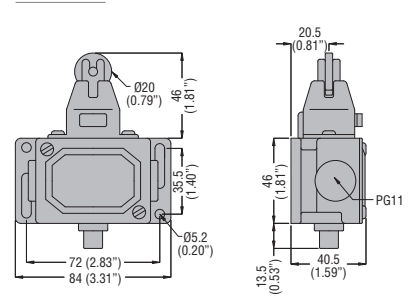

PLNA1RAGW

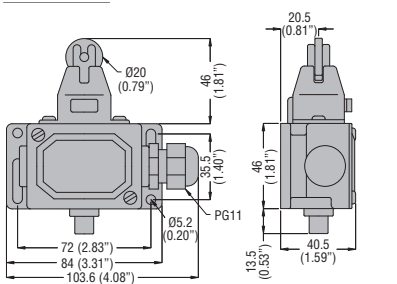

PLNA1AM

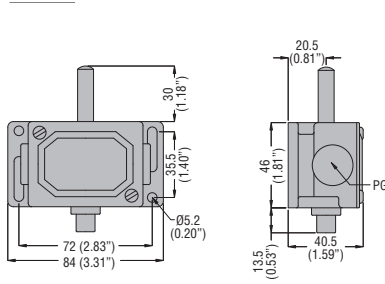

PLA1AMW

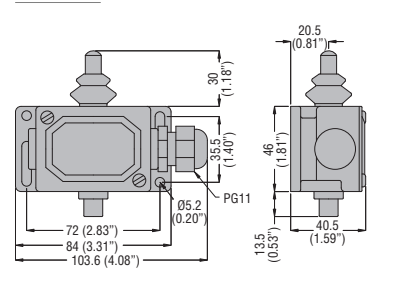

PLA1RM

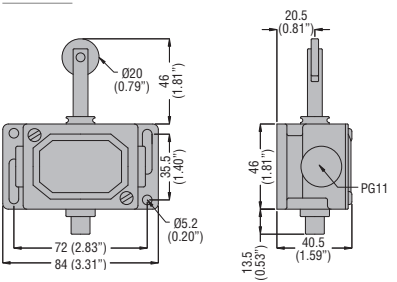

PLA1RMW

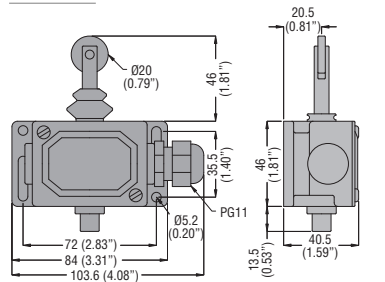

PLN978

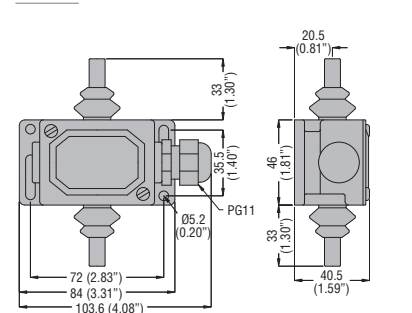

9 Limit, micro and foot switches

Dimensions [mm (in)]

ROPE-PULL LEVER LIMIT SWITCHES FOR NORMAL STOPPING

RS113... - RS313...

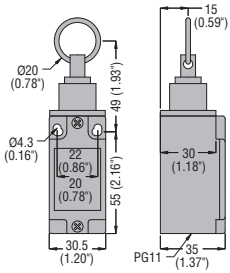

PLN...AT

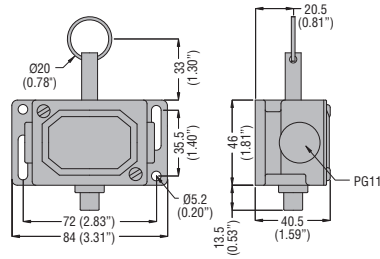

PLN...ATW

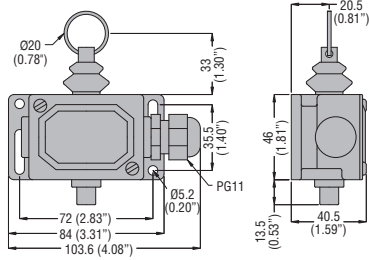

P2L...

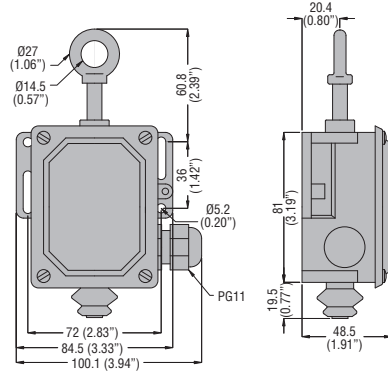

ROPE-PULL SAFETY LIMIT SWITCHES, ISO 13850 COMPLIANT

RS131310

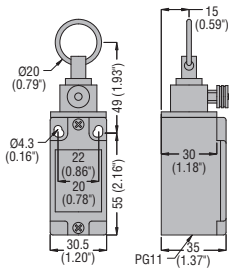

PLN131311

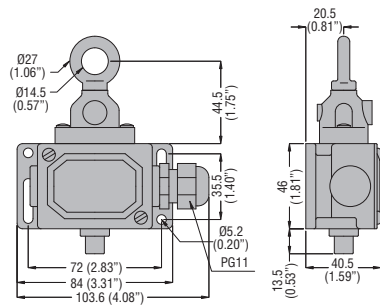

P2L13... - P2L15...

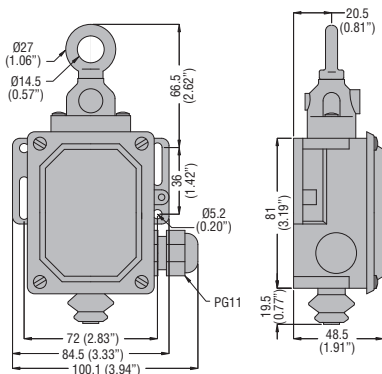

9 Limit, micro and foot switches

Dimensions [mm (in)]

SAFETY SWITCHES WITH SOLENOID

KEN1...

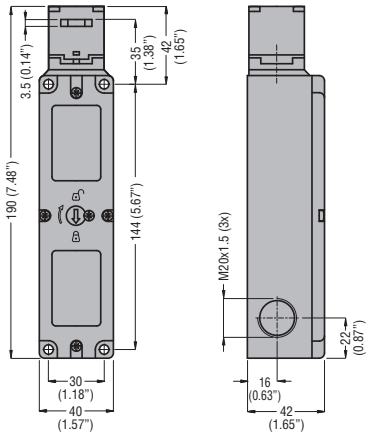

KEXN1

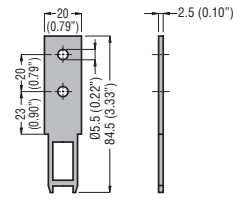

KEXN2

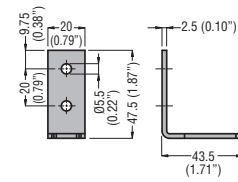

KEXN5

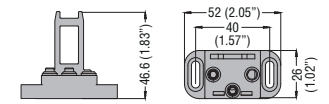

PLASTIC MICRO SWITCHES

KSA1...

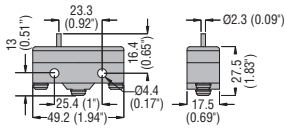

KSA2...

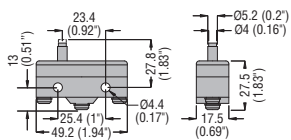

KSA3...

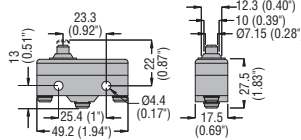

KSA4...

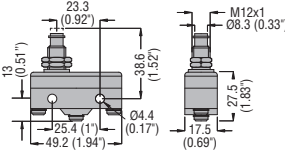

KSA9...

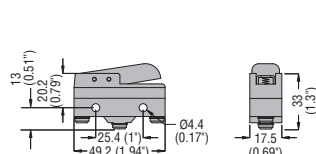

KSB1...

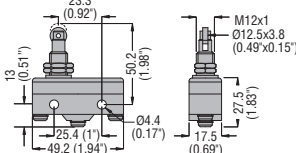

KSB2...

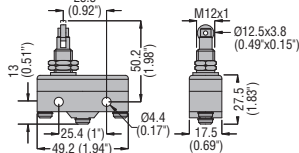

KSC1...

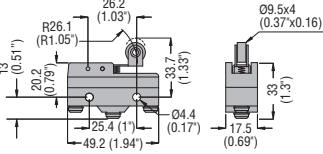

KSC2...

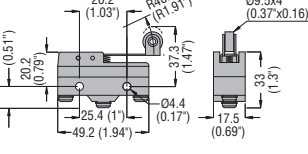

KSC3...

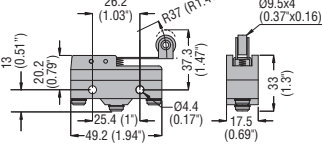

KSC9...

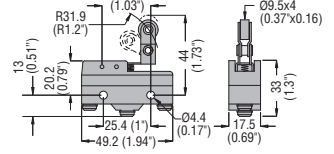

KSL1...

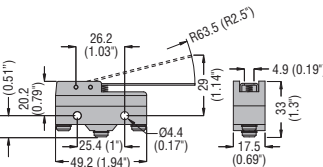

KSL2...

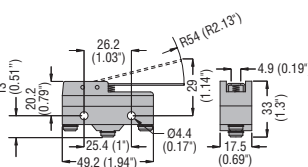

KSL3...

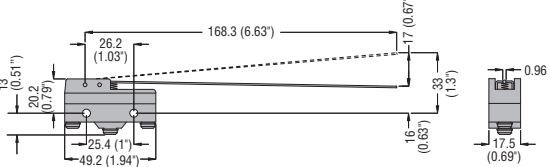

TERMINAL SHROUD

KSSC01

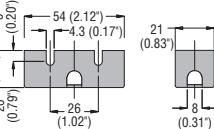

KSSCB2

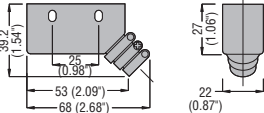

9 Limit, micro and foot switches

Dimensions [mm (in)]

FOOT SWITCHES

KG1

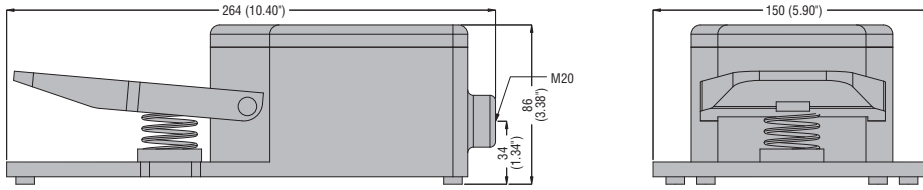

KG2

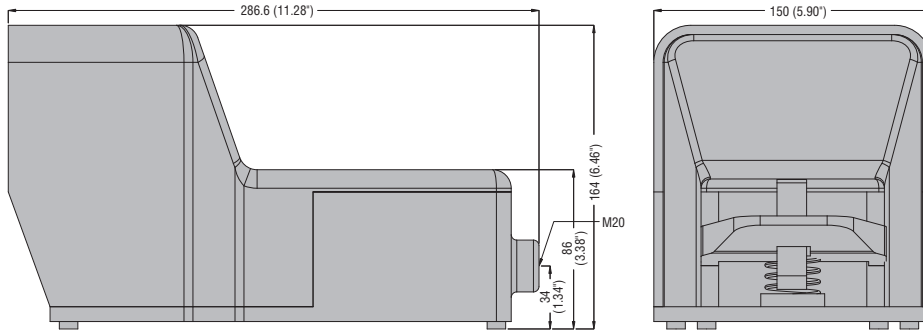

KR1

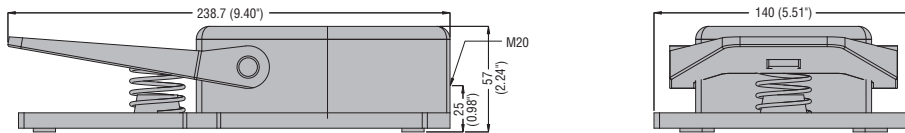

KR2

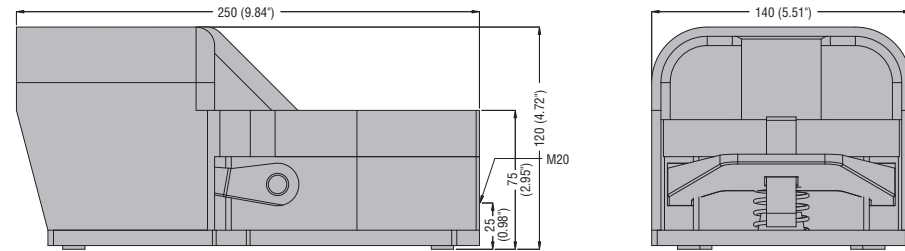

KGD

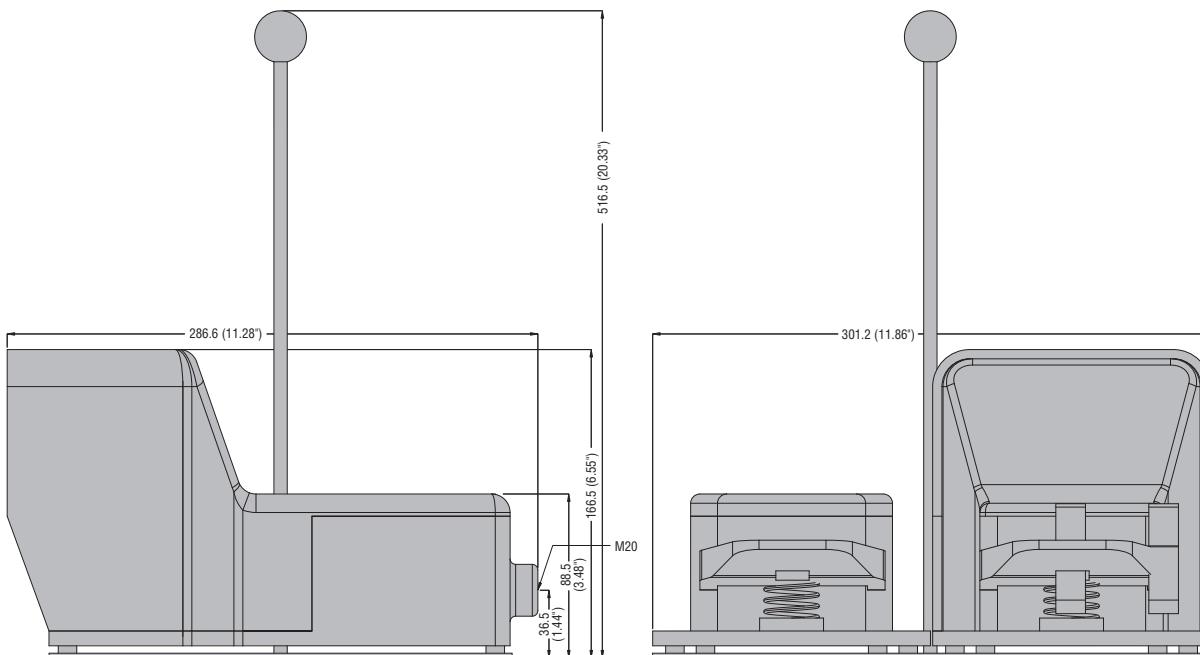

LIMIT SWITCHES, KB - KM - KC - KN TYPES

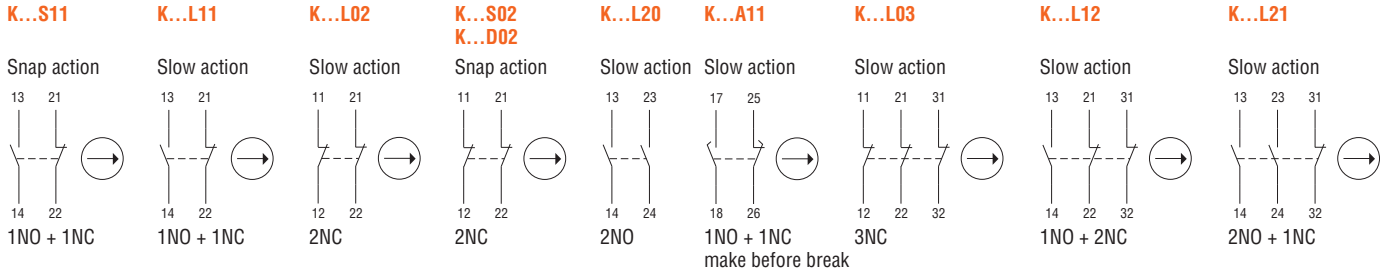

PREWIRED METAL LIMIT SWITCHES

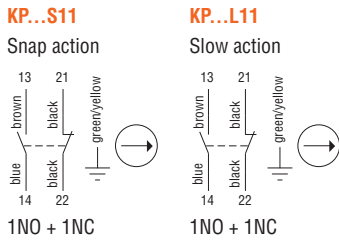

LIMIT SWITCHES, PL TYPE

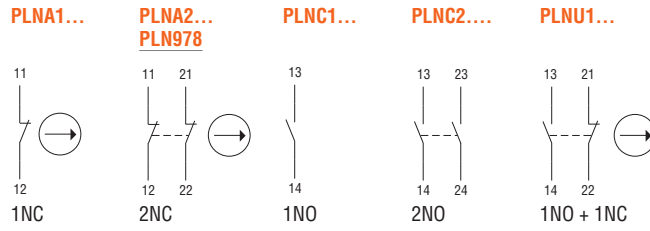

LIMIT SWITCHES FOR NORMAL STOPPING

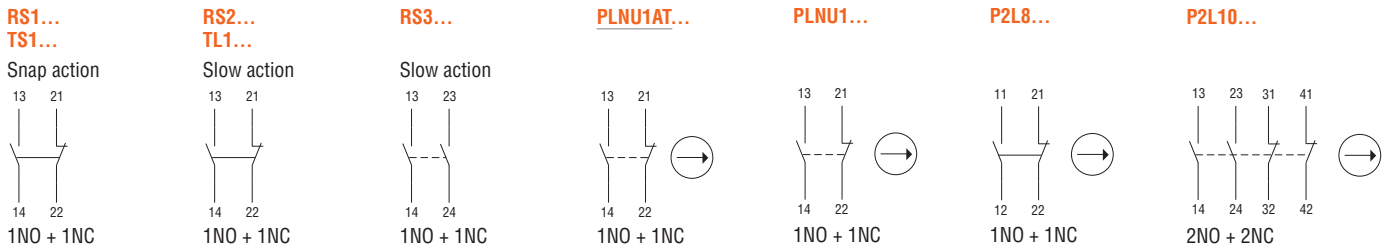

LIMIT SWITCHES FOR EMERGENCY STOPPING

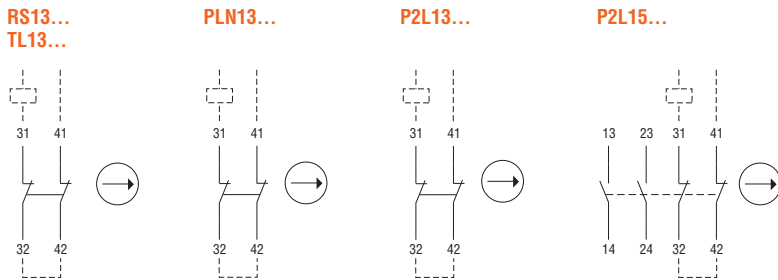

PLASTIC MICRO SWITCHES

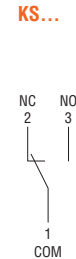

SAFETY SWITCHES WITH SOLENOID

Actuator inserted and unlocked

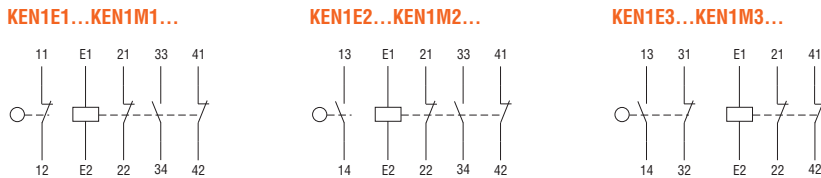

FOOT SWITCHES

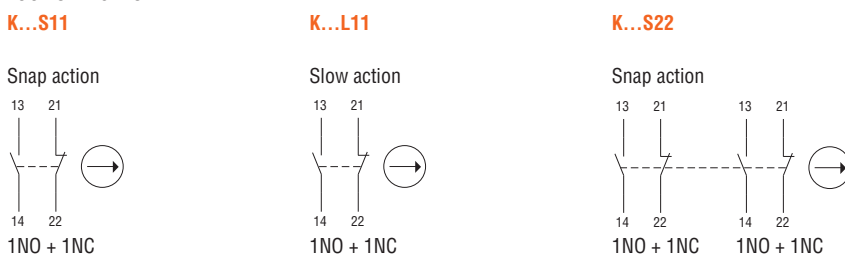



- Safety relays with performance level up to Cat.4, PLe compliant to EN/BS 13849-1
- Multifunction version with frontal trimmer for function selection
- Dedicated versions for emergency stop, light curtains and two-hand control devices
- Expansion module
- Compact design with 35mm DIN rail mounting.

Safety relays

	SEC. - PAGE
Safety relays SRB series.....	10 - 2
Safety relays SRA series.....	10 - 2

Dimensions	10 - 3
------------------	--------

Wiring diagrams	10 - 3
-----------------------	--------

Technical characteristics	10 - 5
---------------------------------	--------



Page 10-2

SRB... SERIES

- 24VAC/DC auxiliary supply
- For safety control of emergency stop, safety switch and magnetic sensors
- Expansion module of safe outputs
- 35mm DIN rail mounting
- 17.8mm width.



Page 10-2

SRA... SERIES

- 24VDC auxiliary supply
- Multifunction version with frontal trimmer for function selection
- For safety control of light curtains, two-hands control devices, laser scanner and RFID
- 35mm DIN rail mounting
- 22.5mm width.

	Emergency stop	Safety switch	Magnetic sensors	Two-hand control devices	Safety devices with OSSD outputs (light curtains, laser scanner, RFID,...)	Mechanical safety interlock	Expansion module of safe outputs
SRBES20	●	●	●			●	
SRBES31	●	●	●			●	
SRBEM41							●
SRATH21				●			
SRALC21					●		
SRASM20					●		
SRAMF21	●	●	●	●	●	●	

SRB... series



SRBES...



SRBEM41

new

Order code	Auxiliary supply voltage	Type of output contact	Function	Qty per pck	Wt
	[V]			n°	[kg]
Single function.					
SRBES20	24V AC/DC	2NO	Emergency stop	1	0.209
SRBES31		3NO+1NC	Emergency stop	1	0.230
Safe outputs expansion module.					
SRBEM41	24V AC/DC	4NO+1NC	Expansion module	1	0.239

General characteristics

LOVATO Electric safety relays are designed for applications up to Category 4 and performance level up to PLe according to EN/ISO/BS 13849-1.

The SRB ... safety relays are designed in order to monitor and control safety circuits in applications with:

- Emergency stops
- Security accesses
- Magnetic safety switches
- Safety limit switches
- Electromechanical interlocks.

They are also used to safely control the circuits for lift cabin leveling and inspection of the lifting pit, according to EN/BS 81-20 and EN/BS 81-50 lift standards.

SRBEM41 is an expansion module to extend the number of safe outputs.

Main characteristics

- Auxiliary supply voltage: 24VAC / DC
- 35mm DIN rail mounting (IEC / EN / BS 60715)
- Compact size: 17.8mm wide
- Double or single channel operation
- Control up to 3 NO safety outputs with electromechanical relay with forced guidance
- Start / reset operating mode (manual, automatic or monitored manual)
- Diagnostics of the safety circuit through indications of LEDs for power supply, safety input status and status of the safety outputs
- The short circuit between the two input channels is detected
- In the event of a fault, the safe outputs are deactivated (contacts opened)
- 1 NC auxiliary output (SRBES31) that can be used for remote status indication
- Removable screw terminal connection
- Front protection degree: IP40
- Terminal protection degree: IP20.

Certifications and compliance

Certifications obtained: cULus, TUV.

Compliant with standards: Cat. 4, PLe according to EN/BS 13849-1, EN/BS 81-20, EN/BS 81-50 (SRBES20 and SRBES31 only).

SRA... series



SRAMF21

new

Order code	Auxiliary supply voltage	Type of output contact	Function	Qty per pck	Wt
	[V]			n°	[kg]
Single function.					
SRATH21	24VDC	2NO+1PNP	Two-hand control devices	1	0.150
SRALC21	24VDC	2NO+1PNP	Devices OSSD	1	0.150
SRASM20	24VDC	2NA	Devices OSSD	1	0.150
Multifunction.					
SRAMF21	24VDC	2NO+1PNP	Multi-function	1	0.150

General characteristics

The LOVATO Electric SRA... safety relays are designed in order to monitor and control safety circuits in applications with:

- SRATH21: monitoring of two-hand control devices
- SRALC21: monitoring of safety devices equipped with OSSD (light curtains, laser scanner, RFID)
- SRASM20: monitoring of devices equipped with OSSD and integrated safety functions.

The SRAMF21 multifunction safety relay offers the possibility of having all the safety functions of SRB series and the three SRA codes above in one device. This is achieved by simply selecting the desired function using the dedicated frontal trimmer.

The SRAMF21 multifunction safety relay monitors and controls safety circuits in applications with:

- Emergency stops
- Security accesses
- Magnetic safety switches
- Safety limit switches
- Electromechanical interlocks
- Input from OSSD (for ESPE and RFID), automatic restart or monitored manual restart
- Command of two-hand control devices
- Control for type 2 photocells, manual or automatic restart.

Main characteristics

- Auxiliary supply voltage: 24VDC
- 35mm DIN rail mounting (IEC / EN / BS 60715)
- 1 PNP output for system monitoring
- 1 feedback input from external contactors
- 1 test input (for light curtains)
- Alarm diagnostics through LED flashing
- Front protection degree: IP20
- Terminal protection degree: IP20.

Certifications and compliance

Certifications (pending): cULus, TUV.

Compliant with standards: Cat. 4, PLe according to EN/BS 13849-1.

10 Safety Relays

Dimensions [mm (in)]
Wiring diagrams

SRBES20 - SRBES31 - SRBEM41

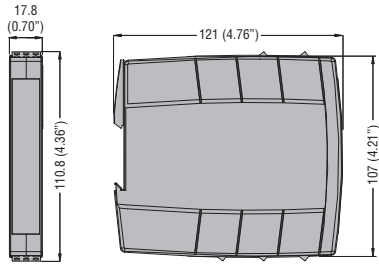

SRATH21 - SRALC21 - SRASM20 - SRAMF21

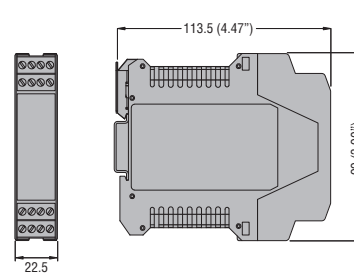

Wiring diagrams

SRBES20

Double channel mode, manual start

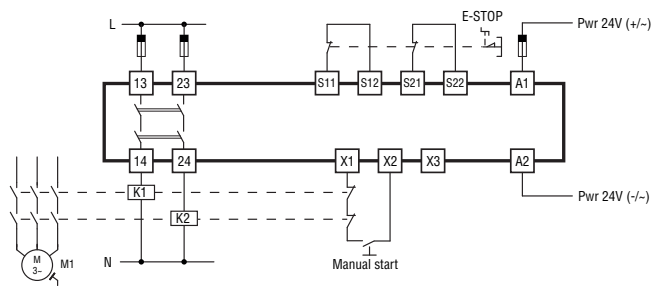

SRBES20

Single channel mode, manual start

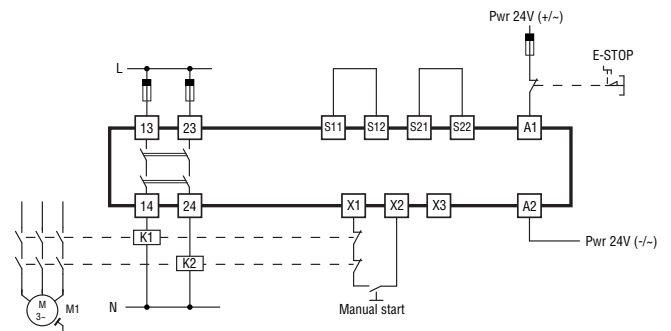

SRBES31

Double channel mode, manual start

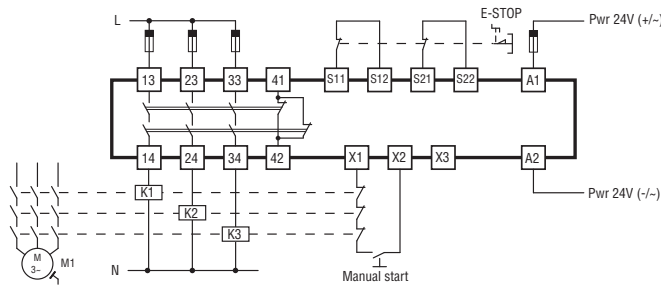

SRBES31

Single channel mode, manual start

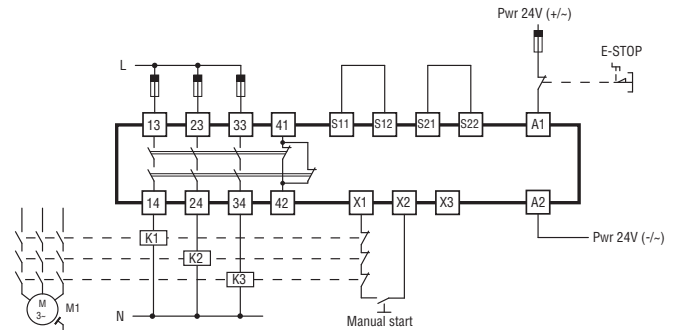

SRBEM41

Double channel mode

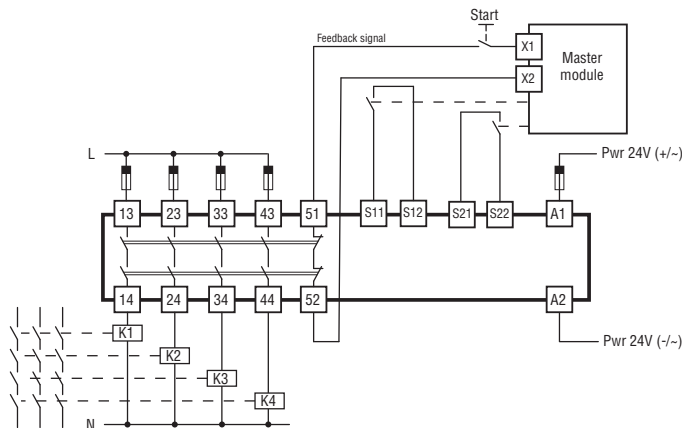

SRBEM41

Single channel mode

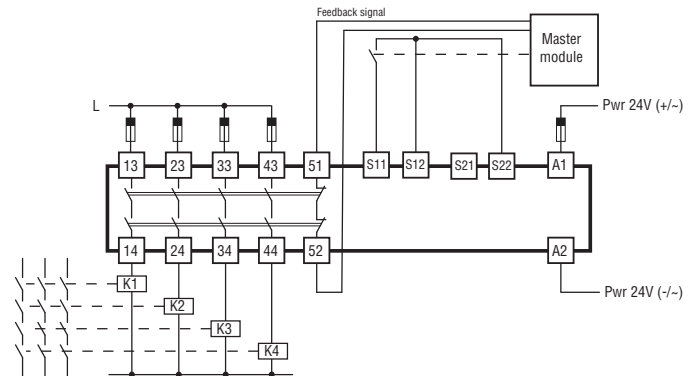

SRAMF21

1A, 1C mode: OSSD inputs

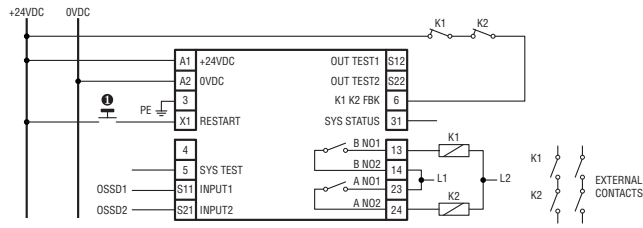

2A, 2M, 2C mode: security accesses and emergency stops.

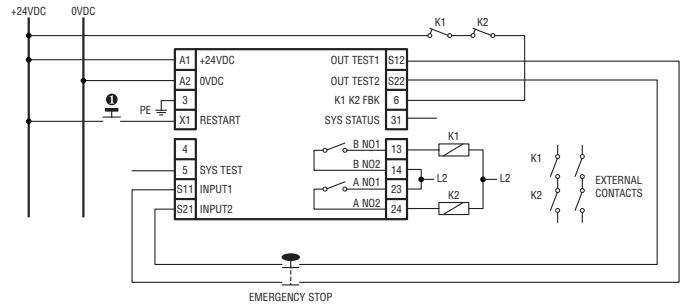
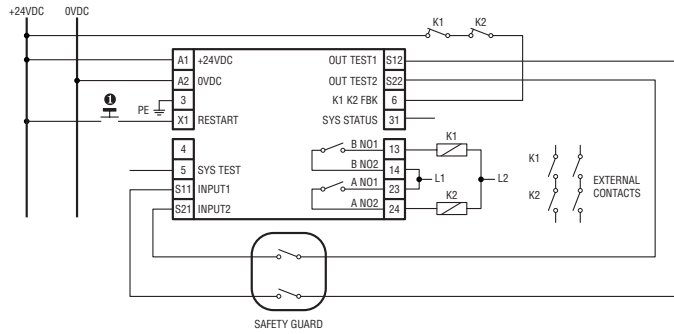

Mode 3A: two-hand control devices

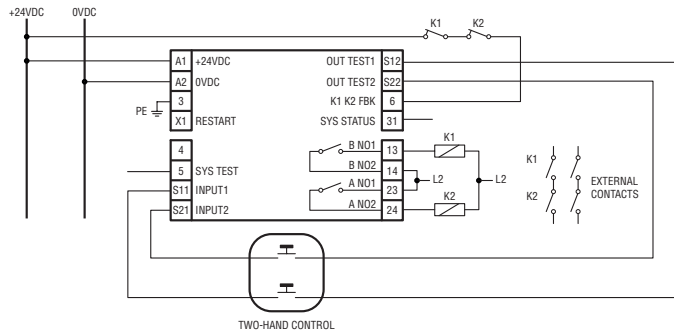

Mode 3C: two-hand control devices, changeover contacts

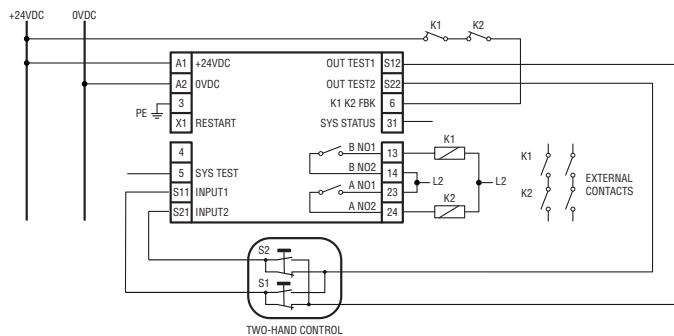

Mode 4A, 4C: light curtains

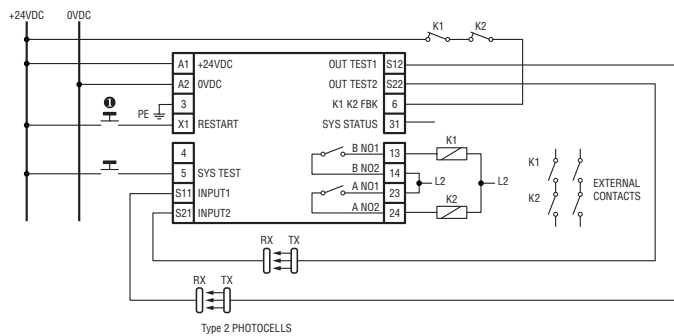

ⓘ Not necessary when used in automatic mode.

10 Safety Relays

Technical characteristics

Type	SRBES20	SRBES31	SRBEM41	SRATH21	SRALC21	SRASM20	SRAMF21
AUXILIARY SUPPLY							
Nominal auxiliary voltage supply	24VAC/DC			24VDC			
Operating range	22...26VDC, 20.4...27.6VAC			19...29VDC			
Frequency range	50-60Hz			-			
Overvoltage category	III						
Insulation voltage	4kV						
Protection	Short circuit with PTC			Signaling output protected from overload		-	Signaling output protected from overload
INPUTS							
Number	2						
Resistance input circuit	Max 1k Ω			-			
Input current	Typical 5mA			Typical 4.3mA			
Input voltage	-	0-35VDC		0-30VDC			
OUTPUTS							
Number of safe outputs NO	2	3	4	2	2	2	2
Number of safe outputs NC	-	1	-	-	-	-	-
Number of feedback outputs	-	-	1NC	1PNP	1PNP	-	1PNP
Type	Voltage free contacts, relays with forced guided contacts			Relays with forced guided contacts			
Ratings	AC1 250V: 6A - 2000VA AC15 230V: 3A - DC1 24V: 6A DC13 24V: 2.5A			AC1 250V: 6A - 2000VA AC15 230V: 5A DC13 24V: 2A			
UL 508 ratings	Pilot duty: B300 - R300			Pilot duty: B300 - Q300			
Mechanical life	>10 ⁷ operations						
Electrical life AC1 at 360 commutations/h	10 ⁵ operations						
SAFETY PARAMETERS							
ISO 13849-1 security category	Cat. 4						
ISO 13849-1 performance level	PLe						
AMBIENT CONDITIONS							
Degree of protection	IP40 on front, IP20 on terminals			IP40 on front, IP20 on terminals			
Degree of pollution	2						
Operating temperature	-25...+60°C			-25...+55°C			
Storage temperature	-30...+70°C						
Relative humidity	R.H. \leq 95%						
CERTIFICATIONS AND COMPLIANCE							
Certifications	cULus, TUV						
Compliance	Cat. 4, PLe according to EN/BS 13849-1, EN/BS 81-20, EN/BS 81-50		Cat. 4, PLe according to EN/BS 13849-1	Type 4 according to EN/BS 61496 Cat. 4, PLe according to EN/BS ISO 13849-1		-	Type 4 according to EN/BS 61496 Cat. 4, PLe according to EN/BS ISO 13849-1



- Suitable for circuit connection, changeover, switching ON and OFF as well as motor starting
- Possible special circuit schemes
- IEC IP40 or IP65 front degree of protection
- Door mount, rear mount or in enclosure versions
- Wide range of features.

	SEC.	-	PAGE
Order code structure	11	-	2
Special circuit scheme form	11	-	3
Switching			
ON/OFF switches, front mounting, U version	11	-	4
ON/OFF switches, rear mounting, O version	11	-	7
ON/OFF switches in enclosure, P/L version	11	-	9
Changeover switches with or without 0, front mounting, U version	11	-	10
Changeover switches with or without 0, rear mounting, O version	11	-	12
Changeover switches with or without 0, in enclosure, P/L version	11	-	13
Multi-step			
Starting with 1, front mounting, U version	11	-	14
Starting with 1, rear mounting, O version	11	-	16
Starting with 1 in enclosure, P/L version	11	-	17
Starting with 0, front mounting, U version	11	-	18
Starting with 0, rear mounting, O version	11	-	20
Starting with 0, in enclosure, P/L version	11	-	21
Measuring			
Voltmeter and ammeter switches, front mounting, U version	11	-	22
Voltmeter and ammeter switches, rear mounting, O version	11	-	24
Motor starting			
Motor reversing, star-delta, Dahlander motor control, separate winding switches, front mounting, U version	11	-	26
Motor reversing, star-delta, Dahlander motor control, separate winding switches, rear mounting, O version	11	-	30
Motor reversing, star-delta, Dahlander motor control, separate winding switches, in enclosure, P/L version	11	-	34
Versions and dimensions	11	-	36
Accessories	11	-	43
Technical characteristics	11	-	44



GF SERIES

- IEC conventional free air thermal current Ith 10A and 20A
- Up to 24 contacts
- Direct (positive) opening action \ominus ; according to IEC/EN/BS 60947-5-1
- Up to 12 switching positions
- Rotation angles: 30°, 45°, 60°, 90°
- Possibility of side-by-side installation
- IEC IP20 degree of protection of contacts
- IEC IP40 degree of protection of front, standard supplied.



7GN SERIES

- IEC conventional free air thermal current Ith 16...125A
- Round-shaped contact body
- Up to 24 contacts
- Direct (positive) opening action \ominus ; according to IEC/EN/BS 60947-5-1
- Up to 12 switching positions
- Rotation angles: 30°, 45°, 60°, 90°
- Available versions in plastic enclosure
- IEC IP40 degree of protection of front, standard supplied.



GX SERIES

- IEC conventional free air thermal current Ith 16...40A
- Square-shaped contact body
- Up to 24 contacts
- Direct (positive) opening action \ominus ; according to IEC/EN/BS 60947-5-1
- Up to 12 switching positions
- Rotation angles: 30°, 45°, 60°, 90°
- Available versions in plastic enclosure
- Possibility of side-by-side installation
- IEC IP20 degree of protection of contacts
- IEC IP65 degree of protection of front, standard supplied.



GN SERIES

- IEC conventional free air thermal current Ith 200...315A
- Available on request versions up to 2000A
- Up to 24 contacts
- Direct (positive) opening action \ominus ; according to IEC/EN/BS 60947-5-1
- Up to 12 switching positions
- Rotation angles: 30°, 45°, 60°, 90°
- Available versions in metal enclosure
- 200A to 315A versions cURus approved.



Page 11-42

GNA20 SERIES

- IEC conventional free air thermal current Ith 20A
- Up to 48 contacts
- Direct (positive) opening action \ominus ; according to IEC/EN/BS 60947-5-1
- 4 contacts for each element
- Reduced depth
- Rotation angles: 30°, 45°, 60°, 90°
- Available versions in plastic enclosure
- IEC IP20 degree of protection of contacts.

11 Rotary cam switches

Order code structure

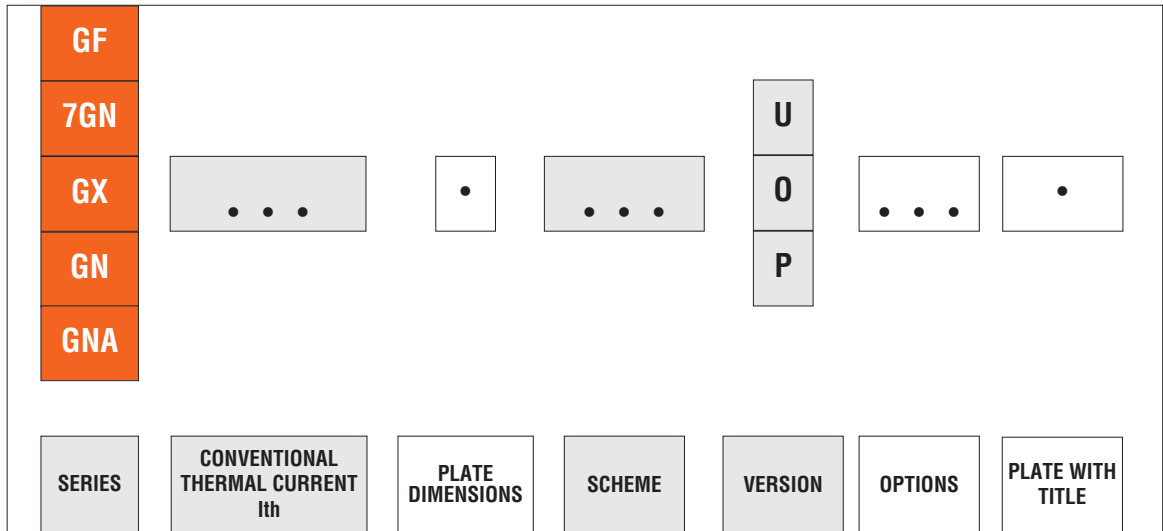

- GF**
IEC protection:
Front = IP40
Contacts = IP20
- 7GN**
IEC protection:
Front = IP40
Contacts = IP00
- GX**
IEC protection:
Front = IP65
Contacts = IP20
- GN**
IEC protection:
Front = IP40
Contacts = IP00
- GNA**
IEC protection:
Front = IP40
Contacts = IP20

GF	7GN	GX	GN	GNA
10A	16A	16A	200A	20A
20A	20A	20A	315A	
	25A	32A	32A	
	40A	40A		
	63A			
	125A			

- 90
 - 91
 - 10
 - 92
 - 99
 - 100
 -
 - ❶
- U** = Front mount
O = Rear mount
P = In plastic enclosure
L = In metal enclosure (only for GN series)

N = Add N for version with front plate with title and neutral label

Insert H when an enlarged front plate is required

Standard plate	Enlarged plate
GF10 = 30x30mm GF20 = 48x48mm	GF10H = 48x48mm GF20H = 65x65mm
7GN12...25 = 48x48mm 7GN32...63 = 65x65mm	7GN12H...25H = 65x65mm 7GN32H...63H = 90x90mm
GX16...20 = 48x48mm GX32...40 = 65x65mm	GX16H...20H = 65x65mm GX32H...40H = 90x90mm
GNA20 = 65x65mm	GNA20H = 90x90mm

25	Front mounting with red/yellow handle padlockable in 0 and protection covers
65	Front mounting with red/yellow handle padlockable in 0 and protection covers (7GN only)
11	Front mounting with black handle without front plate for hole Ø22mm fixing
12	Front mounting without front plate with key operation for hole Ø22mm fixing
47	Snap on front mounting with black handle for hole Ø22mm fixing
48	Modular service cover for 35mm DIN rail mounting with black handle
88	Rear mounting with red/yellow handle padlockable in 0, door coupling and protection covers
98	Rear mounting with red/yellow handle padlockable in 0, door coupling and protection covers (7GN only)
4V	Front mounting with 4 screws fixing
51	Front mounting with black handle with IP65 front protection
24	Front mounting with red/yellow handle not padlockable in 0 and without protection covers
29	Front mounting with front plate with key operation for hole Ø22mm fixing
29D	Snap on front mounting with key operation for hole Ø22mm fixing
06	Front mounting with black handle padlockable in 0
49	Modular service cover for 35mm DIN rail mounting with key operation

Example for ordering:

- GX1653P** = Changeover switch, 16A, 3 poles, 3 positions, 3 wafers in 90x90mm IEC IP65 enclosure.
- 7GN25H90U51** = ON-OFF switch, 25A, 1 pole, 2 positions, 1 wafer with enlarged 65x65mm front plate and IEC IP65 protection.

Consult Technical support for informations; see contact details on inside front cover.

❶ Special schemes are available on request; complete the form on page 11-3.



Consult manual I230 on the website www.LovatoElectric.com for further information (configuration of contacts, diagrams, plate indications, etc.).

11 Rotary cam switches

Special circuit scheme form

1	4	5	8	9	12	13	16	17	20	21	24	25	28	29	32	33	36	37	40	41	44	45	48
2	3	6	7	10	11	14	15	18	19	22	23	26	27	30	31	34	35	38	39	42	43	46	47

Plate indication	Pos.																								
	7																								
C	8																								
	9																								
	10																								
D	11																								
	12																								
	1																								
A	2																								
	3																								
	4																								
	5																								
B	6																								

Front plate

1	X		X		X																				
2	X		X		X																				X
	Overlapping contacts		Close contact in 2 or more positions		Open/passing contact		Closed contact		Spring return																
SERIES:												<input type="checkbox"/> GF <input type="checkbox"/> 7GN <input type="checkbox"/> GX <input type="checkbox"/> GN <input type="checkbox"/> GNA												Current rating	
VERSION:												<input type="checkbox"/> Front mount <input type="checkbox"/> Rear mount <input type="checkbox"/> Enclosed <input type="checkbox"/> Other												
FINISH:												<input type="checkbox"/> Standard ^❶ <input type="checkbox"/> Red/yellow padlockable <input type="checkbox"/> Special												
FIXING:												<input type="checkbox"/> 2 screws <input type="checkbox"/> 4 screws <input type="checkbox"/> Snap													
Qty:.....												Company name:													
												Contact details:													

^❶ Standard supplied finish is black front plate while 0-12 indication and the handle are black; any other is considered special.
 Also consult technical instruction I230 on the website www.LovatoElectric.com.

ON/OFF SWITCHES



Front mounting with black handle (U)①

WIRING DIAGRAMS				②90	②91	②10	②92	③05	③06	③07	③08	③03
Poles				1	2	3	4	1	2	3	4	3
Series	Front plate size [mm]	Rated thermal current I _{th} [A]	UL/CSA general use [A]									
GF...	□30	10	10	GF1090U	GF1091U	GF1010U	GF1092U	GF1005U	GF1006U	GF1007U	GF1008U	GF1003U
	□48	20	15	GF2090U	GF2091U	GF2010U	GF2092U	GF2005U	GF2006U	GF2007U	GF2008U	GF2003U
7GN...	□48	16	15	7GN1290U	7GN1291U	7GN1210U	7GN1292U	7GN1205U	7GN1206U	7GN1207U	7GN1208U	7GN1203U
		20	20	7GN2090U	7GN2091U	7GN2010U	7GN2092U	7GN2005U	7GN2006U	7GN2007U	7GN2008U	7GN2003U
		25	30	7GN2590U	7GN2591U	7GN2510U	7GN2592U	7GN2505U	7GN2506U	7GN2507U	7GN2508U	7GN2503U
	□65	32	40	7GN3290U	7GN3291U	7GN3210U	7GN3292U	7GN3205U	7GN3206U	7GN3207U	7GN3208U	7GN3203U
		40	50	7GN4090U	7GN4091U	7GN4010U	7GN4092U	7GN4005U	7GN4006U	7GN4007U	7GN4008U	7GN4003U
		63	60	—	—	7GN6310U	7GN6392U	—	—	7GN6307U	7GN6308U	7GN6303U
□90	125	130	—	—	7GN12510U	7GN12592U	—	—	7GN12507U	7GN12508U	7GN12503U	
GX...	□48	16	12	GX1690U	GX1691U	GX1610U	GX1692U	GX1605U	GX1606U	GX1607U	GX1608U	GX1603U
		20	15	GX2090U	GX2091U	GX2010U	GX2092U	GX2005U	GX2006U	GX2007U	GX2008U	GX2003U
	□65	32	32	GX3290U	GX3291U	GX3210U	GX3292U	GX3205U	GX3206U	GX3207U	GX3208U	GX3203U
		40	40	GX4090U	GX4091U	GX4010U	GX4092U	GX4005U	GX4006U	GX4007U	GX4008U	GX4003U
GN...	□132	200	200	—	—	GN20010U	GN20092U	—	—	GN20007U	GN20008U	GN20003U
		315	255	—	—	GN31510U	GN31592U	—	—	GN31507U	GN31508U	GN31503U

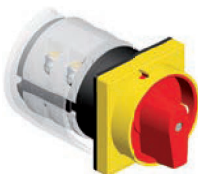

Front mounting with red/yellow handle padlockable in 0 and protection covers (U25)④

WIRING DIAGRAMS				②90	②91	②10	②92	③05	③06	③07	③08
Poles				1	2	3	4	1	2	3	4
Series	Front plate size [mm]	Rated thermal current I _{th} [A]	UL/CSA general use [A]								
GF...	□48	20	15	GF2090U25	GF2091U25	GF2010U25	GF2092U25	GF2005U25	GF2006U25	GF2007U25	GF2008U25
7GN...	□65	16	15	7GN1290U25	7GN1291U25	7GN1210U25	7GN1292U25	7GN1205U25	7GN1206U25	7GN1207U25	7GN1208U25
		20	20	7GN2090U25	7GN2091U25	7GN2010U25	7GN2092U25	7GN2005U25	7GN2006U25	7GN2007U25	7GN2008U25
		25	30	7GN2590U25	7GN2591U25	7GN2510U25	7GN2592U25	7GN2505U25	7GN2506U25	7GN2507U25	7GN2508U25
		32	40	7GN3290U25	7GN3291U25	7GN3210U25	7GN3292U25	7GN3205U25	7GN3206U25	7GN3207U25	7GN3208U25
GX...	□48	16	12	GX1690U25	GX1691U25	GX1610U25	GX1692U25	GX1605U25	GX1606U25	GX1607U25	GX1608U25
		20	15	GX2090U25	GX2091U25	GX2010U25	GX2092U25	GX2005U25	GX2006U25	GX2007U25	GX2008U25
GX...	□65	32	32	GX3290U25	GX3291U25	GX3210U25	GX3292U25	GX3205U25	GX3206U25	GX3207U25	GX3208U25
		40	40	GX4090U25	GX4091U25	GX4010U25	GX4092U25	GX4005U25	GX4006U25	GX4007U25	GX4008U25

- ① For version with black handle padlockable in 0 without protection cover add 06 (e.g. GF1090U06).
- ② Standard version provided with 0-1 front plate. For version with 0-1 front plate add C (e.g. GF20C90U). For version with OFF-ON front plate add D (e.g. GF20D90U).
- ③ For version with OFF-ON front plate add C (e.g. GF20C05U).
- ④ For version with red/yellow not padlockable handle without protection covers replace U25 with U24 (e.g. GF2090U24).

WIRING DIAGRAMS

90-91-10-92

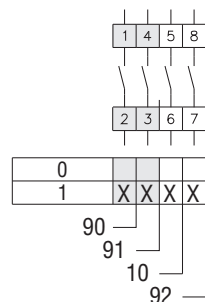

05-06-07-08

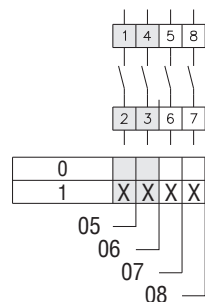

03

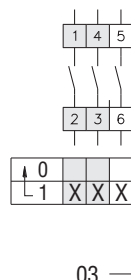

ON/OFF SWITCHES

Front mounting with red/yellow handle padlockable in 0 and protection covers (U65)



WIRING DIAGRAMS				190	191	110	192	205	206	207	208
Poles				1	2	3	4	1	2	3	4
Series	Front plate size	Rated thermal current I _{th}	UL/CSA general use								
	[mm]	[A]	[A]								
7GN...	□65	16	15	7GN1290U65	7GN1291U65	7GN1210U65	7GN1292U65	7GN1205U65	7GN1206U65	7GN1207U65	7GN1208U65
		20	20	7GN2090U65	7GN2091U65	7GN2010U65	7GN2092U65	7GN2005U65	7GN2006U65	7GN2007U65	7GN2008U65
		25	30	7GN2590U65	7GN2591U65	7GN2510U65	7GN2592U65	7GN2505U65	7GN2506U65	7GN2507U65	7GN2508U65
		32	40	7GN3290U65	7GN3291U65	7GN3210U65	7GN3292U65	7GN3205U65	7GN3206U65	7GN3207U65	7GN3208U65
		40	50	7GN4090U65	7GN4091U65	7GN4010U65	7GN4092U65	7GN4005U65	7GN4006U65	7GN4007U65	7GN4008U65
	63	60	—	—	7GN6310U65	7GN6392U65	—	—	7GN6307U65	7GN6308U65	
	□90	125	130	—	—	7GN12510U65	7GN12592U65	—	—	7GN12507U65	7GN12508U65

Front mounting with black handle without front plate for hole Ø22mm fixing (U11)



WIRING DIAGRAMS				90	91	10	92	05	06	07	08	03
Poles				1	2	3	4	1	2	3	4	3
Series	Front plate size	Rated thermal current I _{th}	UL/CSA general use									
	[mm]	[A]	[A]									
GF...	—	20	15	GF2090U11	GF2091U11	GF2010U11	GF2092U11	GF2005U11	GF2006U11	GF2007U11	GF2008U11	GF2003U11
7GN...	—	16	15	7GN1290U11	7GN1291U11	7GN1210U11	7GN1292U11	7GN1205U11	7GN1206U11	7GN1207U11	7GN1208U11	7GN1203U11
		20	20	7GN2090U11	7GN2091U11	7GN2010U11	7GN2092U11	7GN2005U11	7GN2006U11	7GN2007U11	7GN2008U11	7GN2003U11
		25	30	7GN2590U11	7GN2591U11	7GN2510U11	7GN2592U11	7GN2505U11	7GN2506U11	7GN2507U11	7GN2508U11	7GN2503U11
GX...	—	16	12	GX1690U11	GX1691U11	GX1610U11	GX1692U11	GX1605U11	GX1606U11	GX1607U11	GX1608U11	GX1603U11
		20	15	GX2090U11	GX2091U11	GX2010U11	GX2092U11	GX2005U11	GX2006U11	GX2007U11	GX2008U11	GX2003U11

- Standard version provided with 0-1 front plate. For version with 0-1 front plate add C (e.g. 7GN12C90U65). For version with OFF-ON front plate add D (e.g. 7GN12D90U65).
- For version with OFF-ON front plate add C (e.g. 7GN12C05U65).

Technical characteristics

Series	Rated thermal current I _{th}	UL/CSA general use	UL/CSA horsepower ratings					Max. IEC AC23 power 1 phase	Max. IEC AC23 power 3 phases
			1 phase		3 phases				
			120V [HP]	240V [HP]	240V [HP]	480V [HP]	600V [HP]		
GF10...	10	10	—	0.75	2	—	—	0.75	3
GF20...	20	15	—	1	3	—	—	2	7.5
7GN12...	16	15	0.5	1	3	—	—	1.7	5.5
7GN20...	20	20	0.75	2	3	7.5	10	2.5	7.5
7GN25...	25	30	1.5	3	5	10	15	3.7	11
7GN32...	32	40	2	5	10	15	15	4	15
7GN40...	40	50	2	5	10	20	20	6	18.5
7GN63...	63	60	3	10	15	25	25	7.5	30
7GN125...	125	130	5	15	25	50	40	11	45

Series	Rated thermal current I _{th}	UL/CSA general use	UL/CSA horsepower ratings					Max. IEC AC23 power 1 phase	Max. IEC AC23 power 3 phases
			1 phase		3 phases				
			120V [HP]	240V [HP]	240V [HP]	480V [HP]	600V [HP]		
GX16...	16	12	0.75	1	3	5	5	1.8	6.5
GX20...	20	15	0.75	1.5	3	5	5	2.2	7.5
GX32...	32	32	1.5	3	7.5	15	15	3.5	15
GX40...	40	40	2	5	10	15	15	5.2	18.5
GN200	200	200	15	30	50	100	75	—	47
GN315	315	255	15	30	50	100	75	37	110

ON/OFF SWITCHES

Front mounting without front plate with key operation for hole Ø22mm fixing (U12)ⓐ



WIRING DIAGRAMS				90	91	10	92	05	06	07	08	03
Poles				1	2	3	4	1	2	3	4	3
Series	Front plate size [mm]	Rated thermal current Ith [A]	UL/CSA general use [A]									
GF...	—	20	15	GF2090U12	GF2091U12	GF2010U12	GF2092U12	GF2005U12	GF2006U12	GF2007U12	GF2008U12	GF2003U12
7GN...	—	16	15	7GN1290U12	7GN1291U12	7GN1210U12	7GN1292U12	7GN1205U12	7GN1206U12	7GN1207U12	7GN1208U12	7GN1203U12
		20	20	7GN2090U12	7GN2091U12	7GN2010U12	7GN2092U12	7GN2005U12	7GN2006U12	7GN2007U12	7GN2008U12	7GN2003U12
		25	30	7GN2590U12	7GN2591U12	7GN2510U12	7GN2592U12	7GN2505U12	7GN2506U12	7GN2507U12	7GN2508U12	7GN2503U12
GX...	—	16	12	GX1690U12	GX1691U12	GX1610U12	GX1692U12	GX1605U12	GX1606U12	GX1607U12	GX1608U12	GX1603U12
		20	15	GX2090U12	GX2091U12	GX2010U12	GX2092U12	GX2005U12	GX2006U12	GX2007U12	GX2008U12	GX2003U12

Snap on front mounting with black handle for hole Ø22mm fixing (U47)ⓑ

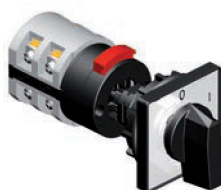

WIRING DIAGRAMS				290	291	210	292	305	306	307	308	303
Poles				1	2	3	4	1	2	3	4	3
Series	Front plate size [mm]	Rated thermal current Ith [A]	UL/CSA general use [A]									
GF...	□30	10	10	GF1090U47	GF1091U47	GF1010U47	GF1092U47	GF1005U47	GF1006U47	GF1007U47	GF1008U47	GF1003U47
	□48	20	15	GF2090U47	GF2091U47	GF2010U47	GF2092U47	GF2005U47	GF2006U47	GF2007U47	GF2008U47	GF2003U47
7GN...	□48	16	15	7GN1290U47	7GN1291U47	7GN1210U47	7GN1292U47	7GN1205U47	7GN1206U47	7GN1207U47	7GN1208U47	7GN1203U47
		20	20	7GN2090U47	7GN2091U47	7GN2010U47	7GN2092U47	7GN2005U47	7GN2006U47	7GN2007U47	7GN2008U47	7GN2003U47
		25	30	7GN2590U47	7GN2591U47	7GN2510U47	7GN2592U47	7GN2505U47	7GN2506U47	7GN2507U47	7GN2508U47	7GN2503U47
GX...	□48	16	12	GX1690U47	GX1691U47	GX1610U47	GX1692U47	GX1605U47	GX1606U47	GX1607U47	GX1608U47	GX1603U47
		20	15	GX2090U47	GX2091U47	GX2010U47	GX2092U47	GX2005U47	GX2006U47	GX2007U47	GX2008U47	GX2003U47

- ⓐ For version with front plate replace U12 with U29 (e.g. GF2090U29).
- ⓑ Standard version provided with 0-1 front plate. For version with 0-1 front plate add C (e.g. GF20C90U12). For version with OFF-ON front plate add D (e.g. GF20D90U12).
- ⓒ For version with OFF-ON front plate add C (e.g. GF20C05U12).
- ⓓ For key operation version replace U47 with U29D (e.g. GF2090U29D).

WIRING DIAGRAMS

90-91-10-92

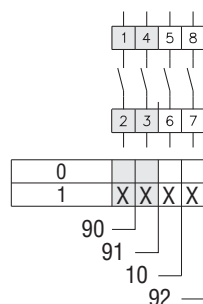

05-06-07-08

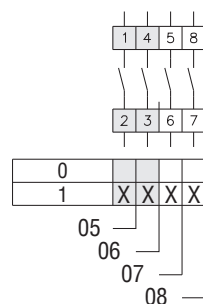

03

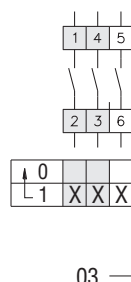

ON/OFF SWITCHES



Rear mounting with black handle (0)

WIRING DIAGRAMS				190	191	110	192	305	306	307	308	303
Poles				1	2	3	4	1	2	3	4	3
Series	Front plate size	Rated thermal current I _{th}	UL/CSA general use									
	[mm]	[A]	[A]									
GF...	□48	20	15	GF20900	GF20910	GF20100	GF20920	GF20050	GF20060	GF20070	GF20080	GF20030
7GN...	□48	16	15	7GN12900	7GN12910	7GN12100	7GN12920	7GN12050	7GN12060	7GN12070	7GN12080	7GN12030
		20	20	7GN20900	7GN20910	7GN20100	7GN20920	7GN20050	7GN20060	7GN20070	7GN20080	7GN20030
		25	30	7GN25900	7GN25910	7GN25100	7GN25920	7GN25050	7GN25060	7GN25070	7GN25080	7GN25030
	□65	32	40	7GN32900	7GN32910	7GN32100	7GN32920	7GN32050	7GN32060	7GN32070	7GN32080	7GN32030
		40	50	7GN40900	7GN40910	7GN40100	7GN40920	7GN40050	7GN40060	7GN40070	7GN40080	7GN40030
	□90	125	130	—	—	7GN63100	7GN63920	—	—	7GN63070	7GN63080	7GN63030
GX...	□48	16	12	GX16900	GX16910	GX16100	GX16920	GX16050	GX16060	GX16070	GX16080	GX16030
		20	15	GX20900	GX20910	GX20100	GX20920	GX20050	GX20060	GX20070	GX20080	GX20030
	□65	32	32	GX32900	GX32910	GX32100	GX32920	GX32050	GX32060	GX32070	GX32080	GX32030
		40	40	GX40900	GX40910	GX40100	GX40920	GX40050	GX40060	GX40070	GX40080	GX40030
GN...	□132	200	200	—	—	GN200100	GN200920	—	—	GN200070	GN200080	GN200030
		315	255	—	—	GN315100	GN315920	—	—	GN315070	GN315080	GN315030



Modular service cover for 35mm DIN rail mounting with black handle (048)Ⓢ

WIRING DIAGRAMS				190	191	110	192	305	306	307	308
Poles				1	2	3	4	1	2	3	4
Series	Enclosure size	Rated thermal current I _{th}	UL/CSA general use								
	[mm]	[A]	[A]								
GF...	45x54	20	15	GF2090048	GF2091048	GF2010048	GF2092048	GF2005048	GF2006048	GF2007048	GF2008048
7GN...	45x54	16	15	7GN1290048	7GN1291048	7GN1210048	7GN1292048	7GN1205048	7GN1206048	7GN1207048	7GN1208048
		20	20	7GN2090048	7GN2091048	7GN2010048	7GN2092048	7GN2005048	7GN2006048	7GN2007048	7GN2008048
		25	30	7GN2590048	7GN2591048	7GN2510048	7GN2592048	7GN2505048	7GN2506048	7GN2507048	7GN2508048
GX...	45x54	16	12	GX1690048	GX1691048	GX1610048	GX1692048	GX1605048	GX1606048	GX1607048	GX1608048
		20	15	GX2090048	GX2091048	GX2010048	GX2092048	GX2005048	GX2006048	GX2007048	GX2008048

- Ⓢ Standard version provided with 0-1 front plate. For version with 0-1 front plate add C (e.g. GF20C900). For version with OFF-ON front plate add D (e.g. GF20D900).
- Ⓢ For key operation version replace 048 with 049 (e.g. GF2090049).
- Ⓢ For version with OFF-ON front plate add C (e.g. GF20C050).

Technical characteristics

Series	Rated thermal current I _{th}	UL/CSA general use	UL/CSA horsepower ratings					Max. IEC AC23 power 1 phase	Max. IEC AC23 power 3 phases
			1 phase		3 phases				
			120V [HP]	240V [HP]	240V [HP]	480V [HP]	600V [HP]		
GF10...	10	10	—	0.75	2	—	—	0.75	3
GF20...	20	15	—	1	3	—	—	2	7.5
7GN12...	16	15	0.5	1	3	—	—	1.7	5.5
7GN20...	20	20	0.75	2	3	7.5	10	2.5	7.5
7GN25...	25	30	1.5	3	5	10	15	3.7	11
7GN32...	32	40	2	5	10	15	15	4	15
7GN40...	40	50	2	5	10	20	20	6	18.5
7GN63...	63	60	3	10	15	25	25	7.5	30
7GN125...	125	130	5	15	25	50	40	11	45
Series	Rated thermal current I _{th}	UL/CSA general use	UL/CSA horsepower ratings					Max. IEC AC23 power 1 phase	Max. IEC AC23 power 3 phases
			1 phase		3 phases				
			120V [HP]	240V [HP]	240V [HP]	480V [HP]	600V [HP]		
GX16...	16	12	0.75	1	3	5	5	1.8	6.5
GX20...	20	15	0.75	1.5	3	5	5	2.2	7.5
GX32...	32	32	1.5	3	7.5	15	15	3.5	15
GX40...	40	40	2	5	10	15	15	5.2	18.5
GN200	200	200	15	30	50	100	75	—	47
GN315	315	255	15	30	50	100	75	37	110

ON/OFF SWITCHES

Rear mounting with red/yellow handle padlockable in 0, door coupling and protection covers (088)

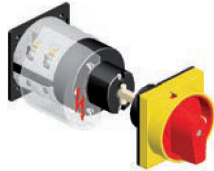

WIRING DIAGRAMS				190	191	110	192	205	206	207	208
Poles				1	2	3	4	1	2	3	4
Series	Front plate size	Rated thermal current I _{th}	UL/CSA general use								
	[mm]	[A]	[A]								
GF...	□48	20	15	GF2090088	GF2091088	GF2010088	GF2092088	GF2005088	GF2006088	GF2007088	GF2008088
7GN...	□65	16	15	7GN1290088	7GN1291088	7GN1210088	7GN1292088	7GN1205088	7GN1206088	7GN1207088	7GN1208088
		20	20	7GN2090088	7GN2091088	7GN2010088	7GN2092088	7GN2005088	7GN2006088	7GN2007088	7GN2008088
		25	30	7GN2590088	7GN2591088	7GN2510088	7GN2592088	7GN2505088	7GN2506088	7GN2507088	7GN2508088
		32	40	7GN3290088	7GN3291088	7GN3210088	7GN3292088	7GN3205088	7GN3206088	7GN3207088	7GN3208088
		40	50	7GN4090088	7GN4091088	7GN4010088	7GN4092088	7GN4005088	7GN4006088	7GN4007088	7GN4008088
GX...	□48	16	12	GX1690088	GX1691088	GX1610088	GX1692088	GX1605088	GX1606088	GX1607088	GX1608088
		20	15	GX2090088	GX2091088	GX2010088	GX2092088	GX2005088	GX2006088	GX2007088	GX2008088
	□65	32	32	GX3290088	GX3291088	GX3210088	GX3292088	GX3205088	GX3206088	GX3207088	GX3208088
		40	40	GX4090088	GX4091088	GX4010088	GX4092088	GX4005088	GX4006088	GX4007088	GX4008088

Rear mounting with red/yellow handle padlockable in 0, door coupling and protection covers (098)



WIRING DIAGRAMS				190	191	110	192	205	206	207	208
Poles				1	2	3	4	1	2	3	4
Series	Front plate size	Rated thermal current I _{th}	UL/CSA general use								
	[mm]	[A]	[A]								
7GN...	□65	16	15	7GN1290098	7GN1291098	7GN1210098	7GN1292098	7GN1205098	7GN1206098	7GN1207098	7GN1208098
		20	20	7GN2090098	7GN2091098	7GN2010098	7GN2092098	7GN2005098	7GN2006098	7GN2007098	7GN2008098
		25	30	7GN2590098	7GN2591098	7GN2510098	7GN2592098	7GN2505098	7GN2506098	7GN2507098	7GN2508098
		32	40	7GN3290098	7GN3291098	7GN3210098	7GN3292098	7GN3205098	7GN3206098	7GN3207098	7GN3208098
		40	50	7GN4090098	7GN4091098	7GN4010098	7GN4092098	7GN4005098	7GN4006098	7GN4007098	7GN4008098
		63	60	—	—	7GN6310098	7GN6392098	—	—	7GN6307098	7GN6308098

● Standard version provided with 0-1 front plate. For version with 0-1 front plate add C (e.g. GF20C90088). For version with OFF-ON front plate add D (e.g. GF20D90088).

● For version with OFF-ON front plate add C (e.g. GF20C05088).

WIRING DIAGRAMS

90-91-10-92

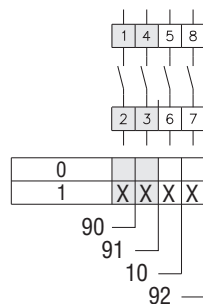

05-06-07-08

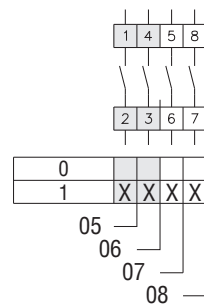

03

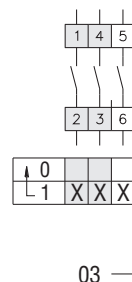

ON/OFF SWITCHES

Cam switch in plastic enclosure with black handle (P)

Cam switch in metallic enclosure with black handle (L)



WIRING DIAGRAMS				190	191	110	192	205	206	207	208	203
Poles				1	2	3	4	1	2	3	4	3
Series	Enclosure size	Rated thermal current I _{th}	UL/CSA general use									
	[mm]	[A]	[A]									
7GN...	75x75	16	15	7GN1290P	7GN1291P	7GN1210P	7GN1292P	7GN1205P	7GN1206P	7GN1207P	7GN1208P	7GN1203P
		20	20	7GN2090P	7GN2091P	7GN2010P	7GN2092P	7GN2005P	7GN2006P	7GN2007P	7GN2008P	7GN2003P
		25	30	7GN2590P	7GN2591P	7GN2510P	7GN2592P	7GN2505P	7GN2506P	7GN2507P	7GN2508P	7GN2503P
	90x90	32	40	7GN3290P	7GN3291P	7GN3210P	7GN3292P	7GN3205P	7GN3206P	7GN3207P	7GN3208P	7GN3203P
	110x110	40	50	7GN4090P	7GN4091P	7GN4010P	7GN4092P	7GN4005P	7GN4006P	7GN4007P	7GN4008P	7GN4003P
	125x175	63	60	—	—	7GN6310P	7GN6392P	—	—	7GN6307P	7GN6308P	7GN6303P
	180x254	125	130	—	—	7GN12510P	7GN12592P	—	—	7GN12507P	7GN12508P	7GN12503P
GX...	90x90	16	12	GX1690P	GX1691P	GX1610P	GX1692P	GX1605P	GX1606P	GX1607P	GX1608P	GX1603P
		20	15	GX2090P	GX2091P	GX2010P	GX2092P	GX2005P	GX2006P	GX2007P	GX2008P	GX2003P
	110x110	32	32	GX3290P	GX3291P	GX3210P	GX3292P	GX3205P	GX3206P	GX3207P	GX3208P	GX3203P
		40	40	GX4090P	GX4091P	GX4010P	GX4092P	GX4005P	GX4006P	GX4007P	GX4008P	GX4003P
GN...	250x316	200	200	—	—	GN20010L	GN20092L	—	—	GN20007L	GN20008L	GN20003L
		315	255	—	—	GN31510L	GN31592L	—	—	GN31507L	GN31508L	GN31503L

Cam switch in plastic enclosure with red/yellow handle (P25)



WIRING DIAGRAMS				190	191	110	192	205	206	207	208
Poles				1	2	3	4	1	2	3	4
Series	Enclosure size	Rated thermal current I _{th}	UL/CSA general use								
	[mm]	[A]	[A]								
7GN...	75x75 or 90x90 [Ⓢ]	16	15	7GN1290P25	7GN1291P25	7GN1210P25	7GN1292P25	7GN1205P25	7GN1206P25	7GN1207P25	7GN1208P25
		20	20	7GN2090P25	7GN2091P25	7GN2010P25	7GN2092P25	7GN2005P25	7GN2006P25	7GN2007P25	7GN2008P25
		25	30	7GN2590P25	7GN2591P25	7GN2510P25	7GN2592P25	7GN2505P25	7GN2506P25	7GN2507P25	7GN2508P25
	90x90	32	40	7GN3290P25	7GN3291P25	7GN3210P25	7GN3292P25	7GN3205P25	7GN3206P25	7GN3207P25	7GN3208P25
	110x110	40	50	7GN4090P25	7GN4091P25	7GN4010P25	7GN4092P25	7GN4005P25	7GN4006P25	7GN4007P25	7GN4008P25
	125x175	63	60	—	—	7GN6310P25	7GN6392P25	—	—	7GN6307P25	7GN6308P25
	180x254	125	130	—	—	7GN12510P25	—	—	—	7GN12507P25	7GN12508P25
GX...	90x90	16	12	GX1690P25	GX1691P25	GX1610P25	GX1692P25	GX1605P25	GX1606P25	GX1607P25	GX1608P25
		20	15	GX2090P25	GX2091P25	GX2010P25	GX2092P25	GX2005P25	GX2006P25	GX2007P25	GX2008P25
	110x110	32	32	GX3290P25	GX3291P25	GX3210P25	GX3292P25	GX3205P25	GX3206P25	GX3207P25	GX3208P25
		40	40	GX4090P25	GX4091P25	GX4010P25	GX4092P25	GX4005P25	GX4006P25	GX4007P25	GX4008P25

Ⓢ Standard version provided with 0-1 front plate. For version with 0-1 front plate add C (e.g. 7GN12C90P). For version with OFF-ON front plate add D (e.g. 7GN12D90P).

Ⓣ For version with OFF-ON front plate add C (e.g. 7GN12C05P).

Ⓤ Standard enclosure is 90X90mm. 75x75mm enclosure is available by adding B0 at the end of the part number. E.g. 7GN1290P25B0.

Technical characteristics

Series	Rated thermal current I _{th}	UL/CSA general use	UL/CSA horsepower ratings					Max. IEC AC23 power 1 phase [kW] at 230V	Max. IEC AC23 power 3 phases [kW] at 400V
			1 phase		3 phases				
			120V [HP]	240V [HP]	240V [HP]	480V [HP]	600V [HP]		
GF20...	20	15	—	1	3	—	—	2	7.5
7GN12...	16	15	0.5	1	3	—	—	1.7	5.5
7GN20...	20	20	0.75	2	3	7.5	10	2.5	7.5
7GN25...	25	30	1.5	3	5	10	15	3.7	11
7GN32...	32	40	2	5	10	15	15	4	15
7GN40...	40	50	2	5	10	20	20	6	18.5
7GN63...	63	60	3	10	15	25	25	7.5	30
7GN125...	125	130	5	15	25	50	40	11	45
GX16...	16	12	0.75	1	3	5	5	1.8	6.5
GX20...	20	15	0.75	1.5	3	5	5	2.2	7.5
GX32...	32	32	1.5	3	7.5	15	15	3.5	15
GX40...	40	40	2	5	10	15	15	5.2	18.5
GN200	200	200	15	30	50	100	75	—	47
GN315	315	255	15	30	50	100	75	37	110

CHANGEOVER SWITCHES WITH OR WITHOUT 0

Front mounting with black handle (U)



Type				Changeover switches with 0				Changeover switches without 0			
WIRING DIAGRAMS				51	52	53	75	54	55	56	69
Poles				1	2	3	4	1	2	3	4
Series	Front plate size	Rated thermal current Ith	UL/CSA general use								
	[mm]	[A]	[A]								
GF...	□30	10	10	GF1051U	GF1052U	GF1053U	GF1075U	GF1054U	GF1055U	GF1056U	GF1069U
	□48	20	15	GF2051U	GF2052U	GF2053U	GF2075U	GF2054U	GF2055U	GF2056U	GF2069U
7GN...	□48	16	15	7GN1251U	7GN1252U	7GN1253U	7GN1275U	7GN1254U	7GN1255U	7GN1256U	7GN1269U
		20	20	7GN2051U	7GN2052U	7GN2053U	7GN2075U	7GN2054U	7GN2055U	7GN2056U	7GN2069U
		25	30	7GN2551U	7GN2552U	7GN2553U	7GN2575U	7GN2554U	7GN2555U	7GN2556U	7GN2569U
	□65	32	40	7GN3251U	7GN3252U	7GN3253U	7GN3275U	7GN3254U	7GN3255U	7GN3256U	7GN3269U
		40	50	7GN4051U	7GN4052U	7GN4053U	7GN4075U	7GN4054U	7GN4055U	7GN4056U	7GN4069U
		63	60	—	7GN6352U	7GN6353U	7GN6375U	—	7GN6355U	7GN6356U	7GN6369U
□90	125	130	—	7GN12552U	7GN12553U	7GN12575U	—	7GN12555U	7GN12556U	7GN12569U	
GX...	□48	16	12	GX1651U	GX1652U	GX1653U	GX1675U	GX1654U	GX1655U	GX1656U	GX1669U
		20	15	GX2051U	GX2052U	GX2053U	GX2075U	GX2054U	GX2055U	GX2056U	GX2069U
	□65	32	32	GX3251U	GX3252U	GX3253U	GX3275U	GX3254U	GX3255U	GX3256U	GX3269U
	40	40	GX4051U	GX4052U	GX4053U	GX4075U	GX4054U	GX4055U	GX4056U	GX4069U	
GN...	□132	200	200	—	GN20052U	GN20053U	GN20075U	—	GN20055U	GN20056U	GN20069U
		315	255	—	GN31552U	GN31553U	GN31575U	—	GN31555U	GN31556U	GN31569U

Front mounting with black handle without front plate for hole Ø22mm fixing (U11)



Type				Changeover switches with 0				Changeover switches without 0			
WIRING DIAGRAMS				51	52	53	75	54	55	56	69
Poles				1	2	3	4	1	2	3	4
Series	Front plate size	Rated thermal current Ith	UL/CSA general use								
	[mm]	[A]	[A]								
GF	—	20	15	GF2051U11	GF2052U11	GF2053U11	GF2075U11	GF2054U11	GF2055U11	GF2056U11	GF2069U11
7GN...	—	16	15	7GN1251U11	7GN1252U11	7GN1253U11	7GN1275U11	7GN1254U11	7GN1255U11	7GN1256U11	7GN1269U11
		20	20	7GN2051U11	7GN2052U11	7GN2053U11	7GN2075U11	7GN2054U11	7GN2055U11	7GN2056U11	7GN2069U11
		25	30	7GN2551U11	7GN2552U11	7GN2553U11	7GN2575U11	7GN2554U11	7GN2555U11	7GN2556U11	7GN2569U11
GX...	—	16	12	GX1651U11	GX1652U11	GX1653U11	GX1675U11	GX1654U11	GX1655U11	GX1656U11	GX1669U11
		20	15	GX2051U11	GX2052U11	GX2053U11	GX2075U11	GX2054U11	GX2055U11	GX2056U11	GX2069U11

• For version with MAN-O-AUTO front plate add D (e.g. GF10D51U).

WIRING DIAGRAMS

51-52-53-75

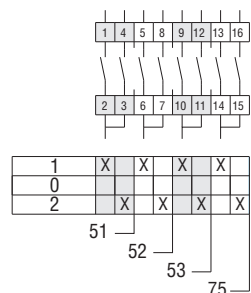

54-55-56-69

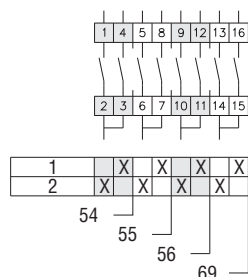

CHANGEOVER SWITCHES WITH OR WITHOUT 0

Front mounting without front plate with key operation for hole Ø22mm fixing (U12)⓪



Type				Changeover switches with 0				Changeover switches without 0			
WIRING DIAGRAMS				51	52	53	75	54	55	56	69
Poles				1	2	3	4	1	2	3	4
Series	Front plate size	Rated thermal current I _{th}	UL/CSA general use								
	[mm]										
GF	—	20	15	GF2051U12	GF2052U12	GF2053U12	GF2075U12	GF2054U12	GF2055U12	GF2056U12	GF2069U12
7GN...	—	16	15	7GN1251U12	7GN1252U12	7GN1253U12	7GN1275U12	7GN1254U12	7GN1255U12	7GN1256U12	7GN1269U12
		20	20	7GN2051U12	7GN2052U12	7GN2053U12	7GN2075U12	7GN2054U12	7GN2055U12	7GN2056U12	7GN2069U12
		25	30	7GN2551U12	7GN2552U12	7GN2553U12	7GN2575U12	7GN2554U12	7GN2555U12	7GN2556U12	7GN2569U12
GX...	—	16	12	GX1651U12	GX1652U12	GX1653U12	GX1675U12	GX1654U12	GX1655U12	GX1656U12	GX1669U12
		20	15	GX2051U12	GX2052U12	GX2053U12	GX2075U12	GX2054U12	GX2055U12	GX2056U12	GX2069U12

Snap on front mounting with black handle for hole Ø22mm fixing (U47)⓪



Type				Changeover switches with 0				Changeover switches without 0			
WIRING DIAGRAMS				51	52	53	75	54	55	56	69
Poles				1	2	3	4	1	2	3	4
Series	Front plate size	Rated thermal current I _{th}	UL/CSA general use								
	[mm]										
GF	□30	10	10	GF1051U47	GF1052U47	GF1053U47	GF1075U47	GF1054U47	GF1055U47	GF1056U47	GF1069U47
	□48	20	15	GF2051U47	GF2052U47	GF2053U47	GF2075U47	GF2054U47	GF2055U47	GF2056U47	GF2069U47
7GN...	□48	16	15	7GN1251U47	7GN1252U47	7GN1253U47	7GN1275U47	7GN1254U47	7GN1255U47	7GN1256U47	7GN1269U47
		20	20	7GN2051U47	7GN2052U47	7GN2053U47	7GN2075U47	7GN2054U47	7GN2055U47	7GN2056U47	7GN2069U47
		25	30	7GN2551U47	7GN2552U47	7GN2553U47	7GN2575U47	7GN2554U47	7GN2555U47	7GN2556U47	7GN2569U47
GX...	□48	16	12	GX1651U47	GX1652U47	GX1653U47	GX1675U47	GX1654U47	GX1655U47	GX1656U47	GX1669U47
		20	15	GX2051U47	GX2052U47	GX2053U47	GX2075U47	GX2054U47	GX2055U47	GX2056U47	GX2069U47

- ⓪ For version with front plate replace U12 with U29 (e.g. GF2051U29).
- ⓪ For version with MAN-O-AUTO front plate add D (e.g. GF20D51U12).
- ⓪ For key operation version replace U47 with U29D (e.g. GF2051U29D).

Technical characteristics

Series	Rated thermal current I _{th}	UL/CSA general use	UL/CSA horsepower ratings					Max. IEC AC23 power 1 phase	Max. IEC AC23 power 3 phases
			1 phase		3 phases				
			120V [HP]	240V [HP]	240V [HP]	480V [HP]	600V [HP]		
GF10...	10	10	—	0.75	2	—	—	0.75	3
GF20...	20	15	—	1	3	—	—	2	7.5
7GN12...	16	15	0.5	1	3	—	—	1.7	5.5
7GN20...	20	20	0.75	2	3	7.5	10	2.5	7.5
7GN25...	25	30	1.5	3	5	10	15	3.7	11
7GN32...	32	40	2	5	10	15	15	4	15
7GN40...	40	50	2	5	10	20	20	6	18.5
7GN63...	63	60	3	10	15	25	25	7.5	30
7GN125...	125	130	5	15	25	50	40	11	45
Series	Rated thermal current I _{th}	UL/CSA general use	UL/CSA horsepower ratings					Max. IEC AC23 power 1 phase	Max. IEC AC23 power 3 phases
			1 phase		3 phases				
			120V [HP]	240V [HP]	240V [HP]	480V [HP]	600V [HP]		
GX16...	16	12	0.75	1	3	5	5	1.8	6.5
GX20...	20	15	0.75	1.5	3	5	5	2.2	7.5
GX32...	32	32	1.5	3	7.5	15	15	3.5	15
GX40...	40	40	2	5	10	15	15	5.2	18.5
GN200	200	200	15	30	50	100	75	—	47
GN315	315	255	15	30	50	100	75	37	110

11 Rotary cam switches

Switching

CHANGEOVER SWITCHES WITH OR WITHOUT 0

Rear mounting with black handle (0)

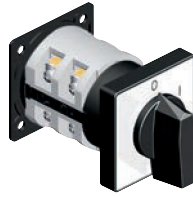

Type				Changeover switches with 0				Changeover switches without 0			
WIRING DIAGRAMS				151	152	153	175	54	55	56	69
Poles				1	2	3	4	1	2	3	4
Series	Front plate size	Rated thermal current Ith	UL/CSA general use								
	[mm]	[A]	[A]								
GF...	48	20	15	GF20510	GF20520	GF20530	GF20750	GF20540	GF20550	GF20560	GF20690
7GN...	48	16	15	7GN12510	7GN12520	7GN12530	7GN12750	7GN12540	7GN12550	7GN12560	7GN12690
		20	20	7GN20510	7GN20520	7GN20530	7GN20750	7GN20540	7GN20550	7GN20560	7GN20690
		25	30	7GN25510	7GN25520	7GN25530	7GN25750	7GN25540	7GN25550	7GN25560	7GN25690
	65	32	40	7GN32510	7GN32520	7GN32530	7GN32750	7GN32540	7GN32550	7GN32560	7GN32690
		40	50	7GN40510	7GN40520	7GN40530	7GN40750	7GN40540	7GN40550	7GN40560	7GN40690
	63	60	—	7GN63520	7GN63530	7GN63750	—	7GN63550	7GN63560	7GN63690	
	90	125	130	—	7GN125520	7GN125530	7GN125750	—	7GN125550	7GN125560	7GN125690
GX...	48	16	12	GX16510	GX16520	GX16530	GX16750	GX16540	GX16550	GX16560	GX16690
		20	15	GX20510	GX20520	GX20530	GX20750	GX20540	GX20550	GX20560	GX20690
	65	32	32	GX32510	GX32520	GX32530	GX32750	GX32540	GX32550	GX32560	GX32690
40		40	GX40510	GX40520	GX40530	GX40750	GX40540	GX40550	GX40560	GX40690	
GN...	132	200	200	—	GN200520	GN200530	GN200750	—	GN200550	GN200560	GN200690
		315	255	—	GN315520	GN315530	GN315750	—	GN315550	GN315560	GN315690

Modular service cover for 35mm DIN rail mounting with black handle (048)Ⓜ



Type				Changeover switches with 0				Changeover switches without 0			
WIRING DIAGRAMS				151	152	153	175	54	55	56	69
Poles				1	2	3	4	1	2	3	4
Series	Front plate size	Rated thermal current Ith	UL/CSA general use								
	[mm]	[A]	[A]								
GF	45x54	20	15	GF2051048	GF2052048	GF2053048	GF2075048	GF2054048	GF2055048	GF2056048	GF2069048
7GN...	45x54	16	15	7GN1251048	7GN1252048	7GN1253048	7GN1275048	7GN1254048	7GN1255048	7GN1256048	7GN1269048
		20	20	7GN2051048	7GN2052048	7GN2053048	7GN2075048	7GN2054048	7GN2055048	7GN2056048	7GN2069048
		25	30	7GN2551048	7GN2552048	7GN2553048	7GN2575048	7GN2554048	7GN2555048	7GN2556048	7GN2569048
GX...	45x54	16	12	GX1651048	GX1652048	GX1653048	GX1675048	GX1654048	GX1655048	GX1656048	GX1669048
		20	15	GX2051048	GX2052048	GX2053048	GX2075048	GX2054048	GX2055048	GX2056048	GX2069048

- 1 For version with MAN-O-AUTO front plate add D (e.g. GF20D510).
- Ⓜ For key operation version replace 048 with 049 (e.g. GF2051049).

WIRING DIAGRAMS

51-52-53-75

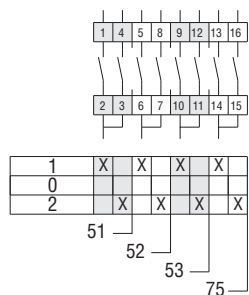

54-55-56-69

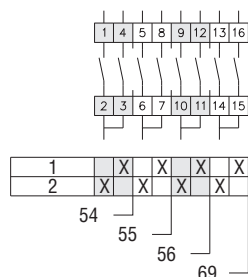

CHANGEOVER SWITCHES WITH OR WITHOUT 0

Cam switch in plastic enclosure with black handle (P)

Cam switch in metallic enclosure with black handle (L)



Type				Changeover switches with 0				Changeover switches without 0			
WIRING DIAGRAMS				151	152	153	175	54	55	56	69
Poles				1	2	3	4	1	2	3	4
Series	Enclosure size [mm]	Rated thermal current I _{th} [A]	UL/CSA general use [A]								
				7GN...	75x75	16	15	7GN1251P	7GN1252P	7GN1253P	7GN1275P
		20	20	7GN2051P	7GN2052P	7GN2053P	7GN2075P	7GN2054P	7GN2055P	7GN2056P	7GN2069P
		25	30	7GN2551P	7GN2552P	7GN2553P	7GN2575P [Ⓢ]	7GN2554P	7GN2555P	7GN2556P	7GN2569P [Ⓢ]
	90x90	32	40	7GN3251P	7GN3252P	7GN3253P	7GN3275P	7GN3254P	7GN3255P	7GN3256P	7GN3269P
	110x110	40	50	7GN4051P	7GN4052P	7GN4053P	7GN4075P	7GN4054P	7GN4055P	7GN4056P	7GN4069P
	125x175	63	60	—	7GN6352P	7GN6353P	7GN6375P	—	7GN6355P	7GN6356P	7GN6369P
	180x254	125	130	—	7GN12552P	7GN12553P	7GN12575P	—	7GN12555P	7GN12556P	7GN12569P
GX...	90x90	16	12	GX1651P	GX1652P	GX1653P	GX1675P	GX1654P	GX1655P	GX1656P	GX1669P
		20	15	GX2051P	GX2052P	GX2053P	GX2075P	GX2054P	GX2055P	GX2056P	GX2069P
	110x110	32	32	GX3251P	GX3252P	GX3253P	GX3275P	GX3254P	GX3255P	GX3256P	GX3269P
		40	40	GX4051P	GX4052P	GX4053P	GX4075P	GX4054P	GX4055P	GX4056P	GX4069P
GN...	250x316	200	200	—	GN20052L	GN20053L	GN20075L	—	GN20055L	GN20056L	GN20069L
		315	255	—	GN31552L	GN31553L	GN31575L	—	GN31555L	GN31556L	GN31569L

- Ⓢ For version with MAN-O-AUTO front plate add D (e.g. 7GN12D51P).
- Ⓢ Enclosure size 90x90mm.

Technical characteristics

Series	Rated thermal current I _{th} [A]	UL/CSA general use [A]	UL/CSA horsepower ratings					Max. IEC AC23 power 1 phase [kW] at 230V	Max. IEC AC23 power 3 phases [kW] at 400V
			1 phase		3 phases				
			120V [HP]	240V [HP]	240V [HP]	480V [HP]	600V [HP]		
GF20...	20	15	—	1	3	—	—	2	7.5
7GN12...	16	15	0.5	1	3	—	—	1.7	5.5
7GN20...	20	20	0.75	2	3	7.5	10	2.5	7.5
7GN25...	25	30	1.5	3	5	10	15	3.7	11
7GN32...	32	40	2	5	10	15	15	4	15
7GN40...	40	50	2	5	10	20	20	6	18.5
7GN63...	63	60	3	10	15	25	25	7.5	30
7GN125...	125	130	5	15	25	50	40	11	45
GX16...	16	12	0.75	1	3	5	5	1.8	6.5
GX20...	20	15	0.75	1.5	3	5	5	2.2	7.5
GX32...	32	32	1.5	3	7.5	15	15	3.5	15
GX40...	40	40	2	5	10	15	15	5.2	18.5
GN200	200	200	15	30	50	100	75	—	47
GN315	315	255	15	30	50	100	75	37	110

11 Rotary cam switches

Multi-step

STARTING WITH 1



Front mounting with black handle (U)

WIRING DIAGRAMS				82	86	93	83	87	94	84	85
Poles				1	2	3	1	2	3	1	1
Series	Front plate size	Rated thermal current I _{th}	UL/CSA general use								
	[mm]	[A]	[A]								
GF...	□30	10	10	GF1082U	GF1086U	GF1093U	GF1083U	GF1087U	GF1094U	GF1084U	GF1085U
	□48	20	15	GF2082U	GF2086U	GF2093U	GF2083U	GF2087U	GF2094U	GF2084U	GF2085U
7GN...	□48	16	15	7GN1282U	7GN1286U	7GN1293U	7GN1283U	7GN1287U	7GN1294U	7GN1284U	7GN1285U
		20	20	7GN2082U	7GN2086U	7GN2093U	7GN2083U	7GN2087U	7GN2094U	7GN2084U	7GN2085U
		25	30	7GN2582U	7GN2586U	7GN2593U	7GN2583U	7GN2587U	7GN2594U	7GN2584U	7GN2585U
	□65	32	40	7GN3282U	7GN3286U	7GN3293U	7GN3283U	7GN3287U	7GN3294U	7GN3284U	7GN3285U
		40	50	7GN4082U	7GN4086U	7GN4093U	7GN4083U	7GN4087U	7GN4094U	7GN4084U	7GN4085U
		63	60	7GN6382U	7GN6386U	7GN6393U	7GN6383U	7GN6387U	7GN6394U	7GN6384U	7GN6385U
□90	125	130	7GN12582U	7GN12586U	7GN12593U	7GN12583U	7GN12587U	7GN12594U	7GN12584U	7GN12585U	
GX...	□48	16	12	GX1682U	GX1686U	GX1693U	GX1683U	GX1687U	GX1694U	GX1684U	GX1685U
		20	15	GX2082U	GX2086U	GX2093U	GX2083U	GX2087U	GX2094U	GX2084U	GX2085U
	□65	32	32	GX3282U	GX3286U	GX3293U	GX3283U	GX3287U	GX3294U	GX3284U	GX3285U
40		40	GX4082U	GX4086U	GX4093U	GX4083U	GX4087U	GX4094U	GX4084U	GX4085U	
GN...	□132	200	200	GN20082U	GN20086U	GN20093U	GN20083U	GN20087U	GN20094U	GN20084U	GN20085U
		315	255	GN31582U	GN31586U	GN31593U	GN31583U	GN31587U	GN31594U	GN31584U	GN31585U

WIRING DIAGRAMS

82-86-93

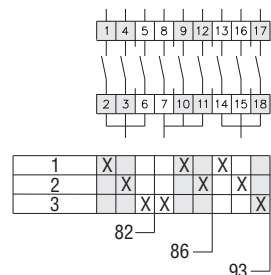

83-87-94

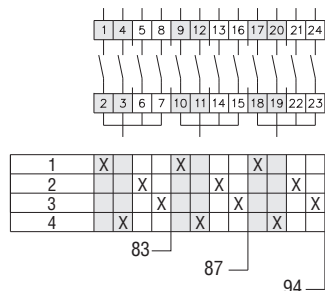

84

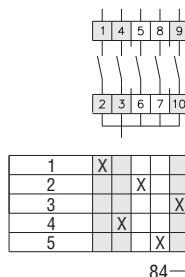

85

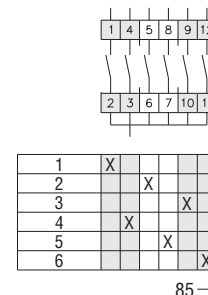

STARTING WITH 1



Snap on front mounting with black handle for hole Ø22mm fixing (U47) ❶

WIRING DIAGRAMS				82	86	93	83	87	94	84	85	
Poles				1	2	3	1	2	3	1	1	
Series	Front plate size	Rated thermal current I _{th}	UL/CSA general use									
	[mm]			[A]	[A]							
GF...	□30	10	10	GF1082U47	GF1086U47	GF1093U47	GF1083U47	GF1087U47	GF1094U47	GF1084U47	GF1085U47	
	□48	20	15	GF2082U47	GF2086U47	GF2093U47	GF2083U47	GF2087U47	GF2094U47	GF2084U47	GF2085U47	
7GN...	□48	16	15	7GN1282U47	7GN1286U47	7GN1293U47	7GN1283U47	7GN1287U47	7GN1294U47	7GN1284U47	7GN1285U47	
		20	20	7GN2082U47	7GN2086U47	7GN2093U47	7GN2083U47	7GN2087U47	7GN2094U47	7GN2084U47	7GN2085U47	
		25	30	7GN2582U47	7GN2586U47	7GN2593U47	7GN2583U47	7GN2587U47	7GN2594U47	7GN2584U47	7GN2585U47	
GX...	□48	16	12	GX1682U47	GX1686U47	GX1693U47	GX1683U47	GX1687U47	GX1694U47	GX1684U47	GX1685U47	
		20	15	GX2082U47	GX2086U47	GX2093U47	GX2083U47	GX2087U47	GX2094U47	GX2084U47	GX2085U47	

❶ For key operation version replace U47 with U29D (e.g. GF2082U29D).

Technical characteristics

Series	Rated thermal current I _{th}	UL/CSA general use	UL/CSA horsepower ratings					Max. IEC AC23 power 1 phase	Max. IEC AC23 power 3 phases
			1 phase		3 phases				
	[A]	[A]	120V [HP]	240V [HP]	240V [HP]	480V [HP]	600V [HP]	[kW] at 230V	[kW] at 400V
GF10...	10	10	—	0.75	2	—	—	0.75	3
GF20...	20	15	—	1	3	—	—	2	7.5
7GN12...	16	15	0.5	1	3	—	—	1.7	5.5
7GN20...	20	20	0.75	2	3	7.5	10	2.5	7.5
7GN25...	25	30	1.5	3	5	10	15	3.7	11
7GN32...	32	40	2	5	10	15	15	4	15
7GN40...	40	50	2	5	10	20	20	6	18.5
7GN63...	63	60	3	10	15	25	25	7.5	30
7GN125...	125	130	5	15	25	50	40	11	45

Series	Rated thermal current I _{th}	UL/CSA general use	UL/CSA horsepower ratings					Max. IEC AC23 power 1 phase	Max. IEC AC23 power 3 phases
			1 phase		3 phases				
	[A]	[A]	120V [HP]	240V [HP]	240V [HP]	480V [HP]	600V [HP]	[kW] at 230V	[kW] at 400V
GX16...	16	12	0.75	1	3	5	5	1.8	6.5
GX20...	20	15	0.75	1.5	3	5	5	2.2	7.5
GX32...	32	32	1.5	3	7.5	15	15	3.5	15
GX40...	40	40	2	5	10	15	15	5.2	18.5
GN200	200	200	15	30	50	100	75	—	47
GN315	315	255	15	30	50	100	75	37	110

11 Rotary cam switches

Multi-step

STARTING WITH 1

Rear mounting with black handle (0)



WIRING DIAGRAMS				82	86	93	83	87	94	84	85
Poles				1	2	3	1	2	3	1	1
Series	Front plate size	Rated thermal current I _{th}	UL/CSA general use								
	[mm]	[A]	[A]								
GF...	□48	20	15	GF20820	GF20860	GF20930	GF20830	GF20870	GF20940	GF20840	GF20850
7GN...	□48	16	15	7GN12820	7GN12860	7GN12930	7GN12830	7GN12870	7GN12940	7GN12840	7GN12850
		20	20	7GN20820	7GN20860	7GN20930	7GN20830	7GN20870	7GN20940	7GN20840	7GN20850
		25	30	7GN25820	7GN25860	7GN25930	7GN25830	7GN25870	7GN25940	7GN25840	7GN25850
	□65	32	40	7GN32820	7GN32860	7GN32930	7GN32830	7GN32870	7GN32940	7GN32840	7GN32850
		40	50	7GN40820	7GN40860	7GN40930	7GN40830	7GN40870	7GN40940	7GN40840	7GN40850
□90	125	130	7GN125820	7GN125860	7GN125930	7GN125830	7GN125870	7GN125940	7GN125840	7GN125850	
GX...	□48	16	12	GX16820	GX16860	GX16930	GX16830	GX16870	GX16940	GX16840	GX16850
		20	15	GX20820	GX20860	GX20930	GX20830	GX20870	GX20940	GX20840	GX20850
	□65	32	32	GX32820	GX32860	GX32930	GX32830	GX32870	GX32940	GX32840	GX32850
		40	40	GX40820	GX40860	GX40930	GX40830	GX40870	GX40940	GX40840	GX40850
GN...	□132	200	200	GN200820	GN200860	GN200930	GN200830	GN200870	GN200940	GN200840	GN200850
		315	255	GN315820	GN315860	GN315930	GN315830	GN315870	GN315940	GN315840	GN315850

Modular service cover for 35mm DIN rail mounting with black handle (048)⓪



WIRING DIAGRAMS				82	86	93	83	87	94	84	85
Poles				1	2	3	1	2	3	1	1
Series	Enclosure size	Rated thermal current I _{th}	UL/CSA general use								
	[mm]	[A]	[A]								
GF...	45x54	20	15	GF2082048	GF2086048	GF2093048	GF2083048	GF2087048	GF2094048	GF2084048	GF2085048
7GN...	45x54	16	15	7GN1282048	7GN1286048	7GN1293048	7GN1283048	7GN1287048	7GN1294048	7GN1284048	7GN1285048
		20	20	7GN2082048	7GN2086048	7GN2093048	7GN2083048	7GN2087048	7GN2094048	7GN2084048	7GN2085048
		25	30	7GN2582048	7GN2586048	7GN2593048	7GN2583048	7GN2587048	7GN2594048	7GN2584048	7GN2585048
GX...	45x54	16	12	GX1682048	GX1686048	GX1693048	GX1683048	GX1687048	GX1694048	GX1684048	GX1685048
		20	15	GX2082048	GX2086048	GX2093048	GX2083048	GX2087048	GX2094048	GX2084048	GX2085048

⓪ For key operation version replace 048 with 049 (e.g. GF2082049).

WIRING DIAGRAMS

82-86-93

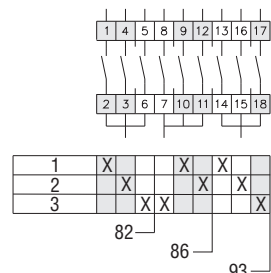

83-87-94

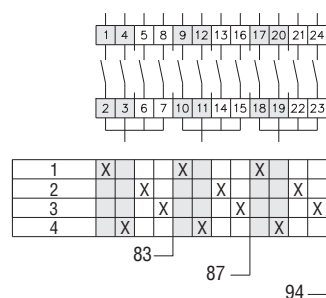

84

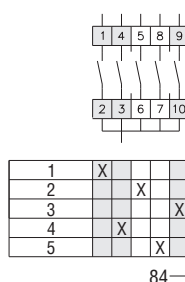

85

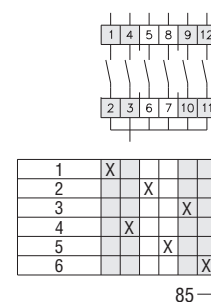

STARTING WITH 1

Cam switch in plastic enclosure with black handle (P)

Cam switch in metallic enclosure with black handle (L)



WIRING DIAGRAMS				82	86	93	83	87	94	84	85	
Poles				1	2	3	1	2	3	1	1	
Series	Enclosure size	Rated thermal current I _{th}	UL/CSA general use									
	[mm]	[A]	[A]									
7GN...	75x75	16	15	7GN1282P	7GN1286P	7GN1293P ^①	7GN1283P	7GN1287P	7GN1294P ^①	7GN1284P	7GN1285P	
		20	20	7GN2082P	7GN2086P	7GN2093P ^①	7GN2083P	7GN2087P	7GN2094P ^①	7GN2084P	7GN2085P	
		25	30	7GN2582P	7GN2586P	7GN2593P ^②	7GN2583P	7GN2587P ^①	—	7GN2584P	7GN2585P ^①	
	90x90	32	40	7GN3282P	7GN3286P	7GN3293P	7GN3283P	7GN3287P	7GN3294P ^①	7GN3284P	7GN3285P	
		110x110	40	50	7GN4082P	7GN4086P	7GN4093P	7GN4083P	7GN4087P	7GN4094P ^③	7GN4084P	7GN4085P
		125x175	63	60	7GN6382P	7GN6386P	7GN6393P ^③	7GN6383P	7GN6387P	7GN6394P ^③	7GN6384P	7GN6385P ^③
180x254	125	130	7GN12582P	7GN12586P	—	7GN12583P	7GN12587P	—	7GN12584P	—		
GX...	90x90	16	12	GX1682P	GX1686P	GX1693P	GX1683P	GX1687P	GX1694P ^②	GX1684P	GX1685P	
		20	15	GX2082P	GX2086P	GX2093P	GX2083P	GX2087P	GX2094P ^②	GX2084P	GX2085P	
	110x110	32	32	GX3282P	GX3286P	—	GX3283P	GX3287P	—	GX3284P	—	
		40	40	GX4082P	GX4086P	—	GX4083P	GX4087P	—	GX4084P	—	
GN...	250x316	200	200	GN20082L	GN20086L	GN20093L	GN20083L	GN20087L	GN20094L	GN20084L	GN20085L	
		315	255	GN31582L	GN31586L	GN31593L	GN31583L	GN31587L	GN31594L	GN31584L	GN31585L	

- ① Enclosure size 90x90mm.
- ② Enclosure size 110x110mm.
- ③ Enclosure size 180x254mm.

Technical characteristics

Series	Rated thermal current I _{th}	UL/CSA general use	UL/CSA horsepower ratings					Max. IEC AC23 power 1 phase	Max. IEC AC23 power 3 phases
			1 phase		3 phases				
			120V [HP]	240V [HP]	240V [HP]	480V [HP]	600V [HP]		
7GN12...	16	15	0.5	1	3	—	—	1.7	5.5
7GN20...	20	20	0.75	2	3	7.5	10	2.5	7.5
7GN25...	25	30	1.5	3	5	10	15	3.7	11
7GN32...	32	40	2	5	10	15	15	4	15
7GN40...	40	50	2	5	10	20	20	6	18.5
7GN63...	63	60	3	10	15	25	25	7.5	30
7GN125...	125	130	5	15	25	50	40	11	45

Series	Rated thermal current I _{th}	UL/CSA general use	UL/CSA horsepower ratings					Max. IEC AC23 power 1 phase	Max. IEC AC23 power 3 phases
			1 phase		3 phases				
			120V [HP]	240V [HP]	240V [HP]	480V [HP]	600V [HP]		
GX16...	16	12	0.75	1	3	5	5	1.8	6.5
GX20...	20	15	0.75	1.5	3	5	5	2.2	7.5
GX32...	32	32	1.5	3	7.5	15	15	3.5	15
GX40...	40	40	2	5	10	15	15	5.2	18.5
GN200	200	200	15	30	50	100	75	—	47
GN315	315	255	15	30	50	100	75	37	110

STARTING WITH 0

Front mounting with black handle (U)



WIRING DIAGRAMS				107	123	135	108	124	136	109	110
Poles				1	2	3	1	2	3	1	1
Series	Front plate size	Rated thermal current I _{th}	UL/CSA general use								
	[mm]	[A]	[A]								
GF...	□30	10	10	GF10107U	GF10123U	GF10135U	GF10108U	GF10124U	GF10136U	GF10109U	GF10110U
	□48	20	15	GF20107U	GF20123U	GF20135U	GF20108U	GF20124U	GF20136U	GF20109U	GF20110U
7GN...	□65	16	15	7GN12107U	7GN12123U	7GN12135U	7GN12108U	7GN12124U	7GN12136U	7GN12109U	7GN12110U
		20	20	7GN20107U	7GN20123U	7GN20135U	7GN20108U	7GN20124U	7GN20136U	7GN20109U	7GN20110U
		25	30	7GN25107U	7GN25123U	7GN25135U	7GN25108U	7GN25124U	7GN25136U	7GN25109U	7GN25110U
		32	40	7GN32107U	7GN32123U	7GN32135U	7GN32108U	7GN32124U	7GN32136U	7GN32109U	7GN32110U
		40	50	7GN40107U	7GN40123U	7GN40135U	7GN40108U	7GN40124U	7GN40136U	7GN40109U	7GN40110U
□90	63	60	7GN63107U	7GN63123U	7GN63135U	7GN63108U	7GN63124U	7GN63136U	7GN63109U	7GN63110U	
	125	130	7GN125107U	7GN125123U	7GN125135U	7GN125108U	7GN125124U	7GN125136U	7GN125109U	7GN125110U	
GX...	□48	16	12	GX16107U	GX16123U	GX16135U	GX16108U	GX16124U	GX16136U	GX16109U	GX16110U
		20	15	GX20107U	GX20123U	GX20135U	GX20108U	GX20124U	GX20136U	GX20109U	GX20110U
	□65	32	32	GX32107U	GX32123U	GX32135U	GX32108U	GX32124U	GX32136U	GX32109U	GX32110U
		40	40	GX40107U	GX40123U	GX40135U	GX40108U	GX40124U	GX40136U	GX40109U	GX40110U
GN...	□132	200	200	GN200107U	GN200123U	GN200135U	GN200108U	GN200124U	GN200136U	GN200109U	GN200110U
		315	255	GN315107U	GN315123U	GN315135U	GN315108U	GN315124U	GN315136U	GN315109U	GN315110U

❶ Front plate for GF..., 7GN12... to 7GN63..., GX..., GN...

❷ Front plate for 7GN125...

WIRING DIAGRAMS

107-123-135

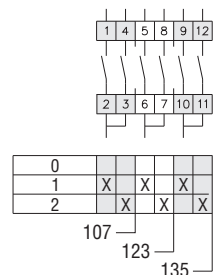

108-124-136

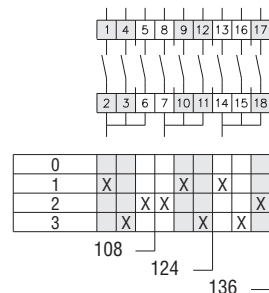

109

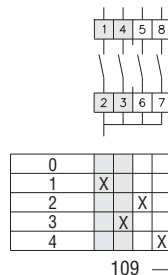

110

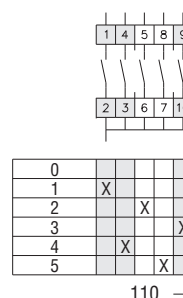

STARTING WITH 0



Snap on front mounting with black handle for hole Ø22mm fixing (U47) ❶

WIRING DIAGRAMS				107	123	135	108	124	136	109	110	
Poles				1	2	3	1	2	3	1	1	
Series	Front plate size	Rated thermal current I _{th}	UL/CSA general use									
	[mm]			[A]	[A]							
GF...	□30	10	10	GF10107U47	GF10123U47	GF10135U47	GF10108U47	GF10124U47	GF10136U47	GF10109U47	GF10110U47	
	□48	20	15	GF20107U47	GF20123U47	GF20135U47	GF20108U47	GF20124U47	GF20136U47	GF20109U47	GF20110U47	
7GN...	□48	16	15	7GN12107U47	7GN12123U47	7GN12135U47	7GN12108U47	7GN12124U47	7GN12136U47	7GN12109U47	7GN12110U47	
		20	20	7GN20107U47	7GN20123U47	7GN20135U47	7GN20108U47	7GN20124U47	7GN20136U47	7GN20109U47	7GN20110U47	
		25	30	7GN25107U47	7GN25123U47	7GN25135U47	7GN25108U47	7GN25124U47	7GN25136U47	7GN25109U47	7GN25110U47	
GX...	□48	16	12	GX16107U47	GX16123U47	GX16135U47	GX16108U47	GX16124U47	GX16136U47	GX16109U47	GX16110U47	
		20	15	GX20107U47	GX20123U47	GX20135U47	GX20108U47	GX20124U47	GX20136U47	GX20109U47	GX20110U47	

❶ For key operation version replace U47 with U29D (e.g. GF20107U29D).

Technical characteristics

Series	Rated thermal current I _{th}	UL/CSA general use	UL/CSA horsepower ratings					Max. IEC AC23 power 1 phase	Max. IEC AC23 power 3 phases
			1 phase		3 phases				
			120V [HP]	240V [HP]	240V [HP]	480V [HP]	600V [HP]		
GF10...	10	10	—	0.75	2	—	—	0.75	3
GF20...	20	15	—	1	3	—	—	2	7.5
7GN12...	16	15	0.5	1	3	—	—	1.7	5.5
7GN20...	20	20	0.75	2	3	7.5	10	2.5	7.5
7GN25...	25	30	1.5	3	5	10	15	3.7	11
7GN32...	32	40	2	5	10	15	15	4	15
7GN40...	40	50	2	5	10	20	20	6	18.5
7GN63...	63	60	3	10	15	25	25	7.5	30
7GN125...	125	130	5	15	25	50	40	11	45

Series	Rated thermal current I _{th}	UL/CSA general use	UL/CSA horsepower ratings					Max. IEC AC23 power 1 phase	Max. IEC AC23 power 3 phases
			1 phase		3 phases				
			120V [HP]	240V [HP]	240V [HP]	480V [HP]	600V [HP]		
GX16...	16	12	0.75	1	3	5	5	1.8	6.5
GX20...	20	15	0.75	1.5	3	5	5	2.2	7.5
GX32...	32	32	1.5	3	7.5	15	15	3.5	15
GX40...	40	40	2	5	10	15	15	5.2	18.5
GN200	200	200	15	30	50	100	75	—	47
GN315	315	255	15	30	50	100	75	37	110

STARTING WITH 0

Rear mounting with black handle (0)



WIRING DIAGRAMS				107	123	135	108	124	136	109	110
Poles				1	2	3	1	2	3	1	1
Series	Front plate size	Rated thermal current Ith	UL/CSA general use								
	[mm]	[A]	[A]								
GF...	□48	20	15	GF201070	GF201230	GF201350	GF201080	GF201240	GF201360	GF201090	GF201100
7GN...	□48	16	15	7GN121070	7GN121230	7GN121350	7GN121080	7GN121240	7GN121360	7GN121090	7GN121100
		20	20	7GN201070	7GN201230	7GN201350	7GN201080	7GN201240	7GN201360	7GN201090	7GN201100
		25	30	7GN251070	7GN251230	7GN251350	7GN251080	7GN251240	7GN251360	7GN251090	7GN251100
	□65	32	40	7GN321070	7GN321230	7GN321350	7GN321080	7GN321240	7GN321360	7GN321090	7GN321100
		40	50	7GN401070	7GN401230	7GN401350	7GN401080	7GN401240	7GN401360	7GN401090	7GN401100
	63	60	7GN631070	7GN631230	7GN631350	7GN631080	7GN631240	7GN631360	7GN631090	7GN631100	
GX...	□48	16	12	GX161070	GX161230	GX161350	GX161080	GX161240	GX161360	GX161090	GX161100
		20	15	GX201070	GX201230	GX201350	GX201080	GX201240	GX201360	GX201090	GX201100
	□65	32	32	GX321070	GX321230	GX321350	GX321080	GX321240	GX321360	GX321090	GX321100
	40	40	GX401070	GX401230	GX401350	GX401080	GX401240	GX401360	GX401090	GX401100	
GN...	□132	200	200	GN2001070	GN2001230	GN2001350	GN2001080	GN2001240	GN2001360	GN2001090	GN2001100
		315	255	GN3151070	GN3151230	GN3151350	GN3151080	GN3151240	GN3151360	GN3151090	GN3151100

Modular service cover for 35mm DIN rail mounting with black handle (048)Ⓢ



WIRING DIAGRAMS				107	123	135	108	124	136	109	110
Poles				1	2	3	1	2	3	1	1
Series	Front plate size	Rated thermal current Ith	UL/CSA general use								
	[mm]	[A]	[A]								
GF...	45x54	20	15	GF20107048	GF20123048	GF20135048	GF20108048	GF20124048	GF20136048	GF20109048	GF20110048
7GN...	45x54	16	15	7GN12107048	7GN12123048	7GN12135048	7GN12108048	7GN12124048	7GN12136048	7GN12109048	7GN12110048
		20	20	7GN20107048	7GN20123048	7GN20135048	7GN20108048	7GN20124048	7GN20136048	7GN20109048	7GN20110048
		25	30	7GN25107048	7GN25123048	7GN25135048	7GN25108048	7GN25124048	7GN25136048	7GN25109048	7GN25110048
GX...	45x54	16	12	GX16107048	GX16123048	GX16135048	GX16108048	GX16124048	GX16136048	GX16109048	GX16110048
		20	15	GX20107048	GX20123048	GX20135048	GX20108048	GX20124048	GX20136048	GX20109048	GX20110048

- ① Front plate for GF..., 7GN12... to 7GN63..., GX..., GN...
- ② Front plate for 7GN125...
- ③ For key operation version replace 048 with 049 (e.g. GF20107049).

WIRING DIAGRAMS

107-123-135

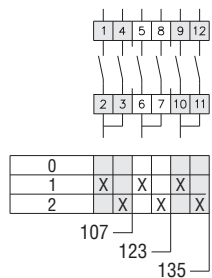

108-124-136

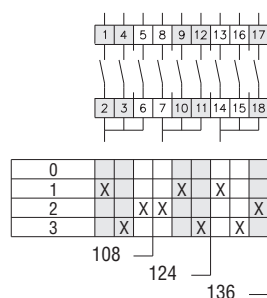

109

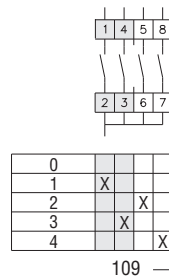

110

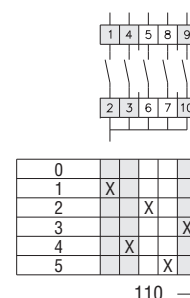

STARTING WITH 0

Cam switch in plastic enclosure with black handle (P)

Cam switch in metallic enclosure with black handle (L)



WIRING DIAGRAMS				107	123	135	108	124	136	109	110	
Poles				1	2	3	1	2	3	1	1	
Series	Enclosure size	Rated thermal current Ith	UL/CSA general use									
	[mm]	[A]	[A]									
7GN...	75x75	16	15	7GN12107P	7GN12123P	7GN12135P	7GN12108P	7GN12124P	7GN12136P ^⑤	7GN12109P	7GN12110P	
		20	20	7GN20107P	7GN20123P	7GN20135P	7GN20108P	7GN20124P	7GN20136P ^⑤	7GN20109P	7GN20110P	
		25	30	7GN25107P	7GN25123P	7GN25135P	7GN25108P	7GN25124P	7GN25136P ^④	7GN25109P	7GN25110P	
	90x90	32	40	7GN32107P	7GN32123P	7GN32135P	7GN32108P	7GN32124P	7GN32136P	7GN32109P	7GN32110P	
		110x110	40	50	7GN40107P	7GN40123P	7GN40135P	7GN40108P	7GN40124P	7GN40136P	7GN40109P	7GN40110P
		125x175	63	60	7GN63107P	7GN63123P	7GN63135P	7GN63108P	7GN63124P	7GN63136P ^⑤	7GN63109P	7GN63110P
180x254	125	130	7GN125107P	7GN125123P	7GN125135P	7GN125108P	7GN125124P	—	7GN125109P	7GN125110P		
GX...	90x90	16	12	GX16107P	GX16123P	GX16135P	GX16108P	GX16124P	GX16136P	GX16109P	GX16110P	
		20	15	GX20107P	GX20123P	GX20135P	GX20108P	GX20124P	GX20136P	GX20109P	GX20110P	
	110x110	32	32	GX32107P	GX32123P	GX32135P	GX32108P	GX32124P	—	GX32109P	GX32110P	
40		40	GX40107P	GX40123P	GX40135P	GX40108P	GX40124P	—	GX40109P	GX40110P		
GN...	250x316	200	200	GN200107L	GN200123L	GN200135L	GN200108L	GN200124L	GN200136L	GN200109L	GN200110L	
		315	255	GN315107L	GN315123L	GN315135L	GN315108L	GN315124L	GN315136L	GN315109L	GN315110L	

- ① Front plate for GF..., 7GN12... to 7GN63..., GX..., GN...
- ② Front plate for 7GN125...
- ③ Enclosure size 90x90mm.
- ④ Enclosure size 110x110mm.
- ⑤ Enclosure size 180x254mm.

Technical characteristics

Series	Rated thermal current Ith [A]	UL/CSA general use [A]	UL/CSA horsepower ratings					Max. IEC AC23 power 1 phase [kW] at 230V	Max. IEC AC23 power 3 phases [kW] at 400V
			1 phase		3 phases				
			120V [HP]	240V [HP]	240V [HP]	480V [HP]	600V [HP]		
GF20...	20	15	—	1	3	—	—	2	7.5
7GN12...	16	15	0.5	1	3	—	—	1.7	5.5
7GN20...	20	20	0.75	2	3	7.5	10	2.5	7.5
7GN25...	25	30	1.5	3	5	10	15	3.7	11
7GN32...	32	40	2	5	10	15	15	4	15
7GN40...	40	50	2	5	10	20	20	6	18.5
7GN63...	63	60	3	10	15	25	25	7.5	30
7GN125...	125	130	5	15	25	50	40	11	45

Series	Rated thermal current Ith [A]	UL/CSA general use [A]	UL/CSA horsepower ratings					Max. IEC AC23 power 1 phase [kW] at 230V	Max. IEC AC23 power 3 phases [kW] at 400V
			1 phase		3 phases				
			120V [HP]	240V [HP]	240V [HP]	480V [HP]	600V [HP]		
GX16...	16	12	0.75	1	3	5	5	1.8	6.5
GX20...	20	15	0.75	1.5	3	5	5	2.2	7.5
GX32...	32	32	1.5	3	7.5	15	15	3.5	15
GX40...	40	40	2	5	10	15	15	5.2	18.5
GN200	200	200	15	30	50	100	75	—	47
GN315	315	255	15	30	50	100	75	37	110

VOLTMETER AND AMMETER SWITCHES

Front mounting with black handle (U)



Type				Voltmeter switches			Ammeter switches		
WIRING DIAGRAMS				66	67	68	97	98	
Series	Front plate size	Rated thermal current I _{th}	UL/CSA general use						
				[mm]	[A]	[A]			
GF...	□30	10	10	GF1066U	GF1067U	GF1068U	GF1097U	GF1098U	
	□48	20	15	GF2066U	GF2067U	GF2068U	GF2097U	GF2098U	
7GN...	□48	16	15	7GN1266U	7GN1267U	7GN1268U	7GN1297U	7GN1298U	
		20	20	7GN2066U	7GN2067U	7GN2068U	7GN2097U	7GN2098U	
		25	30	7GN2566U	7GN2567U	7GN2568U	7GN2597U	7GN2598U	
	□65	32	40	7GN3266U	7GN3267U	7GN3268U	7GN3297U	7GN3298U	
40		50	7GN4066U	7GN4067U	7GN4068U	7GN4097U	7GN4098U		
GX...	□48	16	12	GX1666U	GX1667U	GX1668U	GX1697U	GX1698U	
		20	15	GX2066U	GX2067U	GX2068U	GX2097U	GX2098U	
	□65	32	32	GX3266U	GX3267U	GX3268U	GX3297U	GX3298U	
40		40	GX4066U	GX4067U	GX4068U	GX4097U	GX4098U		

Snap on front mounting with black handle for hole Ø22mm fixing (U47)Ⓢ



Type				Voltmeter switches			Ammeter switches		
WIRING DIAGRAMS				66	67	68	97	98	
Series	Front plate size	Rated thermal current I _{th}	UL/CSA general use						
				[mm]	[A]	[A]			
GF...	□30	10	10	GF1066U47	GF1067U47	GF1068U47	GF1097U47	GF1098U47	
	□48	20	15	GF2066U47	GF2067U47	GF2068U47	GF2097U47	GF2098U47	
7GN...	□48	16	15	7GN1266U47	7GN1267U47	7GN1268U47	7GN1297U47	7GN1298U47	
		20	20	7GN2066U47	7GN2067U47	7GN2068U47	7GN2097U47	7GN2098U47	
		25	30	7GN2566U47	7GN2567U47	7GN2568U47	7GN2597U47	7GN2598U47	
GX...	□48	16	12	GX1666U47	GX1667U47	GX1668U47	GX1697U47	GX1698U47	
		20	15	GX2066U47	GX2067U47	GX2068U47	GX2097U47	GX2098U47	

- ① Front plate for GF20..., 7GN..., GX..., GN...
- ② Front plate for GF10...
- ③ For key operation version replace U47 with U29D (e.g. GF2066U29D).

WIRING DIAGRAMS

66

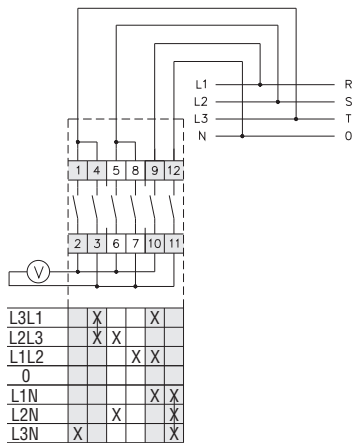

67

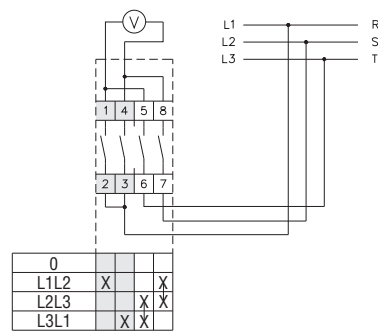

68

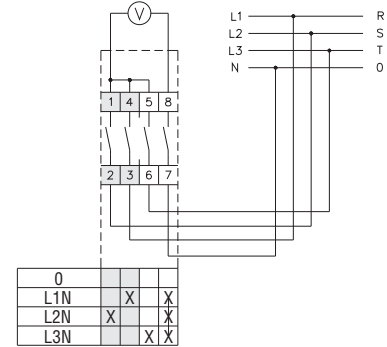

97

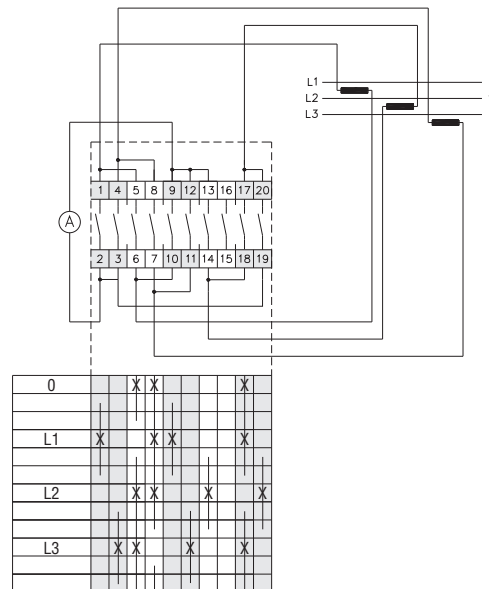
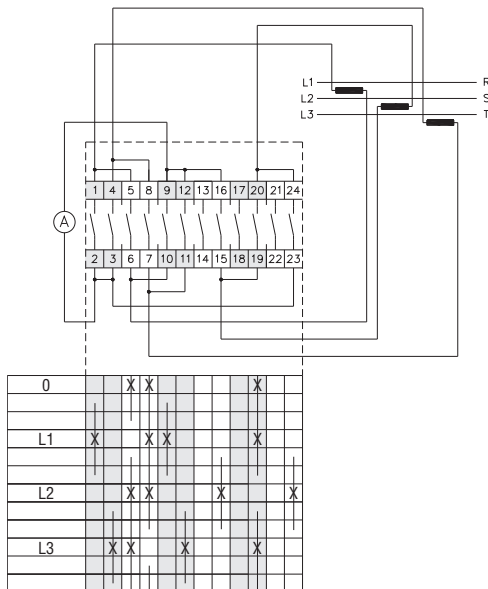

98

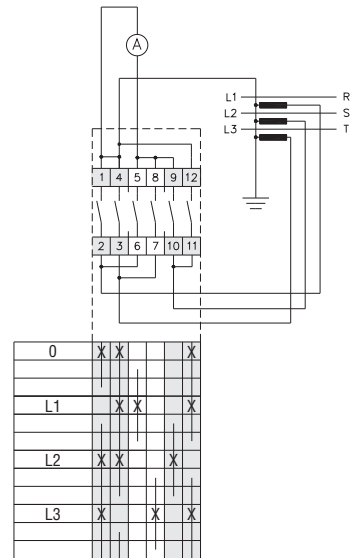

Technical characteristics

Series	Rated thermal current I _{th} [A]	UL/CSA general use [A]	UL/CSA horsepower ratings					Max. IEC AC23 power 1 phase [kW] at 230V	Max. IEC AC23 power 3 phases [kW] at 400V
			1 phase		3 phases				
	[A]	[A]	120V [HP]	240V [HP]	240V [HP]	480V [HP]	600V [HP]		
GF10...	10	10	—	0.75	2	—	—	0.75	3
GF20...	20	15	—	1	3	—	—	2	7.5
7GN12...	16	15	0.5	1	3	—	—	1.7	5.5
7GN20...	20	20	0.75	2	3	7.5	10	2.5	7.5
7GN25...	25	30	1.5	3	5	10	15	3.7	11
7GN32...	32	40	2	5	10	15	15	4	15
7GN40...	40	50	2	5	10	20	20	6	18.5

Series	Rated thermal current I _{th} [A]	UL/CSA general use [A]	UL/CSA horsepower ratings					Max. IEC AC23 power 1 phase [kW] at 230V	Max. IEC AC23 power 3 phases [kW] at 400V
			1 phase		3 phases				
	[A]	[A]	120V [HP]	240V [HP]	240V [HP]	480V [HP]	600V [HP]		
GX16...	16	12	0.75	1	3	5	5	1.8	6.5
GX20...	20	15	0.75	1.5	3	5	5	2.2	7.5
GX32...	32	32	1.5	3	7.5	15	15	3.5	15
GX40...	40	40	2	5	10	15	15	5.2	18.5

VOLTMETER AND AMMETER SWITCHES

Rear mounting with black handle (0)



Type				Voltmeter switches			Ammeter switches	
WIRING DIAGRAMS				66	67	68	97	98
Series	Front plate size	Rated thermal current I _{th}	UL/CSA general use					
	[mm]	[A]	[A]					
GF...	□48	20	15	GF20660	GF20670	GF20680	GF20970	GF20980
7GN...	□48	16	15	7GN12660	7GN12670	7GN12680	7GN12970	7GN12980
		20	20	7GN20660	7GN20670	7GN20680	7GN20970	7GN20980
		25	30	7GN25660	7GN25670	7GN25680	7GN25970	7GN25980
	□65	32	40	7GN32660	7GN32670	7GN32680	7GN32970	7GN32980
		40	50	7GN40660	7GN40670	7GN40680	7GN40970	7GN40980
GX...	□48	16	12	GX16660	GX16670	GX16680	GX16970	GX16980
		20	15	GX20660	GX20670	GX20680	GX20970	GX20980
	□65	32	32	GX32660	GX32670	GX32680	GX32970	GX32980
		40	40	GX40660	GX40670	GX40680	GX40970	GX40980

Modular service cover for 35mm DIN rail mounting with black handle (048)⓪



Type				Voltmeter switches			Ammeter switches	
WIRING DIAGRAMS				66	67	68	97	98
Series	Front plate size	Rated thermal current I _{th}	UL/CSA general use					
	[mm]	[A]	[A]					
GF...	□45X54	20	15	GF2066048	GF2067048	GF2068048	GF2097048	GF2098048
7GN...	□45X54	16	15	7GN1266048	7GN1267048	7GN1268048	7GN1297048	7GN1298048
		20	20	7GN2066048	7GN2067048	7GN2068048	7GN2097048	7GN2098048
		25	30	7GN2566048	7GN2567048	7GN2568048	7GN2597048	7GN2598048
GX...	□45X54	16	12	GX1666048	GX1667048	GX1668048	GX1697048	GX1698048
		20	15	GX2066048	GX2067048	GX2068048	GX2097048	GX2098048

⓪ For key operation version replace O48 with O49 (e.g. GF2066049).

WIRING DIAGRAMS

66

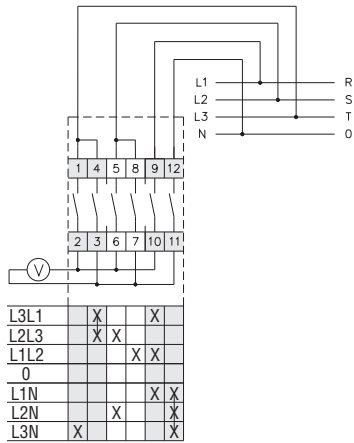

67

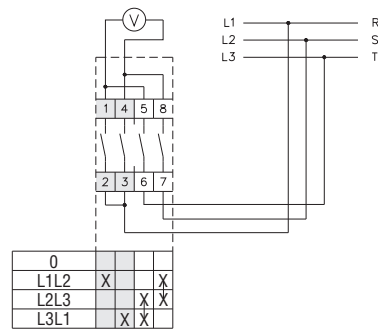

68

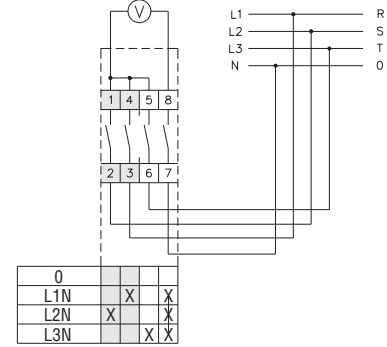

97

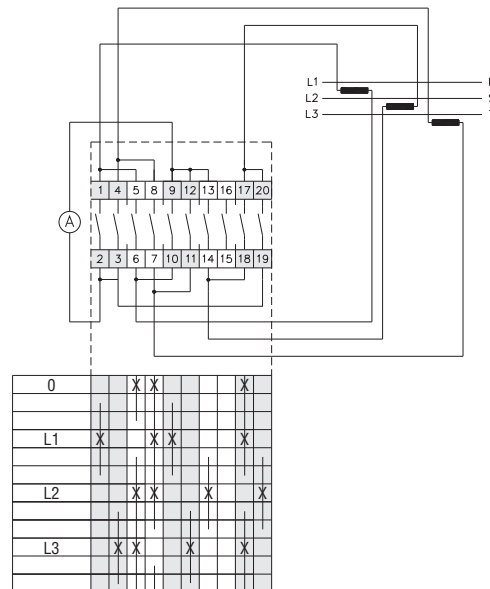
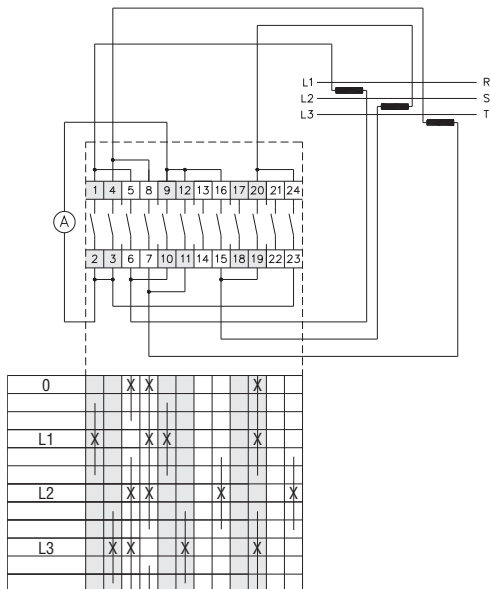

98

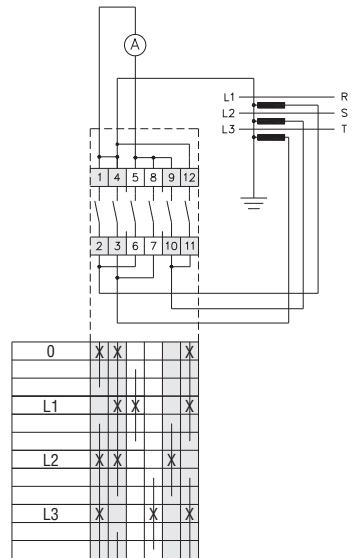

Technical characteristics

Series	Rated thermal current I _{th} [A]	UL/CSA general use [A]	UL/CSA horsepower ratings					Max. IEC AC23 power 1 phase [kW] at 230V	Max. IEC AC23 power 3 phases [kW] at 400V
			1 phase		3 phases				
			120V [HP]	240V [HP]	240V [HP]	480V [HP]	600V [HP]		
GF10...	10	10	—	0.75	2	—	—	0.75	3
GF20...	20	15	—	1	3	—	—	2	7.5
7GN12...	16	15	0.5	1	3	—	—	1.7	5.5
7GN20...	20	20	0.75	2	3	7.5	10	2.5	7.5
7GN25...	25	30	1.5	3	5	10	15	3.7	11
7GN32...	32	40	2	5	10	15	15	4	15
7GN40...	40	50	2	5	10	20	20	6	18.5

Series	Rated thermal current I _{th} [A]	UL/CSA general use [A]	UL/CSA horsepower ratings					Max. IEC AC23 power 1 phase [kW] at 230V	Max. IEC AC23 power 3 phases [kW] at 400V
			1 phase		3 phases				
			120V [HP]	240V [HP]	240V [HP]	480V [HP]	600V [HP]		
GX16...	16	12	0.75	1	3	5	5	1.8	6.5
GX20...	20	15	0.75	1.5	3	5	5	2.2	7.5
GX32...	32	32	1.5	3	7.5	15	15	3.5	15
GX40...	40	40	2	5	10	15	15	5.2	18.5

MOTOR REVERSING, STAR-DELTA, DAHLANDER MOTOR CONTROL, SEPARATE WINDINGS SWITCHES



Front mount with black handle (U)

Type				Motor reversing			Star-delta	Dahlander motor control			Separate windings
WIRING DIAGRAMS				25	11	26	12	13	19	20	53
Series	Front plate size	Rated thermal current I _{th}	UL/CSA general use								
	[mm]	[A]	[A]								
GF...	□30	10	10	GF1025U	GF1011U	GF1026U	GF1012U	GF1013U	GF1019U	GF1020U	GF1053U
	□48	20	15	GF2025U	GF2011U	GF2026U	GF2012U	GF2013U	GF2019U	GF2020U	GF2053U
7GN...	□48	16	15	7GN1225U	7GN1211U	7GN1226U	7GN1212U	7GN1213U	7GN1219U	7GN1220U	7GN1253U
		20	20	7GN2025U	7GN2011U	7GN2026U	7GN2012U	7GN2013U	7GN2019U	7GN2020U	7GN2053U
		25	30	7GN2525U	7GN2511U	7GN2526U	7GN2512U	7GN2513U	7GN2519U	7GN2520U	7GN2553U
	□65	32	40	7GN3225U	7GN3211U	7GN3226U	7GN3212U	7GN3213U	7GN3219U	7GN3220U	7GN3253U
		40	50	7GN4025U	7GN4011U	7GN4026U	7GN4012U	7GN4013U	7GN4019U	7GN4020U	7GN4053U
		63	60	7GN6325U	7GN6311U	7GN6326U	7GN6312U	7GN6313U	7GN6319U	7GN6320U	7GN6353U
□90	125	130	7GN12525U	7GN12511U	7GN12526U	7GN12512U	7GN12513U	7GN12519U	7GN12520U	7GN12553U	
GX...	□48	16	12	GX1625U	GX1611U	GX1626U	GX1612U	GX1613U	GX1619U	GX1620U	GX1653U
		20	15	GX2025U	GX2011U	GX2026U	GX2012U	GX2013U	GX2019U	GX2020U	GX2053U
	□65	32	32	GX3225U	GX3211U	GX3226U	GX3212U	GX3213U	GX3219U	GX3220U	GX3253U
		40	40	GX4025U	GX4011U	GX4026U	GX4012U	GX4013U	GX4019U	GX4020U	GX4053U
GN...	□132	200	200	GN20025U	GN20011U	GN20026U	GN20012U	GN20013U	GN20019U	GN20020U	GN20053U
		315	255	GN31525U	GN31511U	GN31526U	GN31512U	GN31513U	GN31519U	GN31520U	GN31553U



Front mounting with red/yellow handle padlockable in 0 and protection covers (U25)Ⓢ

Type				Motor reversing			Star-delta	Dahlander motor control			Separate windings
WIRING DIAGRAMS				25	11	26	12	13	19	20	53
Series	Front plate size	Rated thermal current I _{th}	UL/CSA general use								
	[mm]	[A]	[A]								
GF...	□48	20	15	GF2025U25	GF2011U25	GF2026U25	GF2012U25	GF2013U25	GF2019U25	GF2020U25	GF2053U25
GX...	□48	16	12	GX1625U25	GX1611U25	GX1626U25	GX1612U25	GX1613U25	GX1619U25	GX1620U25	GX1653U25
		20	15	GX2025U25	GX2011U25	GX2026U25	GX2012U25	GX2013U25	GX2019U25	GX2020U25	GX2053U25
	□65	32	32	GX3225U25	GX3211U25	GX3226U25	GX3212U25	GX3213U25	GX3219U25	GX3220U25	GX3253U25
		40	40	GX4025U25	GX4011U25	GX4026U25	GX4012U25	GX4013U25	GX4019U25	GX4020U25	GX4053U25

① Front plate for GF20..., 7GN..., GX...

② Front plate for GF10..., GN...

Ⓢ For version not padlockable and without protection covers replace U25 with U24 (e.g. GF1025U24).

11 Rotary cam switches

Motor starting

WIRING DIAGRAMS

25

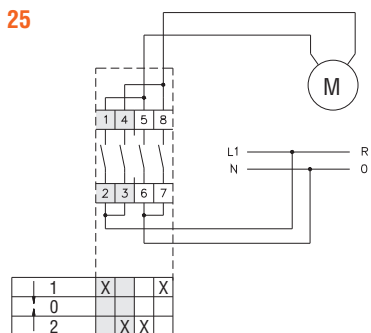

11

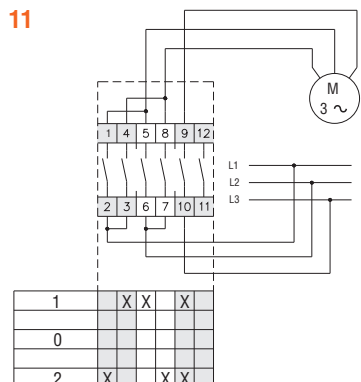

26

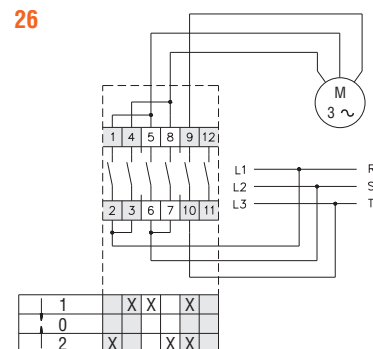

12

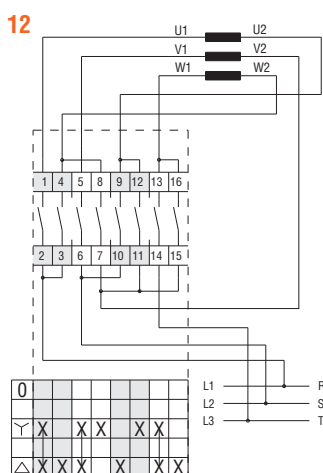

13

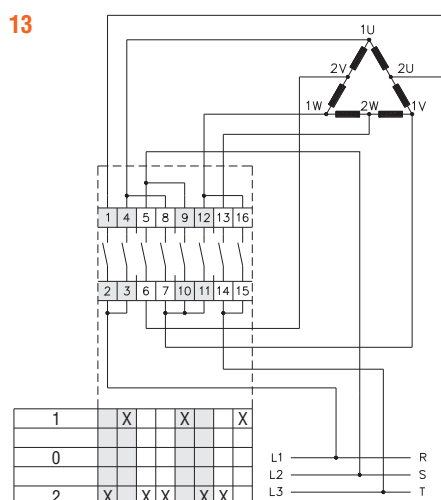

19

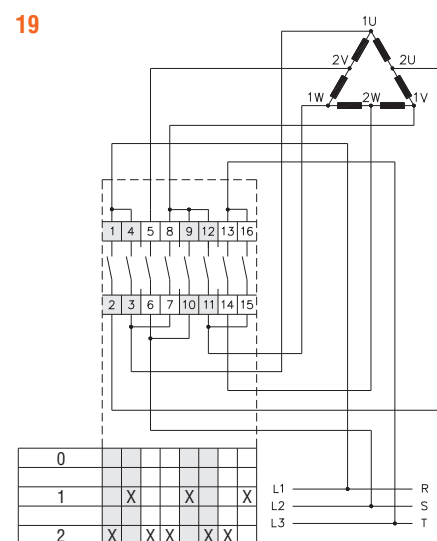

20

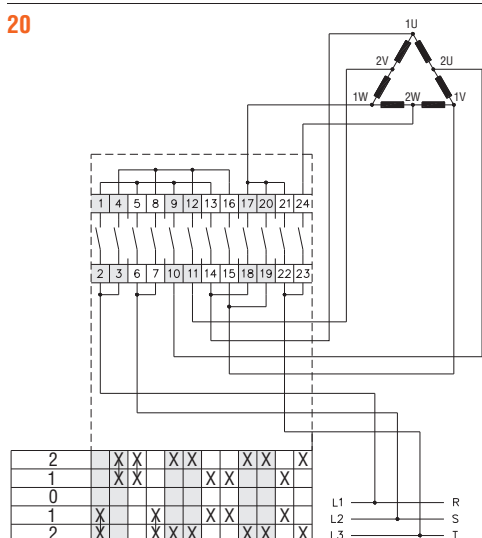

53

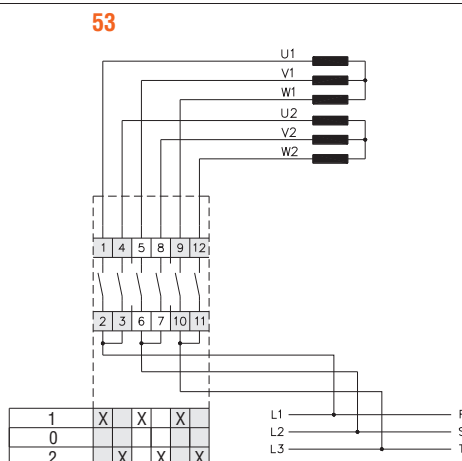

Technical characteristics

Series	Rated thermal current lth [A]	UL/CSA general use [A]	UL/CSA horsepower ratings					Max. IEC AC23 power 1 phase [kW] at 230V	Max. IEC AC23 power 3 phases [kW] at 400V
			1 phase		3 phases				
			120V [HP]	240V [HP]	240V [HP]	480V [HP]	600V [HP]		
GF10...	10	10	—	0.75	2	—	—	0.75	3
GF20...	20	15	—	1	3	—	—	2	7.5
7GN12...	16	15	0.5	1	3	—	—	1.7	5.5
7GN20...	20	20	0.75	2	3	7.5	10	2.5	7.5
7GN25...	25	30	1.5	3	5	10	15	3.7	11
7GN32...	32	40	2	5	10	15	15	4	15
7GN40...	40	50	2	5	10	20	20	6	18.5
7GN63...	63	60	3	10	15	25	25	7.5	30
7GN125...	125	130	5	15	25	50	40	11	45

Series	Rated thermal current lth [A]	UL/CSA general use [A]	UL/CSA horsepower ratings					Max. IEC AC23 power 1 phase [kW] at 230V	Max. IEC AC23 power 3 phases [kW] at 400V
			1 phase		3 phases				
			120V [HP]	240V [HP]	240V [HP]	480V [HP]	600V [HP]		
GX16...	16	12	0.75	1	3	5	5	1.8	6.5
GX20...	20	15	0.75	1.5	3	5	5	2.2	7.5
GX32...	32	32	1.5	3	7.5	15	15	3.5	15
GX40...	40	40	2	5	10	15	15	5.2	18.5
GN200	200	200	15	30	50	100	75	—	47
GN315	315	255	15	30	50	100	75	37	110

11 Rotary cam switches

Motor starting

MOTOR REVERSING, STAR-DELTA, DAHLANDER MOTOR CONTROL, SEPARATE WINDINGS SWITCHES



Front mounting with red/yellow handle padlockable in 0 and protection covers (U65)

Type				Motor reversing			Star-delta	Dahlander motor control			Separate windings
WIRING DIAGRAMS				25	11	26	12	13	19	20	53
Series	Front plate size	Rated thermal current I _{th}	UL/CSA general use								
	[mm]	[A]	[A]								
7GN...	□65	16	15	7GN1225U65	7GN1211U65	7GN1226U65	7GN1212U65	7GN1213U65	7GN1219U65	7GN1220U65	7GN1253U65
		20	20	7GN2025U65	7GN2011U65	7GN2026U65	7GN2012U65	7GN2013U65	7GN2019U65	7GN2020U65	7GN2053U65
		25	30	7GN2525U65	7GN2511U65	7GN2526U65	7GN2512U65	7GN2513U65	7GN2519U65	7GN2520U65	7GN2553U65
		32	40	7GN3225U65	7GN3211U65	7GN3226U65	7GN3212U65	7GN3213U65	7GN3219U65	7GN3220U65	7GN3253U65
		40	50	7GN4025U65	7GN4011U65	7GN4026U65	7GN4012U65	7GN4013U65	7GN4019U65	7GN4020U65	7GN4053U65
		63	60	7GN6325U65	7GN6311U65	7GN6326U65	7GN6312U65	7GN6313U65	7GN6319U65	7GN6320U65	7GN6353U65
	□90	125	130	7GN12525U65	7GN12511U65	7GN12526U65	7GN12512U65	7GN12513U65	7GN12519U65	7GN12520U65	7GN12553U65

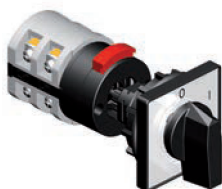

Snap on front mounting with black handle for hole Ø22mm fixing (U47) ①

Type				Motor reversing			Star-delta	Dahlander motor control			Separate windings
WIRING DIAGRAMS				25	11	26	12	13	19	20	53
Series	Front plate size	Rated thermal current I _{th}	UL/CSA general use								
	[mm]	[A]	[A]								
GF...	□30	10	10	GF1025U47	GF1011U47	GF1026U47	GF1012U47	GF1013U47	GF1019U47	GF1020U47	GF1053U47
	□48	20	15	GF2025U47	GF2011U47	GF2026U47	GF2012U47	GF2013U47	GF2019U47	GF2020U47	GF2053U47
7GN...	□48	16	15	7GN1225U47	7GN1211U47	7GN1226U47	7GN1212U47	7GN1213U47	7GN1219U47	7GN1220U47	7GN1253U47
		20	20	7GN2025U47	7GN2011U47	7GN2026U47	7GN2012U47	7GN2013U47	7GN2019U47	7GN2020U47	7GN2053U47
		25	30	7GN2525U47	7GN2511U47	7GN2526U47	7GN2512U47	7GN2513U47	7GN2519U47	7GN2520U47	7GN2553U47
GX...	□48	16	12	GX1625U47	GX1611U47	GX1626U47	GX1612U47	GX1613U47	GX1619U47	GX1620U47	GX1653U47
		20	15	GX2025U47	GX2011U47	GX2026U47	GX2012U47	GX2013U47	GX2019U47	GX2020U47	GX2053U47

① For key operation version replace U47 with U29D (e.g. GF2025U29D).

② Front plate for GF20..., 7GN..., GX...

③ Front plate for GF10..., GN...

WIRING DIAGRAMS

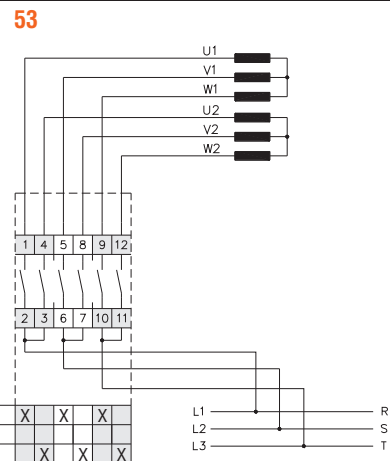
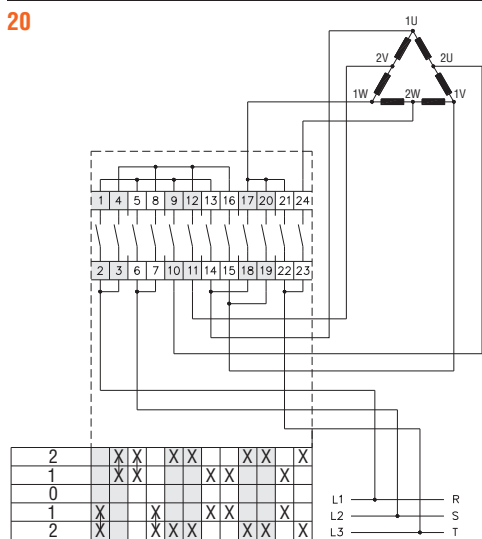
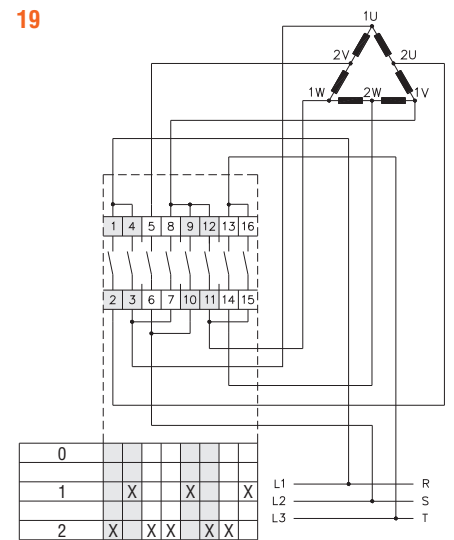
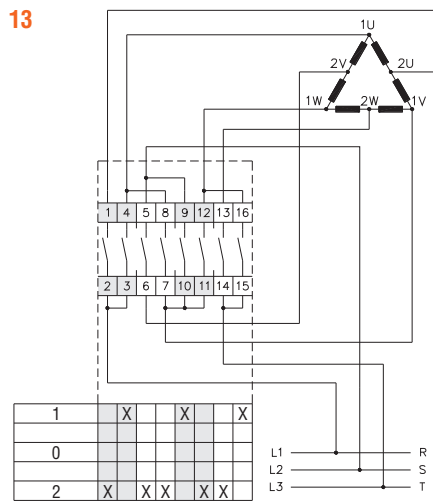
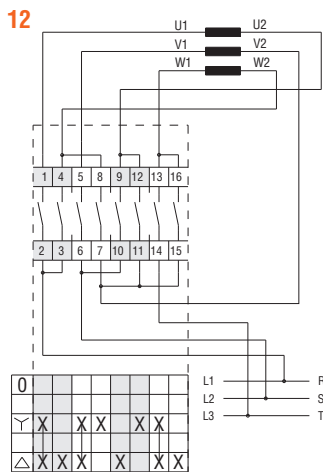
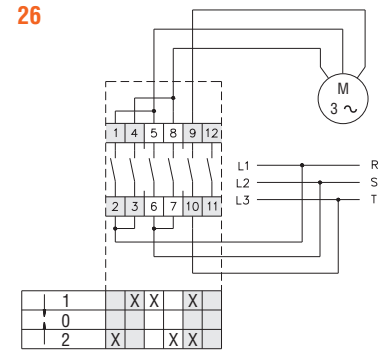
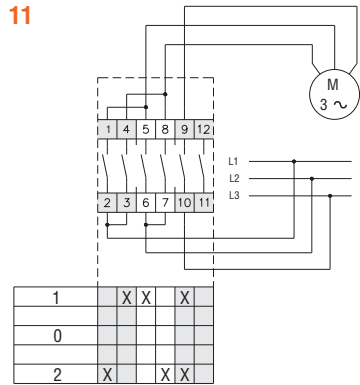
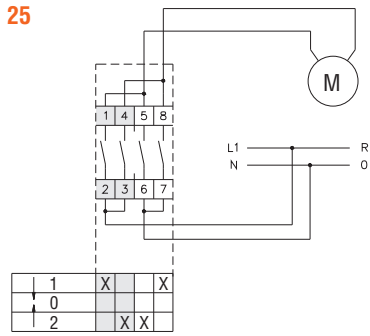

Technical characteristics

Series	Rated thermal current Ith [A]	UL/CSA general use [A]	UL/CSA horsepower ratings					Max. IEC AC23 power 1 phase [kW] at 230V	Max. IEC AC23 power 3 phases [kW] at 400V
			1 phase		3 phases				
			120V [HP]	240V [HP]	240V [HP]	480V [HP]	600V [HP]		
GF10...	10	10	—	0.75	2	—	—	0.75	3
GF20...	20	15	—	1	3	—	—	2	7.5
7GN12...	16	15	0.5	1	3	—	—	1.7	5.5
7GN20...	20	20	0.75	2	3	7.5	10	2.5	7.5
7GN25...	25	30	1.5	3	5	10	15	3.7	11
7GN32...	32	40	2	5	10	15	15	4	15
7GN40...	40	50	2	5	10	20	20	6	18.5
7GN63...	63	60	3	10	15	25	25	7.5	30
7GN125...	125	130	5	15	25	50	40	11	45

Series	Rated thermal current Ith [A]	UL/CSA general use [A]	UL/CSA horsepower ratings					Max. IEC AC23 power 1 phase [kW] at 230V	Max. IEC AC23 power 3 phases [kW] at 400V
			1 phase		3 phases				
			120V [HP]	240V [HP]	240V [HP]	480V [HP]	600V [HP]		
GX16...	16	12	0.75	1	3	5	5	1.8	6.5
GX20...	20	15	0.75	1.5	3	5	5	2.2	7.5

MOTOR REVERSING, STAR-DELTA, DAHLANDER MOTOR CONTROL, SEPARATE WINDINGS SWITCHES



Rear mounting with black handle (0)

Type				Motor reversing			Star-delta	Dahlander motor control			Separate windings
WIRING DIAGRAMS				25	11	26	12	13	19	20	53
Series	Front plate size	Rated thermal current I _{th}	UL/CSA general use								
	[mm]	[A]	[A]								
GF...	□48	20	15	GF20250	GF20110	GF20260	GF20120	GF20130	GF20190	GF20200	GF20530
7GN...	□48	16	15	7GN12250	7GN12110	7GN12260	7GN12120	7GN12130	7GN12190	7GN12200	7GN12530
		20	20	7GN20250	7GN20110	7GN20260	7GN20120	7GN20130	7GN20190	7GN20200	7GN20530
		25	30	7GN25250	7GN25110	7GN25260	7GN25120	7GN25130	7GN25190	7GN25200	7GN25530
	□65	32	40	7GN32250	7GN32110	7GN32260	7GN32120	7GN32130	7GN32190	7GN32200	7GN32530
		40	50	7GN40250	7GN40110	7GN40260	7GN40120	7GN40130	7GN40190	7GN40200	7GN40530
□90	125	130	7GN125250	7GN125110	7GN125260	7GN125120	7GN125130	7GN125190	7GN125200	7GN125530	
GX...	□48	16	12	GX16250	GX16110	GX16260	GX16120	GX16130	GX16190	GX16200	GX16530
		20	15	GX20250	GX20110	GX20260	GX20120	GX20130	GX20190	GX20200	GX20530
	□65	32	32	GX32250	GX32110	GX32260	GX32120	GX32130	GX32190	GX32200	GX32530
		40	40	GX40250	GX40110	GX40260	GX40120	GX40130	GX40190	GX40200	GX40530
GN...	□132	200	200	GN200250	GN200110	GN200260	GN200120	GN200130	GN200190	GN200200	GN200530
		315	255	GN315250	GN315110	GN315260	GN315120	GN315130	GN315190	GN315200	GN315530



Modular service cover for 35mm DIN rail mounting with black handle (048)Ⓢ

Type				Motor reversing			Star-delta	Dahlander motor control			Separate windings
WIRING DIAGRAMS				25	11	26	12	13	19	20	53
Series	Front plate size	Rated thermal current I _{th}	UL/CSA general use								
	[mm]	[A]	[A]								
GF...	45x54	20	15	GF2025048	GF2011048	GF2026048	GF2012048	GF2013048	GF2019048	GF2020048	GF2053048
7GN...	45x54	16	15	7GN1225048	7GN1211048	7GN1226048	7GN1212048	7GN1213048	7GN1219048	7GN1220048	7GN1253048
		20	20	7GN2025048	7GN2011048	7GN2026048	7GN2012048	7GN2013048	7GN2019048	7GN2020048	7GN2053048
		25	30	7GN2525048	7GN2511048	7GN2526048	7GN2512048	7GN2513048	7GN2519048	7GN2520048	7GN2553048
GX...	45x54	16	12	GX1625048	GX1611048	GX1626048	GX1612048	GX1613048	GX1619048	GX1620048	GX1653048
		20	15	GX2025048	GX2011048	GX2026048	GX2012048	GX2013048	GX2019048	GX2020048	GX2053048

① Front plate for GF20..., 7GN..., GX...

② Front plate for GF10..., GN...

Ⓢ For key operation version replace 048 with 049 (e.g. GF2025049).

WIRING DIAGRAMS

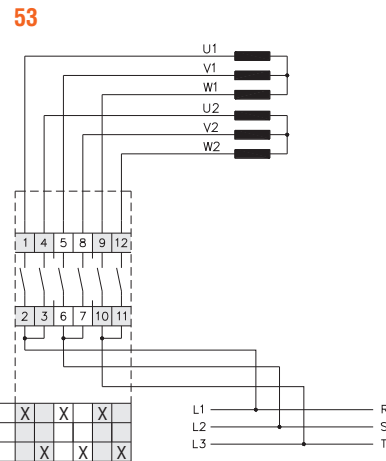
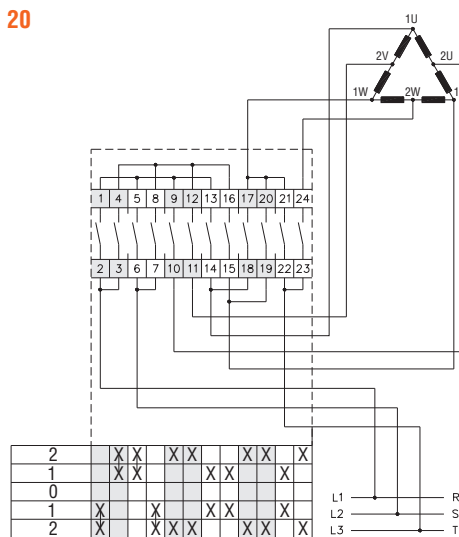
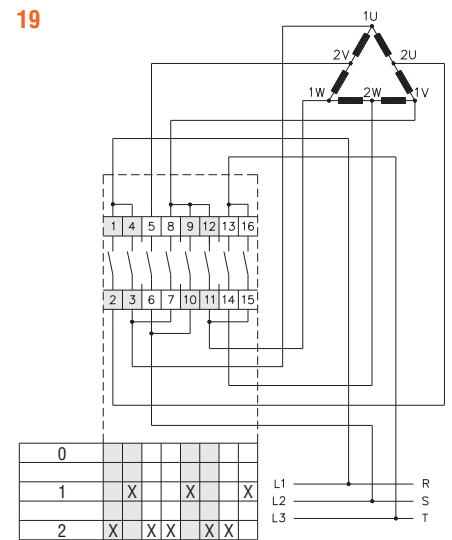
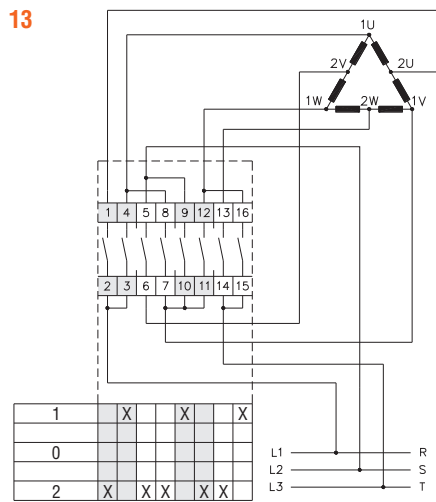
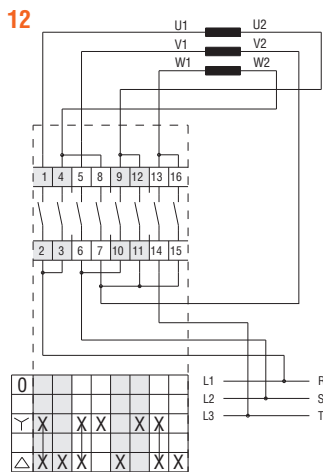
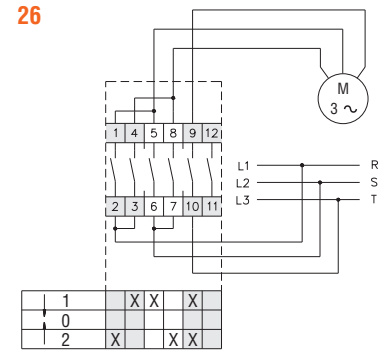
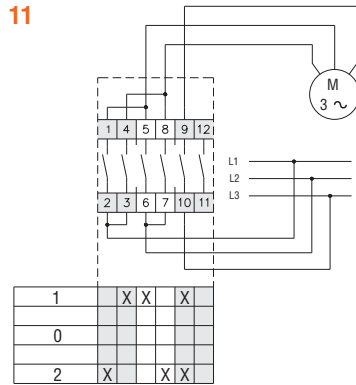
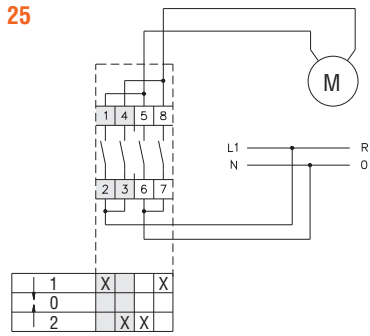

Technical characteristics

Series	Rated thermal current Ith [A]	UL/CSA general use [A]	UL/CSA horsepower ratings					Max. IEC AC23 power 1 phase [kW] at 230V	Max. IEC AC23 power 3 phases [kW] at 400V
			1 phase		3 phases				
			120V [HP]	240V [HP]	240V [HP]	480V [HP]	600V [HP]		
GF20...	20	15	—	1	3	—	2	7.5	
7GN12...	16	15	0.5	1	3	—	1.7	5.5	
7GN20...	20	20	0.75	2	3	7.5	2.5	7.5	
7GN25...	25	30	1.5	3	5	10	3.7	11	
7GN32...	32	40	2	5	10	15	4	15	
7GN40...	40	50	2	5	10	20	6	18.5	
7GN63...	63	60	3	10	15	25	7.5	30	
7GN125...	125	130	5	15	25	50	11	45	

Series	Rated thermal current Ith [A]	UL/CSA general use [A]	UL/CSA horsepower ratings					Max. IEC AC23 power 1 phase [kW] at 230V	Max. IEC AC23 power 3 phases [kW] at 400V
			1 phase		3 phases				
			120V [HP]	240V [HP]	240V [HP]	480V [HP]	600V [HP]		
GX16...	16	12	0.75	1	3	5	5	1.8	6.5
GX20...	20	15	0.75	1.5	3	5	5	2.2	7.5
GX32...	32	32	1.5	3	7.5	15	15	3.5	15
GX40...	40	40	2	5	10	15	15	5.2	18.5
GN200	200	200	15	30	50	100	75	—	47
GN315	315	255	15	30	50	100	75	37	110

11 Rotary cam switches

Motor starting

MOTOR REVERSING, STAR-DELTA, DAHLANDER MOTOR CONTROL, SEPARATE WINDINGS SWITCHES

Rear mounting with red/yellow handle padlockable in 0, door coupling and protection covers **(088)**

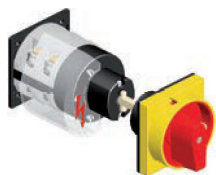

Type				Motor reversing			Star-delta	Dahlander motor control			Separate windings
WIRING DIAGRAMS				25	11	26	12	13	19	20	53
Series	Front plate size	Rated thermal current I _{th}	UL/CSA general use								
	[mm]	[A]	[A]								
GF...	□48	20	15	GF2025088	GF2011088	GF2026088	GF2012088	GF2013088	GF2019088	GF2020088	GF2053088
GX...	□48	16	12	GX1625088	GX1611088	GX1626088	GX1612088	GX1613088	GX1619088	GX1620088	GX1653088
		20	15	GX2025088	GX2011088	GX2026088	GX2012088	GX2013088	GX2019088	GX2020088	GX2053088
	□65	32	32	GX3225088	GX3211088	GX3226088	GX3212088	GX3213088	GX3219088	GX3220088	GX3253088
		40	40	GX4025088	GX4011088	GX4026088	GX4012088	GX4013088	GX4019088	GX4020088	GX4053088

Rear mounting with red/yellow handle padlockable in 0, door coupling and protection covers **(098)**



Type				Motor reversing			Star-delta	Dahlander motor control			Separate windings
WIRING DIAGRAMS				25	11	26	12	13	19	20	53
Series	Front plate size	Rated thermal current I _{th}	UL/CSA general use								
	[mm]	[A]	[A]								
7GN...	□65	16	15	7GN1225098	7GN1211098	7GN1226098	7GN1212098	7GN1213098	7GN1219098	7GN1220098	7GN1253098
		20	20	7GN2025098	7GN2011098	7GN2026098	7GN2012098	7GN2013098	7GN2019098	7GN2020098	7GN2053098
		25	30	7GN2525098	7GN2511098	7GN2526098	7GN2512098	7GN2513098	7GN2519098	7GN2520098	7GN2553098
		32	40	7GN3225098	7GN3211098	7GN3226098	7GN3212098	7GN3213098	7GN3219098	7GN3220098	7GN3253098
		40	50	7GN4025098	7GN4011098	7GN4026098	7GN4012098	7GN4013098	7GN4019098	7GN4020098	7GN4053098

WIRING DIAGRAMS

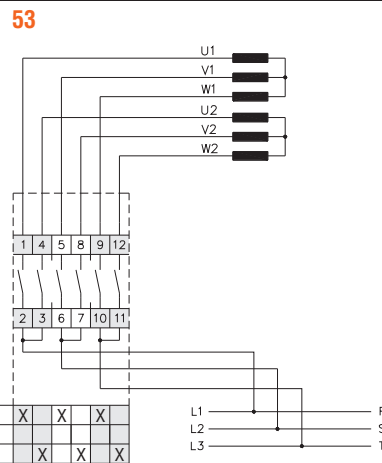
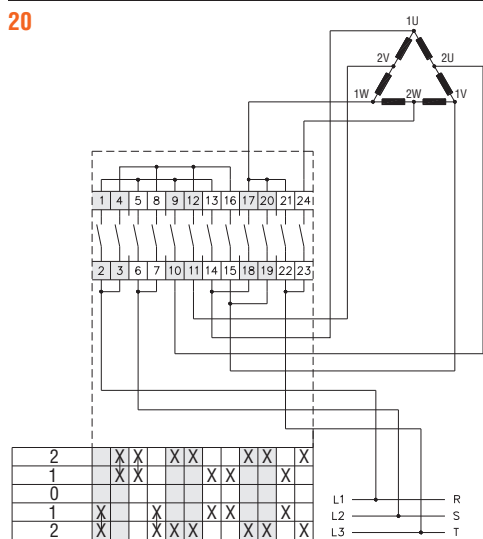
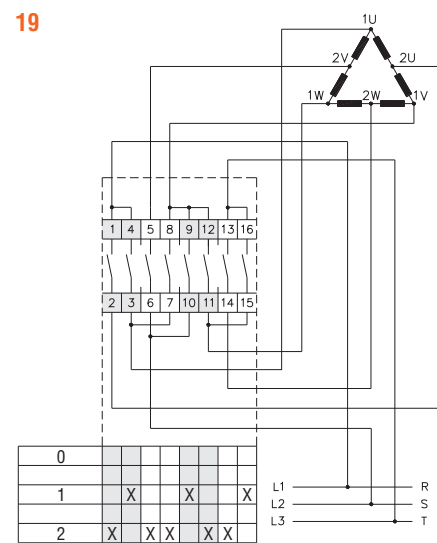
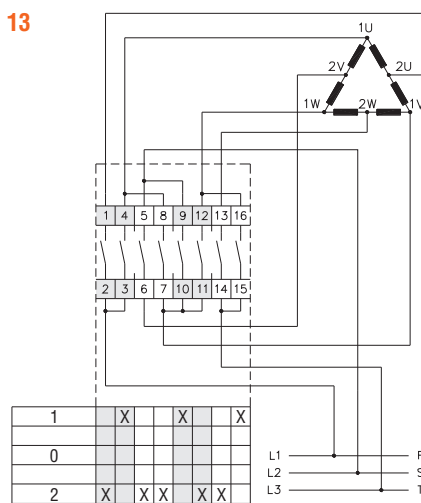
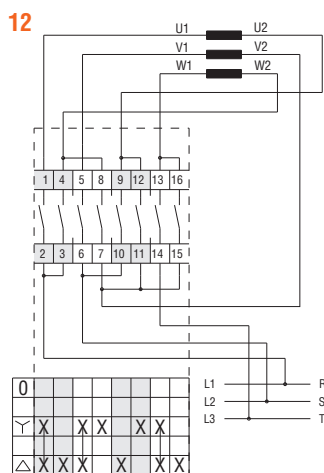
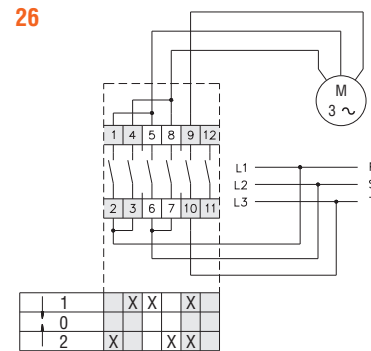
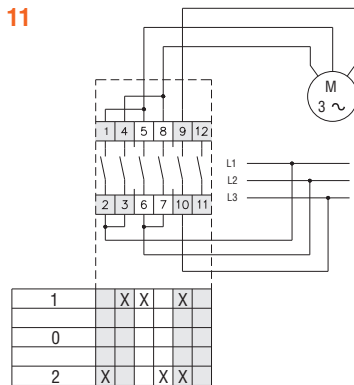
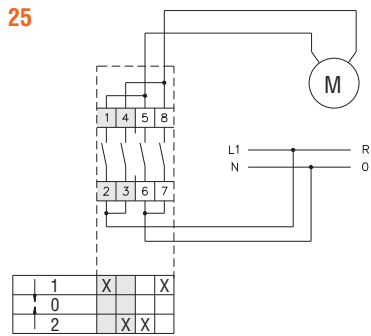

Technical characteristics

Series	Rated thermal current Ith [A]	UL/CSA general use [A]	UL/CSA horsepower ratings					Max. IEC AC23 power 1 phase [kW] at 230V	Max. IEC AC23 power 3 phases [kW] at 400V
			1 phase		3 phases				
			120V [HP]	240V [HP]	240V [HP]	480V [HP]	600V [HP]		
GF20...	20	15	—	1	3	—	—	2	7.5
7GN12...	16	15	0.5	1	3	—	—	1.7	5.5
7GN20...	20	20	0.75	2	3	7.5	10	2.5	7.5
7GN25...	25	30	1.5	3	5	10	15	3.7	11
7GN32...	32	40	2	5	10	15	15	4	15
7GN40...	40	50	2	5	10	20	20	6	18.5

Series	Rated thermal current Ith [A]	UL/CSA general use [A]	UL/CSA horsepower ratings					Max. IEC AC23 power 1 phase [kW] at 230V	Max. IEC AC23 power 3 phases [kW] at 400V
			1 phase		3 phases				
			120V [HP]	240V [HP]	240V [HP]	480V [HP]	600V [HP]		
GX16...	16	12	0.75	1	3	5	5	1.8	6.5
GX20...	20	15	0.75	1.5	3	5	5	2.2	7.5
GX32...	32	32	1.5	3	7.5	15	15	3.5	15
GX40...	40	40	2	5	10	15	15	5.2	18.5

MOTOR REVERSING, STAR-DELTA, DAHLANDER MOTOR CONTROL, SEPARATE WINDINGS SWITCHES

Cam switch in plastic enclosure with black handle (P)
Cam switch in metallic enclosure with black handle (L)



Type				Motor reversing			Star-delta	Dahlander motor control			Separate windings	
WIRING DIAGRAMS				25	11	26	12	13	19	20	53	
Series	Enclosure size	Rated thermal current I _{th}	UL/CSA general use									
	[mm]	[A]	[A]									
7GN...	75x75	16	15	7GN1225P	7GN1211P	7GN1226P	7GN1212P	7GN1213P	7GN1219P	—	7GN1253P	
		20	20	7GN2025P	7GN2011P	7GN2026P	7GN2012P	7GN2013P	7GN2019P	—	7GN2053P	
		25	30	7GN2525P	7GN2511P	7GN2526P	7GN2512P [Ⓢ]	7GN2513P [Ⓢ]	7GN2519P [Ⓢ]	—	7GN2553P	
	90x90	32	40	7GN3225P	7GN3211P	7GN3226P	7GN3212P	7GN3213P	7GN3219P	—	7GN3253P	
		110x110	40	50	7GN4025P	7GN4011P	7GN4026P	7GN4012P	7GN4013P	7GN4019P	—	7GN4053P
		125x175	63	60	7GN6325P	7GN6311P	7GN6326P	7GN6312P	7GN6313P	7GN6319P	—	7GN6353P
180x254	125	130	7GN12525P	7GN12511P	7GN12526P	7GN12512P	7GN12513P	7GN12519P	—	7GN12553P		
GX...	90x90	16	12	GX1625P	GX1611P	GX1626P	GX1612P	GX1613P	GX1619P	—	GX1653P	
		20	15	GX2025P	GX2011P	GX2026P	GX2012P	GX2013P	GX2019P	—	GX2053P	
	110x110	32	32	GX3225P	GX3211P	GX3226P	GX3212P	GX3213P	GX3219P	—	GX3253P	
		40	40	GX4025P	GX4011P	GX4026P	GX4012P	GX4013P	GX4019P	—	GX4053P	
GN...	250x316	200	200	GN20025L	GN20011L	GN20026L	GN20012L	GN20013L	GN20019L	GN20020L	GN20053L	
		315	255	GN31525L	GN31511L	GN31526L	GN31512L	GN31513L	GN31519L	GN31520L	GN31553L	

Cam switch in plastic enclosure with red/yellow handle (P25)



Type				Motor reversing			Star-delta	Dahlander motor control			Separate windings
WIRING DIAGRAMS				25	11	26	12	13	19	53	
Series	Enclosure size	Rated thermal current I _{th}	UL/CSA general use								
	[mm]	[A]	[A]								
7GN...	90x90	16	15	7GN1225P25	7GN1211P25	7GN1226P25	7GN1212P25	7GN1213P25	7GN1219P25	7GN1253P25	
		20	20	7GN2025P25	7GN2011P25	7GN2026P25	7GN2012P25	7GN2013P25	7GN2019P25	7GN2053P25	
		25	30	7GN2525P25	7GN2511P25	7GN2526P25	7GN2512P25 [Ⓢ]	7GN2513P25 [Ⓢ]	7GN2519P25 [Ⓢ]	7GN2553P25	
	110x110	32	40	7GN3225P25	7GN3211P25	7GN3226P25	7GN3212P25	7GN3213P25	7GN3219P25	7GN3253P25	
		125x175	63	60	7GN6325P25	7GN6311P25	7GN6326P25	7GN6312P25	7GN6313P25	7GN6319P25	7GN6353P25
		180x254	125	130	7GN12525P25	7GN12511P25	7GN12526P25	7GN12512P25	7GN12513P25	7GN12519P25	7GN12553P25
GX...	90x90	16	12	GX1625P25	GX1611P25	GX1626P25	GX1612P25	GX1613P25	GX1619P25	GX1653P25	
		20	15	GX2025P25	GX2011P25	GX2026P25	GX2012P25	GX2013P25	GX2019P25	GX2053P25	
	110x110	32	32	GX3225P25	GX3211P25	GX3226P25	GX3212P25	GX3213P25	GX3219P25	GX3253P25	
		40	40	GX4025P25	GX4011P25	GX4026P25	GX4012P25	GX4013P25	GX4019P25	GX4053P25	

Ⓢ Enclosure size 90x90mm.

WIRING DIAGRAMS

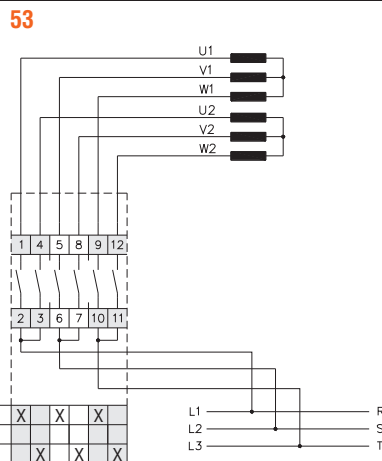
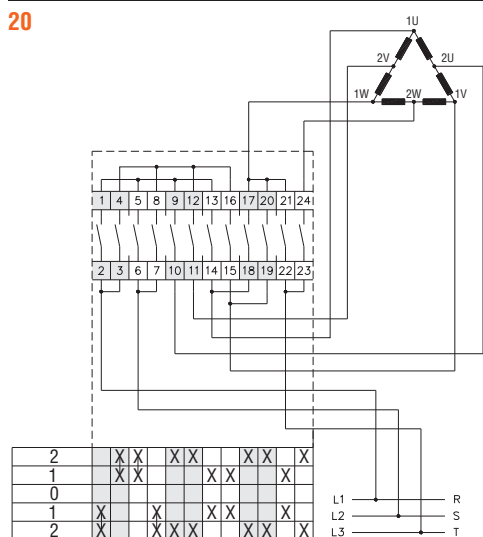
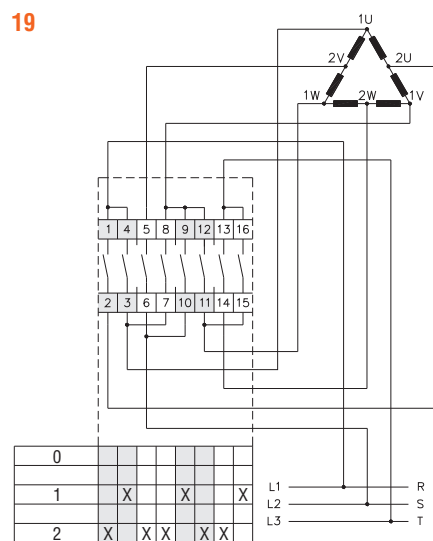
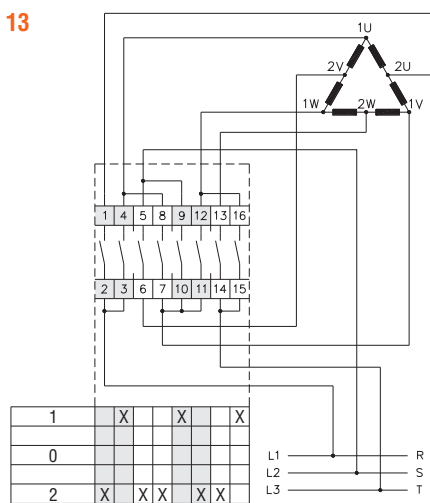
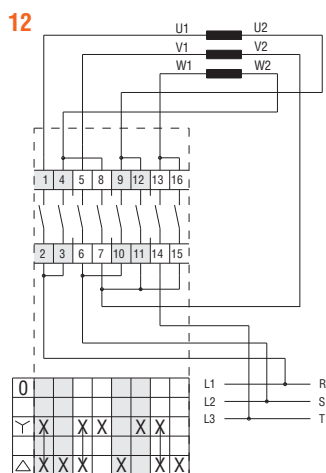
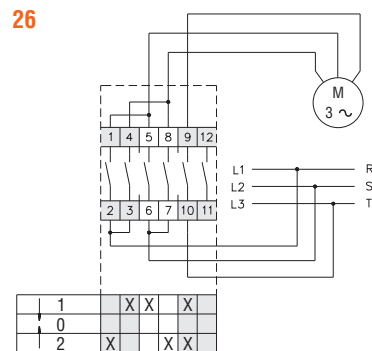
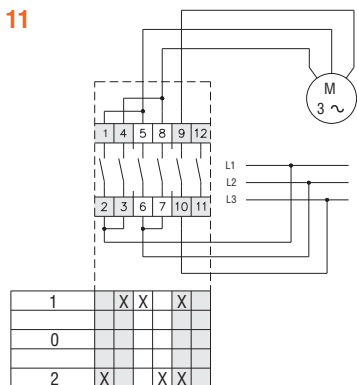
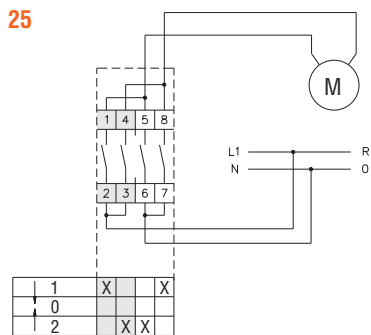

Technical characteristics

Series	Rated thermal current Ith [A]	UL/CSA general use [A]	UL/CSA horsepower ratings					Max. IEC AC23 power 1 phase [kW] at 230V	Max. IEC AC23 power 3 phases [kW] at 400V
			1 phase		3 phases				
			120V [HP]	240V [HP]	240V [HP]	480V [HP]	600V [HP]		
7GN12...	16	15	0.5	1	3	—	1.7	5.5	
7GN20...	20	20	0.75	2	3	7.5	2.5	7.5	
7GN25...	25	30	1.5	3	5	10	3.7	11	
7GN32...	32	40	2	5	10	15	4	15	
7GN40...	40	50	2	5	10	20	6	18.5	
7GN63...	63	60	3	10	15	25	7.5	30	
7GN125...	125	130	5	15	25	50	11	45	

Series	Rated thermal current Ith [A]	UL/CSA general use [A]	UL/CSA horsepower ratings					Max. IEC AC23 power 1 phase [kW] at 230V	Max. IEC AC23 power 3 phases [kW] at 400V
			1 phase		3 phases				
			120V [HP]	240V [HP]	240V [HP]	480V [HP]	600V [HP]		
GX16...	16	12	0.75	1	3	5	1.8	6.5	
GX20...	20	15	0.75	1.5	3	5	2.2	7.5	
GX32...	32	32	1.5	3	7.5	15	3.5	15	
GX40...	40	40	2	5	10	15	5.2	18.5	
GN200	200	200	15	30	50	100	—	47	
GN315	315	255	15	30	50	100	37	110	

11 Rotary cam switches

Versions and dimensions [mm]

Front mounting with black handle (U)



GF...

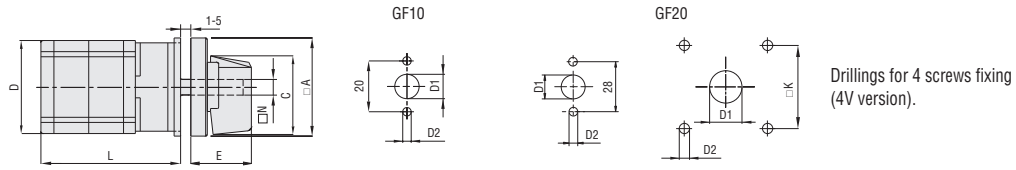

Drillings for 4 screws fixing (4V version).

Series	Dimensions								L Number of elements											
	□A	C	D	ØD1	ØD2	E	□K	N	1	2	3	4	5	6	7	8	9	10	11	12
GF10	30	24	29	9	3.2	18.5	-	Ø5	40	52	64	76	88	100	112	124	-	-	-	-
GF20	48	39.5	36	12	5	26.5	36	□6	44	57.5	71	84.5	98	111.5	125	138.5	152	165.5	179	192.5



7GN...

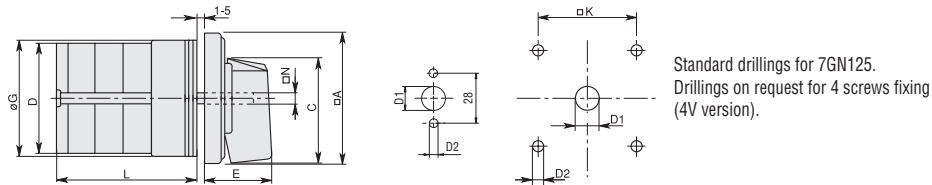

Standard drillings for 7GN125. Drillings on request for 4 screws fixing (4V version).

Series	Dimensions									L Number of elements											
	□A	C	ØD	ØD1	ØD2	E	ØG	□K	□N	1	2	3	4	5	6	7	8	9	10	11	12
7GN12	48	39.5	39	12	5	26.5	38	36	6	36.1	45.8	55.5	65.2	74.9	84.6	94.3	104	113.7	123.4	133.1	142.8
7GN20	48	39.5	39	12	5	26.5	38	36	6	36.1	45.8	55.5	65.2	74.9	84.6	94.3	104	113.7	123.4	133.1	142.8
7GN25	48	39.5	43	12	5	26.5	38	36	6	40.5	54.1	67.7	81.3	94.9	108.5	122.1	135.7	149.3	162.9	176.5	190.1
7GN32	65	53	58	14	5	34.5	58.5	48	7	46.5	61.6	76.7	91.8	106.9	122	137.1	152.2	167.3	182.4	197.5	212.6
7GN40	65	53	58	14	5	34.5	58.5	48	7	46.5	61.6	76.7	91.8	106.9	122	137.1	152.2	167.3	182.4	197.5	212.6
7GN63	65	53	62	14	5	34.5	58.5	48	7	50.3	68.4	86.5	104.6	122.7	140.8	158.9	177	195.1	213.2	231.3	249.4
7GN125	90	70.5	86	16	6	41.5	84	68	9	67.3	96.4	125.5	154.6	183.7	220.3	249.4	278.5	307.6	336.7	365.8	394.9



GX...

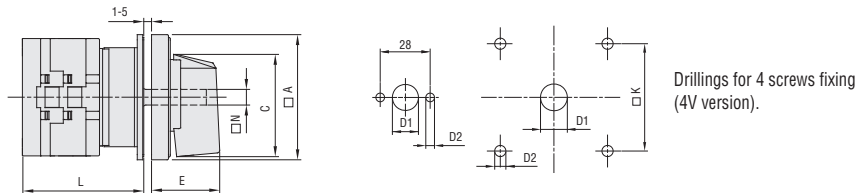

Drillings for 4 screws fixing (4V version).

Series	Dimensions							L Number of elements											
	□A	C	ØD1	ØD2	E	□K	□N	1	2	3	4	5	6	7	8	9	10	11	12
GX16	48	39.5	12	5	26.5	36	6	43	51.5	60	68.5	77	85.5	94	102.5	111	119.5	128	136.5
GX20	48	39.5	12	5	26.5	36	6	43	51.5	60	68.5	77	85.5	94	102.5	111	119.5	128	136.5
GX32	65	53	14	5	34.5	48	7	51	63	75	85	99	111	123	135	147	159	171	183
GX40	65	53	14	5	34.5	48	7	51	63	75	85	99	111	123	135	147	159	171	183



GN...

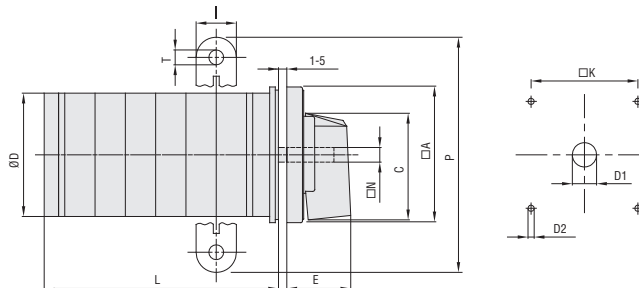

Series	Dimensions											L Number of elements											
	□A	C	ØD	ØD1	ØD2	E	I	□K	□N	P	ØT	1	2	3	4	5	6	7	8	9	10	11	12
GN200	132	104	120	16	5.3	56	20	104	10	140	10.5	77	107	136	166	196	226	284	314	343	373	402	432
GN315	132	104	120	16	5.3	56	20	104	10	145	10.5	77	107	136	166	196	226	284	314	343	373	402	432

● For devices with 6 or more elements please consult Technical support, see contact details on inside front cover.

Front mounting with red/yellow padlockable in 0 handle and protection covers (U25)

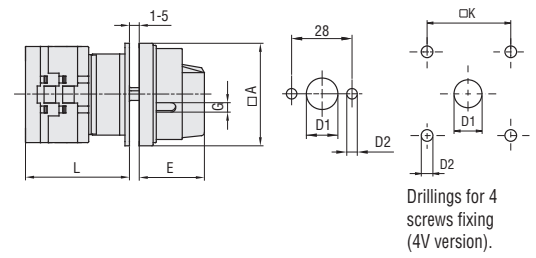
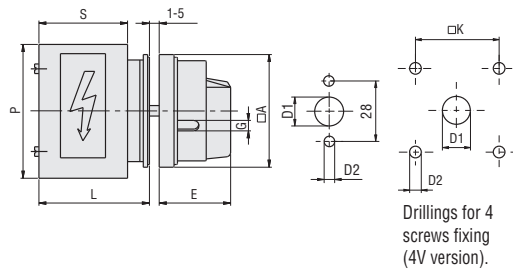

GF series

Series	Dimensions						L			
	□A	D1	D2	E	G	□K	1	2	3.....12	
GF20	48	12	5	34.2	5	36	44	57.5	71	192.5

GX series

Series	Dimensions						L			
	□A	D1	D2	E	G	□K	1	2	3.....12	
GX16	48	12	5	34.2	5	36	43	51.5	60	136.5
GX20	48	12	5	34.2	5	36	43	51.5	60	136.5
GX32	65	14	5	38	6	48	51	63	75	183
GX40	65	14	5	38	6	48	51	63	75	183

7GN series

Series	Dimensions									
	□A	D1	D2	E	G	□K	S	P	L	
7GN12	65	12	5	34.2	5	36	43	64	54.3	
7GN20	65	12	5	34.2	5	36	43	64	54.3	
7GN25	65	12	5	34.2	5	36	51	68	62.6	
7GN32	65	14	5	38	6	48	55	77	71.7	
7GN40	65	14	5	38	6	48	55	77	71.7	

Front mounting with red/yellow handle padlockable in 0 and protection covers (U65)

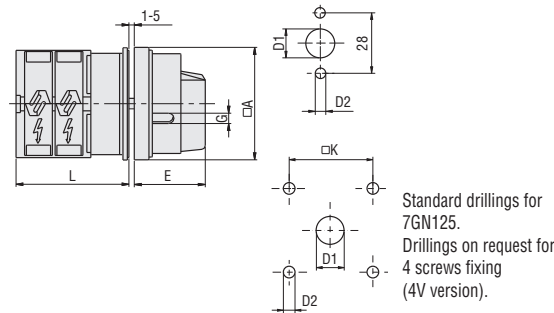

7GN series

Series	Dimensions						L			
	□A	D1	D2	E	G	□K	1	2	3.....12	
7GN12	65	12	5	34.2	5	36	36.1	45.8	55.5	142.8
7GN20	65	12	5	34.2	5	36	36.1	45.8	55.5	142.8
7GN25	65	12	5	34.2	5	36	40.5	54.1	67.7	190.1
7GN32	65	14	5	38	6	48	46.5	61.6	76.7	212.6
7GN40	65	14	5	38	6	48	46.5	61.6	76.7	212.6
7GN63	65	14	5	38	6	48	50.3	68.4	86.5	249.4
7GN125	90	16	6	49	7	68	67.3	96.4	125.5	394.9

Front mounting with black handle with IP65 front protection (U51)

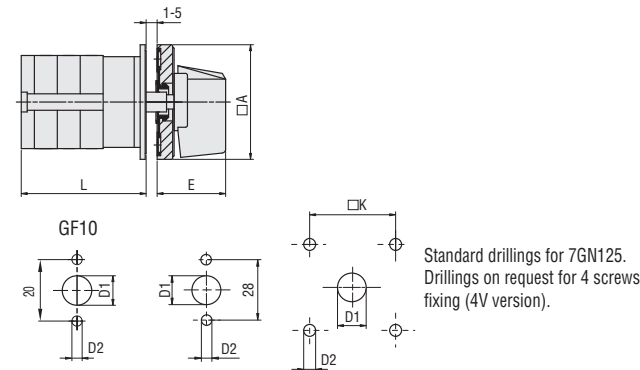

GF series

Series	Dimensions					L			
	□A	D1	D2	E	□K	1	2	3.....12	
GF10	30	9	3.2	18.5	-	40	52	64	1
GF20	48	12	5	26.5	36	44	57.5	71	192.5

● GF10: max. 8 elements.

7GN series

Series	Dimensions					L			
	□A	D1	D2	E	□K	1	2	3.....12	
7GN12	48	12	5	26.5	36	36.1	45.8	55.5	142.8
7GN20	48	12	5	26.5	36	36.1	45.8	55.5	142.8
7GN25	48	12	5	26.5	36	40.5	54.1	67.7	190.1
7GN32	65	14	5	34.5	48	46.5	61.6	76.7	212.6
7GN40	65	14	5	34.5	48	46.5	61.6	76.7	212.6
7GN63	65	14	5	34.5	48	50.3	68.4	86.5	249.4
7GN125	90	16	6	41.5	68	67.3	96.4	125.5	394.9

11 Rotary cam switches

Versions and dimensions [mm]

Front mounting with black handle without front plate for hole Ø22mm fixing (U11)

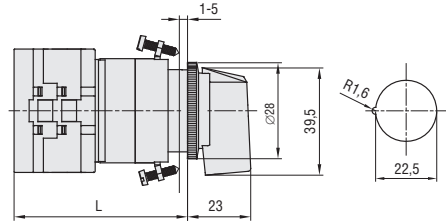
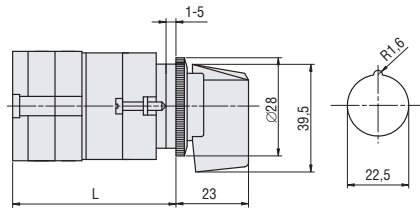

GF series

Series	L			
	1	2	3.....12	
GF20	54.5	68	81.5	203

GX series

Series	L			
	1	2	3.....12	
GX16	54	62.5	71	147.5
GX20	54	62.5	71	147.5

7GN series

Series	L			
	1	2	3.....8	
7GN12	47	56.7	66.4	114.9
7GN20	47	56.7	66.4	114.9
7GN25	51.4	65	78.6	146.6

Front mounting without front plate with key operation for hole Ø22mm fixing (U12)

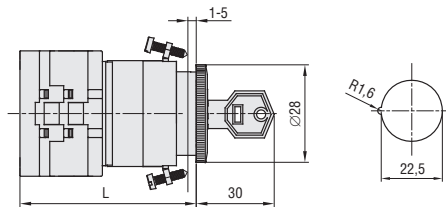
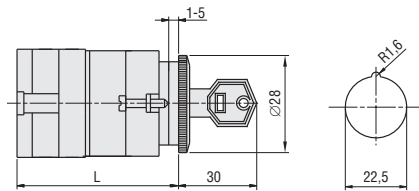

GF series

Series	L			
	1	2	3.....8	
GF20	54.5	68	81.5	149

GX series

Series	L			
	1	2	3.....8	
GX16	54	62.5	71	113.4
GX20	54	62.5	71	113.4

7GN series

Series	L			
	1	2	3.....8	
7GN12	47	56.7	66.4	114.9
7GN20	47	56.7	66.4	114.9
7GN25	51.4	65	78.6	146.6

Snap on front mounting with black handle for hole Ø22mm fixing (U47)

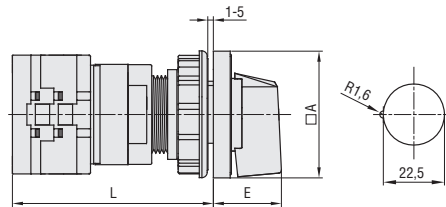
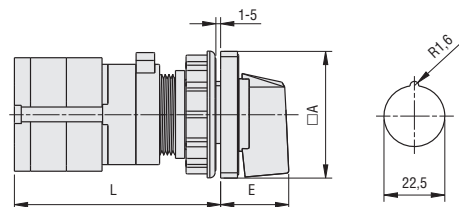

GF series

Series	Dimensions		L			
	□A	E	1	2	3.....8	
GF10	30	18.5	60	72	84	144
GF20	48	26.5	56	69.5	83	150.5

GX series

Series	Dimensions		L			
	□A	E	1	2	3.....8	
GX16	48	26.5	64.9	73.4	81.9	124.4
GX20	48	26.5	64.9	73.4	81.9	124.4

7GN series

Series	Dimensions		L			
	□A	E	1	2	3.....8	
7GN12	48	26.5	58	67.7	77.4	125.9
7GN20	48	26.5	58	67.7	77.4	125.9
7GN25	48	26.5	62.4	76	89.6	157.6

11 Rotary cam switches

Versions and dimensions [mm]

Rear mounting with black handle (0)

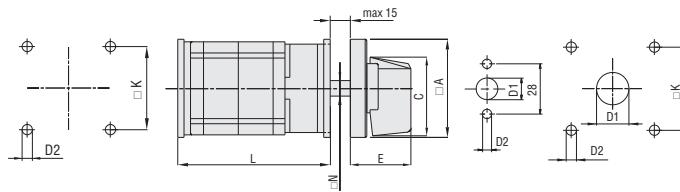

Series	Dimensions							L Number of elements											
	□A	C	ØD1	ØD2	E	□K	N	1	2	3	4	5	6	7	8	9	10	11	12
GF20	48	39.5	12	5	26.5	36	□6	46	59.5	73	86.5	100	113.5	127	140.5	154	167.5	181	194.5

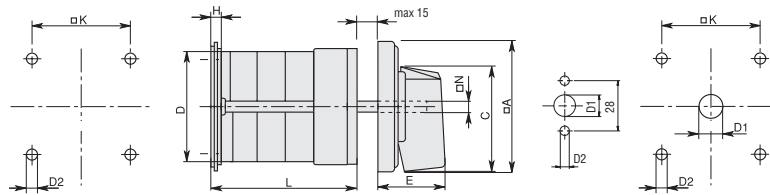

Series	Dimensions								L Number of elements											
	□A	C	ØD	ØD2	E	H	□K	□N	1	2	3	4	5	6	7	8	9	10	11	12
7GN12	48	39.5	39	5	26.5	5	36	6	38.1	47.8	57.5	67.2	76.9	86.6	96.3	106	115.7	125.4	135.1	144.8
7GN20	48	39.5	39	5	26.5	5	36	6	38.1	47.8	57.5	67.2	76.9	86.6	96.3	106	115.7	125.4	135.1	144.8
7GN25	48	39.5	43	5	26.5	5	36	6	42.5	56.1	69.7	83.3	96.9	110.5	124.1	137.7	151.3	164.9	178.5	192.1
7GN32	65	53	58	5	34.5	5.5	48	7	48.5	63.6	78.7	93.8	108.9	124	139.1	154.2	169.3	184.4	199.5	214.6
7GN40	65	53	58	5	34.5	5.5	48	7	48.5	63.6	78.7	93.8	108.9	124	139.1	154.2	169.3	184.4	199.5	214.6
7GN63	65	53	62	6	34.5	7.5	68	7	53.3	71.4	89.5	107.6	125.7	143.8	161.9	180	198.1	216.2	234.3	252.4
7GN125	90	70.5	86	6	41.4	7.5	68	9	74.8	103.9	133	162.1	191.2	220.3	249.4	278.5	307.6	336.7	365.8	394.9

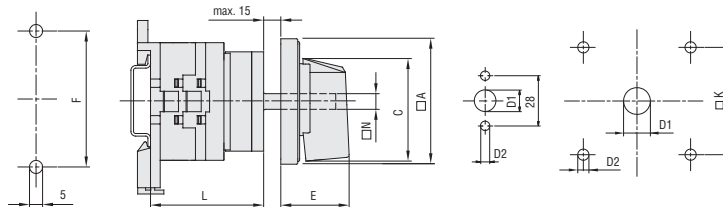

Series	Dimensions					L Number of elements											
	□A	C	E	F	□N	1	2	3	4	5	6	7	8	9	10	11	12
GX16	48	39.5	26.5	52	6	37	45.5	54	62.5	71	79.5	88	96.5	105	113.5	122	130.5
GX20	48	39.5	26.5	52	6	37	45.5	54	62.5	71	79.5	88	96.5	105	113.5	122	130.5
GX32	65	53	34.5	68	7	48	60	72	84	96	108	120	132	144	156	168	180
GX40	65	53	34.5	68	7	48	60	72	84	96	108	120	132	144	156	168	180

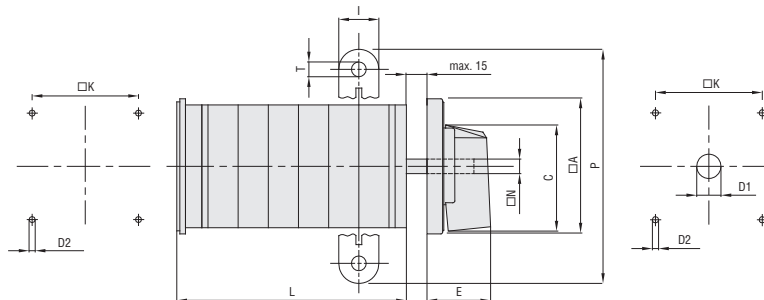

Series	Dimensions									L Number of elements ①											
	□A	C	ØD2	E	I	□K	□N	P	ØT	1	2	3	4	5	6	7	8	9	10	11	12
GN200	132	104	5.3	56	20	104	10	140	10.5	77	107	136	166	196	226	284	314	343	373	402	432
GN315	132	104	5.3	56	20	104	10	145	10.5	77	107	136	166	196	226	284	314	343	373	402	432

① For devices with 6 or more elements please contact please consult Technical support, see contact details on inside front cover.

Modular service cover for 35mm DIN rail mounting with black handle (048)

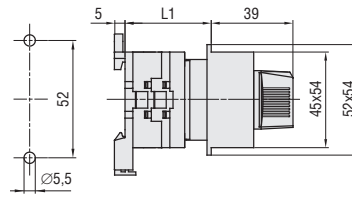
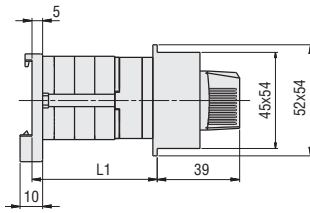

GF series

Series	L1		
	1	2	3
GF20	40	53.5	67

GX series

Series	L1		
	1	2	3
GX16	33	41.5	50
GX20	33	41.5	50

7GN series

Series	L1		
	1	2	3
7GN12	38.1	47.8	57.5
7GN20	38.1	47.8	57.5
7GN25	42.5	56.1	69.7

Rear mounting with red/yellow handle padlockable in 0, door coupling and protection covers (088)

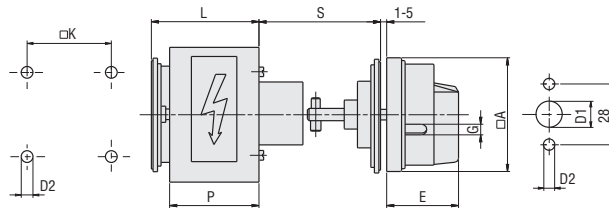

GF series

Series	Dimensions							L			
	□A	D1	D2	E	G	□K	S	1	2	3.....12	
GF20	48	12	5	34.2	5	36	45-55	46	59.5	73	194.5

7GN series

Series	Dimensions									
	□A	D1	D2	E	G	□K	S	P	L	
7GN12	65	12	5	34.2	5	36	45-55	43	51.3	
7GN20	65	12	5	34.2	5	36	45-55	43	51.3	
7GN25	65	12	5	34.2	5	36	45-55	51	59.6	
7GN32	65	14	5	38	6	48	45-55	55	68.7	
7GN40	65	14	5	38	6	48	45-55	55	68.7	

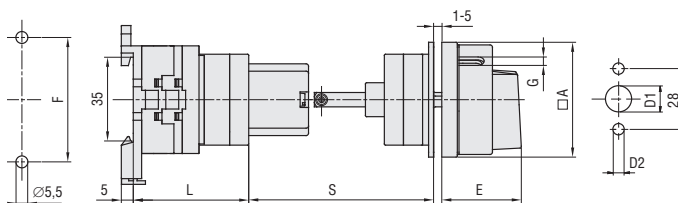

GX series

Series	Dimensions								L			
	□A	D1	D2	E	F	□K	G	S	1	2	3.....12	
GX16	48	12	5	34.2	52	36	5	45-55	40	48.5	57	133.5
GX20	48	12	5	34.2	52	36	5	45-55	40	48.5	57	133.5
GX32	65	14	5	38	68	48	6	45-55	51	63	75	183
GX40	65	14	5	38	68	48	6	45-55	51	63	75	183

11 Rotary cam switches

Versions and dimensions [mm]

Rear mounting with red/yellow handle padlockable in 0, door coupling and protection covers (098)

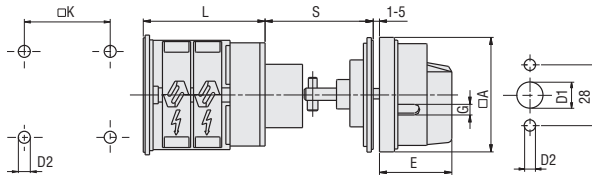
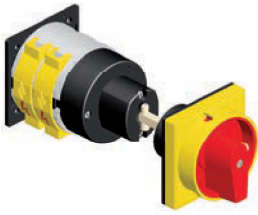

Series	Dimensions							L			
	□A	D1	D2	E	G	□K	S	1	2	3.....12	
7GN12	65	12	5	34.2	5	36	45-55	41.1	50.8	60.5	147.8
7GN20	65	12	5	34.2	5	36	45-55	41.1	50.8	60.5	147.8
7GN25	65	14	5	38	6	48	45-55	51.5	66.6	81.7	217.6
7GN40	65	14	5	38	6	48	45-55	51.5	66.6	81.7	217.6
7GN63	65	14	6	38	6	68	45-55	57.3	75.4	93.5	256.4

Cam switch in plastic enclosure with black handle (P)

Cam switch in metallic enclosure with black handle (L)

Cam switch in plastic enclosure with red/yellow handle (P25)

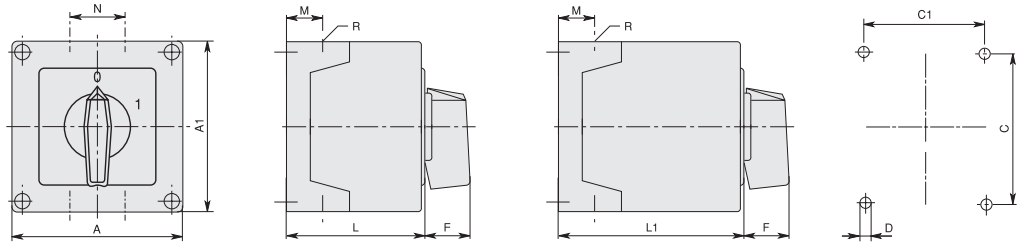

Series	Enclosure size	Number of elements		Dimensions									Cable entry	Protection degree	
		L	L1	A	A1	C	C1	D	F	M	N	L			L1
7GN12	75x75	1 - 2	3 - 4	75	75	50	64	4.5	19	14	28	57.5	79.8	4xPG13.5	IP65
7GN20		1 - 2	3 - 4												
7GN25		1	2 - 3												
7GN12	90x90	1 - 3	4 - 6	90	90	79	63	4.5	25	19	30	71.3	98.3	4xPG16	IP65
7GN20		1 - 3	4 - 6												
7GN25		1 - 2	3 - 4												
7GN32		1 - 2	3 - 4												
7GN40		1	2 - 3												
7GN12	110x110	1 - 4	5 - 8	110	110	98.4	83	4.5	32	21	39.5	85.5	119.5	4xPG21	IP65
7GN20		1 - 4	5 - 8												
7GN25		1 - 3	4 - 5												
7GN32		1 - 3	4 - 5												
7GN40		1 - 2	3 - 5												
7GN63	1 - 2	3 - 4													
7GN32	125x175	1 - 3	4 - 5	125	175	146	112	5.5	32	21	68	84.3	118.3	4xPG21 2xPG11	IP65
7GN40		1 - 2	3 - 4												
7GN63		1 - 2	3 - 4												
7GN125		1	2												
7GN32	180x254	1 - 5	6 - 8	180	254	120	190	5.5	32	35	76	121	175	4xPG29 2xPG11	IP65
7GN40		1 - 4	5 - 7												
7GN63		1 - 3	4 - 6												
7GN125		1 - 2	3 - 4												
GX16	90x90	1 - 2	3 - 5	90	90	79	79	4.5	25	19	30	71.3	98.3	4xPG16	IP65
GX20		1 - 2	3 - 5												
GX16	110x110	1 - 3	4 - 7	110	110	98.4	83	4.5	32	21	39.5	85.5	119.5	4xPG21	IP65
GX20		1 - 3	4 - 7												
GX32		1 - 2	3 - 4												
GX40		1 - 2	3 - 4												

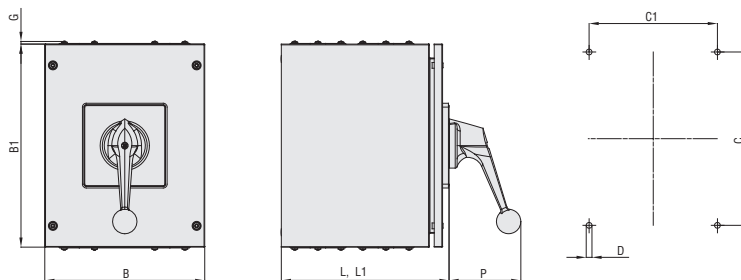

Series	Enclosure size	Number of elements		Dimensions										Protection degree
		L	L1	L	L1	B	B1	C	C1	D	G	P		
GN200	250x316	1 - 3	4 - 6	162	252	250	316	270	200	9	4.5	98	IP54	
GN315		1 - 3	4 - 6	162	252	250	316	270	200	9	4.5	98		

ROTARY CAM SWITCH GNA20 SERIES

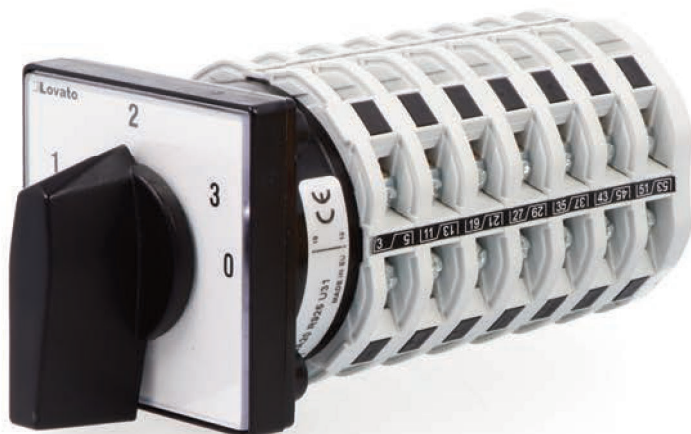

● IEC CONVENTIONAL FREE AIR THERMAL CURRENT ITH 20A.

Front mounting with black handle

● AVAILABLE VERSIONS IN PLASTIC ENCLOSURE.

● 48 AVAILABLE CONTACTS

The GNA20 series of cam switches has 4 contacts for each element. It can have a maximum of 12 control positions with 12 switching elements for a total of **48 contacts available**.

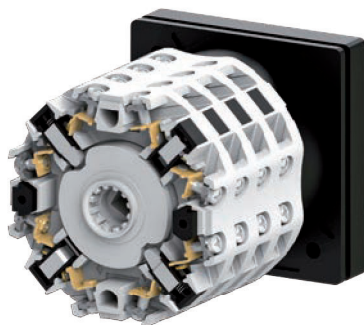

Front mounting with padlockable yellow/red handle

● REDUCED DEPTH

The GNA20 series cam switches are used in applications where the depths available inside the panel are limited.

Comparison example between GNA20 and 7GN series:

GNA20 series: 6 elements, 24 contacts.

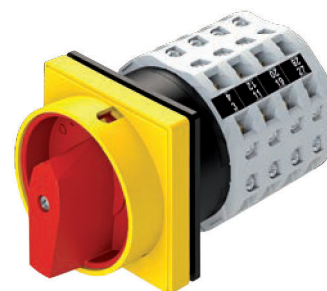
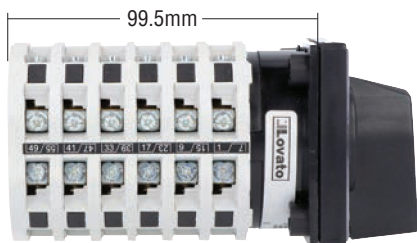

Rear mounting with black handle

7GN series: 12 elements, 24 contacts.

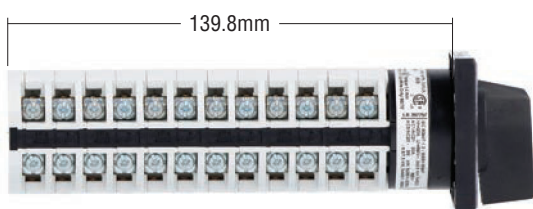

Consult Technical support to determine the order codes relating to the GNA20 series; see contact details on inside front cover.

Accessories for rotary cam switches



7A014 - 7AR114 -
7A114 - 7AR214



7AR124 - 7A124 -
7AR224 - 7AR324



GXM0 - GXM1 - GXM2 - GXM3 - GXM4



GXM5 - GXM6 - GXM7



7A019... -
7A119...

7A169...



7A180 - 7A181



7A44...

Order code	Description	Qty per pkg	Wt [kg]
		n°	[kg]

Black operating handle^①.

7A014	For 48x48mm front plate □6mm/0.24"	1	0.005
7AR114	For 65x65mm front plate □6mm/0.24"	1	0.010
7A114	For 65x65mm front plate □7mm/0.28"	1	0.010
7AR214	For 90x90mm front plate □7mm/0.28"	1	0.013

Black operating lever^①.

7AR124	For 65x65mm front plate □6mm/0.24"	1	0.019
7A124	For 65x65mm front plate □7mm/0.28"	1	0.020
7AR224	For 90x90mm front plate □7mm/0.31"	1	0.038
7AR324	For 132x132mm front plate	1	0.050

Red/yellow 0-1 padlockable handle.

GXA01	48x48mm □6mm/0.24"	1	0.030
GXA01H	48x48mm □7mm/0.28"	1	0.047
GXA11	65x65mm □7mm/0.28"	1	0.047

IP40 front plate.

GXM0	30x30mm/1.2x1.2" blank front plate	1	0.012
GXM1	48x48mm/1.9x1.9" blank front plate	1	0.018
GXM2	65x65mm/2.6x2.6" blank front plate	1	0.023
GXM3	90x90mm/3.6x3.6" blank front plate	1	0.030
GXM4	132x132mm/5.2x5.2" blank front plate	1	0.040

IP40 front plate with legend plate.

GXM5	48x60mm/1.9x2.6" blank front plate with legend	1	0.017
GXM6	65x80mm/2.6x3.1" blank front plate with legend	1	0.033
GXM7	90x110mm/3.6x4.4" blank front plate with legend	1	0.055

IEC IP20 finger protection shroud for supply terminals.
For 2 wafers complete with screws and bracket.

7A0191	For 7GN12-7GN20	1	0.017
7A0192	For 7GN25	1	0.021
7A119U	For 7GN32-7GN40 U version	1	0.033
7A119O	For 7GN32-7GN40 O version	1	0.101

2-piece kit, snap-on fixing for 1 wafer.

7A1691	For 7GN32-7GN40	1	0.005
7A1692	For 7GN63	1	0.006
7A1693	For 7GN125	1	0.020
7A1694	For 7GN12-7GN20	1	0.005
7A1695	For 7GN25	1	0.005

35mm DIN rail (IEC/EN/BS 60715) base mounting piece for U version.

7A180	For 7GN12...7GN25 and GF20	1	0.011
7A181	For 7GN32...7GN63	1	0.018

IP42 rubber protection^②. Plug-in.

7A441	Ø57mm/2.3" - 90mm/3.6" long for 7GN12-7GN20-7GN25 up to 2 elements	1	0.045
7A442	Ø57mm/2.3" - 115mm/4.6" long for 7GN12-7GN20-7GN25 up to 4 elements	1	0.065
7A443	Ø57mm/2.3" - 140mm/5.5" long for 7GN12-7GN20-7GN25 up to 6 elements	1	0.063
7A444	Ø87mm/3.4" - 112mm/4.0" long for 7GN32...7GN40 up to 4 elements, for 7GN63 up to 3 elements	1	0.065

① For shaft dimensions, refer to the dimension □N present in the various executions.

② Increases contact degree of protection from IEC IP00 to IP20.

11 Rotary cam switches

Technical characteristics

TYPE		GF10	GF20	7GN12	7GN20	7GN25	7GN32	7GN40	7GN63	7GN125	GX16	GX20	GX32	GX40	GN200	GN315	GNA20	
Rated insulation voltage																		
Ui IEC/EN/BS	V	480	480	690	690	690	690	690	690	690	690	690	690	690	690	690	690	
UL/CSA	V	240	240	600	600	600	600	600	600	600	600	600	600	600	600	600	600	
Rated impulse withstand voltage																		
Uimp IEC/EN/BS 60947-3	kV	4	4	6	6	6	6	6	6	6	6	6	6	6	8	8	6	
Conventional free air thermal current																		
Ith IEC/EN/BS	A	10	20	16	20	25	32	40	63	125	16	20	32	40	200	315	20	
UL/CSA (general purpose)	A	10	15	15	20	30	40	50	60	130	12	15	32	40	200	255	15	
Rated operating maximum voltage (only for switch)	V	480	480	480	480	480	480	480	480	690	440	440	440	440	690	690	480	
Rated operational impulse voltage (only for switch)	kV	4	4	4	4	4	4	4	4	6	4	4	4	4	6	6	4	
Maximum fuse size for short-circuit protection																		
In (gG)	10kA	A	16	20	16	20	25	32	40	63	125	16	20	35	40	200 [Ⓜ]	315 [Ⓜ]	20
	15kA	A	–	20	10	16	25	32	40	63	100	16	20	35	35	200 [Ⓜ]	315 [Ⓜ]	20
	25kA	A	–	20	10	16	25	32	40	63	100	16	20	35	35	–	–	20
	50kA	A	–	–	–	–	–	32	40	63	100	–	–	–	–	–	–	–
	63kA	A	–	–	–	–	–	–	40	63	100	–	–	–	–	–	–	–
Short-time withstand current																		
Icw 1sec	A	250	250	200	250	400	800	1000	1600	2100	250	250	1000	1000	3300	5200	220	
Conductivity	mA/V	10/5	10/5	10/5	10/5	10/5	10/5	10/5	10/5	10/5	10/5	10/5	10/5	10/5	–	–	10/5	
Rated operational current																		
Ie AC1/AC21A (IEC/EN/BS)	A	10	20	16	20	25	32	40	63	125	16	20	32	40	200	315	20	
AC15 (IEC/EN/BS) 110...120V	A	5	10	10	10	16	25	25	32	40	10	10	25	25	–	–	–	
220...230V	A	3	8	8	8	12	20	22	25	28	8	8	20	22	–	–	–	
380...400V	A	2	6	4	6	8	10	12	15	15	4	6	10	12	–	–	–	
660...690V	A	–	–	1.5	1.5	2	2	2	4	5	1.5	1.5	2	2	–	–	–	
Motor power for switches in AC utilisation category																		
AC3 (IEC/EN/BS) 220...230V	kW	1.5	3	2.5	3	5.5	7.5	8	11	18.5	3.5	3.7	7.5	7.5	27.5	37	3	
3 phases 380...440V	kW	2.2	5	4	5.5	7.5	11	15	18.5	37	4.5	5.5	11	15	47	55	5.5	
500...690V	kW	–	–	5.5	5.5	7.5	11	15	18.5	33	5.5	5.5	11	15	–	69	5.5	
1 phase (2 poles) 110...120V	kW	0.3	0.5	0.8	0.8	1.5	2.2	3	3.7	5	0.55	0.75	1.8	2.2	–	11	0.6	
220...230V	kW	0.55	1.5	1.5	2.2	3	4	6.5	6.5	11	1.5	1.8	3.5	4.4	–	22	2.2	
380...440V	kW	0.75	2	2.2	3	5.5	6.5	8	11.5	15	2.2	3	5.5	7	–	30	3	
AC23A (IEC/EN/BS) 220...230V	kW	1.8	4	3	5	6.5	8	8	12.5	30	3.7	4	8	9	–	75	3.7	
3 phases 380...440V	kW	3	7.5	5.5	7.5	11	15	18.5	30	45	6.5	7.5	15	18.5	47	110	7.5	
500...690V	kW	–	–	7.5	7.5	11	18.5	22	30	37	7.5	7.5	15	15	–	45	7.5	
1 phase (2 poles) 110...120V	kW	0.7	0.75	0.8	0.8	1.5	2.2	3	3.7	5	0.75	0.75	2.2	3	–	15	0.75	
220...230V	kW	0.75	2	1.7	2.5	3.7	4	6	7.5	11	1.8	2.2	3.5	5.2	–	37	2.2	
380...440V	kW	1.1	2.5	3	3.7	5.5	7.5	11	12.5	15	3	3.5	6	7.5	–	55	3.7	

① For GN200 and GN315 the use category is AC23B.

Ⓜ aR fuses.

11 Rotary cam switches

Technical characteristics

TYPE		GF10	GF20	7GN12	7GN20	7GN25	7GN32	7GN40	7GN63	7GN125	GX16	GX20	GX32	GX40	GN200	GN315	GNA20	
Motor power for direct-on-line control (UL/CSA-DOL) 3 phases	120V	HP	–	–	1.5	1.5	3	5	5	7.5	15	1.5	1.5	3	5	30	30	1.5
	240V	HP	2	3	3	3	5	10	10	15	25	3	3	7.5	10	50	50	2
	480V	HP	–	–	–	7.5	10	15	20	25	50	5	5	15	15	100	100	5
	600V	HP	–	–	–	10	15	15	20	25	40	5	5	15	15	75	75	5
1 phase (2 poles)	120V	HP	–	–	0.5	0.75	1.5	2	2	3	5	0.75	0.75	1.5	2	15	15	–
	240V	HP	0.75	1	1	2	3	5	5	10	15	1	1.5	3	5	30	30	–
Motor power for switches in DC utilisation category																		
DC21A	48V	A	10	20	12	20	25	32	40	63	125	16	20	32	40	200	200	–
	60V	A	7	20	12	20	25	32	40	50	80	16	20	32	40	200	200	–
	110V	A	2	4	4	4	4	6	6	8	10	4	4	5	6	35	35	–
	220V	A	0.7	0.7	0.6	0.6	0.7	0.9	0.9	1	1.2	0.6	0.6	0.8	0.8	2.5	2.5	–
	440V	A	0.2	0.2	0.25	0.25	–	–	–	–	–	0.25	0.25	0.25	0.25	0.9	0.9	–
DC23A	24V	A	–	–	10(1)	20(1)	25(1)	32(1)	40(1)	50(1)	125(1)	16(1)	20(1)	32(1)	40(1)	–	–	–
	48V	A	–	–	10(2)	20(2)	25(2)	32(2)	40(2)	50(2)	125(2)	16(2)	20(2)	32(2)	40(1)	–	–	–
	60V	A	–	–	10(3)	20(3)	25(3)	32(3)	40(3)	50(3)	125(3)	16(3)	20(3)	32(3)	40(3)	–	–	–
No. of contacts connected in series are indicated in brackets	110V	A	–	–	5(3)	10(3)	12(3)	15(3)	20(3)	25(3)	50(3)	10(3)	10(3)	15(3)	40(3)	–	–	–
	220V	A	–	–	5(4)	8(4)	10(4)	12(4)	12(4)	15(4)	20(4)	7(4)	8(4)	12(4)	12(4)	–	–	–
DC13	24V	A	3	6	12	20	25	32	40	63	125	16	20	32	40	–	–	–
	48V	A	3	6	10	16	20	25	32	40	100	14	16	25	32	–	–	–
	60V	A	2	3	8	12	16	16	16	28	50	10	12	14	16	–	–	–
	110V	A	1	1	1	1	1.5	3	3	3.3	4	1	1	3	3	–	–	–
	220V	A	0.3	0.4	0.4	0.4	0.4	0.5	–	–	–	0.4	0.4	0.5	0.5	–	–	–
440V	A	0.1	0.15	0.15	0.15	–	–	–	–	–	0.15	0.15	0.15	0.15	–	–	–	
Power dissipation	w/pole	0.4	0.8	0.8	0.8	1.1	1.5	2.0	3.4	6.3	0.6	0.6	1.6	1.6	26	64.5	1	
Mechanical life	cycles	1x10 ⁶	1x10 ⁶	3x10 ⁶	5x10 ⁶	5x10 ⁶	5x10 ⁶	5x10 ⁶	5x10 ⁶	1x10 ⁶	1x10 ⁶	1x10 ⁶	1x10 ⁶	1x10 ⁶	2x10 ⁵	2x10 ⁵	1x10 ⁶	
Terminal screw	M	2.5	3	3	3	3.5	4	4	5	2x5	3	3	4	4	10	10	3	
Tightening torque	max	Nm	0.4	0.5	0.5	0.5	0.8	1.2	1.2	2	2	0.5	0.8	1.2	1.2	10	10	0.5
Conductor cross section	max. r/f	2xmm ²	1.5/1.5	2.5/2.5	2.5/2.5	2.5/2.5	4/4	6/4	10/6	16/10	50/50	2.5/2.5	2.5/2.5	10/6	10/6	1x95	1x185	2.5/25
	min. r/f	2xAWG	14/14	12/12	12/14	12/14	10/12	8/10	8/10	6/8	1/0/1/0	12/12	12/12	8/10	8/10	1x3/0	1xmcmm 350	12/14
r: rigid/solid		2xmm ²	0.5/0.5	0.5/0.5	0.5/0.5	0.5/0.5	1.5/1.5	1.5/1.5	2.5/2.5	2.5/2.5	0.5/0.5	0.5/0.5	1.5/1.5	1.5/1.5	–	–	0.5/0.5	
f: flexible/stranded		2xAWG	20/20	20/20	20/20	20/20	16/16	16/16	14/14	14/14	20/20	20/20	16/16	16/16	–	–	20/20	
AMBIENT CONDITIONS																		
Operating temperature	°C	–25...+55																
Storage temperature	°C	–40...+70																



- 16A to 1600A ratings
- Versions: direct operating handle, door coupling, door mount and in enclosure
- Wide range of accessories
- Type for photovoltaic applications up to 850A, 1000VDC (DC21B)
- Switch disconnectors and changeover switches in plastic, metal and stainless steel AISI 304 enclosure.

	SEC. - PAGE
GA series 16A to 160A	
Three-pole switch disconnectors	12 - 9
Fourth pole add-on.....	12 - 9
Add-on blocks and accessories	12 - 11
Assembled changeover switches	12 - 17
Switch disconnectors complete with shaft extension, door-coupling handle and terminal covers	12 - 17
Empty plastic enclosures	12 - 18
Switch disconnectors in plastic enclosure	12 - 19
Changeover switches in plastic enclosure	12 - 21
Switch disconnectors in metal enclosure	12 - 23
Changeover switches in metal enclosure	12 - 24
Switch disconnectors in stainless steel AISI 304 enclosure	12 - 24
Empty metal enclosures	12 - 25
GL series 160A to 630A	
Three-pole switch disconnectors	12 - 30
Fourth pole add-on.....	12 - 30
Three and four-pole changeover switches	12 - 31
Add-on blocks and accessories	12 - 32
Switch disconnectors in metal enclosure	12 - 34
Changeover switches in metal enclosure	12 - 35
GE series 50A to 1600A	
Three-pole switch disconnectors	12 - 36
Three-pole switch disconnectors with fuse holder	12 - 36
Four-pole switch disconnectors	12 - 37
Four-pole switch disconnectors with fuse holder	12 - 37
Three-pole changeover switches	12 - 38
Four-pole changeover switches	12 - 38
Add-on blocks and accessories	12 - 39
GM series 30A to 800A	
Three-pole disconnect switches with fuse holder (UL98)	12 - 44
Add-on blocks and accessories	12 - 44
For photovoltaic applications	12 - 46
Dimensions	12 - 48
Wiring diagrams	12 - 61
Technical characteristics	12 - 64



Page 12-8

GA SERIES 16A TO 160A (AC21A)

- UL60947-4-1 and UL98 certified three-pole switch disconnectors; add-on fourth pole available
- Switch disconnectors with direct operating handle and door coupling version
- Switch disconnectors door mount version
- Switch disconnectors in plastic, metal and AISI 304 stainless-steel enclosure
- Changeover switches in plastic and metal enclosure.

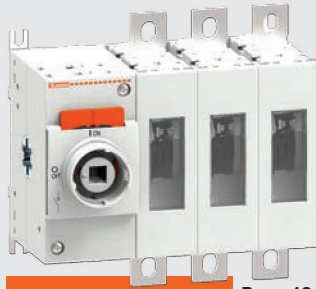

Page 12-26

GL SERIES 160A TO 630A (AC23A)

- IEC and UL98 certified three-pole switch disconnectors; add-on fourth pole available
- IEC and UL1008 certified changeover switches
- Switch disconnectors with direct operating handle and door coupling version
- Changeover switches with direct operating handle and door coupling version
- Switch disconnectors in metal enclosure
- Changeover switches in metal enclosure.



Page 12-36

GE SERIES 50A TO 1600A (AC21A)

- IEC version three and four-pole switch disconnectors
- IEC version three and four-pole switch disconnectors with NFC, NH and BS type fuse holders
- Switch disconnectors with direct operating handle and door coupling version
- Three and four-pole changeover switches; add-on motorised control unit available.



Page 12-44

GM SERIES 30A TO 800A (AC21A)

- UL98 certified three-pole switch disconnectors with CC, J and L type fuse holders
- Switch disconnectors with fuse holders direct operating and door coupling versions.



Page 12-46

FOR PHOTOVOLTAIC APPLICATIONS UP TO 850A 1000VDC (DC21B)

- Switch disconnectors
- Direct operating and door coupling versions
- Switch disconnectors in non-metallic enclosure
- Connection of 2, 3, 4 poles in series.

GA series
16A to 160A



	DIRECT OPERATING HANDLE AND DOOR COUPLING VERSION											DOOR MOUNT VERSION										
	36mm/1.42" width					70mm/2.75" width						36mm/1.42" width					70mm/2.75" width					
AC21A (IEC/EN/BS)	16A	25A	32A	40A	63A	30A	63A	80A	100A	125A	160A	16A	25A	32A	40A	63A	30A	63A	80A	100A	125A	160A
GENERAL USE 600VAC (UL/CSA)	16A	25A	32A	40A	60A	30A	60A	100A	100A	100A	-	16A	25A	32A	40A	-	30A	60A	100A	100A	100A	-
SWITCH DISCONNECTORS																						
Certifications	UL60947-4-1																					
	UL98																					
Three-pole	●	●	●	●	●	●	●	●	●	●	●	●	●	●	●	●	●	●	●	●	●	●
4th pole - simultaneous closing		●			●	●	●	●	●	●	●		●				●	●	●	●	●	●
4th pole - early make		●			●			●					●						●			
Fuse holder 10x38mm		●																				
Fuse holder 10x38mm type CC	●																					
Mechanical 6-8 pole coupling system			●					●														
Mechanical interlock for line switching			●					●														
ASSEMBLED CHANGEOVER SWITCHING																						
Three-pole IEC/EN/BS		●		●	●			●		●	●											
Four-pole IEC/EN/BS		●		●	●			●		●	●											



	PLASTIC ENCLOSED VERSION WITH RED/YELLOW OR BLACK HANDLE										METAL ENCLOSED VERSION WITH RED/YELLOW OR BLACK HANDLE									
	AC21A (IEC/EN/BS)	16A	25A	32A	40A	63A	63A	80A	100A	125A	160A	16A	25A	32A	40A	63A	63A	80A	100A	125A
GENERAL USE 600VAC (UL/CSA)	16A	25A	32A	40A	60A	60A	100A	100A	100A	-	-	-	-	-	-	-	-	-	-	-
SWITCH DISCONNECTORS																				
Three-pole IEC/EN/BS	●	●	●	●	●	●	●	●	●	●	●	●	●	●	●	●	●	●	●	●
Four-pole IEC/EN/BS	●		●	●	●	●		●	●	●	●		●	●	●	●		●	●	●
Three-pole UL 60947-4-1	●	●	●	●	●															
Three-pole UL98						●	●	●	●											
Four-pole UL 60947-4-1	●		●																	
Four-pole UL98						●		●												
CHANGEOVER SWITCHING																				
Three-pole IEC/EN/BS												●		●	●		●		●	●
Four-pole IEC/EN/BS												●		●	●		●		●	●
Three-pole UL 60947-4-1		●		●	●															
Three-pole UL98							●		●											
Four-pole UL 60947-4-1		●		●	●															
Four-pole UL98							●		●											



	STAINLESS STEEL AISI 304 ENCLOSED VERSION WITH RED/YELLOW OR BLACK HANDLE						
AC21A (IEC/EN/BS)	16A	25A	32A	40A	63A	63A	100A
SWITCH DISCONNECTORS							
Three-pole IEC/EN/BS	●	●	●	●	●	●	●

GL series 160A to 630A



	DIRECT OPERATING HANDLE AND DOOR COUPLING VERSION									METAL ENCLOSED VERSION WITH RED/YELLOW OR BLACK HANDLE			
AC21A (IEC/EN/BS)	160A	200A	200A	250A	315A	320A	400A	500A	630A	160A	200A	250A	315A
GENERAL USE 600VAC (UL/CSA)	-	100A	200A	-	-	-	400A	-	-	-	-	-	-
SWITCH DISCONNECTORS													
Three-pole IEC/EN/BS	●		●	●	●	●	●	●	●	●	●	●	●
Three-pole UL98		●	●				●						
4th pole - simultaneous closing					●					●	●	●	●
CHANGEOVER SWITCHES													
Three and four-pole IEC/EN/BS	●		●	●	●	●	●	●	●	●	●	●	●
Three and four-pole UL1008		●	●				●						

GE series 50A to 1600A



	DIRECT OPERATING AND DOOR COUPLING VERSION																
AC21A (IEC/EN/BS)	50A	125A	160A	200A	250A	315A	400A	500A	630A	800A	1000A	1250A	1600A	2000A	2500A	3150A	
SWITCH DISCONNECTORS 50A...1600A																	
Three and four-pole			●	●	●	●	●	●	●	●	●	●	●				
Three and four-pole with NFC fuse holder	●	●															
Three and four-pole with NH fuse holder			●	●			●		●	●							
Three and four-pole with BS fuse holder			●	●	●	●	●		●	●							
Four-pole for photovoltaic applications		●			●	●			●	●		●					
CHANGEOVER SWITCHES 160A...3150A																	
Three and four-pole			●	●	●	●	●	●	●	●	●	●	●	●	●	●	●
Motorised control unit			●			●			●			●	●	●	●	●	

GM series 30A to 800A



	DIRECT OPERATING AND DOOR COUPLING VERSION						
GENERAL USE 600VAC (UL/CSA)	30A	60A	100A	200A	400A	600A	800A
DISCONNECT SWITCHES WITH FUSE HOLDERS 30A...800A							
UL98 three-pole disconnect switches with CC type fuse holders	●						
UL98 three-pole disconnect switches with J type fuse holders	●	●	●	●	●	●	
UL98 three-pole disconnect switches with L type fuse holders							●

For photovoltaic applications



	DIRECT OPERATING AND DOOR COUPLING VERSION										PLASTIC ENCLOSED VERSION WITH RED/YELLOW OR BLACK HANDLE		
CONVENTIONAL THERMAL CURRENT I _{th} DC21B (800V)	15A	25A	32A	40A	125A	250A	280A	600A	630A	1000A	25A	32A	40A
Switch disconnectors GA series	●												
Switch disconnectors GD series		●	●	●							●	●	●
Four-pole switch disconnectors GE series				●	●	●	●	●	●	●			

Summary table of combinations - Switch disconnectors

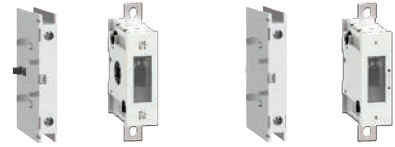

Type		IEC conventional free air thermal current I _{th} AC21A (≤690V)	IEC rated operational current I _e			General purpose current (UL)	Max 3-phase horse-power rating (UL)	IEC reactive power for control of capacitors 400V	Fourth pole		Neutral terminal			
Direct operating or door coupling	Door mounting		AC23A (400V)	AC23A (500V)	AC23A (690V)				Direct operating or door coupling	Door mounting	Direct operating or door coupling	Door mounting		
Order code	Order code	[A]	[A]	[A]	[A]	[A]	[HP/V]	[kvar]	Order code	Order code	Order code	Order code		
IEC/EN/BS and UL60947-4-1 three-pole switch disconnectors.														
GA016A	GA016C	16	16	16	16	16	5/240 10/480 10/600	7.5	GAX42040A GAX41040A	GAX42040C GAX41040C	GAX31A	GAX31C		
GA025A	GA025C	25	25	25	25	25	7.5/240 15/480 20/600	10						
GA032A	GA032C	32	32	25	25	32	10/240 20/480 20/600	12.5						
GA040A	GA040C	40	40	25	25	40	15/240 20/480 25/600	15						
GA063SA	GA063SC	63	45	25	25	60	15/240 30/480 32/600	15					GAX42063SA GAX41063SA	GAX42063SC
IEC/EN/BS and UL98 three-pole switch disconnectors.														
GA030A	GA030C	30	30	30	30	30	10/240 20/480 30/600	12.5	GAX42063A GAX41125A	GAX42063C GAX41125C	GAX32A	GAX32C		
GA063A	GA063C	63	63	63	47	60	20/240 40/480 40/600	25						
GA080A	GA080C	80	80	63	47	100	25/240 40/480 40/600	30					GAX42080A GAX41125A	GAX42080C GAX41125C
GA100A	GA100C	100	100	80	47	100	30/240 50/480 50/600	40					GAX42100A GAX41125A	GAX42100C GAX41125C
GA125A	GA125C	125	125	100	47	100	30/240 60/480 60/600	50					GAX42125A GAX41125A	GAX42125C GAX41125C
IEC/EN/BS three-pole switch disconnectors.														
GA160A	GA160C	160	125	100	47	–	–	50	GAX42160A	GAX42160C	GAX32A	GAX32C		
GL0160C1	–	160	160	160	160	–	–	80	GLX420315	–	GLX300	–		
GL0200C1	–	200	200	200	200	–	–	100	–	–	–	–		
GL0250C1	–	250	250	250	250	–	–	115	–	–	–	–		
GL0315C1	–	315	315	–	–	–	–	145	–	–	–	–		
GL0320C1	–	320	320	320	320	–	–	145	GLX420320	–	GLX302	–		
GL0400C1	–	400	400	400	400	–	–	180	GLX420400	–	–	–		
GL0500C1	–	500	500	500	500	–	–	200	GLX420500	–	–	–		
GL0630C1	–	630	630	500	–	–	–	200	GLX420630	–	–	–		
UL98 three-pole switch disconnectors.														
GL0100C1UL	–	160	160	160	160	100	30/240 75/480 100/600	–	GLX420100UL	–	GLX300	–		
GL0200C1UL	–	200	200	200	200	200	75/240 150/480 200/600	–	GLX420200UL	–	–	–		
GL0400C1UL	–	400	400	400	400	400	125/240 250/480 350/600	–	GLX420400UL	–	GLX302	–		

12 Switch disconnectors



Earth/ground terminal		Direct operating handle		Door coupling handle		Shaft extensions for door coupling handles	Auxiliary contacts	Terminal covers	Phase barriers	Terminal clamps	Captive nuts
Direct operating or door coupling	Door mounting	Black	Red/Yellow	Black	Red/Yellow						
Order code	Order code	Order code	Order code	Order code	Order code	Order code	Order code	Order code	Order code	Order code	Order code

<u>GAX33A</u>	<u>GAX33C</u>	<u>GAX61B</u> <u>GAX62B</u> <u>GAX63B</u> <u>GAX63KB</u> <u>GAX631B</u> <u>GAX632B</u> <u>GAX64B</u> <u>GAX68B</u>	<u>GAX61</u> <u>GAX62</u> <u>GAX63</u> <u>GAX63K</u> <u>GAX632</u> <u>GAX64</u> <u>GAX68</u>	<u>GAX61B</u> <u>GAX62B</u> <u>GAX63B</u> <u>GAX63KB</u> <u>GAX631B</u> <u>GAX632B</u> <u>GAX64B</u> <u>GAX68B</u>	<u>GAX61</u> <u>GAX62</u> <u>GAX63</u> <u>GAX63K</u> <u>GAX632</u> <u>GAX64</u> <u>GAX68</u>	<u>GAX7055</u> <u>GAX7070</u> <u>GAX7090</u> <u>GAX7150</u> <u>GAX7200</u> <u>GAX7300</u> <u>GAX7400</u> <u>GAX7500</u>	<u>GAX1011A</u> <u>GAX1020A</u> <u>GAX1110EA</u>	<u>GAX83</u> <u>GAX81</u>	-	-	-
---------------	---------------	---	--	---	--	--	--	------------------------------	---	---	---





<u>GAX34A</u>	<u>GAX34C</u>	<u>GAX61B</u> <u>GAX62B</u> <u>GAX63B</u> <u>GAX63KB</u> <u>GAX631B</u> <u>GAX632B</u> <u>GAX64B</u> <u>GAX66NB</u> <u>GAX68B</u>	<u>GAX61</u> <u>GAX62</u> <u>GAX63</u> <u>GAX63K</u> <u>GAX632</u> <u>GAX64</u> <u>GAX66N</u> <u>GAX68</u>	<u>GAX61B</u> <u>GAX62B</u> <u>GAX63B</u> <u>GAX63KB</u> <u>GAX631B</u> <u>GAX632B</u> <u>GAX64B</u> <u>GAX66NB</u> <u>GAX68B</u>	<u>GAX61</u> <u>GAX62</u> <u>GAX63</u> <u>GAX63K</u> <u>GAX632</u> <u>GAX64</u> <u>GAX66N</u> <u>GAX68</u>	<u>GAX7055</u> <u>GAX7070</u> <u>GAX7090</u> <u>GAX7150</u> <u>GAX7200</u> <u>GAX7300</u> <u>GAX7400</u> <u>GAX7500</u> <u>GAX7150AN</u> <u>GAX7200AN</u> <u>GAX7300AN</u> <u>GAX7400AN</u> <u>GAX7500AN</u>	<u>GAX1011A</u> <u>GAX1020A</u> <u>GAX1210EA</u>	<u>GAX84</u> <u>GAX82</u>	-	-	-
---------------	---------------	---	---	---	---	--	--	------------------------------	---	---	---

<u>GAX34A</u>	<u>GAX34C</u>	<u>GAX61B</u> <u>GAX62B</u> <u>GAX63B</u> <u>GAX63KB</u> <u>GAX631B</u> <u>GAX632B</u> <u>GAX64B</u> <u>GAX66NB</u> <u>GAX68B</u>	<u>GAX61</u> <u>GAX62</u> <u>GAX63</u> <u>GAX63K</u> <u>GAX632</u> <u>GAX64</u> <u>GAX66N</u> <u>GAX68</u>	<u>GAX61B</u> <u>GAX62B</u> <u>GAX63B</u> <u>GAX63KB</u> <u>GAX631B</u> <u>GAX632B</u> <u>GAX64B</u> <u>GAX66NB</u> <u>GAX68B</u>	<u>GAX61</u> <u>GAX62</u> <u>GAX63</u> <u>GAX63K</u> <u>GAX632</u> <u>GAX64</u> <u>GAX66N</u> <u>GAX68</u>	<u>GAX7055</u> <u>GAX7070</u> <u>GAX7090</u> <u>GAX7150...</u> <u>GAX7200...</u> <u>GAX7300...</u> <u>GAX7400...</u> <u>GAX7500...</u>	<u>GAX1011A</u> <u>GAX1020A</u> <u>GAX1210EA</u>	<u>GAX84</u> <u>GAX82</u>	-	-	-
---------------	---------------	---	---	---	---	---	--	------------------------------	---	---	---

<u>GLX301</u>	-	<u>GLX61DB</u>	<u>GLX61D</u>	<u>GLX61B</u>	<u>GLX61</u>	<u>GLX7150S10</u> <u>GLX7200S10</u> <u>GLX7300S10</u> <u>GLX7400S10</u> <u>GLX7500S10</u>	<u>GLX1001</u> <u>GLX1001EA</u>	<u>GLX800</u> <u>GLX801</u>	<u>GLX900</u> <u>GLX901</u>	<u>GLX500</u> <u>GLX501</u>	<u>GLX550</u>
<u>GLX303</u>	-	<u>GLX62DB</u>	<u>GLX62D</u>	<u>GLX62B</u>	<u>GLX62</u>			<u>GLX802</u> <u>GLX803</u>	<u>GLX902</u> <u>GLX903</u>	<u>GLX502</u> <u>GLX503</u> <u>GLX504</u> <u>GLX505</u>	<u>GLX551</u>

<u>GLX301</u>	-	<u>GLX61DB</u>	<u>GLX61D</u>	<u>GLX61B</u>	<u>GLX61</u>	<u>GLX7150S10</u> <u>GLX7200S10</u> <u>GLX7300S10</u> <u>GLX7400S10</u> <u>GLX7500S10</u>	<u>GLX1001</u> <u>GLX1001EA</u>	<u>GLX800</u> <u>GLX801</u>	<u>GLX900</u> <u>GLX901</u>	<u>GLX500</u> <u>GLX501</u>	<u>GLX550</u>
<u>GLX303</u>	-	<u>GLX62DB</u>	<u>GLX62D</u>	<u>GLX62B</u>	<u>GLX62</u>			<u>GLX802</u> <u>GLX803</u>	<u>GLX902</u> <u>GLX903</u>	<u>GLX502</u> <u>GLX503</u> <u>GLX504</u> <u>GLX505</u>	<u>GLX551</u>

Summary table of combinations - Changeover switches

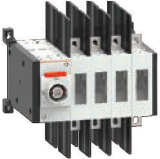
Order code	IEC conventional free air thermal current I _{th} AC21A (≤690V)	IEC rated operational current I _e			General purpose current (UL) [A]	Max 3-phase horsepower rating (UL) [HP/V]	
	[A]	AC23A (400V) [A]	AC23A (500V) [A]	AC23A (690V) [A]			
IEC/EN/BS three-pole changeover switches.							
	GA025ET6	25	25	25	25	-	-
	GA040ET6	40	40	25	25		
	GA063SAET6	63	45	25	25		
	GA080ET6	80	80	63	47		
	GA125ET6	125	125	100	47		
	GA160ET6	160	125	100	47		
	GLC0160C1	160	160	160	160		
	GLC0200C1	200	200	200	200		
	GLC0250C1	250	250	250	250		
	GLC0315C1	315	315	250	250		
	GLC0320C1	320	320	320	320		
	GLC0400C1	400	400	400	400		
	GLC0500C1	500	500	500	500		
	GLC0630C1	630	630	500	500		
							
IEC/EN/BS four-pole changeover switches.							
	GA025ET8	25	25	25	25	-	-
	GA040ET8	40	40	25	25		
	GA063SAET8	63	45	25	25		
	GA080ET8	80	80	63	47		
	GA125ET8	125	125	100	47		
	GA160ET8	160	125	100	57		
	GLC0160T4C1	160	160	160	160		
	GLC0200T4C1	200	200	200	200		
	GLC0250T4C1	250	250	250	250		
	GLC0315T4C1	315	315	250	250		
	GLC0320T4C1	320	320	320	320		
	GLC0400T4C1	400	400	400	400		
	GLC0500T4C1	500	500	500	500		
	GLC0630T4C1	630	630	500	500		
							
UL1008 three-pole changeover switches.							
	GLC0100C1UL	160	160	160	160	100	30/240 75/480 100/600
	GLC0200C1UL	200	200	200	200	200	75/240 150/480 200/600
	GLC0400C1UL	400	400	400	400	400	125/240 250/480 350/600
							
UL1008 four-pole changeover switches.							
	GLC0100T4C1UL	160	160	160	160	100	30/240 75/480 100/600
	GLC0200T4C1UL	200	200	200	200	200	75/240 150/480 200/600
	GLC0400T4C1UL	400	400	400	400	400	125/240 250/480 350/600
							

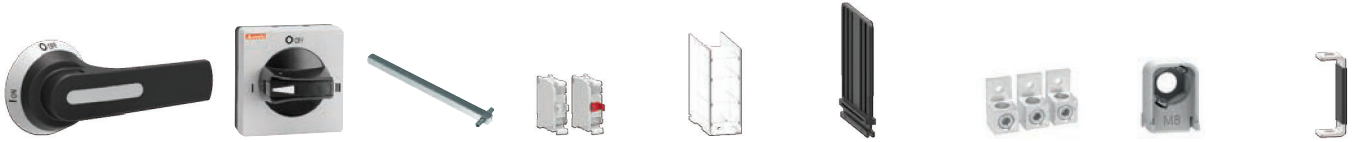

	Direct operating handle	Door coupling handle	Shaft extensions for door coupling handles	Auxiliary contacts	Terminal covers	Phase barriers	Terminal claps	Captive nuts	Parallel connections
	Order code	Order code	Order code	Order code	Order code	Order code	Order code		
	Built-in GAX5000	GAX67B	GAX7055 GAX7070 GAX7090 GAX7150 GAX7200 GAX7300 GAX7400 GAX7500	GAX1011A GAX1020A GAX1110EA	GAX83 GAX81	-	-	-	-
	Built-in GAX5001			GAX1011A GAX1020A GAX1110EA	GAX84 GAX82				
	GLX61DB	GLX61CB	GLX7150S10 GLX7200S10 GLX7300S10 GLX7400S10 GLX7500S10	GLX1001 GLX1010EA	GLX800 GLX801	GLX900 GLX901	GLX500 GLX501	GLX550	GLX201 GLX202
	GLX62DB	GLX62CB			GLX802 GLX803	GLX902 GLX903	GLX502 GLX503 GLX504 GLX505	GLX551	GLX206 GLX207
	Built-in GAX5000	GAX67B	GAX7055 GAX7070 GAX7090 GAX7150 GAX7200 GAX7300 GAX7400 GAX7500	GAX1011A GAX1020A GAX1110EA	GAX83 GAX81	-	-	-	-
	Built-in GAX5001			GAX1011A GAX1020A GAX1110EA	GAX84 GAX82				
	GLX61DB	GLX61CB	GLX7150S10 GLX7200S10 GLX7300S10 GLX7400S10 GLX7500S10	GLX1001 GLX1010EA	GLX800 GLX801	GLX900 GLX901	GLX500 GLX501	GLX550	GLX201 GLX202
	GLX62DB	GLX62CB			GLX802 GLX803	GLX902 GLX903	GLX502 GLX503 GLX504 GLX505	GLX551	GLX206 GLX207
	GLX61DB	GLX61B	GLX7150S10 GLX7200S10 GLX7300S10 GLX7400S10 GLX7500S10	GLX1001 GLX1010EA	GLX800 GLX801	GLX900 GLX901	GLX500 GLX501	GLX550	GLX201 GLX202
	GLX62DB	GLX62B			GLX802 GLX803	GLX902 GLX903	GLX502 GLX503 GLX504 GLX505	GLX551	GLX206 GLX207
	GLX61DB	GLX61B	GLX7150S10 GLX7200S10 GLX7300S10 GLX7400S10 GLX7500S10	GLX1001 GLX1010EA	GLX800 GLX801	GLX900 GLX901	GLX500 GLX501	GLX550	GLX201 GLX202
	GLX62DB	GLX62B			GLX802 GLX803	GLX902 GLX903	GLX502 GLX503 GLX504 GLX505	GLX551	GLX206 GLX207

VERSATILITY!

COMPACT SIZE

The three-pole 16A to 63A switch disconnectors, are made up of a single unit body, merely 36mm/1.42" wide, while the 30A to 160A ratings, of another frame size of only 70mm/2.75" wide.

ACCESSORY FLEXIBILITY

Mounting and removal of the fourth pole and add-on blocks are simple and quick operations with no need for tools.

VERSIONS FOR PHOTOVOLTAIC APPLICATIONS

The GA... series switch disconnectors are suitable for small domestic installations as well as those with a large number of solar cells. Use up to 800V in DC21B category.



CERTIFICATIONS

The 16A to 63A types are listed for the USA and Canada, certified according to UL60947-4-1/CSA C22.2 n° 60947-4-1. The 30A to 125A types are listed for Canada and the USA, certified according to UL98A/CSA C22.2 n° 4.



SIDE MOUNT ADD-ON FOURTH POLE

Simultaneous closing or early-make contact operation of the fourth pole with respect to the switch disconnector poles.



ADD-ON AUXILIARY CONTACTS

Only one add-on block suitable for all the 9 ratings of switch disconnectors, having simultaneous closing with the switch disconnector poles. There are versions with an early-break NO contact with respect to the switch disconnector.

MAXIMUM COMBINATIONS

Mounting up to 4 auxiliary contacts or 1 fourth pole and 3 auxiliary contacts (2 blocks always on the right and 2 on the left side) of each switch disconnector. The earth and neutral terminals and fuse holder also can be added.



SWITCH STATUS INDICATION

The switch open or closed state is clearly and unequivocally seen at a distance thanks to the simple and modern design of the handles.

TERMINAL ADAPTABILITY

Terminals are suitable to accept any type of cable: flexible, rigid, AWG wire. The terminals can withstand high tightening torques.

6 AND 8 POLE VERSION

Mechanical coupling systems are available for switch disconnectors with direct operating handle to provide 6/8 pole disconnectors or a mechanical interlock mechanism for the line changeover function (I - O - II). The enclosed switches are cULus certified.



FUSE HOLDERS



A three-pole fuse holder can be added to 16A to 32A switch disconnectors, with direct operating handle, to provide a single compact unit. Access to the fuse can be made only when the disconnector is in OFF position.

HIGH IEC CAPABILITY IN AC23

The rated currents I_n in AC23 at 690VAC are the highest of the category.

TORX SCREW TERMINALS

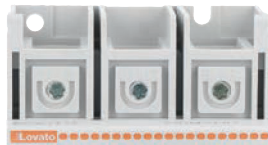

Version with Torx screw terminals available on request.

MODULARITY

The switch disconnectors can be mounted in modular panels.

IP65 PADLOCKABLE HANDLES

Wide range of selector or pistol grip handles, with screw or ring fixing. All handles are equipped with built-in padlockable mechanism. The selector handle GAX63... snaps onto the door mount switch disconnectors in 16A to 40A ratings, with no need for tools.



DIN RAIL FIXING

Switch disconnector mounting on and removal from the 35mm DIN rail are done by simply pressing it downwards with no need for tools.

ANTI-SLIDE INSERT FOR DIN RAIL

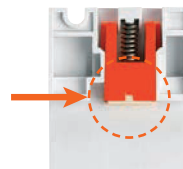

A rubber pad insert prevents the sliding of switch disconnectors on the DIN rail even when out of tolerance or mounted vertically.

DOOR COUPLING HANDLE WITH FRONT DIMENSIONS 48X48MM

The GAX68 and GAX68B handles can be used in panels and boxes of limited dimensions.



REDUCED HANDLE THICKNESS

GAX61 and GAX61B handles are only 23mm thick.

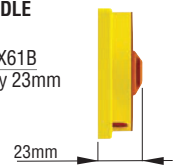

HANDLE IP69K (GAX63K and GAX63KB)



HANDLE ADAPTABILITY

The extensive number of fixing holes in the front handle plate can replace switch disconnectors, normally found out in the field, without having to drill others.



UL508A HANDLE VERSION

In compliance with UL508A standards, which require internal panel inspection by authorised personnel with power applied, selector and pistol handles are available with defeatable feature of the door coupling when the switch disconnector is closed, i.e. in ON position.



Three-pole switch disconnectors with direct operating handle and door coupling version



GA016A...
GA040A
GA063SA



GA030A
GA063A...
GA160A

Order code	IEC conventional free air thermal current Ith AC21A (≤690V)	IEC rated operational current Ie AC22A (≤690V) AC23A (≤400V)	Qty per pkg	Wt
	[A]	[A]	n°	[kg]

Direct operating version, complete with black handle. For door coupling version, separately purchase the handle and shaft extension (see pages 12-14 and 12-16). According to UL60947-4-1.

GA016A	16	16	1	0.146
GA025A	25	25	1	0.146
GA032A	32	32	1	0.146
GA040A	40	40	1	0.146
GA063SA	63	45	1	0.148

According to UL98.

GA030A	30	30	1	0.388
GA063A	63	63	1	0.388
GA080A	80	80	1	0.388
GA100A	100	100	1	0.388
GA125A	125	125	1	0.388

According to IEC.

GA160A	160	125	1	0.388
--------	-----	-----	---	-------

Direct operating version, complete with yellow/red handle. For door coupling version, separately purchase the handle and shaft extension (see pages 12-14 and 12-16).



GA0... ARY



GA063...ARY

GA016ARY	16	16	1	0.146
GA025ARY	25	25	1	0.146
GA032ARY	32	32	1	0.146
GA040ARY	40	40	1	0.146
GA063SARY	63	45	1	0.148
GA030ARY	30	30	1	0.388
GA063ARY	63	63	1	0.388
GA080ARY	80	80	1	0.388
GA100ARY	100	100	1	0.388
GA125ARY	125	125	1	0.388

According to IEC.

GA160ARY	160	125	1	0.388
----------	-----	-----	---	-------

new

Fourth pole add-on



GAX42...A
GAX41...A
GAX42063SA
GAX41063SA

Order code	IEC conventional free air thermal current Ith AC21A (≤690V)	IEC rated operational current Ie AC22A (≤690V) AC23A (≤400V)	Qty per pack	Wt
	[A]	[A]	n°	[kg]

Simultaneous closing operation as switch disconnector poles. For GA...A... version.

GAX42040A①	40	40	1	0.045
GAX42063SA②	63	45	1	0.045
GAX42063SA③	63	63	1	0.126
GAX42080A	80	80	1	0.126
GAX42100A	100	100	1	0.126
GAX42125A	125	125	1	0.126
GAX42160A	160	125	1	0.126

Early make closing operation with respect to switch disconnector poles. For GA...A... version.

GAX41040A④	40	40	1	0.046
GAX41063SA②	63	45	1	0.046
GAX41125A④	125	125	1	0.116

- ① For GA016A...GA040A... only.
- ② For GA063SA... only.
- ③ For GA030A... and GA063A... only.
- ④ For GA030A... and GA063A...GA125A... only.

General characteristics

- 16A to 160A
- Available versions:
 - Direct operating
 - Door coupling. Use switch disconnector with direct operating handle and separately purchase the handle and shaft extension for this version. See pages 12-14 and 12-16
- Version with Torx screw terminals available on request
- Compact and modular size
- Screw or 35mm DIN rail fixing
- Padlockable in 0 position with no extra accessory.

Operational characteristics

- Rated insulation voltage Ui: 1000V
- Rated impulse withstand Uimp: 8kV
- Electrical life in AC21A:
 - 100,000 cycles GA016...GA040..., GAX...40A
 - 15,000 cycles GA063SA..., GAX...063SA
 - 30,000 cycles GA030... and GA063...GA125..., GAX...063...125A
 - 1,500 cycles GA160A..., GAX42160A
- Mechanical life:
 - 100,000 cycles GA016...GA040A..., GA063SA..., GAX...40A, GAX...063SA
 - 30,000 cycles GA030... and GA063...GA160A..., GAX...063...125A, GAX42160A.

Certifications and compliance

Certifications obtained:

Type	cULus according to UL60947-4-1 / CSA C22.2 n°60947-4-1	cULus according to UL98 / CSA C22.2 n°4	EAC	KEWA
GA016A...GA040A	●	—	●	●
GA063SA	●	—	●	—
GA030A and GA063A...GA125A...	—	●	●	—
GA160A...-GAX42160A	—	—	●	—
GAX41040A-GAX42040A	●	—	●	—
GAX41063SA-GAX42063SA	●	—	●	—
GAX41125A	—	●	●	—
GAX42063A...GAX42125A	—	●	●	—

● Certification obtained.

Compliant with standards: IEC/EN/BS 60947-3, IEC/EN/BS 60947-1, UL60947-4-1, UL98, CSA C22.2.

Strokes of GA...A... poles (main poles and add-on pole)

	Travel 0→1	0°	30°	60°	90°
GA016A...GA040A... - GA063SA... Main poles				60°	
GAX42040A - GAX42063SA Simultaneous closing fourth-pole add on				60°	
GAX41040A - GAX41063SA Early-make fourth-pole add on				55°	
GA063A...GA125A... GA160A... Main poles				55°	
GAX42063A...GAX42125A GAX42160A Simultaneous closing fourth-pole add on				55°	
GAX41125A Early-make fourth-pole add on				48°	
	OFF				ON

Three-pole switch disconnectors

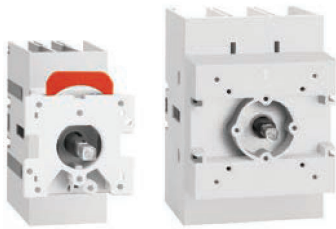

GA016C...
GA040C
GA063SC

GA063C...
GA160C

new

Order code	IEC conventional free air thermal current Ith AC21A (≤690V)	IEC rated operational current Ie AC22A (≤690V) AC23A (≤400V)	Qty per pkg	Wt
	[A]	[A]	n°	[kg]

Door mount version, complete with shaft extension (purchase handle separately, see page 12-14). According to UL60947-4-1.

GA016C	16	16	1	0.170
GA025C	25	25	1	0.170
GA032C	32	32	1	0.170
GA040C	40	40	1	0.170

According to IEC.

GA063SC	63	40	1	0.170
----------------	----	----	---	-------

According to UL98.

GA030C	30	30	1	0.404
GA063C	63	63	1	0.404
GA080C	80	80	1	0.404
GA100C	100	100	1	0.404
GA125C	125	125	1	0.404

According to IEC.

new

GA160C	160	125	1	0.404
---------------	-----	-----	---	-------

Fourth pole add-on



GAX42040C
GAX41040C

new

Order code	IEC conventional free air thermal current Ith AC21A (≤690V)	IEC rated operational current Ie AC22A (≤690V) AC23A (≤400V)	Qty per pack	Wt
	[A]	[A]	n°	[kg]

Simultaneous closing operation as switch disconnector poles. For GA...C version.

GAX42040C ①	40	40	1	0.045
GAX42063SC	63	40	1	0.045
GAX42063C ②	63	63	1	0.128
GAX42080C	80	80	1	0.128
GAX42100C	100	100	1	0.128
GAX42125C	125	125	1	0.128
GAX42160C	160	125	1	0.128

Early make closing operation with respect to switch disconnector poles. For GA...C version.

GAX41040C ③	40	40	1	0.046
GAX41125C ③	125	125	1	0.128

- ① For GA016C...GA040C only.
- ② For GA030C and GA063C only.
- ③ For GA030C and GA063C...GA125C only.

new

General characteristics

- 16A to 160A
- Available versions:
 - Door mount
- Compact and modular size
- Padlockable in 0 position with no extra accessory.

Operational characteristics

- Rated insulation voltage Ui: 1000V
- Rated impulse withstand Uimp: 8kV
- Electrical life in AC21A:
 - 100,000 cycles GA016...GA040C, GAX...40C
 - 15,000 cycles GA063SC, GAX42063SC
 - 30,000 cycles GA030C and GA063...GA125C, GAX...063...125C
 - 1,500 cycles GA160C, GAX42160C
- Mechanical life:
 - 100,000 cycles GA016...GA040C..., GA063SC..., GAX...40C, GAX...063SC
 - 30,000 cycles GA030... and GA063...GA160C..., GAX...063...125C, GAX42160C.

Certifications and compliance

Certifications obtained:

Type	cULus according to UL60947-4-1 / CSA C22.2 n°60947-4-1	cULus according to UL98 / CSA C22.2 n°4	EAC	KEMA
GA016C...GA040C	●	—	●	●
GA030C and GA063C...GA125C	—	●	●	—
GAX41040C...GAX42040C	●	—	●	—
GAX42125C	—	●	●	—
GAX42063C...GAX42125C	—	●	●	—
GAX42160C	—	—	●	—

● Certification obtained.

Compliant with standards: IEC/EN 60947-3, IEC/EN 60947-1, UL60947-4-1, UL98, CSA C22.2.

Strokes of GA...C poles

(main poles and add-on pole)

	Travel 0→1	0°	30°	60°	90°
GA016C...GA040C - GA063SC Main poles				60°	
GAX42040C - GAX2063SC Simultaneous closing fourth-pole add on				60°	
GAX41040C Early-make fourth-pole add on				55°	
GA063C...GA125C Main poles				55°	
GAX42063C...GAX42160C Simultaneous closing fourth-pole add on				55°	
GAX41125C Early-make fourth-pole add on				48°	
	OFF				ON

12 Switch disconnectors

GA series 16A to 160A.
Accessories

Add-on blocks



GAX1011A
GAX1020A

GAX1011C



GAX1110EA
GAX1210EA



GAX3...A

GAX3...C



GAX50...



GAX60...

Order code	Characteristics	Qty per pack	Wt
		n°	[kg]

Auxiliary contacts, simultaneous closing as poles of switch disconnector.

GAX1011A	1NO + 1NC for GA...A..., and GA040D	1	0.030
GAX1020A	2NO for GA...A... and GA040D	1	0.030
GAX1011C	1NO + 1NC for GA...C	1	0.030

Auxiliary contacts, early-break operation with respect to poles of switch disconnector.

GAX1110EA	1EB(NO) for GA016A... GA040A..., GA063SA... and GA040D	1	0.035
GAX1210EA	1EB(NO) for GA030A... and GA063A...GA160A...	1	0.035

Neutral terminal.

GAX31A	For GA016A...GA040A..., GA063SA... and GA040D	1	0.040
GAX32A	For GA030A... and GA063A...GA160A...	1	0.110
GAX31C	For GA016C...GA040C and GA063SC	1	0.040
GAX32C	For GA030C and GA063C...GA160C	1	0.110

Earth/Ground terminal.

GAX33A	For GA016A...GA040A, GA063SA and GA...D	1	0.040
GAX34A	For GA030A and GA063A...GA160A	1	0.110
GAX33C	For GA016C...GA040C and GA063SC	1	0.040
GAX34C	For GA030C and GA063C...GA125C	1	0.110

Mechanical interlock for line changeover (I-O-II).

GAX5000	For GA016A...GA040A..., GA063SA..., GA040D and GAX67B; □ 5mm/0.2" ①	1	0.050
GAX5001	For GA030A..., GA063A...GA160A... and GAX67B; □ 5mm/0.2" ①	1	0.075

Mechanical coupling system for 6-8 pole switch disconnectors.

GAX6000	For GA016A...GA040A..., GA063SA... and GA040D; □ 5mm/0.2" ①	1	0.050
GAX6001	For GA030A... and GA063A...GA125A..., □ 7mm/0.3" ②③	1	0.075

- ① Use GAX7... shaft extensions.
- ② Use GAX66N... handles and GAX7...AN extensions for a door coupling version.
- ③ Cannot be used with GA160A...

Strokes of GA poles (main poles with auxiliary contacts)

	Travel 0→1	0°	30°	60°	90°
GA016A...GA040A... - GA063SA... Main poles				60°	
GAX1011A - GAX1011C Auxiliary contacts (1NO+1NC)				60°	
GAX1020A Auxiliary contacts (2NO)					
		40°			
GAX1110EA Auxiliary contact (1EB - NO early-break with respect to main poles)			Travel 0→1	60°	
			Travel 1→0	70°	
GA030A... and GA063A...GA125A..., GA160A Main poles				55°	
GAX1011A - GAX1011C Auxiliary contacts (1NO+1NC)				45°	
GAX1020A Auxiliary contacts (2NO)					
			25°		
GAX1210EA Auxiliary contact (1EB NO early-break with respect to main poles)			Travel 0→1	55°	
			Travel 1→0	65°	
	OFF				ON

Operational characteristics of auxiliary contacts

- Conventional free air thermal current I_{th}: 10A
- UL/CSA and IEC/EN/BS 60947-5-1 designation: A600-Q600
- Tightening torque: 0.8Nm/7.1lb.in.

Operational characteristics for other devices

- Tightening torque:
 - GAX31A/C-GAX33A/C terminals: 1.8...2Nm/16...18lb.in
 - GAX32A/C-GAX34A/C terminals: 5...6Nm/45...54lb.in
 - GAX5000/1-GAX6000/1 fixing: 0.5Nm/4.4lb.in; extension with handle: 0.8Nm/7.1lb.in.

Transformation of direct operating version into door coupling type:

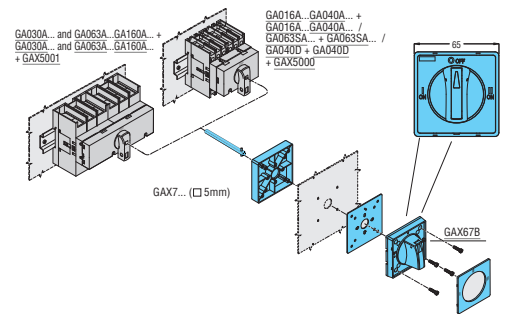

Certifications and compliance

Certifications obtained:

Type	cULus according to UL 60947-4-1 / CSA C22.2 n°14	cULus according to UL98 / CSA C22.2 n°4	EAC
GAX1011A - GAX1011C	●	—	●
GAX1110EA	●	—	●
GAX1210EA	—	●	●
GAX31A - GAX31C	●	—	●
GAX32A - GAX32C	—	●	●
GAX33A - GAX33C	●	—	●
GAX34A - GAX34C	—	●	●
GAX5000 - GAX6000	●	—	●
GAX5001 - GAX6001	—	●	●

● Certification obtained.

Compliant with standards: IEC/EN/BS 60947-1, IEC/EN/BS 60947-3, IEC/EN/BS 60947-5-1, UL 60947-4-1, UL98, CSA C22.2.

Strokes of GA...D types (main poles and auxiliary contacts)

	Travel 0→1	0°	30°	60°	90°
GA040D Main poles				60°	
GA042040D simultaneous closing fourth -pole add on				60°	
GAX1011A Auxiliary Contacts (1NO+1NC)				60°	
GAX1020A Auxiliary contacts (2NO)					
			40°		
GAX1110EA auxiliary contact (1EB NO early-break with respect to main poles)			Travel 0→1	60°	
			Travel 1→0	70°	

12 Switch disconnectors

GA series 16A to 160A.

Add-on block and accessories

Maximum combinations

GA016A...GA040A...GA040D Sequence and maximum combination of add-on blocks on direct operating switch disconnectors.

1	1	1	—	1	GA016A... GA025A... GA032A... GA040A... GA040D❶	—	—	2	1	1	
1	1	2	—	—		—	1	—	1	1	1
1	1	1	—	1		—	—	1	1	1	1
1	1	1	1	—		—	1	—	1	1	1
1	1	1	1	—		—	—	—	2	1	1
1	1	2	—	—		—	—	1	1	1	1
1	1	2	—	—		—	—	—	2	1	1
1	1	—	—	—		—	1	—	—	1	1
1	1	—	—	1		—	—	—	—	1	1
1	1	—	—	—		—	—	—	—	1	1

❶ GAX42040D can be used with GA040D switch only.

GA063SA...

1	1	1	—	1	GA063SA...	—	—	2	1	1	
1	1	2	—	—		—	1	—	1	1	1
1	1	1	—	1		—	—	1	1	1	1
1	1	1	1	—		—	1	—	1	1	1
1	1	1	1	—		—	—	—	2	1	1
1	1	2	—	—		—	—	1	1	1	1
1	1	2	—	—		—	—	—	2	1	1
1	1	—	—	—		—	1	—	—	1	1
1	1	—	—	1		—	—	—	—	1	1
1	1	—	—	—		—	—	—	—	1	1

GA030A... and GA063A...GA160A...

—	—	1	—	1	GA030A... GA063A... GA080A... GA100A... GA125A... GA160A...❶	—	—	2	—	—	
—	—	2	—	—		—	1	—	1	—	—
—	—	1	—	1		—	—	1	1	—	—
—	—	1	1	—		—	1	—	1	—	—
—	—	2	—	—		—	—	—	2	—	—
—	—	2	—	—		—	—	—	1	—	—
1	1	—	—	—		—	1	—	—	1	1
1	1	—	—	1		—	—	—	—	1	1
1	1	—	—	—		—	—	—	—	1	1
1	1	—	—	—		—	—	—	—	1	1

❶ GA160A... can be fitted with 1 single 4th pole (GAX42160A) on one side and an auxiliary contact on the other.

GA016C...GA040C and GA063C Sequence and maximum combination of add-on blocks on door mount switch disconnectors.

1	1	1	1	GA016C GA025C GA032C GA040C GA063C	—	—	1	1	1	
1	1	1	—		—	1	—	1	1	1
1	1	—	1		—	—	1	—	1	1
1	1	1	—		—	1	—	—	1	1
1	1	1	—		—	—	—	1	1	1
1	1	—	—		—	—	—	—	1	1

GA030C and GA063C...GA160C

—	—	1	1	GA030C GA063C GA080C GA100C GA125C GA160C	—	1	—	—	—	
—	—	1	—		—	1	—	—	—	—
1	1	—	1		—	—	—	—	—	—
—	—	1	—		—	1	—	—	1	1
—	—	1	—		—	—	1	—	—	—
1	1	—	—		—	—	—	—	1	1

12 Switch disconnectors

GA series 16A to 160A.
Add-on block and accessories

Maximum combinations

GA016A...GA040A... GA040D + GAX5000 - GAX6000 Sequence and maximum combination for mechanical coupling and mechanical interlock for line changeover.

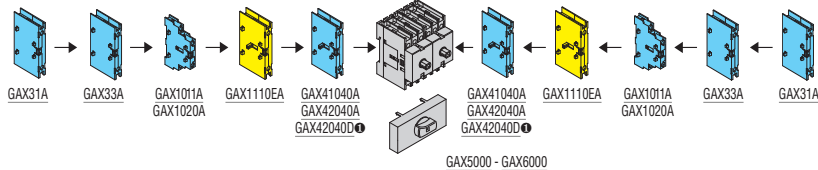

1	1	1	—	1		1	—	1	1	1
1	1	1	—	1	GA016A ... + GA016A ...	—	—	2	1	1
1	1	2	—	—	GA025A... + GA025A...	1	—	1	1	1
1	1	1	—	1	GA032A... + GA032A...	—	1	1	1	1
1	1	1	1	—	GA032A... + GA032A...	1	—	1	1	1
1	1	1	1	—	GA040A... + GA040A...	—	—	2	1	1
1	1	2	—	—	GA040A... + GA040A...	—	1	1	1	1
1	1	2	—	—	GA040D + GA040D ①	—	—	2	1	1
1	1	—	—	1	GA040D + GA040D ①	1	—	—	1	1
1	1	—	—	—		—	—	—	1	1

① GAX42040D can be used with GA040D switch only.

GA063SA... + GAX5000 - GAX6000

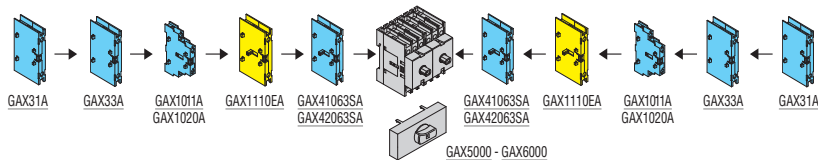

1	1	1	—	1		1	—	1	1	1
1	1	1	—	1	GA063SA... + GA063SA...	—	—	2	1	1
1	1	2	—	—	GA063SA... + GA063SA...	1	—	1	1	1
1	1	1	—	1	GA063SA... + GA063SA...	—	1	1	1	1
1	1	1	1	—	GA063SA... + GA063SA...	1	—	1	1	1
1	1	1	1	—	GA063SA... + GA063SA...	—	—	2	1	1
1	1	2	—	—	GA063SA... + GA063SA...	—	1	1	1	1
1	1	2	—	—	GA063SA... + GA063SA...	—	—	2	1	1
1	1	—	—	1	GA063SA... + GA063SA...	1	—	—	1	1
1	1	—	—	—	GA063SA... + GA063SA...	—	—	—	1	1

GA030A... and GA063A...GA160A... + GAX5001 - GAX6001

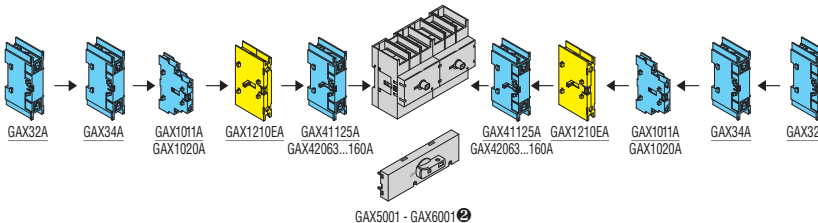

—	—	1	—	1	GA030A... + GA030A...	1	—	1	—	—
—	—	1	—	1	GA030A... + GA030A...	—	—	2	—	—
—	—	2	—	—	GA063A... + GA063A...	1	—	1	—	—
—	—	1	—	1	GA080A... + GA080A...	—	1	1	—	—
—	—	1	1	—	GA080A... + GA080A...	1	—	1	—	—
—	—	1	1	—	GA100A... + GA100A...	—	—	2	—	—
—	—	2	—	—	GA100A... + GA100A...	—	1	1	—	—
—	—	2	—	—	GA125A... + GA125A...	—	—	2	—	—
1	1	—	—	1	GA160A... + GA160A... ①	1	—	—	1	1
1	1	—	—	—	GA160A... + GA160A... ①	—	—	—	1	1

① GA160A... can be fitted with a single auxiliary contact (GAX1011A or GAX1020A) per side.

② Cannot be used with GA160A...

12 Switch disconnectors

GA series 16A to 160A.
Accessories

Handles



GAX61



GAX63



new

GAX66N



GAX68

- ❶ For GA...A..., GA040D and GD... switch disconnectors, separately purchase extension GAX7...
- ❷ Snap-on fixing of GA016C...GA040C and GA063SC switch disconnectors with the handle.
- ❸ Separately purchase GAX7...AN shaft extension and GAX60B adaptor.

Order code	Characteristics	Qty	Wt
		per pkg	[kg]
		no.	
DOOR COUPLING VERSION PADLOCKABLE, IP65 (4X). Red/yellow.			
GAX61	For GA...A..., GA063SA..., GA...C, GA040D and GD... Screw fixing. Handle with selector flush-mounted ❶. □ 5mm/0.2"	1	0.073
GAX62	For GA...A..., GA063SA..., GA...C, GA040D and GD... Screw fixing. Handle with selector protruding ❶. □ 5mm/0.2"	1	0.072
GAX63	For GA...A..., GA063SA..., GA016C...GA040C and GA063SC, GA040D and GD... Ring fixing. Handle with selector protruding ❶❷. □ 5mm/0.2"	1	0.068
GAX63K	For GA...A..., GA063SA..., GA016C...GA040C and GA063SC, GA040D and GD... Ring fixing. Handle with selector protruding ❶❷. □ 5mm/0.2" IP69K	1	0.068
GAX632	For GA...A..., GA063SA..., GA040D and GD... Ring fixing low profile. Handle with selector protruding. □ 5mm/0.2" ❶	1	0.057
GAX64	For GA...A..., GA063SA..., GA040D and GD... Ring fixing. Handle with selector protruding - defeatable (requirement UL508A)❸. □ 5mm/0.2"	1	0.064
GAX66N	For GA030A..., GA063A...GA160A..., and GAX6001. Screw fixing. Pistol handle - defeatable (req. UL 508A)❸. □ 7mm/0.3"	1	0.140
GAX68	For GA016A...GA063SA..., GA040D, GA016C...GA040 C, GD and GA063SC. Screw fixing. Handle with selector lowered ❶. □ 5mm/0.2"	1	0.060

General and operational characteristics

- Choice of handle fixing: ring or screw
- Handle fixing centres:
 - GAX61/61B-GAX62/62B-GAX67B: 36x36mm/1.42x1.42" or 48x48mm/1.89x1.89"
 - GAX66N/66NB: 28x40mm/1.10x1.57"
 - GAX68/68B: 28x28mm/1.10x1.10" or 36x36mm/1.42x1.42"
- Compatible with pre-existing drillings of most common types in the marketplace
- 1 to 3 padlocks in the Ø4...8mm/0.16...0.31" for all handles except:
 - GAX68 only 1 padlock in the Ø4...8mm/0.16...0.31"
 - GAX61 up to 3 padlocks in the Ø5...8mm/0.20...0.31"
- Front plate dimensions:
 - GAX61/61B-GAX62/62B-GAX63/63B-GAX64/64B-GAX67/67B: 65x65mm/2.56x2.56"
 - GAX66N/66NB: Ø76mm/2.99"
 - GAX68/68B: 48x48mm/1.89x1.89"
- Tightening torque:
 - Fixing ring types: 2.3Nm/20.4lb.in
 - GAX60B: 0.8Nm/7lb.in
 - GAX66N/66NB: 1.5Nm/13.3lb.in
 - All others: 0.8Nm/7lb.in
- Degree of protection for all: IP65
- Degree of protection for GAX66N/66NB: IP66, IP69K; for UL/CSA data see detail on page 12-16.

Certifications and compliance

See the table on page 12-16.

From direct operating version to door coupling version.

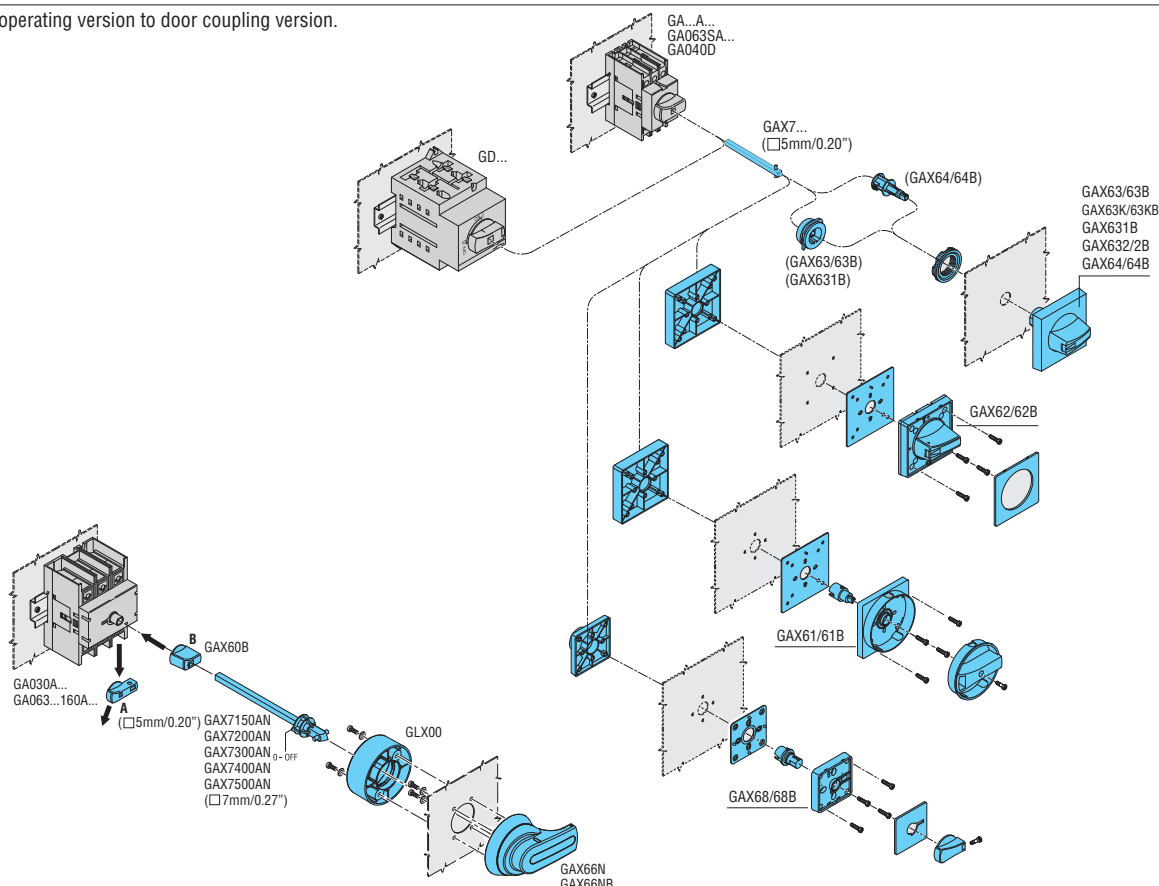

12 Switch disconnectors

GA series 16A to 160A.
Accessories

Handles



GAX61B



GAX63...B



GAX632B



GAX67B

new

- ① For GA...A..., GA040D and GD... switch disconnectors, separately purchase extension GAX7...
- ② Snap-on fixing of GA016C...GA040C and GA063SC switch disconnectors with the handle.
- ③ Separately purchase GAX7...AN shaft extension and GAX60B adaptor.

Order code	Characteristics	Qty per pkg	Wt
		no.	[kg]
Black.			
GAX61B	For GA...A..., GA063SA..., GA...C, GA040D and GD... Screw fixing. Handle with selector flush-mounted ①. □ 5mm/0.2"	1	0,073
GAX62B	For GA...A..., GA063SA..., GA...C, GA040D and GD... Screw fixing. Handle with selector protruding ①. □ 5mm/0.2"	1	0,072
GAX63B	For GA...A..., GA063SA..., GA016C...GA040C and GA063SC, GA040D and GD... Ring fixing. Handle with selector protruding ①②. □ 5mm/0.2"	1	0,068
GAX63KB	For GA...A..., GA063SA..., GA016C...GA040C, GA040D, GD... and GA063SC. Ring fixing. Handle with selector protruding ①②. □ 5mm/0.2". IP69K	1	0,068
GAX631B	For GA...A..., GA063SA..., GA016C...GA040C and GA063SC, GA040D and GD... Ring fixing. Handle with selector protruding padlockable in ON pos. (UNI 9490 and UNI EN 12845) ①②. □ 5mm/0.2"	1	0,074
GAX632B	For GA...A..., GA063SA..., GA040D and GD... Ring fixing low profile. Handle with selector protruding. □ 5mm/0.2" ①	1	0,057
GAX64B	For GA...A..., GA063SA..., GA040D and GD... Ring fixing. Handle with selector protruding - defeatable (requir.UL508A) ①. □ 5mm/0.2"	1	0,064
GAX66NB	For GA030A..., GA063A...GA160A... and GAX6001. Screw fixing. Pistol handle - defeatable (req. UL 508A) ③. □ 7mm/0.3"	1	0,140
GAX67B	For mechanical interlock GAX50... (I-O-II) ①. □ 5mm/0.2"	1	0,078
GAX68B	For GA016A...GA063SA..., GA040D, GA016C...GA040C, GA063SC and GD... Screw fixing. Handle with selector lowered ①. □ 5mm/0.2"	1	0,060

General and operational characteristics

- Choice of handle fixing: ring or screw
- Handle fixing centres:
 - GAX61/61B-GAX62/62B-GAX67B: 36x36mm/1.42x1.42" or 48x48mm/1.89x1.89"
 - GAX66N/66NB: 28x40mm/1.10x1.57"
 - GAX68/68B: 28x28mm/1.10x1.10" or 36x36mm/1.42x1.42"
 - Compatible with pre-existing drillings of most common types in the marketplace
- 1 to 3 padlocks in the Ø4...8mm/0.16...0.31" for all handles except:
 - GAX68 only 1 padlock in the Ø4...8mm/0.16...0.31"
 - GAX61 up to 3 padlocks in the Ø5...8mm/0.20...0.31"
- Front plate dimensions:
 - GAX61/61B-GAX62/62B-GAX63/63B-GAX64/64B-GAX67/67B: 65x65mm/2.56x2.56"
 - GAX66N/66NB: Ø76mm/2.99"
 - GAX68/68B: 48x48mm/1.89x1.89"
- Tightening torque:
 - Fixing ring types: 2.3Nm/20.4lb.in
 - GAX60B: 0.8Nm/7lb.in
 - GAX66N/66NB: 1.5Nm/13.3lb.in
 - All others: 0.8Nm/7lb.in
- Degree of protection for all: IP65
- Degree of protection for GAX66N/66NB: IP66, IP69K; for UL/CSA data see detail on page 12-16.

Certifications and compliance

See the table on page 12-16.

Door mount version.

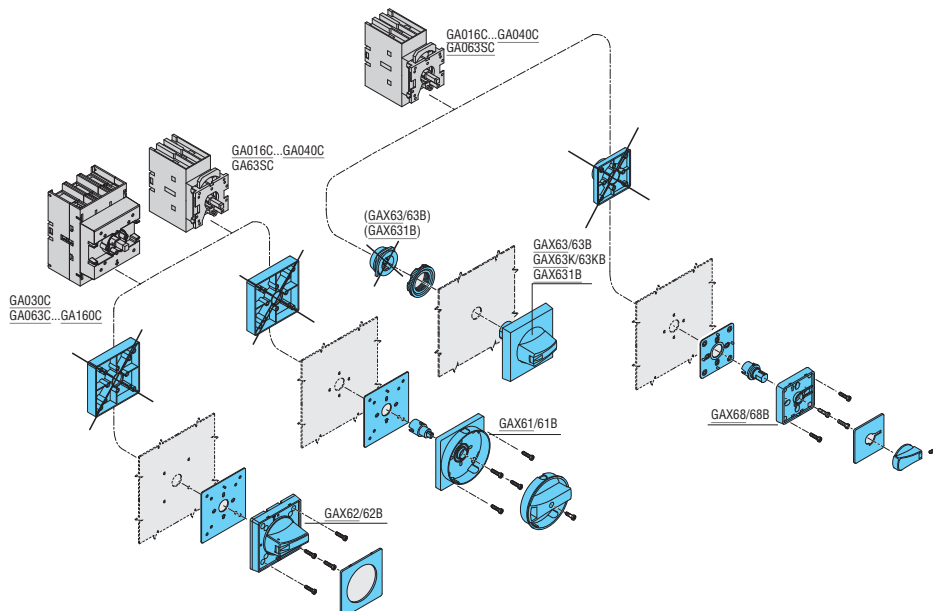

12 Switch disconnectors

GA series 16A to 160A.
Accessories

Shaft extensions
Terminal covers
Fuse holders/blocks



GAX7...



GAX7... AN



GAX18S0...

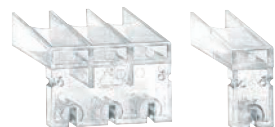

GAX8...



GAX391

Order code	Characteristics	Qty per pkg	Wt
		n°	[kg]

Shaft extension for door coupling handles GAX61...GAX64, GAX68, GAX61B...GAX64B, GAX67B, GAX68B and mechanical interlock type GAX5000, GAX5001 and mechanical coupling GAX6000 ①.

GAX7055	55mm/2.16" long □ 5mm/0.2"	1	0.012
GAX7070	70mm/2.75" long □ 5mm/0.2"	1	0.014
GAX7090	90mm/3.54" long □ 5mm/0.2"	1	0.018
GAX7150	150mm/5.90" long □ 5mm/0.2"	1	0.032
GAX7200	200mm/7.87" long □ 5mm/0.2"	1	0.070
GAX7300	300mm/11.81" long □ 5mm/0.2"	1	0.068
GAX7400	400mm/15.75" long □ 5mm/0.2"	1	0.072
GAX7500	500mm/19.68" long □ 5mm/0.2"	1	0.090

Shaft extension for door coupling handles GAX66N, GAX66NB and mechanical coupling system GAX6001.

GAX7150AN	150mm/5.90" long □ 7mm/0.3"	1	0.090
GAX7200AN	200mm/7.87" long □ 7mm/0.3"	1	0.112
GAX7300AN	300mm/11.81" long □ 7mm/0.3"	1	0.160
GAX7400AN	400mm/15.74" long □ 7mm/0.3"	1	0.200
GAX7500AN	500mm/19.68" long □ 7mm/0.3"	1	0.250

Adaptor for GAX66N and GAX66NB handles.

GAX60B	Adaptor □ 7mm/0.3" for GA030A...GA160A...	1	0.010
---------------	---	---	-------

Accessory for shaft extension.

GLX00	Shaft alignment ring	1	0.040
--------------	----------------------	---	-------

Support for shaft extension.

GAX18S05	□ 5mm/0.2"	1	0.160
GAX18S07	□ 7mm/0.27"	1	0.160

Set of 2 one-pole terminal covers for fourth pole.

GAX81	For GAX42040A, GAX42063SA, GAX42063SC, GAX42040C, GAX42040D, GAX41040A, GAX41040C and GAX41063SA	1	0.009
GAX82	For GAX42063A...GAX42160A, GAX42063C...GAX42160C, GAX41125A and GAX41125C	1	0.012

Set of 2 three-pole terminal covers.

GAX83	For GA016A...GA040A..., GA063SA..., GA016C...GA063C, GA063SC and GA040D	1	0.011
GAX84	For GA030A...GA160A..., GA030C...GA160C	1	0.030

Fuse holder for switch disconnectors.

GAX391	For GA016A...GA032A... Suitable for 10.3x38 fuse size	1	0.132
GAX391UL	For GA016A...GA025A... Suitable for Class CC fuses	1	0.135

① Other length available on request.

Operational characteristics of fuse holder

- IEC rated insulation voltage Ui: 1000V
- IEC rated impulse withstand Uimp: 8kV
- The fuse holder/blocks connects directly to the switch disconnectors
- Access to fuses only when the switch disconnectors are in OFF position.

Terminal covers

For switch disconnectors

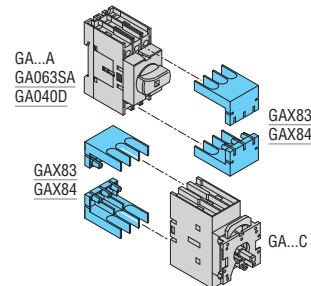

For fourth pole

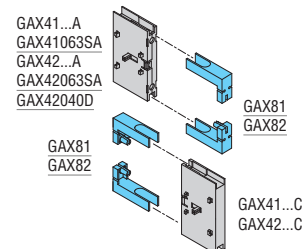

Certifications and compliance

Certifications obtained:

Type	cULus according to UL60947-4-1 / CSA C22.2 n°60947-4-1	cULus according to UL98 / CSA C22.2 n°4	EAC
GAX61-GAX61B	●	●	●
GAX62-GAX62B	●	●	●
GAX63-GAX63B	●	●	●
GAX631B	—	—	●
GAX632-GAX632B	●	●	●
GAX64-GAX64B	●	●	●
GAX66N-GAX66NB	—	●	●
GAX67B	●	●	●
GAX68-GAX68B	●	—	●
GAX60B	—	●	●
GAX7055...GAX7500	●	●	●
GAX7150AN...GAX7300AN	—	●	●
GAX81-GAX83	●	—	●
GAX82-GAX84	—	●	●
GAX391	—	—	●
GAX391UL	●	—	—

● Certification obtained.

NOTE: types GAX61/61B, GAX62/62B, GAX63/63B, GAX632/2B, GAX64/64B, GAX68/68B, GX67 are UL/CSA Type 1, 2, 3R, 12, 12K, 4, 4X external use when used with types GA016...40A/C, GA040D and GA063SA. GAX61/61B, GAX62/62B, GAX63/63B, GAX632/2B, GAX64/64B, GAX66/66B, GX67 are UL/CSA Type 1, 3R, 12, 12K, 4, 4X external use when used with types GA030A/C and GA063...GA125A/C.

Compliant with standards: IEC/EN/BS 60947-1, IEC/EN/BS 60947-3, UL60947-4-1, UL98, CSA C22.2.

Assembled changeover switches



GA025...063...ET6

new

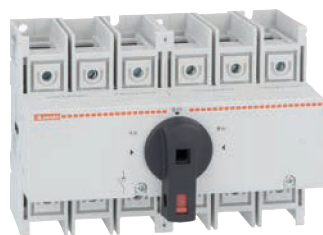

GA080...160ET6

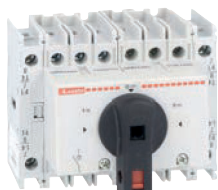

GA025...063...ET8

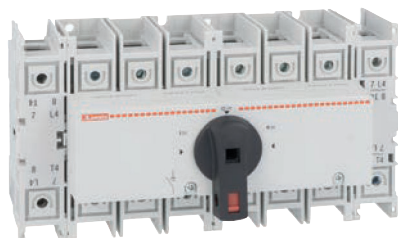

GA080...160ET8

Order code	IEC conventional thermal current I _{th} AC21A (≤690V)	IEC rated operational current I _e AC22A (≤690V) AC23A (≤400V)	Qty per pkg	Wt
	[A]	[A]	n°	[kg]

Three-pole versions.

GA025ET6	25	25	1	0.350
GA040ET6	40	40	1	0.350
GA063SAET6	63	45	1	0.350
GA080ET6	80	80	1	0.881
GA125ET6	125	125	1	0.881
GA160ET6	160	125	1	0.881

Four-pole versions.

GA025ET8	25	25	1	1.250
GA040ET8	40	40	1	1.250
GA063SAET8	63	45	1	1.250
GA080ET8	80	80	1	1.133
GA125ET8	125	125	1	1.133
GA160ET8	160	125	1	1.133

Components

Switch disconnector	Fourth pole	Mechanical interlock
2 x GA025A	-	GAX5000
2 x GA040A	-	GAX5000
2 x GA063SA	-	GAX5000
2 x GA080A	-	GAX5001
2 x GA125A	-	GAX5001
2 x GA160A	-	GAX5001

2 x GA025A	2 x GAX42040A	GAX5000
2 x GA040A	2 x GAX42040A	GAX5000
2 x GA063SA	2 x GAX42063SA	GAX5000
2 x GA080A	2 x GAX42080A	GAX5001
2 x GA125A	2 x GAX42125A	GAX5001
2 x GA160A	2 x GAX42160A	GAX5001

Switch disconnectors complete with shaft extension, door-coupling handle and terminal covers



new

GA...A...K...

Order code	IEC conventional thermal current I _{th} AC21A (≤690V)	IEC rated operational current I _e AC22A (≤690V) AC23A (≤400V)	Poles	Qty per pkg	Wt
	[A]	[A]	n°	n°	[kg]

Three-pole versions.

GA025AK30063	25	25	3P	1	0.302
GA040AK30063	40	40	3P	1	0.302
GA063SAK30063	63	45	3P	1	0.302

Four-pole versions.

GA025AK30063T4	25	25	4P	1	0.356
GA040AK30063T4	40	40	4P	1	0.356
GA063SAK30063T4	63	45	4P	1	0.356

Components

Switch disconnector	Fourth pole	Terminal cover	
		3P	1P
GA025A	-	GAX83	-
GA040A	-	GAX83	-
GA063SA	-	GAX83	-

GA025A	GAX42040A	GAX83	GAX81
GA040A	GAX42040A	GAX83	GAX81
GA063SA	GAX42063SA	GAX83	GAX81

- 300mm shaft extension: GAX7300
- Red/yellow door-coupling handle: GAX63
- 2 pcs-set of terminal covers for both line and load terminals protection.

12 Switch disconnectors

GA series 16A to 160A

Empty plastic enclosures IEC/EN IP65 type



GAZ1

GAZ2



GAZ3



GAX30

Order code	Description	Qty per pkg	Wt
		n°	[kg]

For switch disconnectors.
With red/yellow handle. Complete with shaft extension.

GAZ1	For GA016A...GA040A.../D	1	0.320
GAZ2	For GA063SA..., GA030A... and GA063A...GA100A...	1	0.780
GAZ3	For GA125A...GA160A...	1	1.900

With black handle. Complete with shaft extension.

GAZ1B	For GA016A...GA040A.../D	1	0.320
GAZ2B	For GA063SA..., GA030A... and GA063A...GA100A	1	0.730
GAZ3B	For GA125A...GA160A...	1	1.900

Accessory.

GAX30	Shielded cable fixing kit for GAZ1 and GAZ1B	1	0.083
--------------	--	---	-------

The empty enclosures are supplied with the following accessories:

Enclosure	GAZ1 GAZ1B	GAZ2 GAZ2B	GAZ3 GAZ3B
Red/yellow handle	GAX61	GAX61	GAX61
Black handle	GAX61B	GAX61B	GAX61B
Extension	1	1	1
Neutral plate terminal	1	1	-
Earth/Ground plate terminal	1	1	-

General characteristics

- Enclosure material: ABS
- Padlockable handles
- Sealable cover
- Tightening torque for cover screws:
 - GAZ1...: 1.3Nm/16lb.in
 - GAZ2... and GAZ3...: 1.5Nm/13lb.in
- Degree of protection: IP65
- Cable entry:
 - GAZ1... types: PG16/M25 and PG13.5/M20 knockouts
 - GAZ2... types: PG16/M25 and PG29/M32 knockouts
 - GAZ3... types: smooth surfaces; can be drilled by customer.

Certifications and compliance

Certifications obtained: EAC.
Compliant with standards: IEC/EN/BS 60947-3, IEC/EN/BS 60947-1.

Empty plastic enclosures UL/CSA Type 4/4X



GAZ1UL



GAZ2UL



GAX30

Order code	Description	Qty per pkg	Wt
		no.	[kg]

For switch disconnectors.
With red/yellow handle. Complete with shaft extension.

GAZ1UL	For GA016A...GA040A... and GA040D	1	0.320
GAZ2UL	For GA063SA...	1	0.730

With black handle. Complete with shaft extension.

GAZ1BUL	For GA016A...GA040A... and GA040D	1	0.320
GAZ2BUL	For GA063SA...	1	0.730

Accessory.

GAX30	Shielded cable fixing kit for GAZ1UL and GAZ1BUL	1	0.083
--------------	--	---	-------

The empty enclosures are supplied with the following accessories:

Enclosure	GAZ1UL GAZ1BUL	GAZ2UL GAZ2BUL
Red/yellow handle	GAX61	GAX61
Black handle	GAX61B	GAX61B
Extension	1	1
Neutral plate terminal	1	1
Earth/Ground plate terminal	1	1

General characteristics

- Enclosure material: polycarbonate
- Padlockable handles
- Sealable cover
- Tightening torque for cover screws:
 - GAZ1...UL: 1.3Nm/16lb.in
 - GAZ2...UL: 1.5Nm/13lb.in
- Degree of protection: IP65; UL/CSA Type 4/4X
- Cable entry:
 - GAZ1...UL types: PG16/M25 and PG13.5/M20 knockouts
 - GAZ2...UL types: PG16/M25 and PG29/M32 knockouts.

Certifications and compliance

Certifications obtained: cULus for GAZ1...UL and GAZ2...UL types; EAC for all.
Compliant with standards: IEC/EN/BS 60947-3, IEC/EN/BS 60947-1, UL60947-4-1 and CSA C22.2 n°60947-4-1.

12 Switch disconnectors

GA series 16A to 160A.

Switch disconnectors in plastic enclosure

IEC/EN IP65 in plastic enclosure



GAZ016...GAZ040...



GAZ063...100C



GAZ125... GAZ160...

Order code	IEC conventional thermal current Ith	IEC rated operational current Ie		Qty per pkg	Wt [kg]
	AC21A (≤690V)	AC23B (≤400V)	AC23B (≤500V)		
	[A]	[A]	[A]	n°	

THREE-POLE.
With red/yellow handle.

GAZ016	16	16	16	1	0.450
GAZ025	25	25	25	1	0.450
GAZ032	32	32	25	1	0.450
GAZ040	40	40	25	1	0.450
GAZ063SA	63	45	25	1	0.870
GAZ063C	63	63	63	1	1.220
GAZ080C	80	80	63	1	1.220
GAZ100C	100	100	80	1	1.220
GAZ125	125	125	100	1	2.220
GAZ160	160	125	100	1	2.220

THREE-POLE.
With black handle.

GAZ016B	16	16	16	1	0.450
GAZ025B	25	25	25	1	0.450
GAZ032B	32	32	25	1	0.450
GAZ040B	40	40	25	1	0.450
GAZ063SAB	63	45	25	1	0.870
GAZ063CB	63	63	63	1	1.220
GAZ080CB	80	80	63	1	1.220
GAZ100CB	100	100	80	1	1.220
GAZ125B	125	125	100	1	2.220
GAZ160B	160	125	100	1	2.220

FOUR-POLE.
With red/yellow handle.

GAZ016T4	16	16	16	1	0.550
GAZ032T4	32	32	25	1	0.550
GAZ040T4	40	40	25	1	0.550
GAZ063SAT4	63	45	25	1	0.780
GAZ063CT4	63	63	63	1	1.250
GAZ100CT4	100	100	80	1	1.250
GAZ125T4	125	125	100	1	2.500
GAZ160T4	160	125	100	1	2.500

FOUR-POLE.
With black handle.

GAZ016T4B	16	16	16	1	0.550
GAZ032T4B	32	32	25	1	0.550
GAZ040T4B	40	40	25	1	0.550
GAZ063SAT4B	63	45	25	1	0.780
GAZ063CT4B	63	63	63	1	1.250
GAZ100CT4B	100	100	80	1	1.250
GAZ125T4B	125	125	100	1	2.500
GAZ160T4B	160	125	100	1	2.500

General characteristics

- Enclosure material: ABS
- For four-pole types not indicated, separately purchase corresponding fourth pole GAX42...A and install on enclosed 3-pole version
- Possible accessories to mount afterwards, if any required:
 - GAX30 to provide shielded cable connection continuity (e.g. with static converters)
 - GAZ016...GAZ040...: 1 contact block both on the right and left disconnector side unless 4th pole is installed
 - Other types: 2 contact blocks both on the right and left disconnector side unless 4th pole is installed
 - GAZ125...GAZ160...: if any earth/ground and/or neutral terminal required, separately purchase types GAX3... given on page 12-11.
- Padlockable handles
- Sealable cover

Components

Enclosure	Switch disconnector	Handle included with GAZ...
GAZ1	GA016A	GAX61
GAZ1	GA025A	GAX61
GAZ1	GA032A	GAX61
GAZ1	GA040A	GAX61
GAZ2	GA063SA	GAX61
GAZ2	GA063A	GAX61
GAZ2	GA080A	GAX61
GAZ2	GA100A	GAX61
GAZ3	GA125A	GAX61
GAZ3	GA160A	GAX61

GAZ1B	GA016A	GAX61B
GAZ1B	GA025A	GAX61B
GAZ1B	GA032A	GAX61B
GAZ1B	GA040A	GAX61B
GAZ2B	GA063SA	GAX61B
GAZ2B	GA063A	GAX61B
GAZ2B	GA080A	GAX61B
GAZ2B	GA100A	GAX61B
GAZ3B	GA125A	GAX61B
GAZ3B	GA160A	GAX61B

Enclosure	Switch disconnector	4th pole	Handle
GAZ1	GA016A	GAX42040A	GAX61
GAZ1	GA032A	GAX42040A	GAX61
GAZ1	GA040A	GAX42040A	GAX61
GAZ2	GA063SA	GAX42063SA	GAX61
GAZ2	GA063A	GAX42063A	GAX61
GAZ2	GA100A	GAX42100A	GAX61
GAZ3	GA125A	GAX42125A	GAX61
GAZ3	GA160A	GAX42160A	GAX61

GAZ1B	GA016A	GAX42040A	GAX61B
GAZ1B	GA032A	GAX42040A	GAX61B
GAZ1B	GA040A	GAX42040A	GAX61B
GAZ2B	GA063SA	GAX42063SA	GAX61B
GAZ2B	GA063A	GAX42063A	GAX61B
GAZ2B	GA100A	GAX42100A	GAX61B
GAZ3B	GA125A	GAX42125A	GAX61B
GAZ3B	GA160A	GAX42160A	GAX61B

- Tightening torque for cover screws:
 - GAZ016...GAZ040...: 1.3Nm/16lb.in
 - Other types: 1.5Nm/13lb.in
- Degree of protection: IP65
- Cable entry:
 - GAZ016..., GAZ040... types: PG16/M25 and PG13.5/M20 knockouts
 - GAZ063SA...GAZ100... types: PG16/M25 and PG29/M32 knockouts
 - GAZ125..., GAZ160... types: smooth surfaces; can be drilled by customer.

Certifications and compliance

Certifications obtained: cULus (not for GAZ160), EAC.
Compliant with standards: IEC/EN/BS 60947-3, IEC/EN/BS 60947-1.

12 Switch disconnectors

GA series 16A to 125A.

Switch disconnectors in plastic enclosure

UL/CSA, Type 4/4X in plastic enclosure



GAZ016...GAZ040...UL



GAZ063SAUL



GAZ063UL - GAZ125UL

Order code	IEC conventional thermal current I _{th} AC21A (≤690V)	IEC rated operational current I _e AC23B (≤400V) AC23B (≤500V)		Qty per pkg	Wt [kg]
	[A]	[A]	[A]		

THREE-POLE.
With red/yellow handle.

GAZ016UL	16	16	16	1	0.450
GAZ025UL	25	25	25	1	0.450
GAZ032UL	32	32	25	1	0.450
GAZ040UL	40	40	25	1	0.450
GAZ063SAUL	63	45	25	1	0.870
GAZ063UL	63	63	63	1	1.220
GAZ080UL	80	80	63	1	2.220
GAZ100UL	100	100	80	1	2.220
GAZ125UL	125	125	100	1	2.220

THREE-POLE.
With black handle.

GAZ016BUL	16	16	16	1	0.450
GAZ025BUL	25	25	25	1	0.450
GAZ032BUL	32	32	25	1	0.450
GAZ040BUL	40	40	25	1	0.450
GAZ063SABUL	63	45	25	1	0.870
GAZ063BUL	63	63	63	1	1.220
GAZ080BUL	80	80	63	1	2.220
GAZ100BUL	100	100	80	1	2.220
GAZ125BUL	125	125	100	1	2.220

FOUR-POLE.
With red/yellow handle.

GAZ016T4UL	16	16	16	1	0.550
GAZ032T4UL	32	32	25	1	0.550
GAZ063T4UL	63	63	63	1	1.150
GAZ100T4UL	100	100	80	1	2.500
GAZ125T4UL	125	125	100	1	2.500

FOUR-POLE.
With black handle.

GAZ016T4BUL	16	16	16	1	0.550
GAZ032T4BUL	32	32	25	1	0.550
GAZ063T4BUL	63	63	63	1	1.150
GAZ100T4BUL	100	100	80	1	2.500
GAZ125T4BUL	125	125	100	1	2.500

General characteristics

- Enclosure material: polycarbonate
- For four-pole types not indicated, separately purchase corresponding fourth pole GAX4...A and install on enclosed 3-pole UL-suffix version
- Possible accessories to mount afterwards, if any required:
 - GAX30 to provide shielded cable connection continuity (e.g. with static converters)
 - GAZ016...GAZ040...: 1 contact block both on the right and left disconnector side unless 4th pole is installed
 - Other types: 2 contact blocks both on the right and left disconnector side unless 4th pole is installed
- Padlockable handles
- Sealable cover
- Tightening torque for cover screws:
 - GAZ016...GAZ040...UL: 1.3Nm/16lb.in
 - Other types: 1.5Nm/13lb.in

Components

Enclosure	Switch disconnector	Handle included with GAZ...
-----------	---------------------	-----------------------------

GAZ1UL	GA016A	GAX61
GAZ1UL	GA025A	GAX61
GAZ1UL	GA032A	GAX61
GAZ1UL	GA040A	GAX61
GAZ2UL	GA063SA	GAX61
GAZ3 ①	GA063A	GAX61
GAZ3 ①	GA080A	GAX61
GAZ3 ①	GA100A	GAX61
GAZ3 ①	GA125A	GAX61

GAZ1BUL	GA016A	GAX61B
GAZ1BUL	GA025A	GAX61B
GAZ1BUL	GA032A	GAX61B
GAZ1BUL	GA040A	GAX61B
GAZ2BUL	GA063SA	GAX61B
GAZ3B ①	GA063A	GAX61B
GAZ3B ①	GA080A	GAX61B
GAZ3B ①	GA100A	GAX61B
GAZ3B ①	GA125A	GAX61B

Enclosure	Switch disconnector	4th pole	Handle
GAZ1UL	GA016A	GAX42040A	GAX61
GAZ1UL	GA032A	GAX42040A	GAX61
GAZ3 ①	GA063A	GAX42063A	GAX61
GAZ3 ①	GA100A	GAX42100A	GAX61
GAZ3 ①	GA125A	GAX42125A	GAX61

GAZ1BUL	GA016A	GAX42040A	GAX61B
GAZ1BUL	GA032A	GAX42040A	GAX61B
GAZ3B ①	GA063A	GAX42063A	GAX61B
GAZ3B ①	GA100A	GAX42100A	GAX61B
GAZ3B ①	GA125A	GAX42125A	GAX61B

① For more details contact our Technical support; see contact details on inside front cover.

- Degree of protection: IP65; UL/CSA Type 4/4X
- Cable entry:
 - GAZ016...GAZ040...UL types: PG16/M25 and PG13.5/M20 knockouts
 - GAZ063SA...UL types: PG16/M25 and PG29/M32 knockouts
 - GAZ063...GAZ125...UL types: smooth surfaces; can be drilled by customer.

Certifications and compliance

Certifications obtained: cULus for GAZ016... GAZ125...UL, GAZ1...UL and GAZ2...UL types; EAC.
Compliant with standards: IEC/EN/BS 60947-3, IEC/EN/BS 60947-1, UL60947-4-1 and CSA C22.2 n°60947-4-1 (up to GAZ063SA...), UL98 and CSA C22.2 n°4 (for all others).

12 Switch disconnectors

GA series 16A to 160A.

Changeover switches in plastic enclosure

UL/CSA, Type 4/4X in plastic enclosure



GAZ025E...GAZ063SAE...



GAZ080E...
GAZ160E...

Order code	IEC conventional free air thermal current Ith		IEC rated operational current Ie		Qty per pkg	Wt [kg]
	AC21A (≤690V)	AC23B (≤400V)	AC23B (≤400V)	AC23B (≤500V)		
	[A]	[A]	[A]	n°		

3-pole line changeover switches I-O-II. Black handle.

GAZ025ET6	25	25	25	1	1.060
GAZ040ET6	40	40	25	1	1.060
GAZ063SAET6	63	45	25	1	1.070
GAZ080ET6	80	80	63	1	2.950
GAZ125ET6	125	125	100	1	2.950
GAZ160ET6	160	125	100	1	2.950

4-pole line changeover switches I-O-II. Black handle.

GAZ025ET8	25	25	25	1	1.060
GAZ040ET8	40	40	25	1	1.060
GAZ063SAET8	63	45	25	1	1.070
GAZ080ET8	80	80	63	1	2.950
GAZ125ET8	125	125	100	1	2.950
GAZ160ET8	160	125	100	1	2.950

UL/CSA ratings

Type	1 phase [HP]		3 phase [HP]				General use at 600VAC [A]	Short-circuit rating at 600VAC [kA]	Fuse class - max rating at 600V Type - [A]
	120V	240V	200-208V	240V	480V	600V			
GAZ016...	1	2	5	5	10	10	16	5	RK5 - 20A
GAZ025...	1½	3	7½	7½	15	20	25	5	RK5 - 30A
GAZ032...	2	5	10	10	20	20	32	5	RK5 - 35A
GAZ040...	2	5	10	15	20	25	40	5	RK5 - 45A
GAZ063S...	2	7½	10	15	30	30	60	5	RK5 - 45A

NOTE: Above ratings are valid for GAZ016 - GAZ063S...UL types, according to UL508 and CSA 22.2 n°14.

Type	1 phase [HP]		3 phase [HP]				General use at 600VAC [A]	Short-circuit rating at 600VAC [kA]	Max fuse rating at 600V [A]
	120V	240V	200-208V ^②	240V	480V	600V			
① GAZ063C...	3	7½	20	20	40	40	60	10	100
GAZ080...	3	10	25	25	40	40	100	10	100
GAZ100...	5	10	30	30	50	50	100	10	100
GAZ125...	7½	10	30	30	60	60	100	10	100

NOTE: Above ratings are valid for GAZ063C - GAZ125... types, according to UL98 and CSA C22.2 n°4.

① Lower ratings in this same UL/CSA category are available on specific request for volume orders.

For information, consult Technical support; see contact details on inside front cover.

② Voltage value not considered in UL98 / CSA 22.2 n°4 standards.

Components

Enclosure	Switch disconnectors	Mechanical interlock	Handle
GAZUL ^①	2x GA025A	GAX5000	GAX67B
GAZUL ^①	2x GA040A	GAX5000	GAX67B
GAZUL ^①	2x GA063SA	GAX5000	GAX67B
GAZ3 ^①	2x GA080A	GAX5001	GAX67B
GAZ3 ^①	2x GA125A	GAX5001	GAX67B
GAZ3 ^①	2x GA160A	GAX5001	GAX67B
Enclosure	Switch disconnectors	Mechanical interlock	Handle
GAZUL ^①	2x GA025A + 2x GAX42040A	GAX5000	GAX67B
GAZUL ^①	2x GA040A + 2x GAX42040A	GAX5000	GAX67B
GAZUL ^①	2x GA063SA + 2x GAX42063SA	GAX5000	GAX67B
GAZ3 ^①	2x GA080A + 2x GAX42080A	GAX5001	GAX67B
GAZ3 ^①	2x GA125A + 2x GAX42125A	GAX5001	GAX67B
GAZ3 ^①	2x GA160A + 2x GAX42160A	GAX5001	GAX67B

① For more details contact our Technical support; see contact details on inside front cover.

General characteristics

- Enclosure material: polycarbonate
- Possibility of fitting:
 - 2 contact blocks both on the right and left side for GAZ...ET6 types
 - 1 contact block both on the right and left side for GAZ...ET8 types
- Padlockable handle complete with extension
- Earth and neutral plate terminals
- Sealable enclosure cover
- Tightening torque for cover screws: 1.5Nm/13lb.in
- Degree of protection: IP65; UL/CSA Type 4/4X
- Cable entry:
 - GAZ025...GAZ063SA... types: PG16/M25 and PG29/M32 knockouts
 - GAZ080... and GAZ160... types: smooth surfaces; can be drilled by customer.

Certifications and compliance

Certifications obtained: cULus (except GAZ160E...), EAC. Compliant with standards: IEC/EN/BS 60947-3, IEC/EN/BS 60947-1, UL60947-4-1 and CSA C22.2 n°60947-4-1 (up to GAZ063SA...), UL98 and CSA C22.2 n°4 (for all others except GAZ160E...).

12 Switch disconnectors

GA series 16A to 160A.
Changeover switches in plastic enclosure

Maximum combination Enclosures

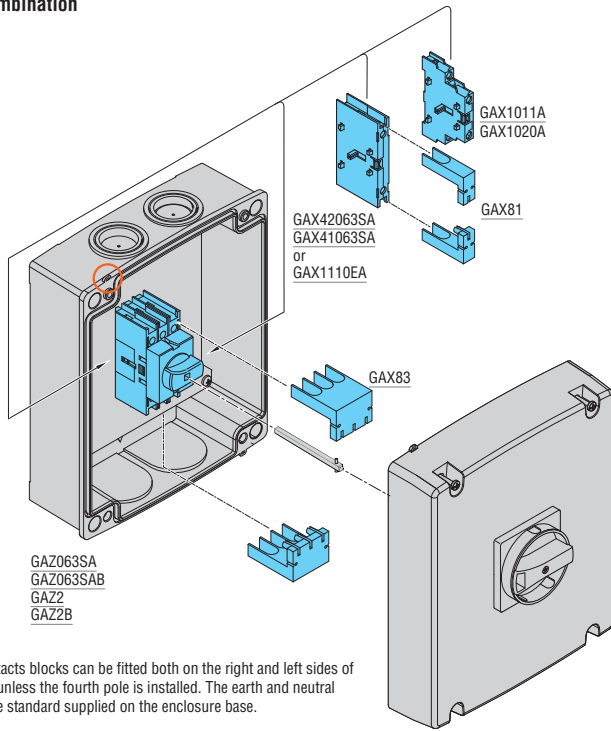

Two auxiliary contacts blocks can be fitted both on the right and left sides of the disconnector unless the fourth pole is installed. The earth and neutral plate terminals are standard supplied on the enclosure base.

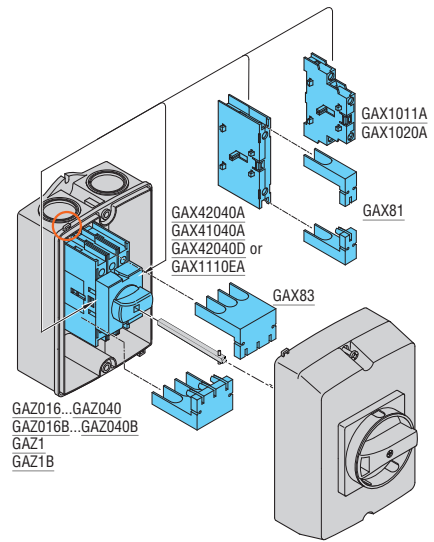

One auxiliary contact block can be fitted on the right and left sides of the disconnector unless the fourth pole is installed. The earth and neutral plate terminals are standard supplied on the enclosure base.

Sealing eyelet

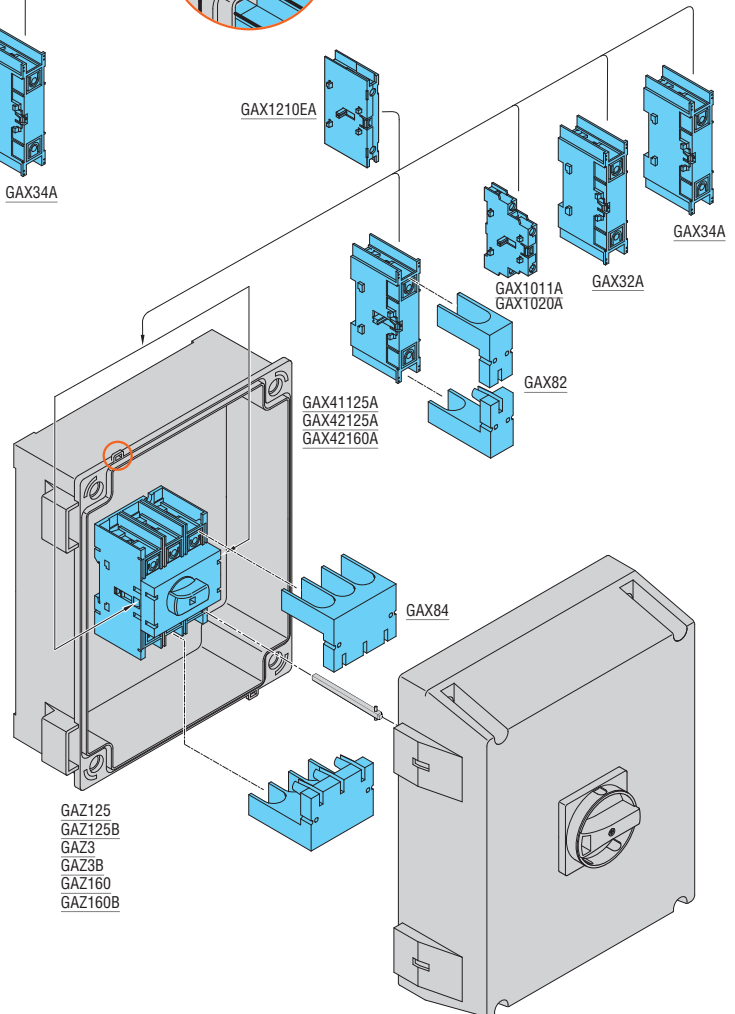
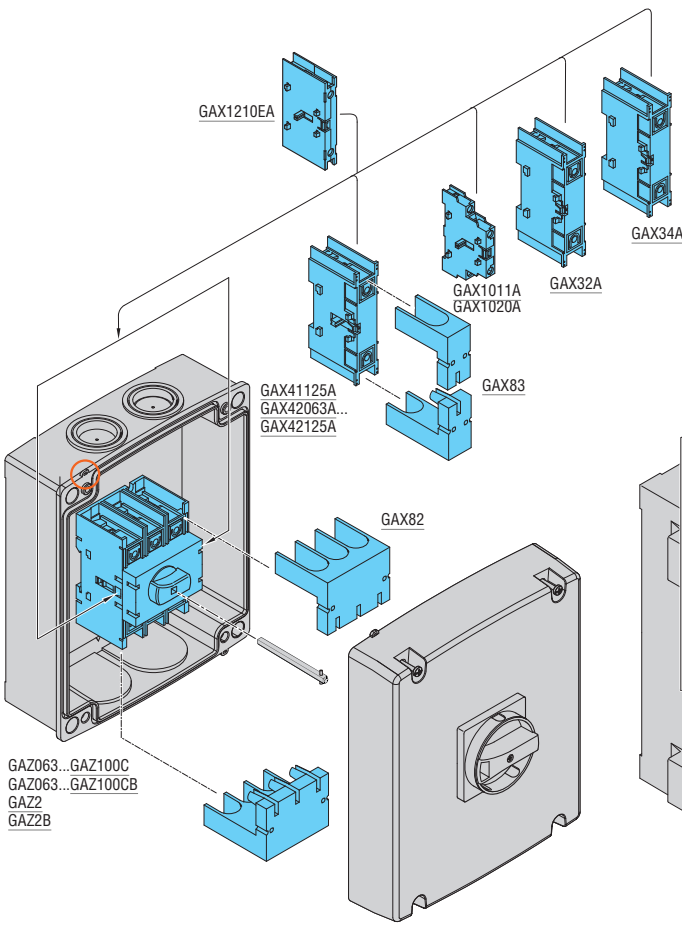
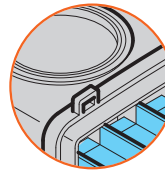

Two auxiliary contact blocks can be fitted both on the right and left sides of the disconnector unless the fourth pole is installed. Earth and neutral plate terminals are standard supplied on the box base. If any earth/ground and/or neutral terminals are required, type GAX3... purchase separately.

12 Switch disconnectors

GA series 16A to 160A.

Switch disconnectors in metal enclosure

IEC/EN IP65 in metal enclosure



GAZM016...GAZM100...



GAZM125...GAZM160...

Order code	IEC conventional thermal current I _{th}		IEC rated operational current I _e		Qty per pkg	Wt [kg]
	AC21A (≤690V)	AC23B (≤400V)	AC23B (≤400V)	AC23B (≤500V)		

THREE-POLE.
With red/yellow handle.

GAZM016	16	16	16	1	2.150
GAZM025	25	25	25	1	2.150
GAZM032	32	32	25	1	2.150
GAZM040	40	40	25	1	2.150
GAZM063SA	63	45	25	1	2.150
GAZM063	63	63	63	1	2.380
GAZM080	80	80	63	1	2.380
GAZM100	100	100	80	1	2.380
GAZM125	125	125	100	1	3.550
GAZM160	160	125	100	1	3.550

THREE-POLE.
With black handle.

GAZM016B	16	16	16	1	2.150
GAZM025B	25	25	25	1	2.150
GAZM032B	32	32	25	1	2.150
GAZM040B	40	40	25	1	2.150
GAZM063SAB	63	45	25	1	2.150
GAZM063B	63	63	63	1	2.380
GAZM080B	80	80	63	1	2.380
GAZM100B	100	100	80	1	2.380
GAZM125B	125	125	100	1	3.550
GAZM160B	160	125	100	1	3.550

FOUR-POLE.
With red/yellow handle.

GAZM016T4	16	16	16	1	2.195
GAZM032T4	32	32	25	1	2.195
GAZM040T4	40	40	25	1	2.195
GAZM063SAT4	63	45	25	1	2.195
GAZM063T4	63	63	63	1	2.506
GAZM100T4	100	100	80	1	2.506
GAZM125T4	125	125	100	1	3.676
GAZM160T4	160	125	100	1	3.676

FOUR-POLE.
With black handle.

GAZM016T4B	16	16	16	1	2.195
GAZM032T4B	32	32	25	1	2.195
GAZM040T4B	40	40	25	1	2.195
GAZM063SAT4B	63	45	25	1	2.195
GAZM063T4B	63	63	63	1	2.506
GAZM100T4B	100	100	80	1	2.506
GAZM125T4B	125	125	100	1	3.676
GAZM160T4B	160	125	100	1	3.676

Components

Enclosure	Switch disconnector	Handle
GAZM1	GA016A	GAX61
GAZM1	GA025A	GAX61
GAZM1	GA032A	GAX61
GAZM1	GA040A	GAX61
GAZM1	GA063SA	GAX61
GAZM1	GA063A	GAX61
GAZM1	GA080A	GAX61
GAZM1	GA100A	GAX61
GAZM2	GA125A	GAX61
GAZM2	GA160A	GAX61

GAZM1	GA016A	GAX61B
GAZM1	GA025A	GAX61B
GAZM1	GA032A	GAX61B
GAZM1	GA040A	GAX61B
GAZM1	GA063SA	GAX61B
GAZM1	GA063A	GAX61B
GAZM1	GA080A	GAX61B
GAZM1	GA100A	GAX61B
GAZM2	GA125A	GAX61B
GAZM2	GA160A	GAX61B

Enclosure	Switch disconnector	4th pole	Handle
GAZM1	GA016A	GAX42040A	GAX61
GAZM1	GA032A	GAX42040A	GAX61
GAZM1	GA040A	GAX42040A	GAX61
GAZM1	GA063SA	GAX42063SA	GAX61
GAZM1	GA063A	GAX42063A	GAX61
GAZM1	GA100A	GAX42100A	GAX61
GAZM2	GA125A	GAX42125A	GAX61
GAZM2	GA160A	GAX42160A	GAX61

GAZM1	GA016A	GAX42040A	GAX61B
GAZM1	GA032A	GAX42040A	GAX61B
GAZM1	GA040A	GAX42040A	GAX61B
GAZM1	GA063SA	GAX42063SA	GAX61B
GAZM1	GA063A	GAX42063A	GAX61B
GAZM1	GA100A	GAX42100A	GAX61B
GAZM2	GA125A	GAX42125A	GAX61B
GAZM2	GA160A	GAX42160A	GAX61B

① Extension shaft GAX7... has to be added; for more details contact our Technical support; see contact details on inside front cover.

General characteristics

- Enclosure material: painted sheet steel
- Padlockable handle
- Front door closing with screws
- Degree of protection: IP65
- Cable entry: smooth surfaces; can be drilled by customer.

Certifications and compliance

Certifications: EAC (pending).
Compliant with standards: IEC/EN/BS 60947-3, IEC/EN/BS 60947-1.

12 Switch disconnectors

GA series 16A to 160A.

Changeover switches in metal enclosure and switch disconnectors in stainless steel AISI 304 enclosure

IEC/EN IP65 in metal enclosure



GAZM080ET8...GAZM160ET8...

Order code	IEC conventional thermal current Ith AC21A (≤690V)		IEC rated operational current Ie AC23B (≤400V) AC23B (≤500V)		Qty per pkg	Wt [kg]
	[A]	[A]	[A]	[A]		
3-pole line changeover switches I-O-II. Black handle						
GAZM025ET6	25	25	25	25	1	1.983
GAZM040ET6	40	40	25	25	1	1.983
GAZM063SAET6	63	45	25	25	1	1.983
GAZM080ET6	80	80	63	63	1	3.156
GAZM125ET6	125	125	100	100	1	3.156
GAZM160ET6	160	125	100	100	1	3.156
4-pole line changeover switches I-O-II. Black handle.						
GAZM025ET8	25	25	25	25	1	2.100
GAZM040ET8	40	40	25	25	1	2.100
GAZM063SAET8	63	45	25	25	1	2.100
GAZM080ET8	80	80	63	63	1	5.953
GAZM125ET8	125	125	100	100	1	5.953
GAZM160ET8	160	125	100	100	1	5.953

IEC/EN IP65 in stainless steel AISI 304 enclosure



GAZS016...GAZS100...

Order code	IEC conventional thermal current Ith AC21A (≤690V)		IEC rated operational current Ie AC23B (≤400V) AC23B (≤500V)		Qty per pkg	Wt [kg]
	[A]	[A]	[A]	[A]		
THREE-POLE. With red/yellow handle.						
GAZS016	16	16	16	16	1	2.150
GAZS025	25	25	25	25	1	2.150
GAZS032	32	32	25	25	1	2.150
GAZS040	40	40	25	25	1	2.150
GAZS063SA	63	45	25	25	1	2.150
GAZS063	63	63	63	63	1	2.380
GAZS100	100	100	80	80	1	2.380
THREE-POLE. With black handle.						
GAZS016B	16	16	16	16	1	2.150
GAZS025B	25	25	25	25	1	2.150
GAZS032B	32	32	25	25	1	2.150
GAZS040B	40	40	25	25	1	2.150
GAZS063SAB	63	45	25	25	1	2.150
GAZS063B	63	63	63	63	1	2.380
GAZS100B	100	100	80	80	1	2.380

① Extension shaft GAX7... has to be added; for more details contact our Technical support; see contact details on inside front cover.

Components

Enclosure	Switches disconnectors	Mechanical interlock	Handle
GAZM1	2x GA025A	GAX5000	GAX67B
GAZM1	2x GA040A	GAX5000	GAX67B
GAZM1	2x GA063SA	GAX5000	GAX67B
GAZM2	2x GA080A	GAX5001	GAX67B
GAZM2	2x GA125A	GAX5001	GAX67B
GAZM2	2x GA160A	GAX5001	GAX67B
GAZM1	2x GA025A + 2x GAX42040A	GAX5000	GAX67B
GAZM1	2x GA040A + 2x GAX42040A	GAX5000	GAX67B
GAZM1	2x GA063SA + 2x GAX42063SA	GAX5000	GAX67B
GAZM3	2x GA080A + 2x GAX42080A	GAX5001	GAX67B
GAZM3	2x GA125A + 2x GAX42125A	GAX5001	GAX67B
GAZM3	2x GA160A + 2x GAX42160A	GAX5001	GAX67B

General characteristics

- Enclosure material: painted sheet steel
- Padlockable handle
- Front door closing with screws and hinges on the right side of the enclosure (GAZM080ET8...GAZM160ET8...)
- Degree of protection: IP65
- Cable entry: smooth surfaces; can be drilled by customer.

Certifications and compliance

Certifications: EAC (pending).
Compliant with standards: IEC/EN/BS 60947-3, IEC/EN/BS 60947-1.

Components

Enclosure	Switch disconnector	Handle
GAZS1	GA016A	GAX61
GAZS1	GA025A	GAX61
GAZS1	GA032A	GAX61
GAZS1	GA040A	GAX61
GAZS1	GA063SA	GAX61
GAZS1	GA063A	GAX61
GAZS1	GA100A	GAX61
GAZS1	GA016A	GAX61B
GAZS1	GA025A	GAX61B
GAZS1	GA032A	GAX61B
GAZS1	GA040A	GAX61B
GAZS1	GA063SA	GAX61B
GAZS1	GA063A	GAX61B
GAZS1	GA100A	GAX61B

General characteristics

- Enclosure material: AISI 304 stainless steel
- Padlockable handle
- Front door closing with screws
- Degree of protection: IP65
- Cable entry: smooth surfaces; can be drilled by customer
- For four-pole versions add the corresponding GAX42...A fourth pole to the switch disconnector.

Certifications and compliance

Certifications: EAC (pending).
Compliant with standards: IEC/EN/BS 60947-3, IEC/EN/BS 60947-1.

Enclosures



GAZM1



GAZM2



GAZM3



GAZS1

new

Order code	Enclosure dimensions	Qty per pkg	Wt
	[mm (in)]	n°	[kg]
Painted sheet steel enclosures.			
GAZM1	150x200x120 (5.90x7.87x4.72")	1	1.680
GAZM2	200x300x120 (7.87x11.81x4.72")	1	3.000
GAZM3	300x400x120 (11.8x15.75x4.72")	1	4.900
AISI 304 stainless steel enclosures.			
GAZS1	150x200x120 (5.90x7.87x4.72")	1	1.900

General characteristics

- Painted sheet steel enclosures for GAZM...
- AISI 304 stainless steel enclosures for GAZS1
- Front door closing with screws for GAZM1, GAZM2 and GAZS1
- Front door closing with screws and hinges on the right side of the enclosures for GAZM3
- Drilled cover for handle assembly
- Factory mounted 35mm DIN rail on the base
- Ground terminal included
- Degree of protection: IP65
- Cable entry: smooth surfaces; can be drilled by customer
- For compatible components see pages 12-23 and 24.

Compliance

Compliant with standards: IEC/EN/BS 60947-1.

SWITCH DISCONNECTORS



COMPACT SIZE
The three-pole switch disconnectors are made up of a body with compact dimensions: 162mm/6.38" wide up to 315A, 203mm/7.99" from 320A to 500A and 231mm/9.09" for 630A.

UL98 VERSION
Switch disconnectors are listed for USA and Canada, certified according to UL98/CSA C22.2 n° 4.

FOUR-POLE VERSION AVAILABLE
Switch disconnectors are supplied with three-pole configuration. To realise the four-pole version, a fourth-pole add-on can be purchased.

EASY INSTALLATION ON DIN RAIL
The switch disconnectors can be mounted on a DIN rail (for sizes from 160A to 315A) or on a plate by screw fixing.

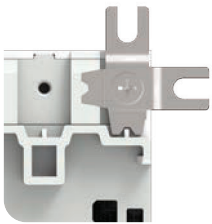

FLEXIBLE INSTALLATION ORIENTATION
Switch disconnectors can be installed in all directions. The clips for screw fixing can be adjusted both in rotation and position (flexible fixing).

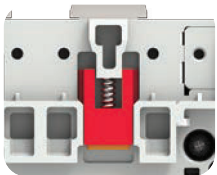

ANTI-SLIDE INSERT FOR DIN RAIL
For sizes from 160A to 315A there are two rubber pad inserts prevent the sliding of switch disconnectors on the DIN rail.

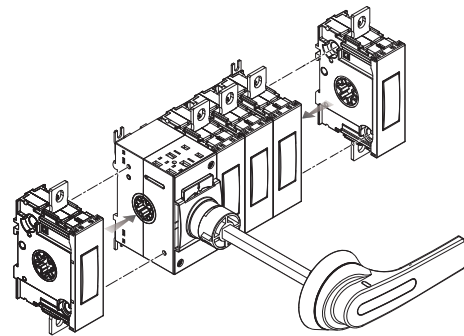

COMPONENT FLEXIBILITY
It is possible to mount the fourth pole, neutral and earth/ground terminals on both sides of the switch disconnectors using 2 screws.

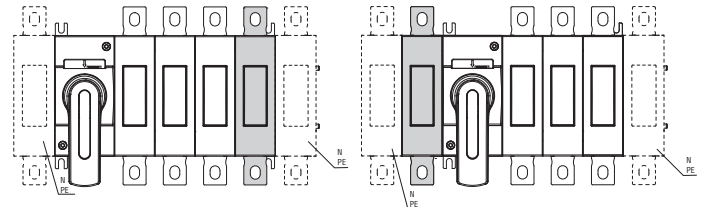

CHANGEOVER SWITCHES



COMPACT SIZE
Changeover switches are made up of a body with compact dimensions:
- 185mm/7.28" wide for three-pole versions up to 315A, 237mm/9.33" from 320A to 500A and 263mm/10.35" for 630A;
- 220mm/8.66" wide for the four-pole versions up to 315A, 281mm/11.06" from 320A to 500A and 317mm/12.48" for 630A.

EASY INSTALLATION
The changeover switches can be mounted on a plate by screws.

UL1008 VERSION
The changeover switches are listed for USA and Canada, certified according to UL1008/CSA C22.2 n° 178.

THREE AND FOUR-POLE VERSION
Changeover switches are already supplied assembled in three-pole and four-pole configuration.

12 Switch disconnectors

Overview.
GL series

● WIDE RANGE OF ACCESSORIES

A wide choice of auxiliary contacts, terminal covers, phase barriers, terminal clamps, bridging bars, shafts and handles are available to satisfy every installation need.



● HIGH IEC ELECTRICAL CAPABILITY

The rated currents in AC23A up to 630A-415V and 500A-690V are the highest of the category.

● ADD-ON AUXILIARY CONTACTS

The same add-on block is suitable for all the switch disconnectors and changeover switches. Contacts are mounted on main switching actuator (max 8 contacts for switch disconnectors; max 4 contacts for changeover switches).

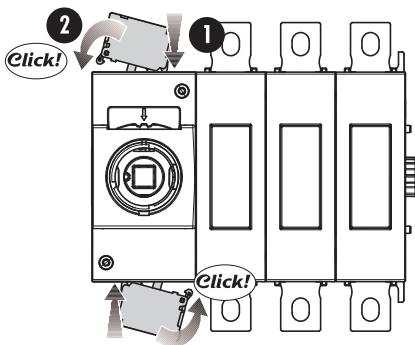
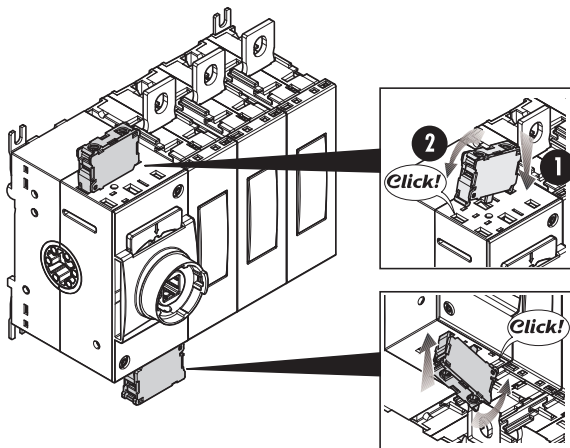

● VISIBLE CONTACTS: MAXIMUM SECURITY!

Thanks to the window on the individual power poles the open or closed switch status is clearly visible at a distance.



● UL508A DEFEATABLE HANDLE

In compliance with UL508A standards, which require internal panel inspection by authorized personnel with power applied, pistol handles are available with defeatable feature of the door coupling when the switch disconnector or the changeover switch is closed, i.e. in ON position.

● IP66, IP69K AND NEMA 4X HANDLES

A wide range of screw fixing pistol grip handles are available with the maximum degree of protection on the market.



● PADLOCKABLE HANDLES

All direct and door coupling handles are equipped with integrated padlock mechanism.

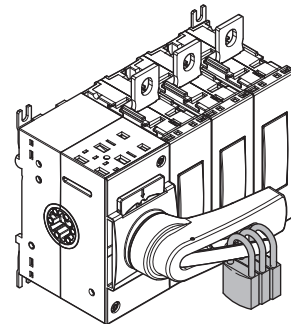

● HANDLES

Switch disconnectors and changeover switches are standard supplied without any handles. By purchasing the direct operating handle separately it is possible to create a direct operating version. The handles can be mounted and removed very easily thanks to the snap-on assembly.

By purchasing a shaft extension and a door coupling handle separately it is possible to create the door coupling version.

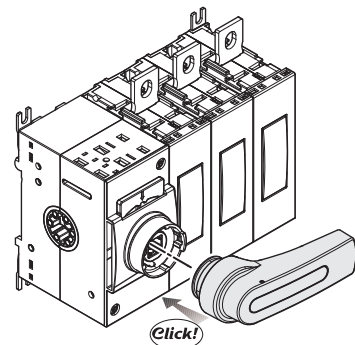

● SNAP-ON SHAFT MOUNTING

Shafts can be mounted and removed very easily by snapping on the front of the switch. This feature allows fast installation and easy accessibility to the panel in case of maintenance.

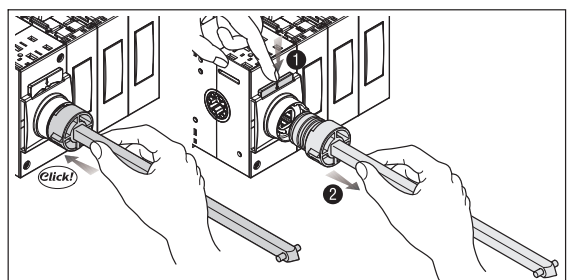

12 Switch disconnectors

GL series 160A to 630A



INDEX

Summary table of combinations



IEC/EN/BS

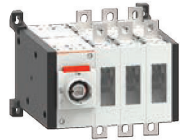
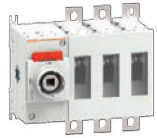

Type	IEC conventional free air thermal current I _{th}			IEC reactive power for control of capacitors 400V	Fourth pole	Neutral terminal	Earth/ground terminal	Direct operating handle	
	AC21A (≤690V)	AC23A (≤400V)	AC23A (≤500V)					Black	Red/Yellow
Order code	[A]	[A]	[A]	[kvar]	Order code	Order code	Order code	Order code	Order code
IEC/EN three-pole switch disconnectors.									
GL0160C1	160	160	160	80	GLX420315	GLX300	GLX301	GLX61DB	GLX61D
GL0200C1	200	200	200	100					
GL0250C1	250	250	250	115					
GL0315C1	315	315	250	145					
GL0320C1	320	320	320	145	GLX420320	GLX302	GLX303	GLX62DB	GLX62D
GL0400C1	400	400	400	180					
GL0500C1	500	500	500	200					
GL0630C1	630	630	500	250					
IEC/EN three-pole changeover switches.									
GLC0160C1	160	160	160	–	–	–	–	GLX61DB	–
GLC0200C1	200	200	200						
GLC0250C1	250	250	250						
GLC0315C1	315	315	250						
GLC0320C1	320	320	320	GLX62DB					
GLC0400C1	400	400	400						
GLC0500C1	500	500	500						
GLC0630C1	630	630	500						
IEC/EN four-pole changeover switches.									
GLC0160T4C1	160	160	160	–	–	–	–	GLX61DB	–
GLC0200T4C1	200	200	200						
GLC0250T4C1	250	250	250						
GLC0315T4C1	315	315	250						
GLC0320T4C1	320	320	320	GLX62DB					
GLC0400T4C1	400	400	400						
GLC0500T4C1	500	500	500						
GLC0630T4C1	630	630	500						

ULus

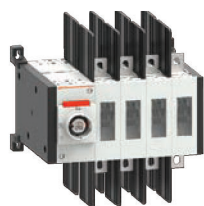
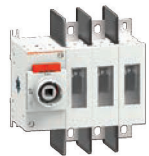

Type	General purpose current	Max 3-phase horsepower rating	Fourth pole	Neutral terminal	Earth/ground terminal	Direct operating handle		
						Black	Red/Yellow	
Order code	[A]	[HP/Voltage]	Order code	Order code	Order code	Order code	Order code	
UL98 three-pole switch disconnectors.								
GL0100C1UL	100	30/240 - 75/480 - 100/600	GLX420100UL	GLX300	GLX301	GLX61DB	GLX61D	
GL0200C1UL	200	75/240 - 150/480 - 200/600						
GL0400C1UL	400	125/240 - 250/480 - 350/600	GLX420400UL	GLX302	GLX303	GLX62DB	GLX62D	
UL1008 three-pole changeover switches.								
GLC0100C1UL	100	30/240 - 75/480 - 100/600	–	–	–	GLX61DB	–	
GLC0200C1UL	200	75/240 - 150/480 - 200/600						
GLC0400C1UL	400	125/240 - 250/480 - 350/600				GLX62DB		
UL1008 four-pole changeover switches.								
GLC0100T4C1UL	100	30/240 - 75/480 - 100/600	–	–	–		GLX61DB	–
GLC0200T4C1UL	200	75/240 - 150/480 - 200/600						
GLC0400T4C1UL	400	125/240 - 250/480 - 350/600				GLX62DB		

- 1-piece set. 1 terminal connection for single cable:
 - Maximum conductor cross section: 120mm²/250kcmil;
 - Minimum conductor cross section: 16mm²/6AWG.
- 3-piece set. 3 terminals connection for single cable:
 - Maximum conductor cross section: 120mm²/250kcmil;
 - Minimum conductor cross section: 16mm²/6AWG.
- 1-piece set. 1 terminal connection for single cable:
 - Maximum conductor cross section: 304mm²/600kcmil;
 - Minimum conductor cross section: 33.6mm²/2AWG.

12 Switch disconnectors

GL series 160A to 630A



Door coupling handle		Shaft extensions for door coupling handles			Shaft alignment ring	Auxiliary contacts	Terminal covers	Phase barriers	Terminal clamps	Bridging bars	Captive nuts	
Black	Red/Yellow	Order code	Panel depth									Shaft section
Order code	Order code		Order code	min [mm/in]	max [mm/in]	□ [mm/in]	Order code	Order code	Order code	Order code	Order code	Order code
GLX61B	GLX61	GLX7150S10 GLX7200S10 GLX7300S10 GLX7400S10 GLX7500S10	124/ 4.88"	194/7.64" 244/9.61" 344/13.54" 444/17.48" 544/21.42"	10/0.4"	GLX00	GLX1001 (1NC) GLX1010EA (1EB)	GLX800 (3 pcs) GLX801 (4 pcs)	GLX900 (6 pcs) GLX901 (8 pcs)	GLX500 Ⓢ GLX501 Ⓢ	–	GLX550 (8 pcs)
GLX62B	GLX62	GLX7150S10 GLX7200S10 GLX7300S10 GLX7400S10 GLX7500S10	157/ 6.18"	227/8.94" 277/10.90" 377/14.84" 477/18.78" 577/22.72"				GLX802 (3 pcs) GLX803 (4 pcs)	GLX902 (6 pcs) GLX903 (8 pcs) Built-in	GLX502 Ⓢ GLX503 Ⓢ GLX504 Ⓢ GLX505 Ⓢ		GLX551 (8 pcs)
GLX61CB	–	GLX7150S10 GLX7200S10 GLX7300S10 GLX7400S10 GLX7500S10	220/ 8.66"	290/11.42" 340/13.38" 440/17.32" 540/21.26" 640/25.20"	10/0.4"	GLX00	GLX1001 (1NC) GLX1010EA (1EB)	GLX800 (3 pcs) GLX801 (4 pcs)	GLX900 (6 pcs) GLX901 (8 pcs)	GLX500 Ⓢ GLX501 Ⓢ	GLX201 (3 pcs) GLX202 (4 pcs)	GLX550 (8 pcs)
GLX62CB		GLX7150S10 GLX7200S10 GLX7300S10 GLX7400S10 GLX7500S10	267/ 10.51"	337/13.27" 387/15.24" 487/19.17" 587/23.11" 687/27.05"				GLX802 (3 pcs) GLX803 (4 pcs)	GLX902 (6 pcs) GLX903 (8 pcs) Built-in	GLX502 Ⓢ GLX503 Ⓢ GLX504 Ⓢ GLX505 Ⓢ	GLX206 (3 pcs) GLX207 (4 pcs)	GLX551 (8 pcs)
GLX61CB	–	GLX7150S10 GLX7200S10 GLX7300S10 GLX7400S10 GLX7500S10	220/ 8.66"	290/11.42" 340/13.38" 440/17.32" 540/21.26" 640/25.20"	10/0.4"	GLX00	GLX1001 (1NC) GLX1010EA (1EB)	GLX800 (3 pcs) GLX801 (4 pcs)	GLX900 (6 pcs) GLX901 (8 pcs)	GLX500 Ⓢ GLX501 Ⓢ	GLX201 (3 pcs) GLX202 (4 pcs)	GLX550 (8 pcs)
GLX62CB		GLX7150S10 GLX7200S10 GLX7300S10 GLX7400S10 GLX7500S10	267/ 10.51"	337/13.27" 387/15.24" 487/19.17" 587/23.11" 687/27.05"				GLX802 (3 pcs) GLX803 (4 pcs)	GLX902 (6 pcs) GLX903 (8 pcs) Built-in	GLX502 Ⓢ GLX503 Ⓢ GLX504 Ⓢ GLX505 Ⓢ	GLX206 (3 pcs) GLX207 (4 pcs)	GLX551 (8 pcs)
GLX61B	GLX61	GLX7150S10 GLX7200S10 GLX7300S10 GLX7400S10 GLX7500S10	124/ 4.88"	194/7.64" 244/9.61" 344/13.54" 444/17.48" 544/21.42"	10/0.4"	GLX00	GLX1001 (1NC) GLX1010EA (1EB)	GLX800 (3 pcs) GLX801 (4 pcs)	Built-in	GLX500 Ⓢ GLX501 Ⓢ	–	GLX550 (8 pcs)
GLX62B	GLX62	GLX7150S10 GLX7200S10 GLX7300S10 GLX7400S10 GLX7500S10	157/ 6.18"	227/8.94" 277/10.90" 377/14.84" 477/18.78" 577/22.72"				GLX802 (3 pcs) GLX803 (4 pcs)	Built-in	GLX502 Ⓢ GLX503 Ⓢ GLX504 Ⓢ GLX505 Ⓢ		GLX551 (8 pcs)
GLX61CB	–	GLX7150S10 GLX7200S10 GLX7300S10 GLX7400S10 GLX7500S10	220/ 8.66"	290/11.42" 340/13.38" 440/17.32" 540/21.26" 640/25.20"	10/0.4"	GLX00	GLX1001 (1NC) GLX1010EA (1EB)	GLX800 (3 pcs) GLX801 (4 pcs)	Built-in	GLX500 Ⓢ GLX501 Ⓢ	GLX201 (3 pcs) GLX202 (4 pcs)	GLX550 (8 pcs)
GLX62CB		GLX7150S10 GLX7200S10 GLX7300S10 GLX7400S10 GLX7500S10	267/ 10.51"	337/13.27" 387/15.24" 487/19.17" 587/23.11" 687/27.05"				GLX802 (3 pcs) GLX803 (4 pcs)	Built-in	GLX502 Ⓢ GLX503 Ⓢ GLX504 Ⓢ GLX505 Ⓢ	GLX206 (3 pcs) GLX207 (4 pcs)	GLX551 (8 pcs)
GLX61CB	–	GLX7150S10 GLX7200S10 GLX7300S10 GLX7400S10 GLX7500S10	220/ 8.66"	290/11.42" 340/13.38" 440/17.32" 540/21.26" 640/25.20"	10/0.4"	GLX00	GLX1001 (1NC) GLX1010EA (1EB)	GLX800 (3 pcs) GLX801 (4 pcs)	Built-in	GLX500 Ⓢ GLX501 Ⓢ	GLX201 (3 pcs) GLX202 (4 pcs)	GLX550 (8 pcs)
GLX62CB		GLX7150S10 GLX7200S10 GLX7300S10 GLX7400S10 GLX7500S10	267/ 10.51"	337/13.27" 387/15.24" 487/19.17" 587/23.11" 687/27.05"				GLX802 (3 pcs) GLX803 (4 pcs)	Built-in	GLX502 Ⓢ GLX503 Ⓢ GLX504 Ⓢ GLX505 Ⓢ	GLX206 (3 pcs) GLX207 (4 pcs)	GLX551 (8 pcs)

● 3-piece set. 3 terminals connection for single cable:
– Maximum conductor cross section: 304mm²/600kcmil;
– Minimum conductor cross section: 33.6mm²/2AWG.

● 1-piece set. 1 terminal connection for double cables:
– Maximum conductor cross section: 2x152mm²/2x300kcmil;
– Minimum conductor cross section: 2x21.2mm²/2x4AWG.

● 3-piece set. 3 terminals connection for double cables:
– Maximum conductor cross section: 2x152mm²/2x300kcmil;
– Minimum conductor cross section: 2x21.2mm²/2x4AWG.

11 Switch disconnectors

GL series 160A to 630A

IEC/EN three-pole switch disconnectors



GL0160C1...GL0315C1



GL0320C1...GL0500C1

Order code	IEC conventional free air thermal current Ith AC21A (≤690V)	IEC rated operational current Ie		Qty per pkg	Wt [kg]
		AC23A (≤400V)	AC23A (≤690V)		
	[A]	[A]	[A]	n°	[kg]

Supplied without handle.
Complete the switch disconnector by selecting shaft extension and handle for door coupling version or the handle for direct operating version (see page 12-33).

GL0160C1	160	160	160	1	1.740
GL0200C1	200	200	200	1	1.740
GL0250C1	250	250	250	1	1.740
GL0315C1	315	315	250	1	1.740
GL0320C1	320	320	320	1	3.460
GL0400C1	400	400	400	1	3.460
GL0500C1	500	500	500	1	3.460
GL0630C1	630	630	500	1	3.780

new

UL98 three-pole switch disconnectors



GL...C1UL

Order code	General purpose current [A]	Max. 3-phase horsepower rating [HP/V]	Qty per pkg	Wt [kg]

Supplied without handle.
Complete the switch disconnector by selecting shaft extension and handle for door coupling version or the handle for direct operating version (see page 12-33).

GL0100C1UL	100	30/240 75/480 100/600	1	1.900
GL0200C1UL	200	75/240 150/480 200/600	1	1.900
GL0400C1UL	400	125/240 250/480 350/600	1	3.780

new

new

IEC/EN fourth pole add-on



GLX420315 GLX420500 GLX420630

Order code	IEC conventional free air thermal current Ith AC21A (≤690V)	IEC rated operational current Ie		Qty per pkg	Wt [kg]
		AC23A (≤400V)	AC23A (≤690V)		
	[A]	[A]	[A]	n°	[kg]

Simultaneous closing operation as switch disconnector poles. For GL0160C1...GL0315C1 versions.

GLX420315	315	315	250	1	0.400
For GL0320C1...GL0630C1 versions.					
GLX420320	320	320	320	1	0.900
GLX420400	400	400	400	1	0.900
GLX420500	500	500	500	1	0.900
GLX420630	630	630	500	1	0.900

new

UL98 fourth pole add-on



GLX420200UL GLX420400UL

Order code	General purpose current [A]	Max. 3-phase horsepower rating [HP/V]	Qty per pkg	Wt [kg]

Simultaneous closing operation as switch disconnector poles. For GL0100C1UL version.

GLX420100UL	100	30/240 75/480 100/600	1	0.410
For GL0200C1UL version.				
GLX420200UL	200	75/240 150/480 200/600	1	0.410
For GL0400C1UL version switch disconnector.				
GLX420400UL	400	125/240 250/480 350/600	1	0.900

new

new

General characteristics

- 160 to 630A AC23 versions
- 100A, 200A and 400A general purpose according to UL98
- Compact dimensions and add-on fourth-pole
- Screw or 35mm DIN rail fixing to 315A, only on a plate from 320A to 630A
- Possibility to adjust the position of the clips for screw fixing on plate
- Visible contacts
- Maximum number of power poles: 4.

Operational characteristics

- Rated insulation voltage Ui: 1,000V
- Rated impulse withstand Uimp: 12kV
- Mechanical life:
 - 20,000 cycles from 160A to 315A
 - 10,000 cycles from 320A to 630A.

Certifications and compliance

Certifications obtained: cULus according to UL98 / CSA C22.2 n°4 for GL...UL and GLX42...UL types.
Compliant with standards: IEC/EN/BS 60947-3, IEC/EN/BS 60947-1.

Strokes of GL poles (main poles and add-on pole)

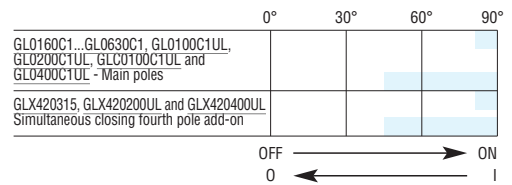

12 Switch disconnectors

GL series 160A to 630A

IEC/EN three-pole changeover switches

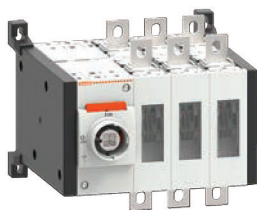

GLC0160C1...GLC0315C1

new

Order code	IEC conventional free air thermal current Ith AC21A (≤690V)	IEC rated operational current Ie		Qty per pkg	Wt [kg]
		AC33B (≤400V)	AC33B (≤690V)		
	[A]	[A]	[A]	n°	[kg]
Supplied without handle ❶.					
GLC0160C1	160	160	160	1	3.550
GLC0200C1	200	200	200	1	3.550
GLC0250C1	250	250	250	1	3.550
GLC0315C1	315	315	250	1	3.550
GLC0320C1	320	320	320	1	7.060
GLC0400C1	400	400	400	1	7.060
GLC0500C1	500	500	500	1	7.060
GLC0630C1	630	630	500	1	7.720

General characteristics

- 160 to 630A AC33 versions
- 100A, 200A and 400A general purpose according to UL1008
- Screw fixing on plate
- Visible contacts.

Operational characteristics

- Rated insulation voltage Ui: 1,000V
- Rated impulse withstand Uimp: 12kV
- Mechanical life:
 - 20,000 cycles from 160A to 315A
 - 10,000 cycles from 320A to 630A.

Certifications and compliance

Certifications obtained: cULus according to UL1008 (pending for GLC0400...UL types).
Compliant with standards: IEC/EN 60947-6-1, IEC/EN 60947-3.

Strokes of GLC poles

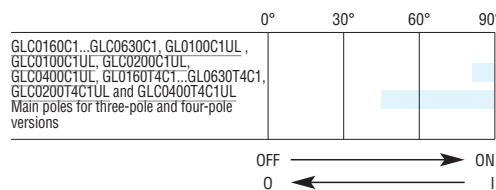

IEC/EN four-pole changeover switches



GLC0160T4C1...GLC0315T4C1

new

Order code	IEC conventional free air thermal current Ith AC21A (≤690V)	IEC rated operational current Ie		Qty per pkg	Wt [kg]
		AC33B (≤400V)	AC33B (≤690V)		
	[A]	[A]	[A]	n°	[kg]
Supplied without handle ❶.					
GLC0160T4C1	160	160	160	1	4.330
GLC0200T4C1	200	200	200	1	4.330
GLC0250T4C1	250	250	250	1	4.330
GLC0315T4C1	315	315	250	1	4.330
GLC0320T4C1	320	320	320	1	8.810
GLC0400T4C1	400	400	400	1	8.810
GLC0500T4C1	500	500	500	1	8.810
GLC0630T4C1	630	630	500	1	9.460

UL1008 three-pole changeover switches



GLC0200C1UL

new

new

Order code	General purpose current [A]	Max. 3-phase horsepower rating [HP/V]	Qty per pkg	Wt [kg]
Supplied without handle ❶.				
GLC0100C1UL	100	30/240 75/480 100/600	1	3.800
GLC0200C1UL	200	75/240 150/480 200/600	1	3.800
GLC0400C1UL	400	125/240 250/480 350/600	1	7.560

UL1008 four-pole changeover switches

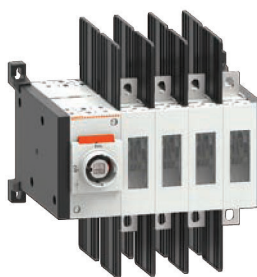

GLC0200T4C1UL

new

new

Order code	General purpose current [A]	Max. 3-phase horsepower rating [HP/V]	Qty per pkg	Wt [kg]
Supplied without handle ❶.				
GLC0100T4C1UL	100	30/240 75/480 100/600	1	4.590
GLC0200T4C1UL	200	75/240 150/480 200/600	1	4.590
GLC0400T4C1UL	400	125/240 250/480 350/600	1	7.680

❶ Complete the changeover switch by selecting shaft extension and handle for door coupling version or the handle for direct operating version (see page 12-33).

12 Switch disconnectors

GL series 160A to 630A.
Accessories

Add-on blocks



GLX1010EA



GLX1001



GLX300



GLX301

new

new



GLX8...

new



GLX9...

new



GLX5 00 - GLX5 01



GLX502 - GLX503



GLX504 - GLX505

new



GLX55...

new

Order code	Characteristics	Qty per pkg	Wt
		n°	[kg]
Auxiliary contacts.			
GLX1001	1NC with screw terminals	1	0.100
GLX1010EA	1EB with screw terminals	1	0.100
Neutral terminal.			
GLX300	For GL0100...GL0315	1	0.340
GLX302	For GL0320...GL0630	1	0.680
Earth/ground terminal.			
GLX301	For GL0100...GL0315	1	0.340
GLX303	For GL0320...GL0630	1	0.680
One-pole terminal covers.			
GLX800	3-piece set. 3 terminals protections. For GL0100...GL0315 and GLC0100...GLC0315	1	0.060
GLX801	4-piece set. 4 terminals protections. For GL0100...GL0315 and GLC0100...GLC0315	1	0.080
GLX802	3-piece set. 3 terminals protections. For GL0320...GL0630 and GLC0320...GLC0630	1	0.070
GLX803	4-piece set. 4 terminals protections. For GL0320...GL0630 and GLC0320...GLC0630	1	0.095
One-pole phase barrier (needed for voltages > 500V).			
GLX900	6-piece set. 3 terminals protections. For GL0160...GL0315 and GLC0100...GLC0315	1	0.070
GLX901	8-piece set. 4 terminals protections. For GL0160...GL0315 and GLC0100...GLC0315	1	0.090
GLX902	6-piece set. 3 terminals protections. For GL0320...GL0630 and GLC0320...GLC0630	1	0.011
GLX903	8-piece set. 4 terminals protections. For GL0320...GL0500 and GLC0320...GLC0500	1	0.011
Terminal clamp sets for rigid and flexible cables.			
GLX500	1-piece set. 1 terminal connection for single cable. For GL0100...GL0315 and GLC0100...GLC0315	1	0.050
GLX501	3-piece set. 3 terminals connection for single cable. For GL0100...GL0315 and GLC0100...GLC0315	1	0.140
GLX502	1-piece set. 1 terminal connection for single cable. For GL0320...GL0630 and GLC0320...GLC0630	1	0.100
GLX503	3-piece set. 3 terminals connection for single cable. For GL0320...GL0630 and GLC0320...GLC0630	1	0.280
GLX504	1-piece set. 1 terminal connection for double cables. For GL0320...GL0630 and GLC0320...GLC0630	1	0.110
GLX505	3-piece set. 3 terminals connection for double cables. For GL0320...GL0630 and GLC0320...GLC0630	1	0.310
Captive nuts.			
GLX550	8-piece set. For GL0100...GL0315 and GLC0100...GLC0315	1	0.010
GLX551	8-piece set. For GL0320...GL0630 and GLC0320...GLC0630	1	0.010

Operational characteristics of auxiliary contacts GLX10...

- Conventional free air thermal current I_{th}: 10A
- Rated insulation voltage: 690V
- Conductivity: 5V, 1mA
- UL/CSA and IEC/EN 60947-5-1 designation: A600 Q600
- Tightening torque: 0.8Nm/7.1lb.in
- Maximum 8 contacts (2 for slot) for GL0160...GL0630 switch disconnectors
- Maximum 4 contacts for position (1 for slot) for GLC0160...GLC0630 changeover switches
- snap-on assembly without the use of tools.

Operational characteristics of neutral and earth/ground terminals GLX3...

- Add-on only on GL0100...GL0630 switch disconnectors
- Tightening torque for GLX300 and GLX301: 15...22Nm/132.7...194.7lb.in
- Tightening torque for GLX302 and GLX303: 30...37Nm/265...327lb.in.

Operational characteristics for terminal covers and phase barriers GLX8..., GLX9...

- Snap-on mounting.

Operational characteristics for terminal clamps GLX500-GLX501

- Maximum conductor cross section: 120mm²/250kcmil
- Minimum conductor cross section: 16mm²/6AWG
- Tightening torque: 35Nm/309.7lb.in.

GLX502-GLX503

- Maximum conductor cross section: 304mm²/600kcmil
- Minimum conductor cross section: 33.6mm²/2AWG
- Tightening torque: 42.4Nm/375lb.in

GLX504-GLX505

- Maximum conductor cross section: 2x152mm²/2x300kcmil
- Minimum conductor cross section: 2x21.2mm²/2x4AWG
- Tightening torque: 22.6Nm/200lb.in

Certifications and compliance

Certifications obtained: cULus
Compliant with standards: IEC/EN/BS 60947-1, IEC/EN/BS 60947-3.

Strokes of GL poles (main poles with add-on pole)

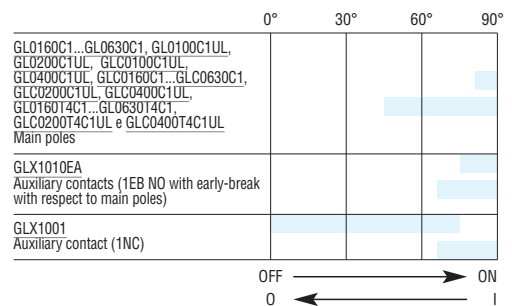

12 Switch disconnectors

GL series 160A to 630A.
Accessories

Parallel connections



GLX2...

Order code	Characteristics	Qty per pkg	Wt
		n°	[kg]
One-pole bridging bars for changeover parallel connection GLC0100...GLC0630.			
GLX201	3-piece set. Connection 3 poles. For GLC0100...GLC0315	1	0.180
GLX202	4-piece set. Connection 4 poles. For GLC0100...GLC0315	1	0.200
GLX206	3-piece set. Connection 3 poles. For GLC0320...GLC0630	1	0.190
GLX207	4-piece set. Connection 3 poles. For GLC0320...GLC0630	1	0.255

Handles and shafts



GLX61DB

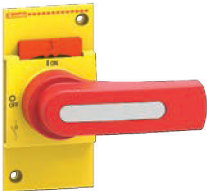

GLX61D



GLX61B



GLX61CB



GLX62B



GLX62CB



GLX00



GLX7...

new

new

Order code	Characteristics	Qty per pkg	Wt
		n°	[kg]
Direct operating handles.			
GLX61DB	For GL0100...GL0315 and GLC0100...GLC0315. Black	1	0.075
GLX61D	For GL0100...GL0315. Red/yellow	1	0.075
GLX62DB	For GL0320...GL0630 and GLC0320...GLC0630. Black	1	0.140
GLX62D	For GL0320...GL0630. Red/yellow	1	0.170

Order code	Characteristics	Qty per pkg	Wt
		n°	[kg]
Door coupling handles.			
GLX61	For GL0100...GL0315. Screw fixing. 125mm/4.92" lever length pistol handle - defeatable (req. UL508A). Red/yellow. □10mm/0.39"	1	0.220
GLX61B	For GL0100...GL0315. Screw fixing. 125mm/4.92" lever length pistol handle - defeatable (req. UL508A). Black. □10mm/0.39"	1	0.220
GLX61CB	For GLC0100...GLC0315. Screw fixing. 125mm/4.92" lever length pistol handle - defeatable (req. UL508A). Black. □10mm/0.39"	1	0.215
GLX62	For GL0320...GL0630. Screw fixing. 175mm/6.89" lever length pistol handle - defeatable (req. UL508A). Red/yellow. □10mm/0.39"	1	0.240
GLX62B	For GL0320...GL0630. Screw fixing. 175mm/6.89" lever length pistol handle - defeatable (req. UL508A). Black. □10mm/0.39"	1	0.240
GLX62CB	For GLC0320...GLC0630. Screw fixing. 175mm/6.89" lever length pistol handle - defeatable (req. UL508A). Black. □10mm/0.39"	1	0.240

Order code	Characteristics	Qty per pkg	Wt
		n°	[kg]
Accessories for door coupling handles.			
GLX00	Shaft alignment ring	1	0.040
Shaft extensions for door coupling handles GLX61, GLX61B, GLX61CB, GLX62, GLX62B, GLX62CB.			
GLX7150S10	150mm/5.90", □10mm/0.39"	1	0.150
GLX7200S10	200mm/7.87", □10mm/0.39"	1	0.190
GLX7300S10	300mm/11.81", □10mm/0.39"	1	0.270
GLX7400S10	400mm/15.75", □10mm/0.39"	1	0.350
GLX7500S10	500mm/19.68", □10mm/0.39"	1	0.430

Operational characteristics for direct operating handles

- Snap-on mounting on switch disconnectors and changeover switches
- 1 to 3 padlocks in the Ø4...6mm/0.16...0.24".

Operational characteristics for door coupling handles

- Handle fixing centres: 28x40mm/1.10x1.57"
- 1 to 3 padlocks in the Ø4...8mm/0.16...0.31"
- Tightening torque: 1.5Nm/13.3lb.in
- Degree of protection:
 - Per IEC/EN: IP66 and IP69K
 - Per UL: Type 1, 2, 3R, 12, 12K, 4, 4X external use.

Certifications and compliance

Certifications obtained: cULus.
Compliant with standards: IEC/EN 60947-1, IEC/EN 60947-3.

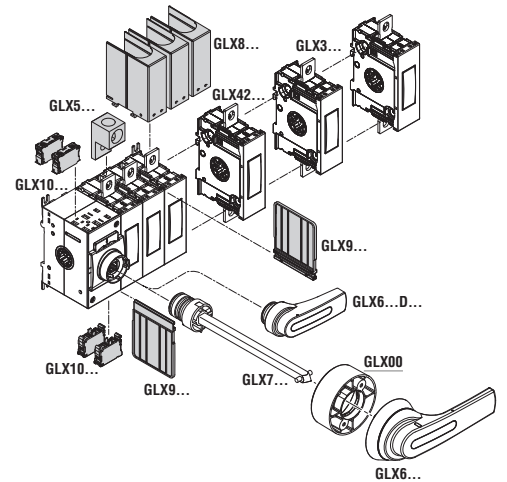

12 Switch disconnectors

GL series 160A to 315A.

Switch disconnectors in metal enclosure

IEC/EN IP65 in metal enclosure



GLZM0160...GLZM315...

Order code	IEC conventional thermal current I _{th} AC21A (≤690V)	IEC rated operational current I _e AC23A (≤400V)	Qty per pkg	Wt [kg]
	[A]	[A]	n°	[kg]

THREE-POLE.
With red/yellow handle.

GLZM0160	160	160	1	9.750
GLZM0200	200	200	1	9.750
GLZM0250	250	250	1	9.750
GLZM0315	315	315	1	9.750

THREE-POLE.
With black handle.

GLZM0160B	160	160	1	9.750
GLZM0200B	200	200	1	9.750
GLZM0250B	250	250	1	9.750
GLZM0315B	315	315	1	9.750

FOUR-POLE.
With red/yellow handle.

GLZM0160T4	160	160	1	9.950
GLZM0200T4	200	200	1	9.950
GLZM0250T4	250	250	1	9.950
GLZM0315T4	315	315	1	9.950

FOUR-POLE.
With black handle.

GLZM0160T4B	160	160	1	9.950
GLZM0200T4B	200	200	1	9.950
GLZM0250T4B	250	250	1	9.950
GLZM0315T4B	315	315	1	9.950

Components

Enclosure	Switch disconnector	Handle
GLZM1	GL0160C1	GLX61
GLZM1	GL0200C1	GLX61
GLZM1	GL0250C1	GLX61
GLZM1	GL0315C1	GLX61

GLZM1	GL0160C1	GLX61B
GLZM1	GL0200C1	GLX61B
GLZM1	GL0250C1	GLX61B
GLZM1	GL0315C1	GLX61B

Enclosure	Switch disconnector	4th pole	Handle
GLZM1	GL0160C1	GLX420315	GLX61
GLZM1	GL0200C1	GLX420315	GLX61
GLZM1	GL0250C1	GLX420315	GLX61
GLZM1	GL0315C1	GLX420315	GLX61

GLZM1	GL0160C1	GLX420315	GLX61B
GLZM1	GL0200C1	GLX420315	GLX61B
GLZM1	GL0250C1	GLX420315	GLX61B
GLZM1	GL0315C1	GLX420315	GLX61B

General characteristics

- Enclosure material: painted sheet steel
- Padlockable handle
- Front door closing with screws and hinges on the right side of the enclosure
- Degree of protection: IP65
- Cable entry: smooth surfaces; can be drilled by customer.

Certifications and compliance

Certifications: EAC (pending).
Compliant with standards: IEC/EN/BS 60947-3, IEC/EN/BS 60947-1.

12 Switch disconnectors

GL series 160A to 315A.

Changeover switches in metal enclosure

IEC/EN IP65 in metal enclosure



GLZM0160E...GLZM0315E...

Order code	IEC conventional thermal current I _{th}	IEC rated operational current I _e		Qty per pkg	Wt [kg]
	AC21A (≤690V)	AC23B (≤400V)	AC23B (≤500V)		
	[A]	[A]	[A]	n°	[kg]
3-pole line changeover switches I-O-II. Black handle					
GLZM0160ET6	160	160	160	1	11.780
GLZM0200ET6	200	200	200	1	11.780
GLZM0250ET6	250	250	250	1	11.780
GLZM0315ET6	315	315	250	1	11.780
4-pole line changeover switches I-O-II. Black handle.					
GLZM0160ET8	160	160	160	1	12.180
GLZM0200ET8	200	200	200	1	12.180
GLZM0250ET8	250	250	250	1	12.180
GLZM0315ET8	315	315	250	1	12.180

Components

Enclosure switch	Changeover	Handle
GLZM1	GLC0160C1	GLX61CB
GLZM1	GLC0200C1	GLX61CB
GLZM1	GLC0250C1	GLX61CB
GLZM1	GLC0315C1	GLX61CB
Enclosure	Changeover switch	Handle
GLZM1	GLC0160T4C1	GLX61CB
GLZM1	GLC0200T4C1	GLX61CB
GLZM1	GLC0250T4C1	GLX61CB
GLZM1	GLC0315T4C1	GLX61CB

General characteristics

- Enclosure material: painted sheet steel
- Padlockable handle
- Front door closing with screws and hinges on the right side of the enclosure
- Degree of protection: IP65
- Cable entry: smooth surfaces; can be drilled by customer.

Certifications and compliance

Certifications: EAC (pending).
Compliant with standards: IEC/EN/BS 60947-6-1, IEC/EN/BS 60947-1.

Enclosures



GLZM1

new

Order code	Enclosure dimensions	Qty per pkg	Wt
	[mm (in)]	n°	[kg]
Painted sheet steel enclosures.			
GLZM1	300x400x250 (11.8x15.75x9.84")	1	5.700

General characteristics

- Painted sheet steel enclosures
- Front door closing with screws and hinges on the right side of the enclosures
- Drilled cover for handle assembly
- Ground terminal included
- Degree of protection: IP65
- Cable entry: smooth surfaces; can be drilled by customer.

Compliance

Compliant with standards: IEC/EN/BS 60947-1.

12 Switch disconnectors

GE series 50A to 1600A.
Three-pole

Three-pole switch disconnectors



GE...

Order code	IEC conventional free air thermal current I _{th} AC21A (≤500V)	IEC rated operational current I _e		Qty per pkg	Wt [kg]
		AC23A (≤400V)	AC23A (≤500V)		
	[A]	[A]	[A]	n°	[kg]
Separately purchase the handle and shaft extension ❶.					
GE0160P ❶	160	160	125	1	0.850
GE0160	160	160	125	1	0.850
GE0200	200	160	125	1	0.900
GE0250	250❷	160	125	1	0.900
GE0251	250	250	200	1	1.700
GE0315	315	315	250	1	1.700
GE0400	400	400	315	1	1.900
GE0500	500	500	400	1	4.200
GE0630	630	630	500	1	4.200
GE0800	800	800	500	1	4.200
GE1000	1000	1000	800	1	7.000
GE1250	1250	1000	800	1	7.600
GE1600	1600	1000	900	1	20.800

Three-pole switch disconnectors with fuse holder



GE...F - GE...N - GE...B

With NFC fuse holder ❸❹.					
Separately purchase the handle and shaft extension ❶❷.					
Order code	IEC I _{th}	IEC I _e	IEC I _e	Qty	Wt
GE0050F ❶	50	50	50	1	1.250
GE0125F ❶	125	125	125	1	1.700
With NH fuse holder ❸.					
Separately purchase the handle and shaft extension ❶❷.					
GE0160N	160	160	125	1	1.700
GE0161N	160	160	160	1	3.100
GE0250N	250	250	250	1	6.600
GE0400N	400	400	400	1	6.600
GE0630N	630	630	630	1	13.000
GE0800N	800	630	630	1	13.000
With BS fuse holder ❸.					
Separately purchase the handle and shaft extension ❶❷.					
GE0160B	160	160	160	1	3.500
GE0200B	200	200	200	1	3.500
GE0250B	250	250	250	1	6.600
GE0315B	315	315	315	1	6.600
GE0400B	400	400	400	1	6.600
GE0630B	630	630	630	1	13.000
GE0800B	800	630	630	1	13.000

- ❶ Refer to the side table for the selection of the handle. A shaft insert is standard-supplied with all direct operating handles so no other shaft extension is required in this case.
- ❷ See table on page 12-42 for the types of fuses.
- ❸ The switch disconnector is standard-supplied with fuse protection shield.
- ❹ Standard supplied with IEC IP20 terminal protection.
- ❺ 250A I_{th}; 200A AC21A ≤500V.

Selection of handles

Refer to the left-hand switch disconnector table for the selection of the handle.
For other accessories see page 12-42.

Direct operating	Door coupling	
	Black	Red/yellow
Black	Black	Red/yellow
GEX65D	GAX66NB	GAX66N
GEX66ND	GEX66NB	GEX66N
GEX67ND	GEX67NB	GEX67N
GEX68ND	GEX68NB	GEX68N

Direct operating	Door coupling	
	Black	Red/yellow
Black	Black	Red/yellow
GEX61D	GEX61NB	GEX61N
Direct operating	Door coupling	
	Black	Red/yellow
Black	Black	Red/yellow
GEX61D	GEX61NB	GEX61N
GEX62D	GEX66NB	GEX66N
GEX63D	GEX67NB	GEX67N
GEX64D	GEX68NB	GEX68N
Direct operating	Door coupling	
	Black	Red/yellow
Black	Black	Red/yellow
GEX62D	GEX66NB	GEX66N
GEX63D	GEX67NB	GEX67N
GEX64D	GEX68NB	GEX68N

General characteristics

- 50A to 1600A
- Available versions: direct operating and door coupling
- Screw fixing: 35mm DIN rail mount adapter kit for GE0160P on page 12-42
- Padlockable in 0 position with no extra accessory.

Operational characteristics

- IEC rated insulation voltage U_i:
 - 1000V for GE0160...GE1600, GE0160P, GE0250N/B...GE0800N/B
 - 800V for GE0050F, GE0125F, GE0160N, GE0161N, GE0160B and GE0200B
- Mechanical life:
 - 30,000 cycles for GE0160...GE0250, GE0160P
 - 20,000 cycles for GE0251...GE0400
 - 10,000 cycles for GE0500...GE1600, GE0050, GE0125F, GE0160N/B...GE0400N/B
 - 5,000 cycles for GE0630N/B and GE0800N/B.

Certifications and compliance

Certifications obtained: EAC.
Compliant with standards: IEC/EN/BS 60947-1, IEC/EN/BS 60947-3.

12 Switch disconnectors

GE series 50A to 1600A.
Four-pole

Four-pole switch disconnectors



GE...T4...

Four-pole switch disconnectors with fuse holder



GE...FT4 - GE...NT4 - GE...BT4

Order code	IEC conventional free air thermal current Ith AC21A (≤500V)	IEC rated operational current Ie		Qty per pkg	Wt [kg]
		AC23A (≤400V)	AC23A (≤500V)		
	[A]	[A]	[A]	n°	
Separately purchase the handle and shaft extension ❶.					
GE0160T4P❶	160	160	125	1	1.000
GE0160T4	160	160	125	1	1.000
GE0200T4	200	160	125	1	1.000
GE0250T4	250❷	160	125	1	1.000
GE0251T4	250	250	200	1	1.900
GE0315T4	315	315	250	1	1.900
GE0400T4	400	400	315	1	2.100
GE0500T4	500	500	400	1	4.500
GE0630T4	630	630	500	1	4.500
GE0800T4	800	800	500	1	4.500
GE1000T4	1000	1000	800	1	7.600
GE1250T4	1250	1000	800	1	7.600
GE1600T4	1600	1000	900	1	20.800

With NFC fuse holder ❸❹.

Separately purchase the handle and shaft extension ❶❷.

GE0050FT4❶	50	50	50	1	1.550
GE0125FT4❶	125	125	125	1	2.200

With NH fuse holder ❺.

Separately purchase the handle and shaft extension ❶❷.

GE0160NT4	160	160	125	1	2.200
GE0161NT4	160	160	160	1	8.000
GE0250NT4	250	250	250	1	8.000
GE0400NT4	400	400	400	1	8.000
GE0630NT4	630	630	630	1	15.000
GE0800NT4	800	630	630	1	15.000

With BS fuse holder ❻.

Separately purchase the handle and shaft extension ❶❷.

GE0160BT4	160	160	160	1	4.000
GE0200BT4	200	200	200	1	4.000
GE0250BT4	250	250	250	1	4.000
GE0315BT4	315	315	315	1	8.000
GE0400BT4	400	400	400	1	8.000
GE0630BT4	630	630	630	1	15.000
GE0800BT4	800	630	630	1	15.000

❶ Refer to the side table for the selection of the handle. A shaft insert is standard-supplied with all direct operating handles so no other shaft extension is required in this case.

❷ See table on page 12-43 also for the types of fuses.

❸ The switch disconnector is standard-supplied with fuse protection shield.

❹ Standard supplied with IEC IP20 terminal protection.

❺ See page 12-67 for technical characteristics.

Selection of handles

Refer to the left-hand switch disconnector table for the selection of the handle.

For the other accessories see page 12-43.

Direct operating	Door coupling	
	Black	Red/yellow
GEX65D	GAX66NB	GAX66N
GEX66ND	GEX66NB	GEX66N
GEX67ND	GEX67NB	GEX67N
GEX68ND	GEX68NB	GEX68N

Direct operating	Door coupling	
	Black	Red/yellow
GEX61D	GEX61NB	GEX61N

Direct operating	Door coupling	
	Black	Red/yellow
GEX61D	GEX61NB	GEX61N
GEX62D	GEX66NB	GEX66N
GEX63D	GEX67NB	GEX67N
GEX64D	GEX68NB	GEX68N

Direct operating	Door coupling	
	Black	Red/yellow
GEX62D	GEX66NB	GEX66N
GEX63D	GEX67NB	GEX67N
GEX64D	GEX68NB	GEX68N

General characteristics

- 50A to 1600A
- 4-pole types (3P+N) with early-make late-break neutral pole
- Available versions: direct operating and door coupling
- Screw fixing: 35mm DIN rail mount adapter kit for GE0160T4P on page 12-43
- Padlockable in 0 position with no extra accessory.

Operational characteristics

- IEC rated insulation voltage Ui:
 - 1000V for GE0160T4...GE1600T4, GE0160T4P, GE0250...GE0800NT4/BT4
 - 800V for GE0160NT4/BT4, GE0050FT4, GE0125FT4, GE0161NT4, GE0200BT4.
- Mechanical life:
 - 30,000 cycles for GE0160T4...GE0250T4, GE0160T4P
 - 20,000 cycles for GE0251T4...GE0400T4
 - 10,000 cycles for GE0500T4...GE1600T4, GE0050FT4, GE0125FT4, GE0160...GE0400NT4/BT4.
 - 5,000 cycles for GE0630BT4/BT4 and GE0800NT4/BT4.

Certifications and compliance

Certifications obtained: EAC.
Compliant with standards: IEC/EN/BS 60947-1, IEC/EN/BS 60947-3.

12 Switch disconnectors

GE series 50A to 3150A.
Changeover switches

Three-pole changeover switches

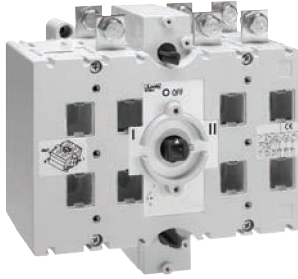

GE...E

Order code	IEC conventional free air thermal current I _{th} AC21A (≤500V)	IEC rated operational current I _e		Qty per pkg	Wt [kg]
		AC23B (≤400V)	AC23B (≤500V)		
	[A]	[A]	[A]	n°	[kg]

Separately purchase the handle and shaft extension ❶.

GE0160E	160	160	125	1	1.800
GE0200E	200	160	125	1	1.900
GE0201E	200	160	125	1	4.800
GE0250E	250	180	150	1	4.800
GE0315E	315	200	160	1	5.000
GE0400E	400	250	200	1	5.000
GE0500E	500	400	250	1	11.500
GE0630E	630	500	315	1	11.500
GE0800E	800	630	400	1	11.900
GE1000E	1000	1000	800	1	21.800
GE1250E	1250	1000	900	1	23.600
GE1600E	1600	1000	900	1	50.000
GE2000E	2000	2000	2000	1	52.000
GE2500E	2500	2500	2500	1	119.000
GE3150E	3150	3150	3150	1	139.000

new

Four-pole changeover switches

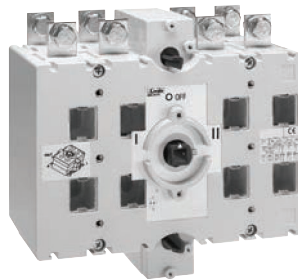

GE...ET4

Order code	IEC conventional free air thermal current I _{th} AC21A (≤500V)	IEC rated operational current I _e		Qty per pkg	Wt [kg]
		AC23B (≤400V)	AC23B (≤500V)		
	[A]	[A]	[A]	n°	[kg]

Separately purchase the handle and shaft extension ❶.

GE0160ET4	160	160	125	1	2.100
GE0200ET4	200	160	125	1	2.200
GE0201ET4	200	160	125	1	5.300
GE0250ET4	250	180	150	1	5.300
GE0315ET4	315	200	160	1	5.500
GE0400ET4	400	250	200	1	5.500
GE0500ET4	500	400	250	1	12.600
GE0630ET4	630	500	315	1	12.600
GE0800ET4	800	630	400	1	13.200
GE1000ET4	1000	1000	800	1	24.300
GE1250ET4	1250	1000	900	1	26.700
GE1600ET4	1600	1000	900	1	55.000
GE2000ET4	2000	2000	2000	1	69.000
GE2500ET4	2500	2500	2500	1	159.000
GE3150ET4	3150	3150	3150	1	186.000

new

❶ Refer to the side table for the selection of the handle. A shaft insert is standard-supplied with all direct operating handles so no other shaft extension is required in this case.

Selection of handles

Refer to the left-hand changeover switch table for the selection of the handle.
For the other accessories see pages 12-41.

Direct operating	Door coupling
Black	Black

GEX61E	GEX61NC
GEX62NE	GEX62NC
GEX63NE	GEX63NC
GEX64NE	GEX64NC
GEX641NE	GEX641NC
GEX69ND	GEX69NB

Selection of handles

Refer to the left-hand changeover switch table for the selection of the handle.
For the other accessories see pages 12-41.

Direct operating	Door coupling
Black	Black

GEX61E	GEX61NC
GEX62NE	GEX62NC
GEX63NE	GEX63NC
GEX64NE	GEX64NC
GEX641NE	GEX641NC
GEX69ND	GEX69NB

General characteristics

- 160A to 3150A
- 4-pole types (3P+N) with early-make late-break neutral pole
- Available versions: direct operating and door coupling
- Screw fixing
- Padlockable in 0 position with no extra accessory.

Operational characteristics

- IEC rated insulation voltage U_i: 1000V
- Mechanical life: 30,000 cycles for GE0160E/ET4 and GE0200E/ET4 only; 10,000 cycles for other types.

Certifications and compliance

Certifications obtained: EAC.
Compliant with standards: IEC/EN/BS 60947-1, IEC/EN/BS 60947-3.

12 Switch disconnectors

GE series 50A to 3150A.
Add-on blocks and accessories



GEX10...



GEX8900



GEX8...



GEX691C



GEX69...

Order code	Description	Qty per pkg	Wt [kg]
		n°	[kg]

Auxiliary contacts ①②.

GEX1011①②	1NO/1NC changeover	1	0.032
GEX1022	2NA/2NC changeover	1	0.032

Auxiliary contacts for switch disconnector types GE0050F, GE0050FT4, GE0125F, GE0125FT4, GE0160N and GE0160NT4.

GEX1011N②	1NO/1NC changeover	1	0.024
GEX1022N	2NA/2NC changeover	1	0.024

Auxiliary contacts for switch disconnector types GE0160E, GE0200E, GE0160ET4, GE0200ET4, GE1600E and GE1600ET4.

GEX1011M②	1NO/1NC changeover	1	0.016
------------------	--------------------	---	-------

Adapter kit for 35mm DIN fixing.

GEX8900	For GE...P types only	1	0.040
----------------	-----------------------	---	-------

Set of terminal covers consisting of pieces given below. See pages from 12-41 to 12-43 and 12-47 for choice according to switch disconnector type. Screw fixing.

GEX8101	1-piece set, transparent sheet covering 4 poles	1	0.048
GEX8111	2-piece set, each covers two poles	1	0.080
GEX8121	2-piece set, each covers two poles	1	0.140
GEX8131	2-piece set, each covers two poles	1	0.170
GEX8141	2-piece set, each covers two poles	1	0.440

Snap-on fixing.

GEX8201	3-piece set, each covers one pole	1	0.090
GEX8203	4-piece set, each covers one pole	1	0.120
GEX8211	3-piece set, each covers one pole	1	0.120
GEX8212	3-piece set, each covers one pole	1	0.120
GEX8213	4-piece set, each covers one pole	1	0.160
GEX8221	3-piece set, each covers one pole	1	0.240
GEX8222	3-piece set, each covers one pole	1	0.240
GEX8223	4-piece set, each covers one pole	1	0.320
GEX8231	3-piece set, each covers one pole	1	0.340
GEX8232	3-piece set, each covers one pole	1	0.340
GEX8233	4-piece set, each covers one pole	1	0.440
GEX8311	3-piece set, each covers one pole	1	0.120
GEX8312	4-piece set, each covers one pole	1	0.160
GEX8321	3-piece set, each covers one pole	1	0.260
GEX8322	4-piece set, each covers one pole	1	0.340
GEX8331	3-piece set, each covers one pole	1	0.360
GEX8332	4-piece set, each covers one pole	1	0.460

Motorised control unit for changeover switches. Rated auxiliary supply voltage 230VAC. Complete with control handle, shaft extension and fixing elements.

GEX690C	For GE0160E...GE0200E and GE0160ET4...GE0200ET4	1	3.000
GEX691C	For GE0201E...GE0400E and GE0201ET4...GE0400ET4	1	3.000
GEX692C	For GE0500E...GE0800E and GE0500ET4...GE0800ET4	1	3.000
GEX693C	For GE1000E...GE1250E and GE1000ET4...GE1250ET4	1	5.753
GEX694C	For GE1600...2000E and GE1600...2000ET4	1	5.900
GEX695C	For GE2500...3150E and GE2500...3150ET4	1	5.900

① Unsuitable for switch disconnectors type GE0050F, GE0050FT4, GE0125F, GE0125FT4, GE0160N, GE0160NT4, GE0160E, GE0200E, GE0160ET4, GE0200ET4, GE1600E and GE1600ET4.

② Changeover contact.

Selection of add-on contacts and accessories

Refer to the combinations given on pages 12-41 to 43 and 12-47 for a correct choice based on the switch disconnector type used.

General characteristics for auxiliary contacts

IEC conventional free air thermal current I_{th}: 16A.

General characteristics for motorised control units

- IEC rated auxiliary supply voltage: 230VAC
- 4 static outputs, 24VDC 120mA total
- 4 inputs, contacts powered at 24VDC or 5VDC (500mA) for changeover control (pulsed or continuous)
- RS485-Modbus (only for GEX692C, GEX693C and GEX694C) serial port for control, monitoring, programming
- Padlockable at 0 position
- Programming by position inputs
- 4-digit display for status-error indications.

Certifications and compliance

Certifications obtained: EAC.

Compliant with standards: IEC/EN/BS 60947-1, IEC/EN/BS 60947-3.

12 Switch disconnectors

GE series 50A to 3150A.
Handles and shaft extensions



GEX...D - GEX...E



GEX62NE

new



GAX66N

new



GEX66N



GEX68N

new



GEX67NB

new



GAX7...AN



GEX7...

For the correct choice of handles and shaft extensions with switch disconnector see tables on pages 12-41 to 12-43.

Order code	Characteristics	Qty per pkg	Wt
		n°	[kg]

DIRECT OPERATING LEVER HANDLE, PADLOCKABLE ❶.
Rotating type with screw fixing on switch disconnector.
Complete with shaft extension.

GEX61D	95mm/3.7" black lever	1	0.340
GEX61E	50mm/2" black lever	1	0.052
GEX62D	105mm/4.1" black lever	1	0.268
GEX62NE	143mm/5.6" black lever	1	0.266
GEX63D	245mm/9.6" black lever	1	0.536
GEX63NE	176mm/6.9" black lever	1	0.424
GEX64D	360mm/14.2" black lever	1	0.612
GEX64NE	396mm/15.6" black lever	1	0.612
GEX641NE	396mm/15.6" black lever	1	0.620
GEX65D	50mm/2" black lever	1	0.054
GEX66ND	115mm/4.5" black lever	1	0.216
GEX67ND	143mm/5.6" black lever	1	0.322
GEX68ND	396mm/15.6" black lever	1	0.328
GEX69ND	604mm/25.2" black lever	1	0.740

DOOR COUPLING LEVER HANDLE, PADLOCKABLE ❶.
Red/yellow rotating type with screw fixing on door.
Shaft extension to order separately ❶.
Defeatable (requirement UL508A).

GAX66N	65mm/2.6" lever. □ 7mm/0.3" ❷. IP66	1	0.075
GEX61N	94mm/3.7" lever. □ 7mm/0.3". IP65	1	0.326
GEX66N	115mm/4.5" lever. □ 10mm/0.4". IP65	1	0.248
GEX67N	143mm/5.6" lever. □ 14mm/0.6". IP65	1	0.302
GEX68N	396mm/15.6" lever. □ 14mm/0.6". IP65	1	0.312

DOOR COUPLING LEVER HANDLE, PADLOCKABLE ❶.
Black rotating type with screw fixing on door.
Shaft extension to order separately ❶.
Defeatable (requirement UL508A).

GAX66NB	65mm/2.6". □ 7mm/0.3" ❷. IP66	1	0.075
GEX61NB	94mm/3.7". □ 7mm/0.3". IP65	1	0.334
GEX61NC	94mm/3.7". □ 7mm/0.3". IP65	1	0.074
GEX62NC	143mm/5.6". □ 10mm/0.4". IP65	1	0.252
GEX63NC	176mm/6.9". □ 14mm/0.6". IP65	1	0.302
GEX64NC	396mm/15.6". □ 14mm/0.6". IP65	1	0.488
GEX641NC	396mm/15.6". □ 14mm/0.6". IP65	1	0.500
GEX66NB	115mm/4.5". □ 10mm/0.4". IP65	1	0.246
GEX67NB	143mm/5.6". □ 14mm/0.6". IP65	1	0.298
GEX68NB	396mm/15.6". □ 14mm/0.6". IP65	1	0.310
GEX69NB	604mm/25.2". □ 14mm/0.6". IP65	1	0.740

SHAFT EXTENSIONS for door coupling handles ❶.

GAX7150AN	150mm/5.9", □ 7mm/0.3"	1	0.090
GAX7200AN	200mm/7.9", □ 7mm/0.3"	1	0.112
GAX7300AN	300mm/11.8", □ 7mm/0.3"	1	0.160
GAX7400AN	400mm/15.7", □ 7mm/0.3"	1	0.200
GAX7500AN	500mm/19.7", □ 7mm/0.3"	1	0.250
GEX7162N	177mm/7", □ 7mm/0.3"	1	0.056
GEX7195N	195mm/7.7", □ 14mm/0.6"	1	0.248
GEX7227N	227mm/8.9", □ 10mm/0.4"	1	0.154
GEX7239N	239mm/9.4", □ 14mm/0.6"	1	0.310
GEX7250N	250mm/9.8", □ 7mm/0.3"	1	0.084
GEX7345N	345mm/13.6", □ 14mm/0.6"	1	0.480
GEX7375N	375mm/14.7", □ 10mm/0.4"	1	0.274
GEX7387N	387mm/15.2", □ 7mm/0.3"	1	0.142
GEX7536N	536mm/21.1", □ 10mm/0.4"	1	0.408
GEX7535N	535mm/21", □ 14mm/0.6"	1	0.784
GEX7485N	485mm/19.1", □ 14mm/0.6"	1	0.930

Certifications and compliance

Certification obtained: cULus according to UL98A/CSA C22.2 no. 4 only for types GAX66N... and GAX7...AN; EAC for all.

Compliant with standards: IEC/EN/BS 60947-1, IEC/EN/BS 60947-3.

Form and handle length	Handle types
50mm/2"	GEX61E - GEX65D
65mm/2.6"	GAX66N - GAX66NB
94mm/3.7"	GEX61N - GEX61NB GEX61NC
95mm/3.74"	GEX61D
105mm/4.1"	GEX62D
115mm/4.5"	GEX66ND - GEX66NB GEX66N
143mm/5.6"	GEX62NC - GEX62NE GEX67N - GEX67NB GEX67ND
176mm/6.9"	GEX63NC - GEX63NE
245mm/9.6"	2-hand GEX63D
360mm/14.2"	2-hand GEX64D
396mm/15.6"	2-hand GEX64NC - GEX64NE - GEX641NC - GEX641NE - GEX68N - GEX68NB - GEX68ND
604mm/25.2"	2-hand GEX69ND - GEX69NB

❶ See tables on pages 12-41 to 43 and 12-47 for the correct choice based on the switch disconnector type used.
❷ 2-hand control.
❸ Use with GAX7...AN extension types only.

Summary table of combinations - Three and four-pole changeover switches

Type	IEC conventional thermal current Ith		Direct operating handle			Door coupling handles		Shaft extensions for door coupling handles (the last 3 digits of GEX code indicate length in mm/in)		Auxiliary contacts 1NO/1NC	Motorised control unit	Terminal covers for:		
	AC21A (≤500V)	AC23B (≤400V)	AC23B (≤500V)	Black	Black	Red/yellow	Exten. section	Max panel depth	Line 1			Line 2	Load	
Order code	[A]	[A]	[A]	Order code	Order code	Order code	Order code	<input type="checkbox"/>	[mm/in]	Order code	Order code	Order code	Order code	Order code

Three-pole changeover switches.

GE0160E	160	160	125	GEX61E	GEX61NC	—	GEX7162N	7mm/ 0.3"	269/10.59"	GEX1011M	GEX690C	GEX8101	①	GEX8101
GE0200E	200	160	125				GEX7250N		342/13.36"			①		
							GEX7387N		479/18.86"					
GE0201E	200	160	125	GEX62NE	GEX62NC	—	GEX7227N	10mm/ 0.4"	279/10.98"	GEX1011	GEX691C	GEX8212	GEX8211	GEX8311
GE0250E	250	180	150				GEX7375N		427/16.81"					
GE0315E	315	200	160				GEX7536N		588/23.15"					
GE0400E	400	250	200											
GE0500E	500	400	250	GEX63NE	GEX63NC	—	GEX7195N	14mm/ 0.6"	257/10.12"		GEX692C	GEX8222	GEX8221	GEX8321
GE0630E	630	500	315				GEX7345N		407/16.02"					
GE0800E	800	630	400				GEX7535N		597/23.50"					
GE1000E	1000	1000	800	GEX64NE	GEX64NC	—			280/11.02"		GEX693C	GEX8232	GEX8231	GEX8331
GE1250E	1250	1000	900						430/16.93"					
									620/24.41"					
GE1600E	1600	1000	900			—	GEX7239N	14mm/ 0.6"	579/22.79"	GEX1011M	GEX694C	GEX8141	—	GEX8141
							GEX7485N		825/32.48"					
GE2000E	2000	1250	500	GEX41NE	GEX41NC	—	②	—	602/23.7"		GEX694C	—	—	—
GE2500E	2500	1800	1250	GEX69ND	GEX69NB	—	②	—	938/36.9"		GEX695C	—	—	—
GE3150E	3150	1800	1400			—	②	—			GEX695C	—	—	—

Four-pole changeover switches.

GE0160ET4	160	160	125	GEX61E	GEX61NC	—	GEX7162N	7mm/ 0.3"	269/10.59"	GEX1011M	GEX690C	GEX8101	①	GEX8101
GE0200ET4	200	160	125				GEX7250N		342/13.36"			①		
							GEX7387N		479/18.86"					
GE0201ET4	200	160	125	GEX62NE	GEX62NC	—	GEX7227N	10mm/ 0.4"	279/10.86"	GEX1011	GEX691C	GEX8213	GEX8213	GEX8312
GE0250ET4	250	180	150				GEX7375N		427/16.81"					
GE0315ET4	315	200	160				GEX7536N		588/23.15"					
GE0400ET4	400	250	200											
GE0500ET4	500	400	250	GEX63NE	GEX63NC	—	GEX7195N	14mm/ 0.6"	257/10.12"		GEX692C	GEX8223	GEX8223	GEX8322
GE0630ET4	630	500	315				GEX7345N		407/16.02"					
GE0800ET4	800	630	400				GEX7535N		597/23.50"					
GE1000ET4	1000	1000	800	GEX64NE	GEX64NC	—			280/11.02"		GEX693C	GEX8233	GEX8233	GEX8332
GE1250ET4	1250	1000	900						430/16.93"					
									620/24.41"					
GE1600ET4	1600	1000	900			—	GEX7239N	14mm/ 0.6"	579/22.79"	GEX1011M	GEX694C	GEX8141	—	GEX8141
							GEX7485N		825/32.48"					
GE2000ET4	2000	1250	500	GEX641NE	GEX641NC	—	②	—	602/23.7"		GEX694C	—	—	—
GE2500ET4	2500	1800	1250	GEX641NE	GEX641NC	—	②	—	938/36.9"		GEX695C	—	—	—
GE3150ET4	3150	1800	1400			—	②	—			GEX695C	—	—	—

① GEX8101 terminal cover protects the input of both Line 1 and Line 2; nothing else is required for Line 2.

② Extension shaft already included in the door coupling handle.

Summary table of combinations - Three-pole switch disconnectors

Three pole type ①	IEC conventional free air thermal current I _{th}		IEC rated operational current I _e		Direct operating handle	Door coupling handles		Shaft extensions for door coupling handles (the last 3 digits of GEX code indicate length in mm/in)		Auxiliary contacts 1NO/1NC	Type of fuse	Terminal covers for:	
	AC21A (≤500V)	AC23A (≤400V)	AC23A (≤500V)	Black	Black	Red/yellow	Exten. section	Max panel depth	Order code	Line	Load		

Switch disconnectors.

Order code	[A]	[A]	[A]	Order code	Order code	Order code	Order code	<input type="checkbox"/>	[mm/in]	Order code	Order code	Order code	Order code
GE0160P Ⓣ	160	160	125	GEX65D	GAX66NB	GAX66N	GAX7150AN Ⓣ	7mm/0.3"	214/8.42"	GEX1011	—	GEX8101	GEX8101
GE0160	160	160	125				GAX7200AN Ⓣ		264/10.39"				
GE0200	200	160	125				GAX7300AN Ⓣ		364/14.33"				
GE0250	250	160	125				GAX7400AN Ⓣ						
							GAX7500AN Ⓣ						
GE0251	250	250	200	GEX66ND	GEX66NB	GEX66N	GEX7227N	10mm/0.4"	267/10.51"			GEX8111	GEX8111
GE0315	315	315	250				GEX7375N		415/16.34"				
GE0400	400	400	315				GEX7536N		576/22.68"				
GE0500	500	500	400	GEX67ND	GEX67NB	GEX67N	GEX7195N	14mm/0.6"	251/9.88"			GEX8121	GEX8121
GE0630	630	630	500				GEX7345N		401/15.79"				
GE0800	800	800	500				GEX7535N		591/23.27"				
GE1000	1000	1000	800	GEX68ND	GEX68NB	GEX68N			267/10.51"			GEX8131	GEX8131
GE1250	1250	1000	800						417/16.42"				
									607/23.90"				
GE1600	1600	1000	900				GEX7239N	14mm/0.6"	399/15.71"			GEX8141	GEX8141
							GEX7485N		645/25.39"				

Switch disconnectors with NFC fuse holder.

Order code	[A]	[A]	[A]	Order code	Order code	Order code	Order code	<input type="checkbox"/>	[mm/in]	Order code	Order code	Order code	Order code
GE0050F Ⓣ	50	50	50	GEX61D	GEX61NB	GEX61N	GEX7162N	7mm/0.3"	192/7.56"	GEX1011N	14x51	Ⓣ	Ⓣ
GE0125F Ⓣ	125	125	125				GEX7250N		265/10.43"		22x58		
							GEX7387N		402/15.83"				

Switch disconnectors with NH fuse holder.

Order code	[A]	[A]	[A]	Order code	Order code	Order code	Order code	<input type="checkbox"/>	[mm/in]	Order code	Order code	Order code	Order code
GE0160N	160	160	125	GEX61D	GEX61NB	GEX61N	GEX7162N	7mm/0.3"	192/7.56"	GEX1011N	00	GEX8201	GEX8201
							GEX7250N		265/10.43"				
							GEX7387N		402/15.83"				
GE0161N	160	160	160	GEX62D	GEX66NB	GEX66N	GEX7227N	10mm/0.4"	302/11.89"	GEX1011	0	GEX8211	GEX8212
							GEX7375N		450/11.72"				
							GEX7536N		611/24.05"				
GE0250N	250	250	250	GEX63D	GEX67NB	GEX67N	GEX7195N	14mm/0.6"	271/10.67"		1	GEX8221	GEX8222
GE0400N	400	400	400				GEX7345N		421/16.57"		2		
							GEX7535N		611/24.05"				
GE0630N	630	630	630	GEX64D	GEX68NB	GEX68N			285/11.22"		3	GEX8231	GEX8232
GE0800N	800	630	630						435/17.12"				
									625/24.61"				

Switch disconnectors with BS fuse holder.

Order code	[A]	[A]	[A]	Order code	Order code	Order code	Order code	<input type="checkbox"/>	[mm/in]	Order code	Order code	Order code	Order code
GE0160B	160	160	160	GEX62D	GEX66NB	GEX66N	GEX7227N	10mm/0.4"	302/11.89"	GEX1011	A4	GEX8211	GEX8212
GE0200B	200	200	200				GEX7375N		450/11.72"		B1-B2		
GE0250B	250	250	250				GEX7536N		611/24.05"				
GE0315B	315	315	315	GEX63D	GEX67NB	GEX67N	GEX7195N	14mm/0.6"	271/10.67"		B1-B2-B3	GEX8221	GEX8222
GE0400B	400	400	400				GEX7345N		421/16.57"		B1-B2-B3-B4		
							GEX7535N		611/24.05"				
GE0630B	630	630	630	GEX64D	GEX68NB	GEX68N			285/11.22"		C1-C2	GEX8231	GEX8232
GE0800B	800	630	630						435/17.12"		C1-C2-C3		
									625/24.61"				

- ① The motorised control unit cannot be installed.
- ② Standard supplied with IP20 terminal protection warranted by wired equipment with only maximum conductor section of 95mm². Suitable for mounting on 35mm DIN rail, GEX8900 kit is available on page 12-39.
- ③ Standard supplied with IEC IP20 terminal protection warranted by wired equipment with only maximum conductor section of 35mm² for GE0050F and of 95mm² for GE0125F.
- ④ Extension length for type GAX7150AN is 186mm/7.32", type GAX7200AN 236mm/9.29", type GAX7300AN 336mm/13.23", type GAX7400AN 436mm/17.16" and type GAX7500AN 536mm/21.10".

Summary table of combinations - Four-pole switch disconnectors

Four pole type ①	IEC conventional free air thermal current Ith			Direct operating handle	Door coupling handles		Shaft extensions for door coupling handles (the last 3 digits of GEX code indicate length in mm/in)		Auxiliary contacts 1NO/1NC	Type of fuse	Terminal covers for:		
	AC21A (≤500V)	AC23A (≤400V)	AC23A (≤500V)	Black	Black	Red/yellow	Exten. section	Max panel depth			Line	Load	
Order code	[A]	[A]	[A]	Order code	Order code	Order code	Order code	<input type="checkbox"/>	[mm/in]	Order code		Order code	Order code

Switch disconnectors.

GE0160T4P ②	160	160	125	GEX65D	GAX66NB	GAX66N	GAX7150AN ③ GAX7200AN ③ GAX7300AN ③ GAX7400AN ③ GAX7500AN ③	7mm/ 0.3"	214/8.42" 264/10.39" 364/14.33"	GEX1011	—	④ GEX8101	④ GEX8101
GE0160T4	160	160	125										
GE0200T4	200	160	125										
GE0250T4 ⑤	250	160	125										
GE0251T4	250	250	200	GEX66ND	GEX66NB	GEX66N	GEX7227N GEX7375N GEX7536N	10mm/ 0.4"	267/10.51" 415/16.34" 576/22.68"			GEX8111	GEX8111
GE0315T4	315	315	250										
GE0400T4	400	400	315										
GE0500T4	500	500	400	GEX67ND	GEX67NB	GEX67N	GEX7195N GEX7345N GEX7535N	14mm/ 0.6"	251/9.88" 401/15.79" 591/23.27"			GEX8121	GEX8121
GE0630T4	630	630	500										
GE0800T4	800	800	500										
GE1000T4	1000	1000	800	GEX68ND	GEX68NB	GEX68N			267/10.51" 417/16.42"			GEX8131	GEX8131
GE1250T4	1250	1000	800						607/23.90"				
GE1600T4	1600	1000	900				GEX7239N GEX7485N	14mm/ 0.6"	399/15.71" 645/25.39"			GEX8141	GEX8141

Switch disconnectors with NFC fuse holder.

GE0050FT4 ⑥	50	50	50	GEX61D	GEX61NB	GEX61N	GEX7162N GEX7250N GEX7387N	7mm/ 0.3"	192/7.56" 265/10.43" 402/15.83"	GEX1011N	14x51 22x58	④	④
GE0125FT4 ⑥	125	125	125										

Switch disconnectors with NH fuse holder.

GE0160NT4	160	160	125	GEX61D	GEX61NB	GEX61N	GEX7162N GEX7250N GEX7387N	7mm/ 0.3"	192/7.56" 265/10.43" 402/15.83"	GEX1011N	00	GEX8203	GEX8203
GE0161NT4	160	160	160	GEX62D	GEX66NB	GEX66N	GEX7227N GEX7375N GEX7536N	10mm/ 0.4"	302/11.89" 450/17.72" 611/24.05"	GEX1011	0	GEX8213	GEX8213
GE0250NT4	250	250	250	GEX63D	GEX67NB	GEX67N	GEX7195N GEX7345N GEX7535N	14mm/ 0.6"	271/10.67" 421/16.57" 611/24.05"		1	GEX8223	GEX8223
GE0400NT4	400	400	400								2		
GE0630NT4	630	630	630	GEX64D	GEX68NB	GEX68N			285/11.22"		3	GEX8233	GEX8233
GE0800NT4	800	630	630						435/17.12" 625/24.61"				

Switch disconnectors with BS fuse holder.

GE0160BT4	160	160	160	GEX62D	GEX66NB	GEX66N	GEX7227N GEX7375N GEX7536N	10mm/ 0.4"	302/11.89" 450/17.72" 611/24.05"	GEX1011	A4 B1-B2	GEX8213	GEX8213
GE0200BT4	200	200	200										
GE0250BT4	250	250	250										
GE0315BT4	315	315	315	GEX63D	GEX67NB	GEX67N	GEX7195N GEX7345N GEX7535N	14mm/ 0.6"	271/10.67" 421/16.57" 611/24.05"		B1-B2-B3 B1-B2-B3-B4	GEX8223	GEX8223
GE0400BT4	400	400	400										
GE0630BT4	630	630	630	GEX64D	GEX68NB	GEX68N			285/11.22"		C1-C2	GEX8233	GEX8233
GE0800BT4	800	630	630						435/17.12" 625/24.61"		C1-C2-C3		

① The motorised control unit cannot be installed.

② Standard supplied with IP20 terminal protection warranted by wired equipment with only maximum conductor section of 95mm². Suitable for mounting on 35mm DIN rail, GEX89 00 kit is available on page 12-39.

③ 250A Ith; 200A AC21A ≤500V.

④ Standard supplied with IEC IP20 terminal protection warranted by wired equipment with only maximum conductor section of 35mm² for GE0050FT4 and of 95mm² for GE0125FT4.

⑤ Extension length for type GAX7150AN is 186mm/7.32", type GAX7200AN 236mm/9.29", type GAX7300AN 336mm/13.23", type GAX7400AN 436mm/17.16" and type GAX7500AN 536mm/21.10".

12 Fusible disconnect switches (UL98)

GM series 30A to 800A



INDEX

Three-pole disconnect switches with fuse holder (UL98)



GMF...030C12



GMFJ100C03



GMFJ400C03



GMFL800C03

Order code	General purpose current	UL fuse type	Command pole position	Qty per pkg	Wt
	[A]	[A]		n°	[kg]

Supplied without handle.
Complete the disconnect switch by selecting shaft extension and handle for door coupling version or the handle for direct operating version (see page 12-45).

GMFC030C12	30	CC	Central	1	0.700
GMFJ030C12	30	J	Central	1	0.700
GMFJ060C12	60	J	Central	1	1.135
GMFJ060C03	60	J	Left	1	1.135
GMFJ100C03	100	J	Left	1	1.815
GMFJ200C03	200	J	Left	1	3.000
GMFJ400C03	400	J	Left	1	6.800
GMFJ600C03	600	J	Left	1	13.00
GMFL800C03	800	L	Left	1	13.00

UL/CSA ratings

Type	1 phase [HP]		3 phase [HP]			Short-circuit rating at 600VAC [kA]	Fuse type	
	120V	240V	240V	480V	600V		[A]	[class]
GMFC030C12	2	3	7.5	15	20	200	30	CC
GMFJ030C12	2	3	7.5	15	20	200	30	J
GMFJ060C12	-	-	15	30	50	200	60	J
GMFJ060C03	-	-	15	30	50	200	60	J
GMFJ100C03	-	-	30	60	75	200	100	J
GMFJ200C03	-	-	60	125	150	200	200	J
GMFJ400C03	-	-	125	250	350	200	400	J
GMFJ600C03	-	-	200	400	500	200	600	J
GMFL800C03	-	-	250	500	500	200	800	L

Add-on blocks



GMX1010



GMX3...



GMX800
GMX801



GMX802
GMX803
GMX804



GMX5...



GMXFM...

- ① Only for GMF...030 types.
- ② For all GM switch disconnectors. Suitable for 1 or 3 phase circuits. Includes 1 NO and 1 NC auxiliary contacts and red/green LED lights for indication.

Order code	Description	Qty per pkg	Wt
		n°	[kg]

Auxiliary contacts, mounting to the switch mechanism.

GMX1011①	1NO/NC changeover	1	0.020
GMX1010	1NO	1	0.030
GMX1001	1NC	1	0.030

Module for auxiliary contacts mounting on the side of the switch mechanism.

GMX33	For GMF...030 types	1	0.060
GMX34	For GMF...60 to GMF...800 types	1	0.065

Terminal covers.

GMX800	3-piece set, each covers 1 pole for GMFJ100C03	1	0.080
GMX801	3-piece set, each covers 1 pole for GMFJ200C03	1	0.090
GMX802	1-piece set, covers 3 poles for GMFJ400C03	1	0.080
GMX803	1-piece set, covers 3 poles for GMFJ600C03	1	0.080
GMX804	1-piece set, covers 3 poles for GMFL800C03	1	0.080

Terminal clamp sets for rigid and flexible cables.

GMX500	6-piece set for GMFJ100C03	1	0.200
GMX501	6-piece set for GMFJ200C03	1	0.200
GMX502	6-piece set for GMFJ400C03	1	0.500
GMX503	6-piece set for GMFJ400C03	1	1.000
GMX504	6-piece set for GMFJ600C03 and GMFL800C03	1	1.600

Fuse monitor modules ②.

GMXFM1	Rated voltage 120...240V	1	0.145
GMXFM2	Rated voltage 380...600V	1	0.140

Crimp terminals for fuse monitor GMXF... cables.

GMX505	6-piece set. Terminal size 2.8-0.8mm/0.11-0.03"	1	0.004
--------	---	---	-------

General characteristics

- General purpose current according to UL98: 30A to 800A
- Compact dimensions
- Available versions: direct operating and door coupling
- Screw or 35mm DIN rail fixing for GMF...030 types
- Possibility to adjust the position of the clips for fixing screw on plate for GMF...060 to GMF...800 types.

Operational characteristics

- IEC rated insulation voltage U_i : 1000V
- UL max operating voltage: 600V
- IEC rated impulse withstand U_{imp} : 12kV
- Mechanical life:
 - 10,000 cycles for GMF...030 and GMF...060
 - 8,000 cycles for GMFJ100C03 and GMFJ200C03
 - 5,000 cycles for GMFJ400C03 and GMFJ600C03
 - 3,000 cycles for GMFL800C03.

Certifications and compliance

Certifications obtained: cULus according to UL98 / CSA C22.2 n°4.
Compliant with standards: IEC/EN/BS 60947-3, IEC/EN/BS 60947-1.

GMF...C12 type

Central command pole

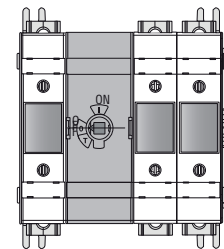

GMF...C03 type

Left command pole

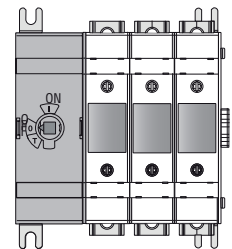

Operational characteristics of auxiliary contacts GMX1011

- IEC conventional free air thermal current I_{th} : 10A
- IEC rated insulation voltage: 400V
- Conductivity: 12V, 25mA
- Tightening torque: 0.8Nm/7.1lb.in
- Maximum 6 contacts for GMF...030 disconnect switches.

Operational characteristics of auxiliary contacts GMX1010/01

- IEC/UL conventional free air thermal current I_{th} : 16A/10A
- IEC/UL rated insulation voltage: 690V/600V
- Conductivity: 24V, 10mA
- UL/CSA and IEC/EN 60947-5-1 designation: A600 R300
- Tightening torque: 0.8Nm/7.1lb.in
- Maximum 8 contacts for GMF...060 to GMFL800 disconnect switches.

Operational characteristics for terminal clamps

- Minimum and maximum conductor cross section:
 - GMX500: 2.5...70mm² / 14-2/0AWG
 - GMX501: 25...150mm² / 4-300Kcmil
 - GMX502: 35...300mm² / 2-600Kcmil
 - GMX503: (2)x 35...150mm² / (2)x 6-300Kcmil
 - GMX504: (2)x 35...300mm² / (2)x 2-600Kcmil
- Tightening torque:
 - GMX500: 13Nm / 120lb.in.
 - GMX501: 22Nm / 200lb.in.
 - GMX502: 42Nm / 375lb.in.
 - GMX503: 22Nm / 200lb.in.
 - GMX504: 22.6Nm / 200lb.in.

Operational characteristics for terminal covers

- Snap-on mounting.

Certifications and compliance

Certifications obtained: cULus for GMX1010, GMX1001, GMXFM1 and GMXFM2.
Compliant with standards: IEC/EN/BS 60947-3, IEC/EN/BS 60947-1.

12 Fusible disconnect switches (UL98)

GM series 30A to 800A.
Accessories

Handles and shafts



GMX62DB



GMX62



GLX00



GMX7...S06

NFPA handle



GMX61NFPA



GMXCL...

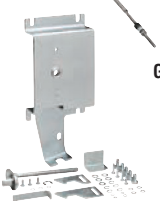

GMX30

Order code	Characteristics	Qty per pkg	Wt
		n°	[kg]
Direct operating handles.			
GMX61DB	For GMF...030. Black	1	0.050
GMX62DB	For GMFJ060...GMFJ200. Black	1	0.150
GMX63DB	For GMFJ400. Black	1	0.350
GMX64DB	For GMFJ600...GMFL800. Black	1	1.100
Door coupling handles.			
GAX66N	For GMF...030...GMFJ200. Screw fixing. 65mm/2.56" lever length pistol handle - defeatable (req. UL508A). Red/yellow. □ 6mm/0.24"	1	0.050
GAX66NB	For GMF...030...GMFJ200. Screw fixing. 65mm/2.56" lever length pistol handle - defeatable (req. UL508A). Black. □ 6mm/0.24"	1	0.050
GMX61	For GMFJ400. Screw fixing. 125mm/4.92" lever length pistol handle - defeatable (req. UL508A). Red/yellow. □ 12mm/0.47"	1	0.050
GMX61B	For GMFJ400. Screw fixing. 125mm/4.92" lever length pistol handle - defeatable (req. UL508A). Black. □ 12mm/0.47"	1	0.200
GMX62	For GMFJ600...GMFL800. Screw fixing. 175mm/6.89" lever length pistol handle - defeatable (req. UL508A). Red/yellow. □ 12mm/0.47"	1	0.200
GMX62B	For GMFJ600...GMFL800. Screw fixing. 175mm/6.89" lever length pistol handle - defeatable (req. UL508A). Black. □ 12mm/0.47"	1	0.200
Accessories for door coupling handles.			
GLX00	Shaft alignment ring	1	0.040
Shaft extensions for door coupling handles GAX66N and GAX66NB types.			
GMX7150S06	150mm/5.90", □ 6mm/0.24"	1	0.120
GMX7300S06	300mm/11.81", □ 6mm/0.24"	1	0.155
Shaft extensions for door coupling handles GMX61, GMX61B, GMX62 and GMX62B types.			
GMX7150S12	150mm/5.90", □ 12mm/0.47"	1	0.240
GMX7300S12	300mm/11.81", □ 12mm/0.47"	1	0.280
GMX7500S12	500mm/19.68", □ 12mm/0.47"	1	0.310

Order code	Characteristics	Qty per pkg	Wt
		n°	[kg]
Flange handle.			
GMX61NFPA	For GMF...030...GMFJ200. NEMA 4, 4X. Black	1	1.850
Flexible connection cables for GMX61NFPA.			
GMXCL36	Cable length 914mm/36"	1	0.400
GMXCL48	Cable length 1220mm/48"	1	0.500
GMXCL60	Cable length 1520mm/60"	1	0.550
GMXCL72	Cable length 1828mm/72"	1	0.650
Support and operating mechanism for GMX61NFPA.			
GMX30	For GMF...030	1	0.830
GMX31	For GMFJ060C12	1	1.180
GMX32	For GMF...060...GMFJ200	1	1.520

Operational characteristics for direct operating handles

- Screw fixing on disconnect switches
- 1 to 3 padlocks in the Ø5...6.2mm/0.2...0.24".

Operational characteristics for door coupling handles

- Handle fixing centres: 28x40mm/1.1x1.57"
- 1 to 3 padlocks in the Ø4...8mm/0.16...0.31" for all handles
- Tightening torque: 1.5Nm/13.3lb.in
- Degree of protection: IP66 and NEMA 4X per UL.

NOTE: the handles type GAX66N, GAX66NB, GMX61, GMX61B, GMX62, GMX62B are in accordance with UL/CSA Type 1, 2, 3R, 12, 12K, 4, 4X for external use.

Certifications and compliance

Certifications obtained: cULus for GMX62DB, GMX63DB, GMX64DB, GAX66N, GAX66NB, GMX61, GMX61B, GMX62, GMX62B, GLX00, GMX7...
Compliant with standards: IEC/EN/BS 60947-1, IEC/EN/BS 60947-3.

GA series switch disconnectors



GA040D



GAX42...D

Order code	IEC conventional free air thermal current I _{th}	IEC rated operational current I _e DC21B [ⓐ]			Qty per pkg	Wt [kg]
		3 poles 500V	4 poles 600V	800V		
[A]	[A]	[A]	[A]	[A]	n°	[kg]

Switch disconnector complete with black handle.

GA040D	40	12	—	—	1	0.135
---------------	----	----	---	---	---	-------

Fourth pole.

GAX42040D	40	—	20	15	1	0.040
------------------	----	---	----	----	---	-------

- ⓐ Connection of 4 poles in series.
- ⓑ For other operational voltages, refer to technical characteristics on page 12-73.

GD series switch disconnectors



GD040AT4

new

Order code	IEC conventional free air thermal current I _{th}	IEC rated operational current I _e DC21B [ⓐ]				Qty per pkg	Wt [kg]
		≤800V	1000V	1200V	1500V		
[A]	[A]	[A]	[A]	[A]	[A]	n°	[kg]

Switch disconnector complete with black handle.

GD025AT2	25	25	16	—	—	1	0.140
-----------------	----	----	----	---	---	---	-------

GD025AT3	25	25	25	—	—	1	0.180
-----------------	----	----	----	---	---	---	-------

GD032AT3	32	32	32	—	—	1	0.180
-----------------	----	----	----	---	---	---	-------

GD032AT4	32	32	32	25	20	1	0.220
-----------------	----	----	----	----	----	---	-------

GD040AT3	40	40	32	—	—	1	0.180
-----------------	----	----	----	---	---	---	-------

GD040AT4	40	40	40	32	25	1	0.220
-----------------	----	----	----	----	----	---	-------

IEC/EN/BS IP65 plastic enclosed GAZ series switch disconnectors



GAZ016DT2



GAZ040DT4

Order code	IEC conventional thermal current I _{th}	IEC rated operational current I _e DC21B				Qty per pkg	Wt [kg]
		≤800V	1000V	1200V	1500V		
[A]	[A]	[A]	[A]	[A]	[A]	n°	[kg]

With red/yellow handle.

GAZ025DT2	25	25	16	—	—	1	0.450
------------------	----	----	----	---	---	---	-------

GAZ032DT3	32	32	32	—	—	1	1.050
------------------	----	----	----	---	---	---	-------

GAZ040DT4	40	40	40	32	25	1	1.050
------------------	----	----	----	----	----	---	-------

With black handle.

GAZ025DT2B	25	25	16	—	—	1	0.450
-------------------	----	----	----	---	---	---	-------

GAZ032DT3B	32	32	32	—	—	1	1.050
-------------------	----	----	----	---	---	---	-------

GAZ040DT4B	40	40	40	32	25	1	1.050
-------------------	----	----	----	----	----	---	-------

General characteristics

- Up to 40A (1000VDC) and 32A (1200VDC)
- Modular construction
- Jumpers for connecting the poles in series supplied as standard with disconnectors GD series...
- Available versions:
 - Direct operating
 - Door coupling version. Use switch disconnector with direct actuator and separately purchase the handle and shaft extension for this version. See pages 12-14 to 12-16
- Screw or 35mm DIN rail fixing
- Padlockable in 0 position with no extra accessory.

Operational characteristics

- Rated insulation voltage for GA...D and GD...:
 - Ui: 1000V (pollution degree 3)
- Rated insulation voltage for GD...:
 - Ui: 1500V (pollution degree 2)
- Rated impulse withstand U_{imp}: 8kV
- Mechanical life:
 - 100,000 cycles GA040D
 - 10,000 cycles GD...
- Operating temperature: -25°C...+55°C
- Storage temperature: -40°C...+70°C
- Degree of protection: IP20 (only for GA040D).

Certifications and compliance

Certifications obtained: UL Listed for USA and Canada (cULus - File E93602) as Manual Motor Controllers, to UL508/CSA C22.2 n° 14 for GA040D and GAX42040D; EAC for GA...D.

Compliant with standards: IEC/EN/BS 60947-3, IEC/EN/BS 60947-1.

Strokes of GA...D types (main poles and add-on pole)

	Travel 0→1	0°	30°	60°	90°
GA040D Main poles				60°	
GAX42040D Simultaneous fourth-pole add on				60°	

Components

Enclosure	Switch disconnector	Handle included with GAZ...
GAZ1	GD025AT2	GAX61
GAZ2 [ⓐ]	GD032AT3	GAX61
GAZ2 [ⓑ]	GD040AT4	GAX61
GAZ1B	GD025AT2	GAX61B
GAZ2B [ⓐ]	GD032AT3	GAX61B
GAZ2B [ⓑ]	GD040AT4	GAX61B

- ⓐ For further details contact our Technical support; see contact details on inside front cover.

General characteristics

- Enclosure material: ABS
- Possible accessories to mount afterwards, if any required:
 - GAX30 to provide shielded cable connection continuity (e.g. with static converters)
- Padlockable handles
- Sealable cover
- Tightening torque for cover screws:
 - GAZ025...: 1.3Nm/16lb.in
 - Other types: 1.5Nm/13lb.in.
- Degree of protection: IP65
- Cable entry:
 - GAZ025... types: PG16/M25 and PG13.5/M20 knockouts
 - GAZ032... and GAZ040... types: PG16/M25 and PG29/M32 knockouts.

Certifications and compliance

Certifications obtained: EAC
Compliant with standards: IEC/EN/BS 60947-3, IEC/EN/BS 60947-1.

GE series four-pole switch disconnectors



GE...DT4

Order code	IEC conventional free air thermal current I _{th}	IEC rated operational current I _e DC21B ②			Qty per pkg	Wt [kg]
		220V	800V	1000V		
	[A]	[A]	[A]	[A]	n°	[kg]

Direct operating and door coupling versions.
Separately purchase the handle and shaft extension ①.

GE0125DT4	125	125	125	100	1	1.900
GE0250DT4	250	250	250	200	1	2.000
GE0315DT4	315	315	280	250	1	4.000
GE0630DT4	630	630	600	500	1	4.500
GE0800DT4	800	800	630	630	1	4.500
GE1250DT4	1250	1250	1000	850	1	8.900

① Refer to the side table for the selection of the handle. A shaft insert is standard-supplied with all direct operating handles so no other shaft extension is required in this case.

② Connection of 4 poles in series.

Selection of handles and accessories

Refer to the left-hand switch disconnector table for the selection of the handle.

For the other accessories see pages 12-39 and 12-40.

Direct operating Black	Door coupling	
	Black	Red/yellow
GEX66ND	GEX66NB	GEX66N
GEX67ND	GEX67NB	GEX67N
GEX68ND	GEX68NB	GEX68N

General characteristics

- Up to 850A, 1000VAC
- Available versions:
 - Direct operating
 - Door coupling. Use switch disconnector with direct actuator and separately purchase the handle and shaft extension for this version. See page 12-40
- Screw fixing
- Padlockable in 0 position with no extra accessory.

Operational characteristics

- IEC rated insulation voltage U_i: 1000V
- Mechanical life:
 - 20,000 cycles for GE0125DT4, GE0250DT4, GE0315DT4
 - 10,000 cycles for GE0630DT4, GE0800DT4, GE1250DT4.

Certifications and compliance

Certifications obtained: EAC.
Compliant with standards: IEC/EN/BS 60947-1, IEC/EN/BS IEC/EN/BS 60947-3.

Summary table of combinations - switch disconnectors for photovoltaic applications

Four pole type ③	IEC conventional free air thermal current I _{th}	IEC rated operational current I _e DC21B ②			Direct operating handle			Door coupling handles			Shaft extensions for door coupling handles (the last 3 digits of GEX code indicate length in mm/in)		Auxiliary contacts 1NO/1NC	Terminal covers for:	
		600V	800V	1000V	Black	Black	Red/yellow	Exten. section	Max panel depth	Line	Load				
Order code	[A]	[A]	[A]	[A]	Order code	Order code	Order code	Order code	<input type="checkbox"/>	[mm/in]	Order code	Order code	Order code		

Switch disconnectors for photovoltaic applications.

GE0125DT4	125	125	125	100	GEX66ND	GEX66NB	GEX66N	GEX7227N	10mm/ 0.4"	267/10.51" 415/16.34" 576/22.68"	GEX1011	GEX8111	GEX8111
GE0250DT4	250	250	200										
GE0315DT4	315	315	280	250									
GE0630DT4	630	630	600	500	GEX67ND	GEX67NB	GEX67N	GEX7195N	14mm/ 0.6"	251/9.88" 401/15.79" 591/23.27"	GEX8121	GEX8121	
GE0800DT4	800	700	630	630									
GE1250DT4	1250	1250	1000	850	GEX68ND	GEX68NB	GEX68N	GEX7345N GEX7355N		267/10.51" 417/16.42" 607/23.90"	GEX8131	GEX8131	

③ The motorised control unit cannot be installed.

12 Switch disconnectors

Dimensions [mm(in)]

GA SERIES - 16A TO 160A SWITCH DISCONNECTORS

Direct operating version

GA016A...GA040A...
GA063SA...
GA040D

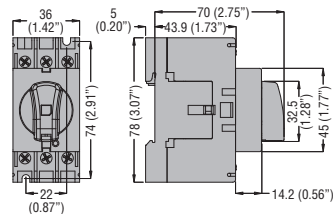

GA030A... - GA063A...GA160A...

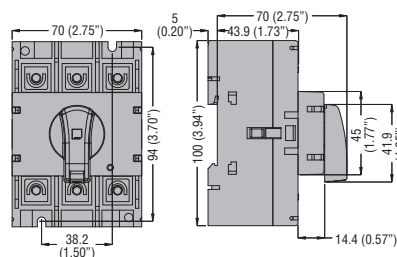

Door mount version

GA016C...GA040C
GA063SC

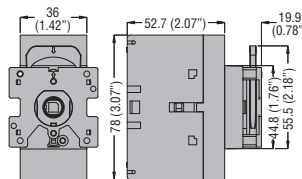

GA030C - GA063C...GA160C

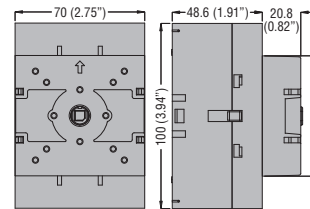

ADD-ON BLOCKS AND ACCESSORIES

For **GA016A...GA040A...**, **GA063SA...**, **GA040D**

Auxiliary contacts

GAX1011A
GAX1020A
GAX1110EA

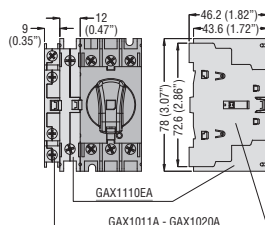

Fourth pole

GAX41040A - GAX42040A
GAX41063SA - GAX42063SA
GAX42040D

Neutral **GAX31A** - earth/ground **GAX33A** terminals

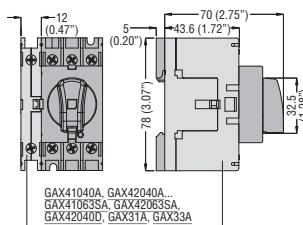

Mechanical interlock **GAX5000** and mechanical coupling system **GAX6000**

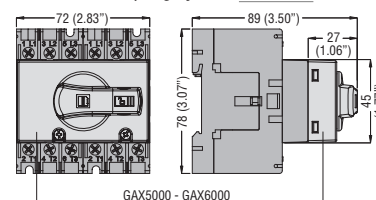

For **GA030A, GA063A...GA160A**

Auxiliary contacts

GAX1011A
GAX1020A
GAX1210EA

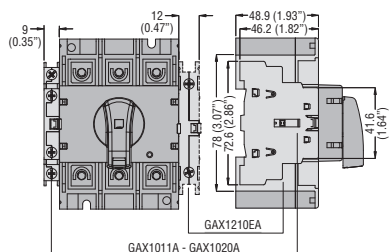

Fourth pole

GAX41125A
GAX42063A...GAX42160A

Neutral **GAX32A** - earth/ground **GAX34A** terminals

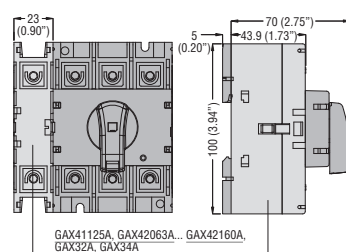

Mechanical interlock **GAX5001** and mechanical coupling system **GAX6001**

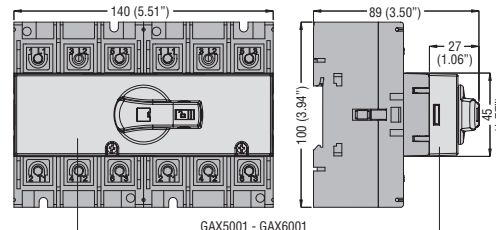

For **GA016C...GA040C** and **GA063SC**

Auxiliary contacts

GAX1011C

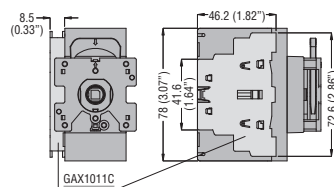

Fourth pole **GAX41040C - GAX42040C** and **GAX42063C**

Neutral **GAX31C** - earth/ground **GAX33C** terminals

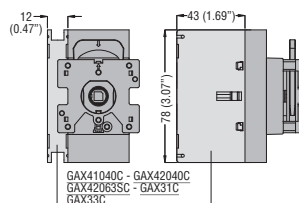

For **GA030C, GA063C...GA160C**

Auxiliary contacts

GAX1011C

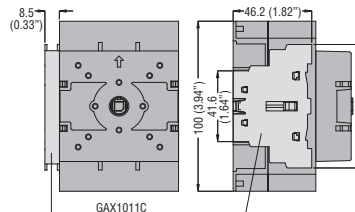

Fourth pole **GAX41125C - GAX42063C...GAX42160C**

Neutral **GAX32C** - earth/ground **GAX34C** terminals

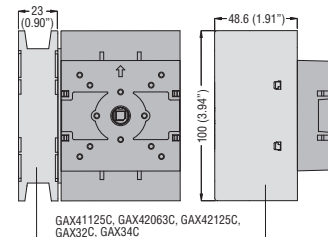

GD SERIES SWITCH DISCONNECTORS

Direct operating version

GD...AT2

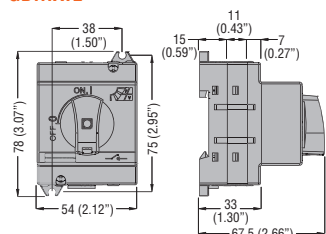

GD...AT3

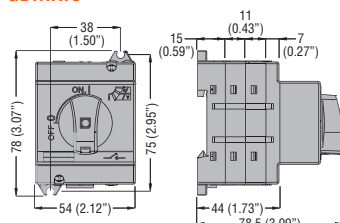

GD...AT4

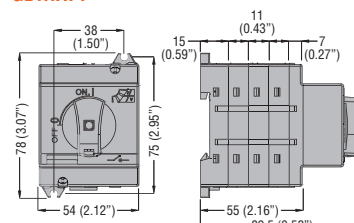

Handles

GAX61/61B

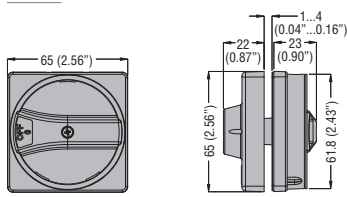

GAX62/62B

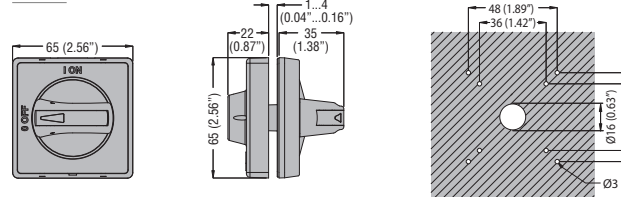

GAX63/63B/63K/63BK

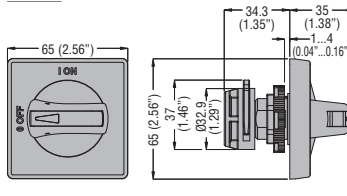

GAX631B

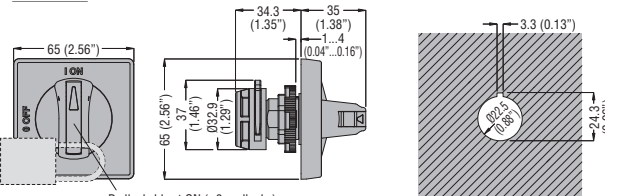

Padlockable at ON (≤3 padlocks)
per UNI 9490, UNI/EN 12845

GAX632/2B

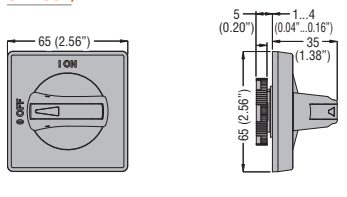

GAX64/64B

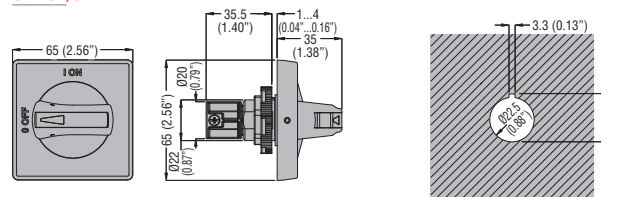

GAX66N/66NB

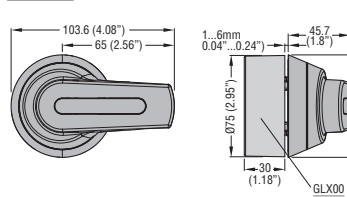

GAX67B

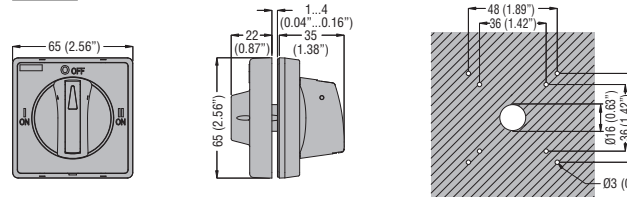

GAX68/68B

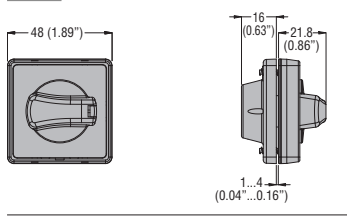

Shaft extensions for door coupling handles

GAX7...

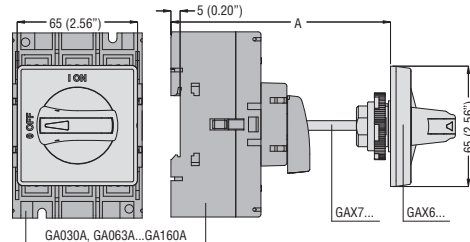
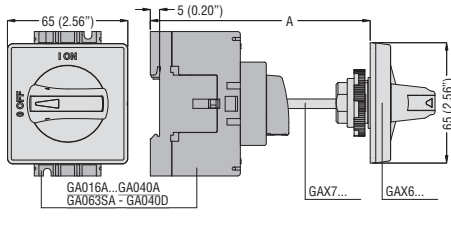

Extension	Length [mm (in)]	A [mm (in)] maximum					
		Type of handle					
		GAX61...	GAX62...	GAX63...	GAX64...	GAX67 B	GAX68...
GAX7055	55 (2.16)	99 (3.90)	97 (3.82)	102 (4.01)	116 (4.57)	97 (3.82)	98.5 (3.88)
GAX7070	70 (2.75)	114 (4.49)	112 (4.41)	117 (4.61)	131 (5.16)	112 (4.41)	113.5 (4.47)
GAX7090	90 (3.54)	134 (5.27)	132 (5.20)	137 (5.39)	151 (5.94)	132 (5.20)	133.5 (5.25)
GAX7150	150 (5.90)	194 (7.64)	192 (7.56)	197 (7.75)	211 (8.31)	192 (7.56)	193.5 (7.62)
GAX7200	200 (7.87)	244 (9.61)	242 (9.53)	247 (9.72)	261 (10.27)	242 (9.53)	243.5 (9.59)
GAX7300	300 (11.81)	344 (13.54)	342 (13.46)	347 (13.66)	361 (14.21)	342 (13.46)	343.5 (13.52)
GAX7400	400 (15.75)	444 (17.48)	442 (17.40)	447 (17.60)	461 (18.15)	442 (17.40)	443.5 (17.46)
GAX7500	500 (19.68)	544 (21.42)	542 (21.34)	547 (21.53)	561 (22.09)	542 (21.34)	543.5 (21.40)

GAX7... used with GAX5000, GAX5001 and GAX6000

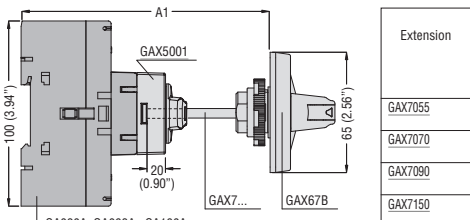
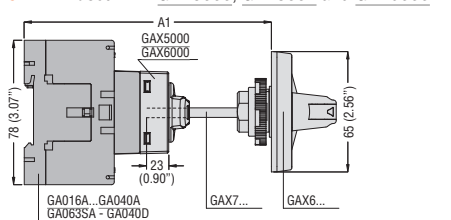

Extension	Length [mm (in)]	A1 [mm (in)] maximum					
		Used with GAX6000		Used with GAX5000/GAX5001			
		Type of handle					
		GAX61...	GAX62...	GAX63...	GAX64...	GAX67B	
GAX7055	55 (2.16)	116 (4.57)	114 (4.49)	119 (4.68)	133 (5.24)	115.5 (4.55)	114 (4.49)
GAX7070	70 (2.75)	131 (5.16)	129 (5.08)	134 (5.27)	148 (5.83)	130.5 (5.14)	129 (5.08)
GAX7090	90 (3.54)	151 (5.94)	149 (5.87)	154 (6.06)	168 (6.61)	150.5 (5.92)	149 (5.87)
GAX7150	150 (5.90)	211 (8.31)	209 (8.23)	214 (8.42)	228 (8.98)	210.5 (8.29)	209 (8.23)
GAX7200	200 (7.87)	261 (10.27)	259 (10.20)	264 (10.39)	278 (10.94)	260.5 (10.25)	259 (10.20)
GAX7300	300 (11.81)	361 (14.21)	359 (14.13)	364 (14.33)	378 (14.88)	360.5 (14.20)	359 (14.13)
GAX7400	400 (15.75)	461 (18.15)	459 (18.07)	464 (18.27)	468 (18.42)	460.5 (18.13)	459 (18.07)
GAX7500	500 (19.68)	561 (22.09)	559 (22.01)	564 (22.20)	578 (22.75)	560.5 (22.07)	559 (22.01)

GAX7...AN used with GAX60B and GAX66N/66NB

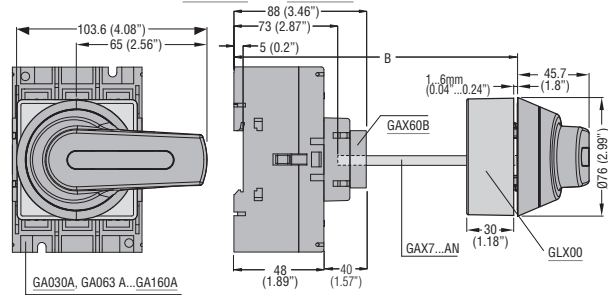

GAX7...AN used with GAX6001 and GAX66N/66NB

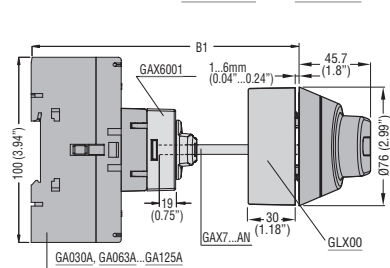

Extension	Length	B		B1
		with GAX66N/66NB handle		
	[mm(in)]	[mm(in)]	[mm(in)]	[mm(in)]
GAX7150AN	178 (7.00)	120...226 (4.72"...9.00")	120...223 (4.72"...8.80")	
GAX7200AN	228 (8.98)	120...276 (4.72"...10.87")	120...273 (4.72"...10.75")	
GAX7300AN	328 (12.91)	120...376 (4.72"...14.80")	120...373 (4.72"...14.68")	
GAX7400AN	428 (16.85)	120...476 (4.72"...18.74")	120...473 (4.72"...18.62")	
GAX7500AN	528 (20.79)	120...576 (4.72"...22.68")	120...573 (4.72"...22.56")	

Terminal covers

GAX81 - GAX83

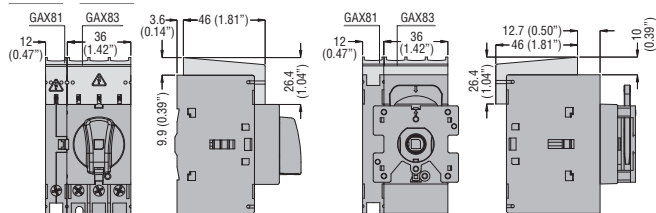

GAX82 - GAX84

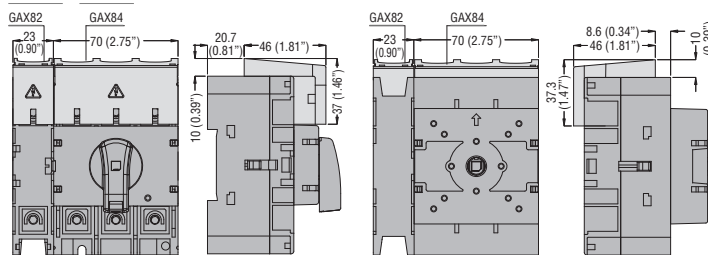

Fuse holder

GAX391 - GAX391UL

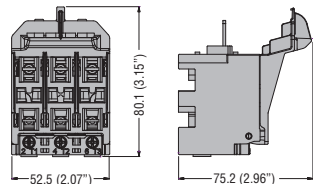

ENCLOSED SWITCH DISCONNECTORS AND EMPTY ENCLOSURES

**GAZ016...GAZ040...
GAZ016...GAZ040...UL
GAZ1... - GAZ1...UL
GAZ025D...**

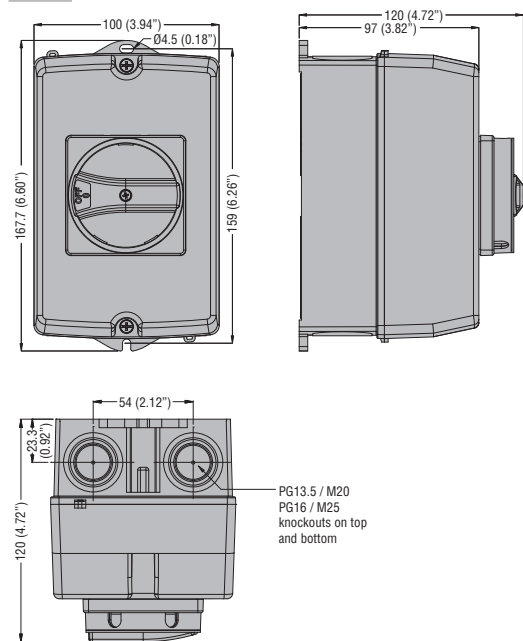

**GAZ063SA...GAZ100C...
GAZ063SAUL...
GAZ2... - GAZ2...UL**

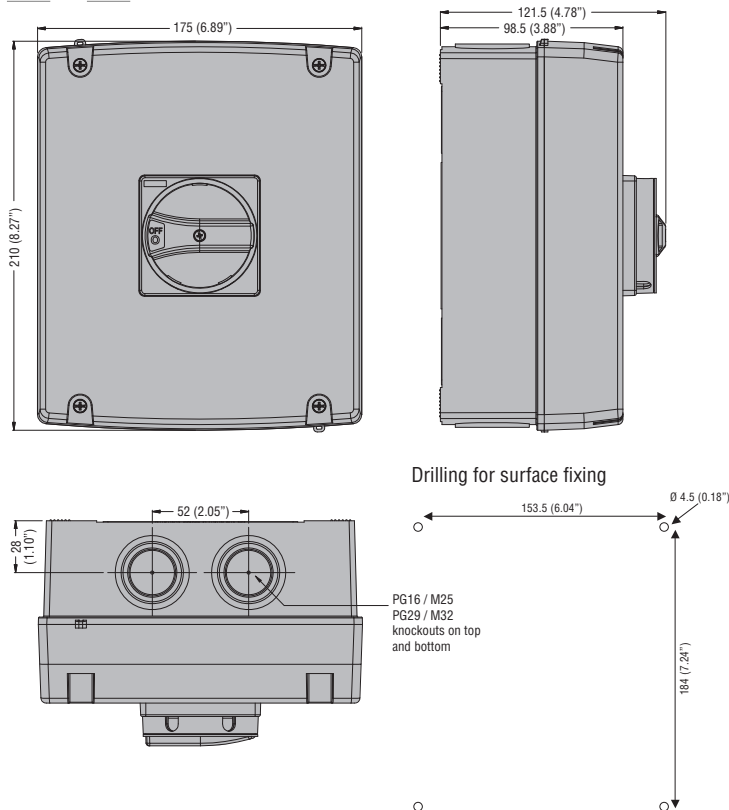

12 Switch disconnectors

Dimensions [mm(in)]

GAZ025ET6...GAZ063SAET6 - GAZ025ET8...GAZ063SAET8 - GAZ032D... - GAZ040D...

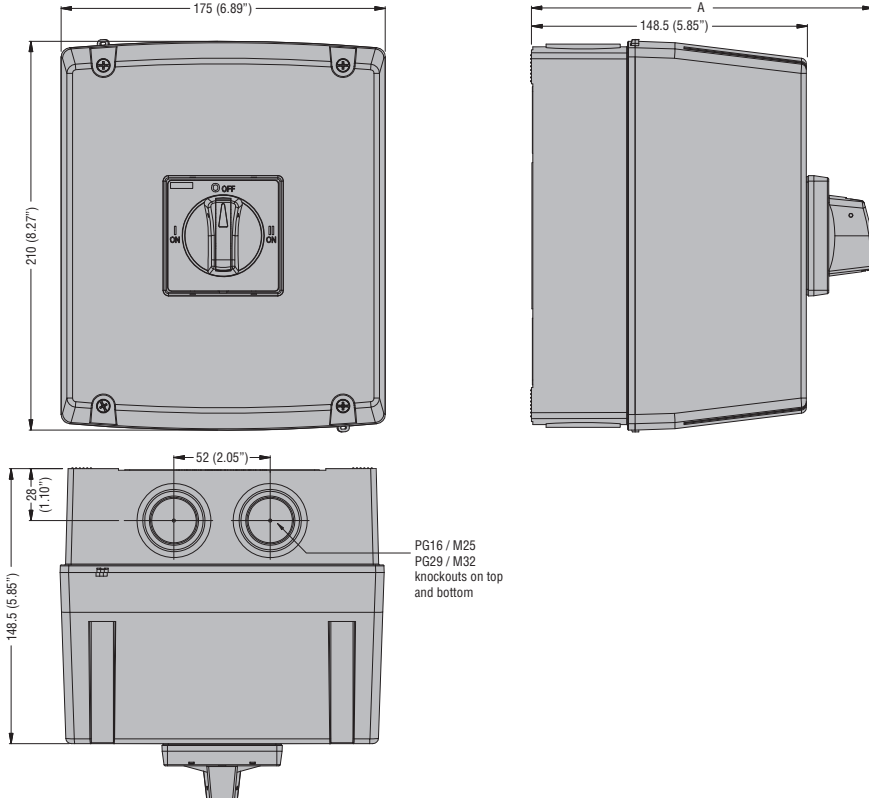

Drilling

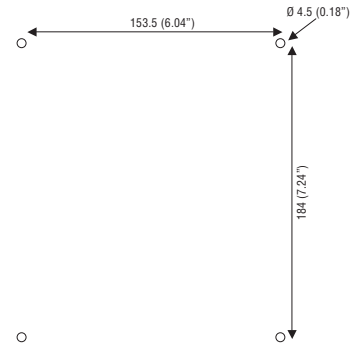

Type	A
GAZ032D...	171.5 (6.75")
GAZ040D...	171.5 (6.75")
GAZ025ET...	183.5 (7.22")
GAZ063SAET...	183.5 (7.22")

GAZ125... - GAZ063...UL - GAZ125...UL - GAZ080ET6 - GAZ125ET6 - GAZ160ET6 - GAZ080ET8 - GAZ125ET8 - GAZ160ET8

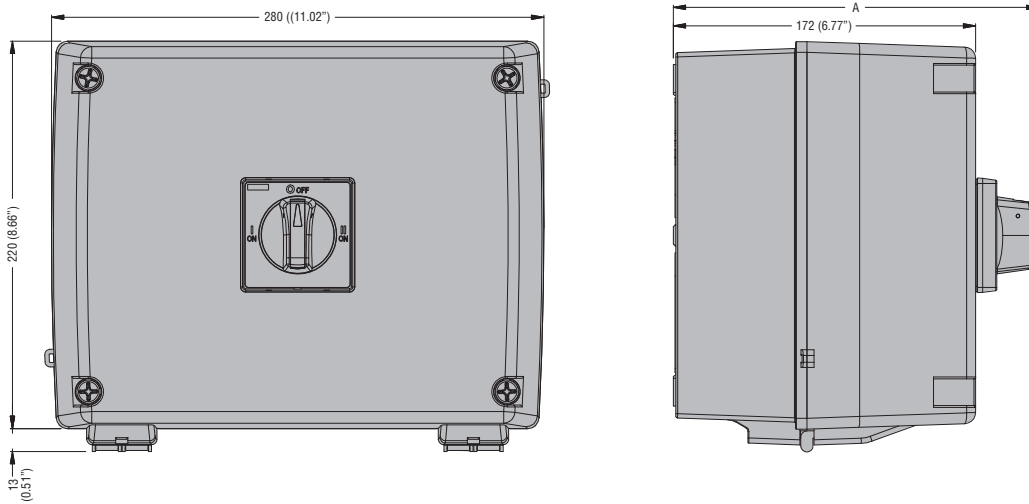

Type	A
GAZ125	193 (7.60")
GAZ063...UL	193 (7.60")
GAZ125...UL	193 (7.60")
GAZ080ET6	208 (8.19")
GAZ125ET6	208 (8.19")
GAZ160ET6	208 (8.19")
GAZ080ET8	208 (8.19")
GAZ125ET8	208 (8.19")
GAZ160ET8	208 (8.19")

GAZ125... - GAZ160... - GAZ080UL...GAZ125...UL - GAZ3...

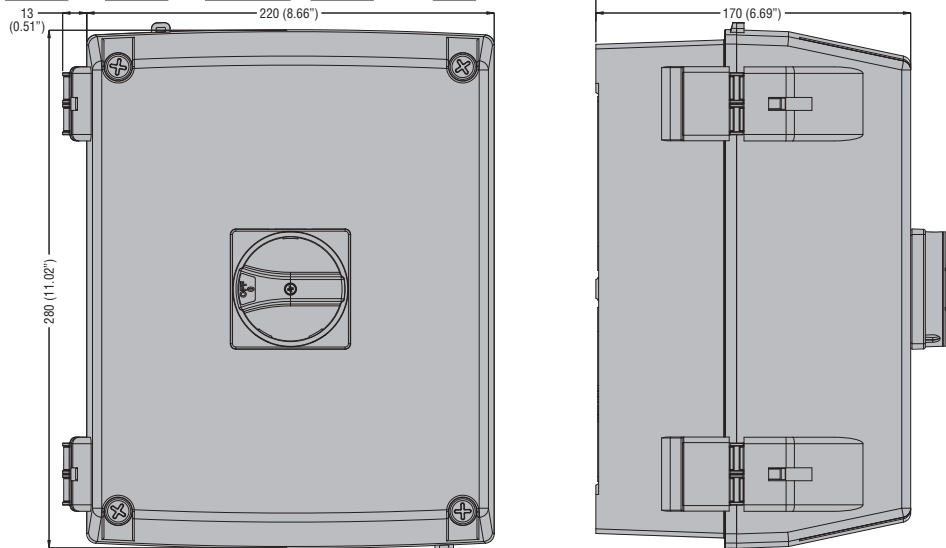

SWITCH DISCONNECTORS AND CHANGEOVER SWITCHES IN METAL AND STAINLESS STEEL AISI 304 ENCLOSURES

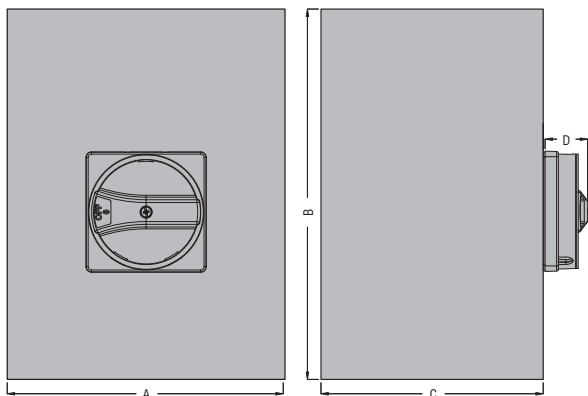

Type	A	B	C	D
GAZM016...GAZM100...	150 (5.90")	200 (7.87")	120 (4.72")	23 (0.90")
GAZM125...GAZM160...	200 (7.87")	300 (11.81")	120 (4.72")	23 (0.90")
GAZM016E...GAZM063SAE...	150 (5.90")	200 (7.87")	120 (4.72")	35 (1.38")
GAZM063ET6...GAZM160ET6...	200 (7.87")	300 (11.81")	120 (4.72")	35 (1.38")
GAZM063ET8...GAZM160ET8...	300 (11.81")	400 (15.75")	120 (4.72")	35 (1.38")
GAZS016...GAZS100...	150 (5.90")	200 (7.87")	120 (4.72")	23 (0.90")
GLZM0160...GLZM0315...	300 (11.81")	400 (15.75")	250 (9.84")	45.7 (1.80")
GLZM0160E...GLZM0315E...	300 (11.81")	400 (15.75")	250 (9.84")	45.7 (1.80")

EMPTY METAL ENCLOSURES

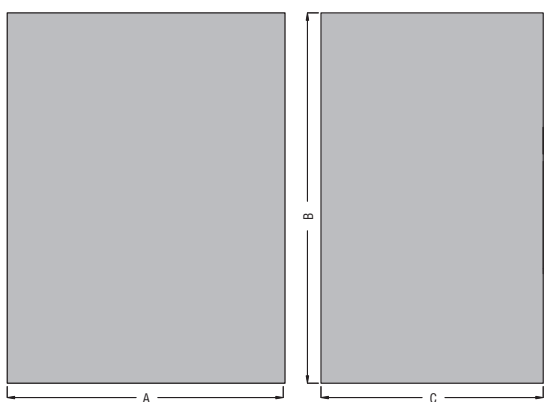

Type	A	B	C
GAZM1	150 (5.90")	200 (7.87")	120 (4.72")
GAZM2	200 (7.87")	300 (11.81")	120 (4.72")
GAZM3	300 (11.81")	400 (15.75")	120 (4.72")
GAZS1	150 (5.90")	200 (7.87")	120 (4.72")
GLZM1	300 (11.81")	400 (15.75")	250 (9.84")

GL SERIES 100A TO 630A SWITCH DISCONNECTORS

GL0160C1...GL0315C1

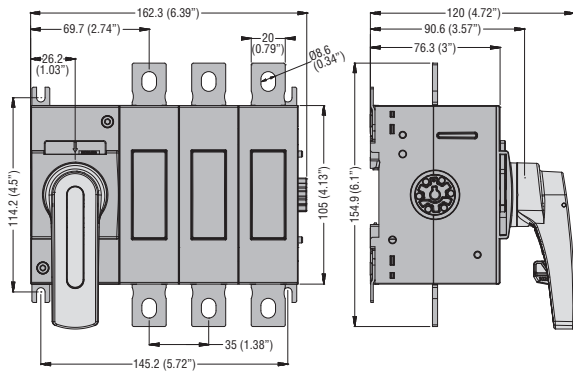

GL0160C1...GL0315C1 with add-on fourth pole GLX420315

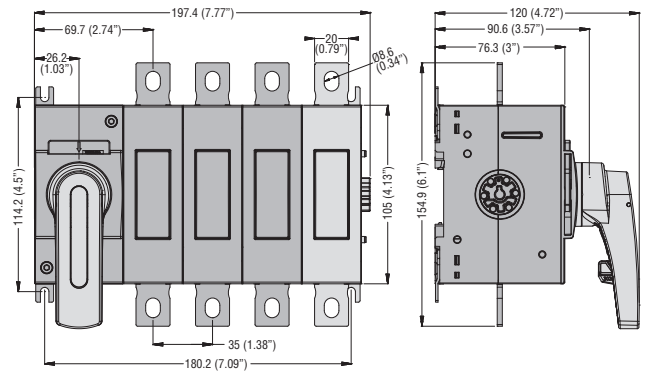

GL0100C1UL - GL0200C1UL

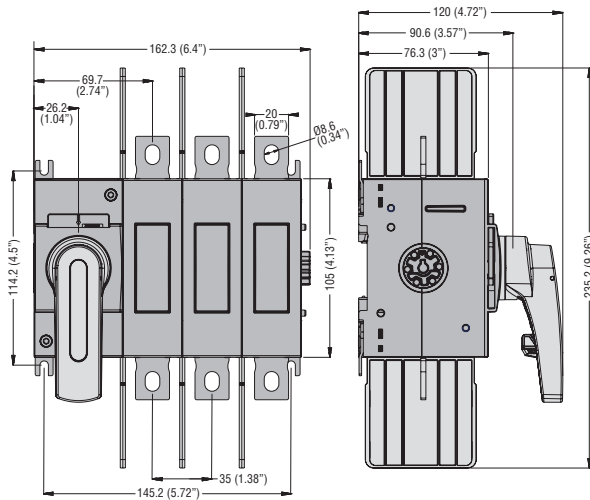

GL0100C1UL - GL0200C1UL with add-on fourth pole GLX420100UL - GLX420200UL

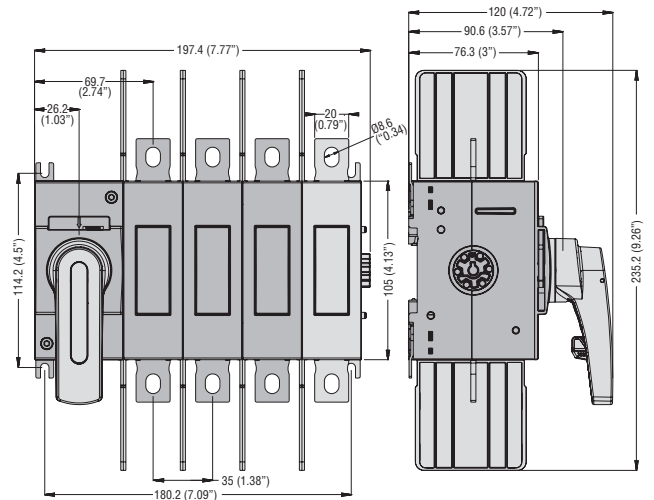

GL0320C1...GL0500C1

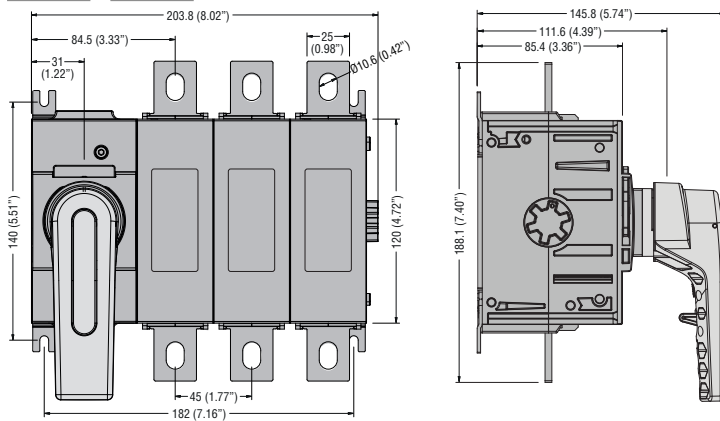

GL0320C1...GL0500C1 with add-on fourth pole GLX420320...0500

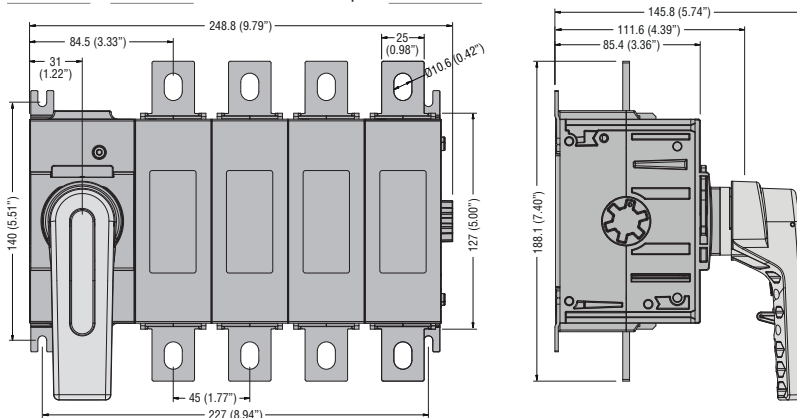

GL0630C1 - GL0400C1UL

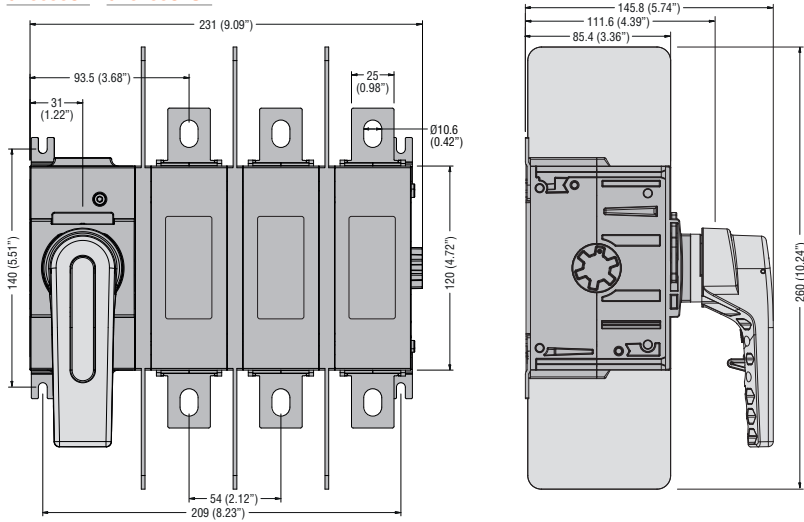

GL0630C1 - GL0400C1UL with add-on fourth pole GLX420630 - GLX420400UL

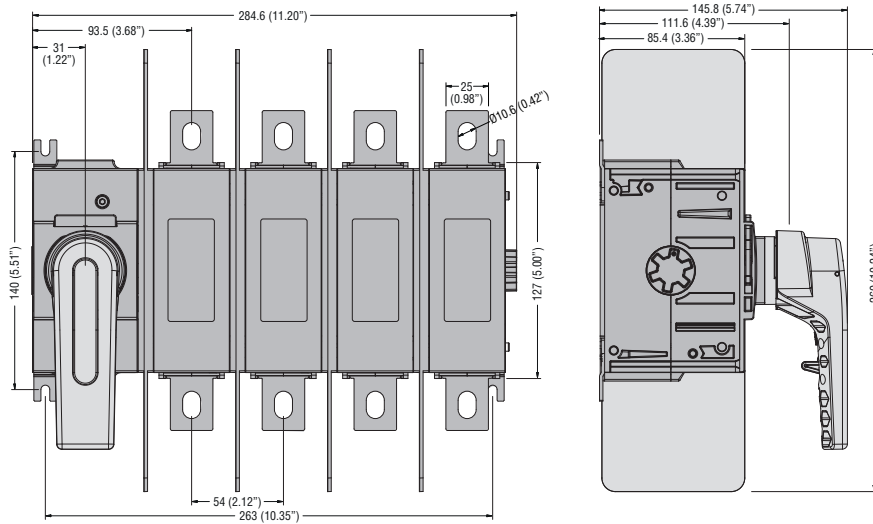

GLC0160C1...GLC0315C1

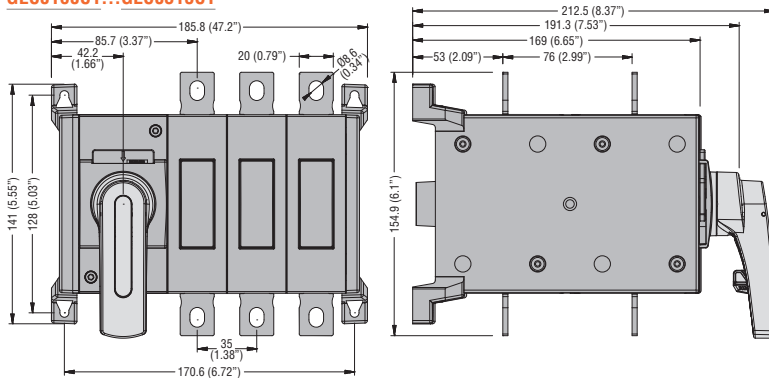

GLC0160T4C1...GLC0315T4C1

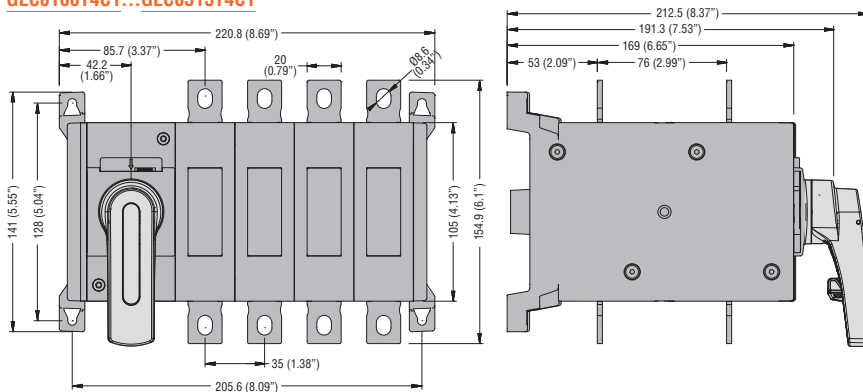

GLC0100C1UL - GLC0200C1UL

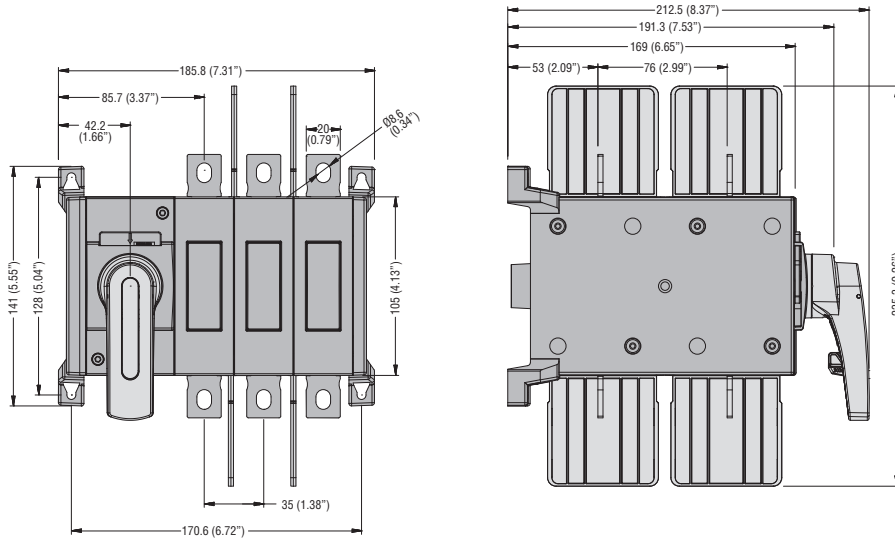

GLC0100T4C1UL - GLC0200T4C1UL

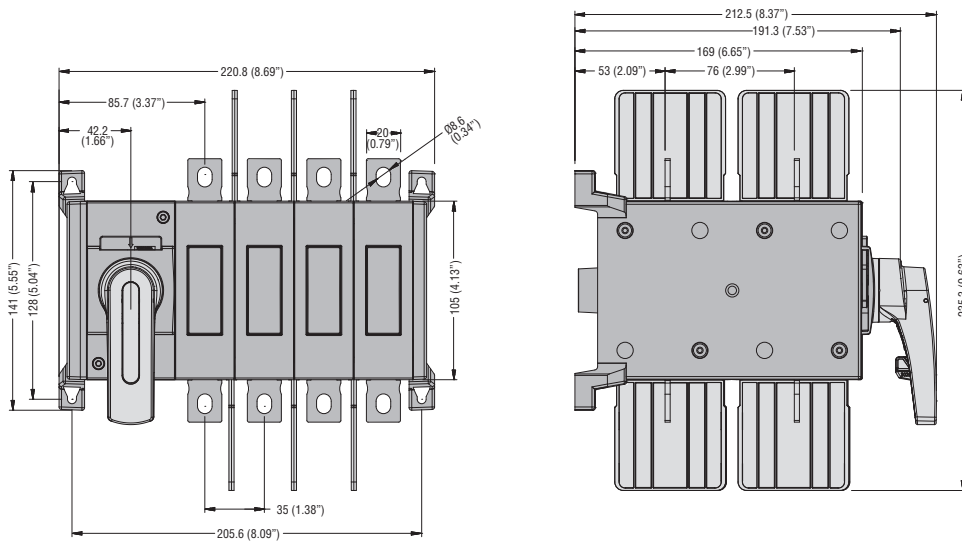

GLC0320C1...GLC0500C1

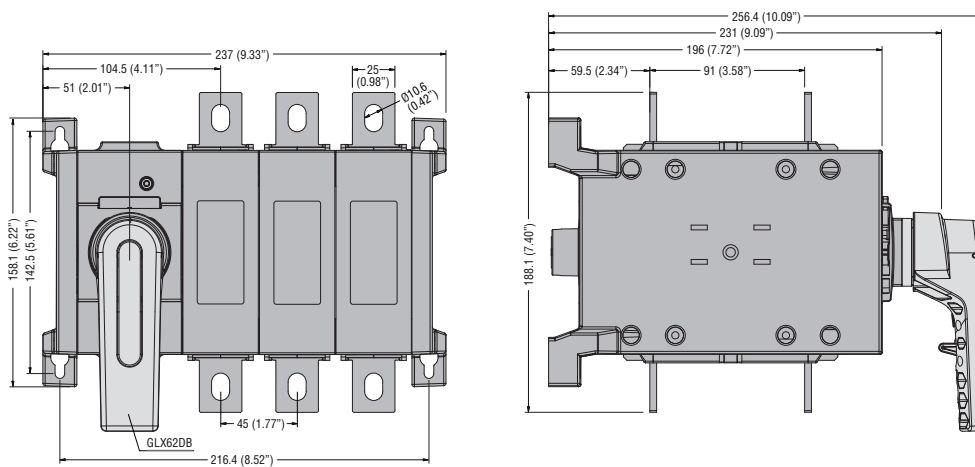

12 Switch disconnectors

Dimensions [mm(in)]

GLC0320T4C1...GLC0500T4C1

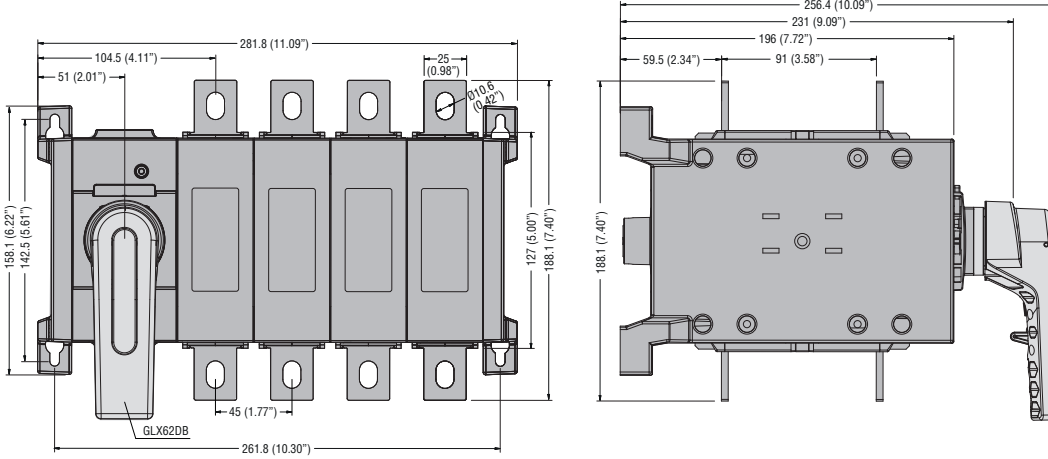

GLC0630C1 - GLC0400C1UL

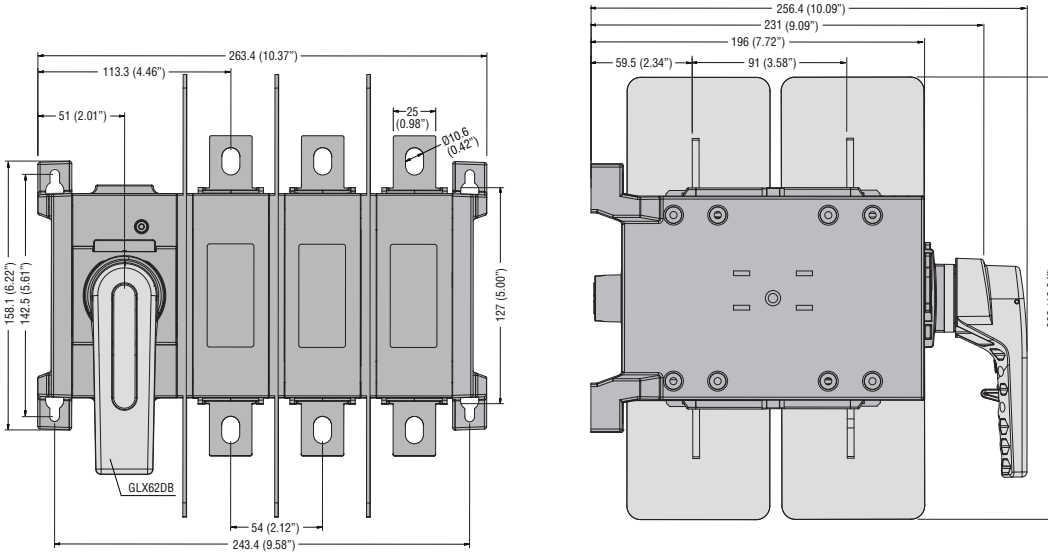

GLC0630T4C1 - GLC0400T4C1UL

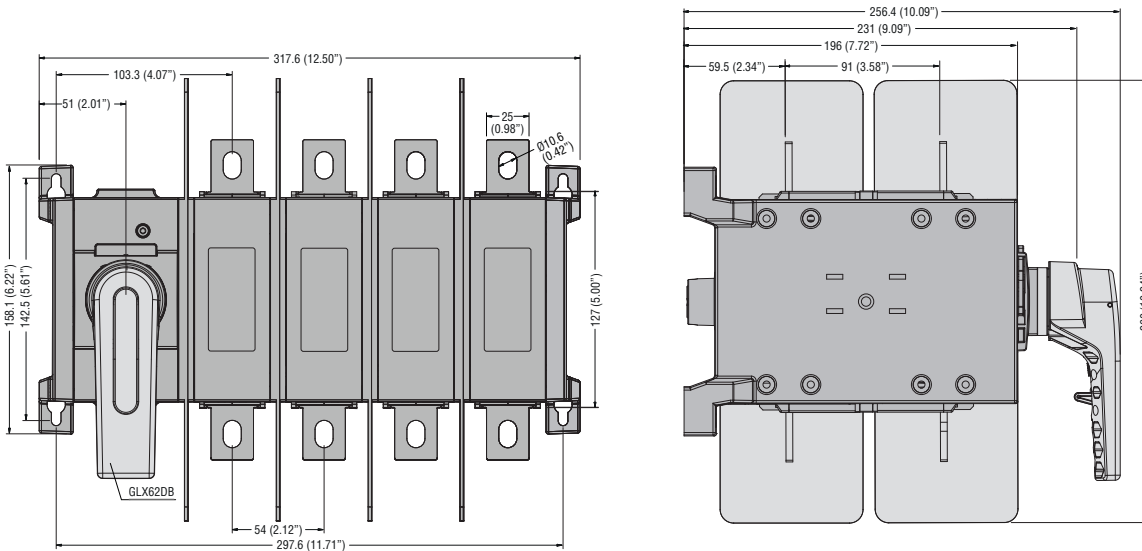

12 Switch disconnectors

Dimensions [mm(in)]

GLX800 - GLX801 terminal covers
GLX900 - GLX901 one-pole phase barrier
GLX10... auxiliary contacts

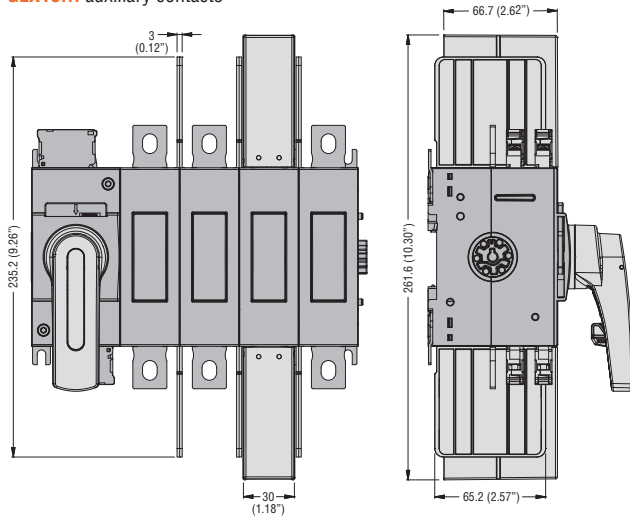

GLX61 - GLX61B - GLX61CB handles

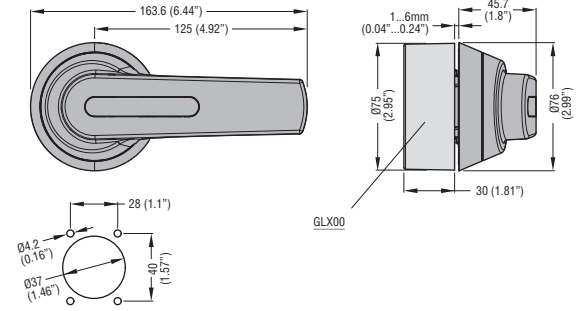

GLX62 - GLX62B - GLX62CB handles

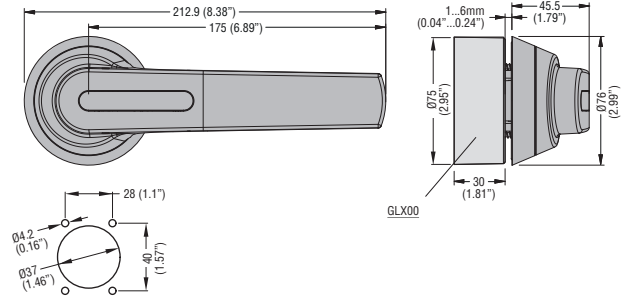

GLX802 - GLX803 terminal covers
GLX902 - GLX903 one-pole phase barrier
GLX10... auxiliary contacts

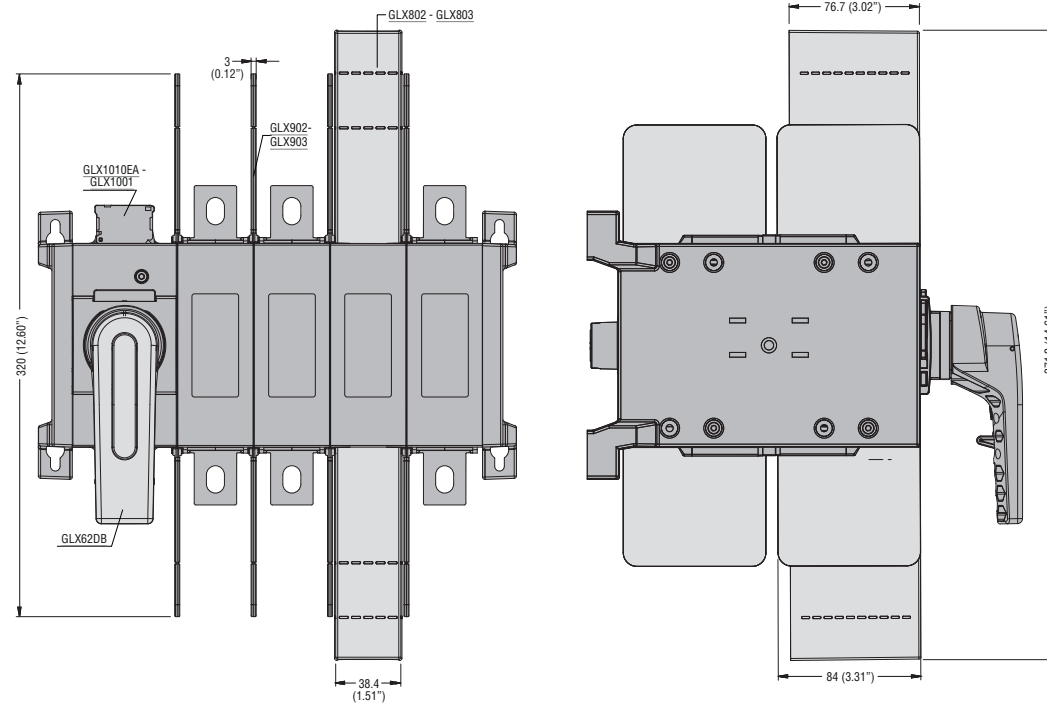

12 Switch disconnectors

Dimensions [mm(in)]

GLX7... shaft extensions for door coupling handles
GLX00 shaft alignment ring

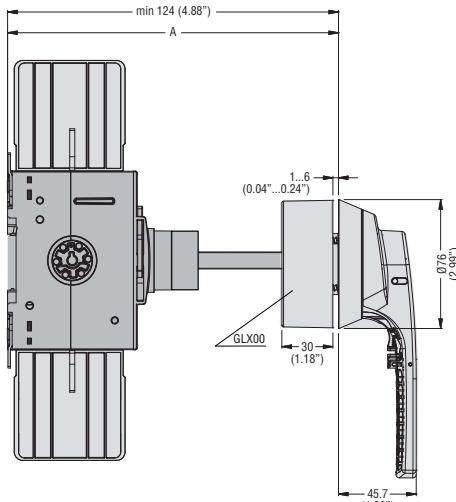
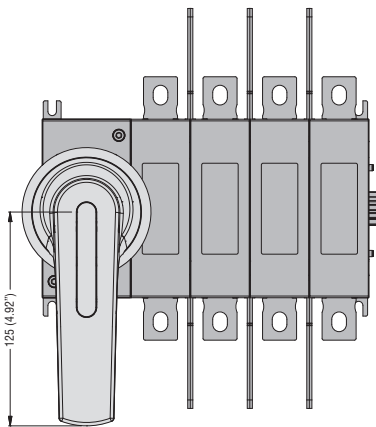

GLX7...S10	A mm (in)	
	min	max
GLX7150S10	124...194	(4.88...7.64')
GLX7200S10	124...244	(4.88...9.61')
GLX7300S10	124...344	(4.88...13.54')
GLX7400S10	124...444	(4.88...17.48')
GLX7500S10	124...544	(4.88...21.42')

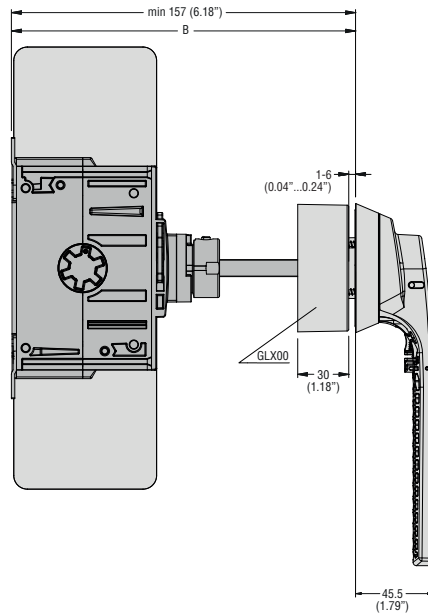
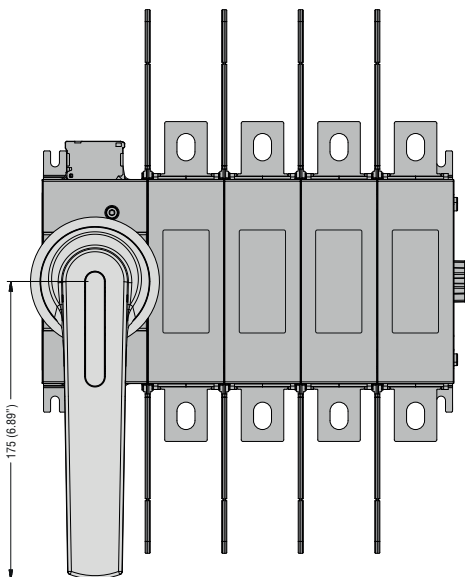

GLX7...S10	B mm (in)	
	min	max
GLX7150S10	157...227	(6.18...8.94')
GLX7200S10	157...277	(6.18...10.90')
GLX7300S10	157...377	(6.18...14.84')
GLX7400S10	157...477	(6.18...18.78')
GLX7500S10	157...577	(6.18...22.72')

12 Switch disconnectors

Dimensions [mm(in)]

GM SERIES 30A TO 800A SWITCH DISCONNECTORS

GMF...030C12

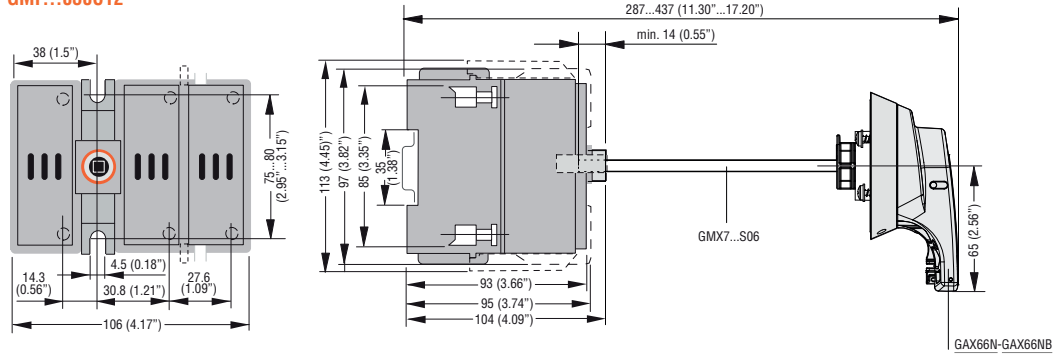

GMFJ060C12

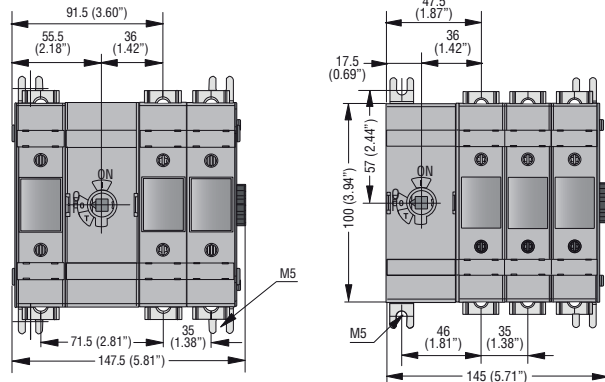

GMFJ060C03

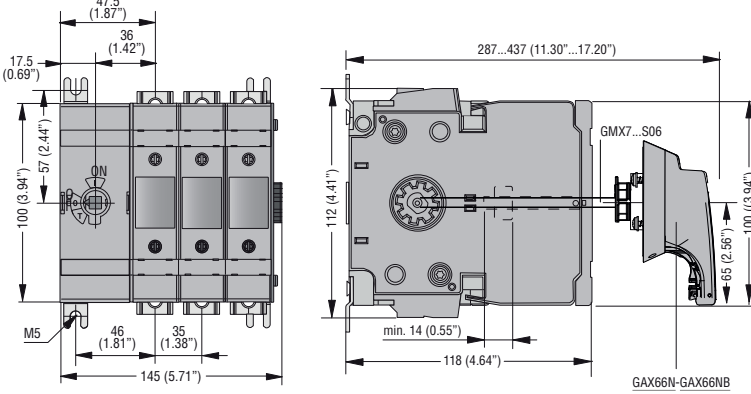

GMFJ100C03

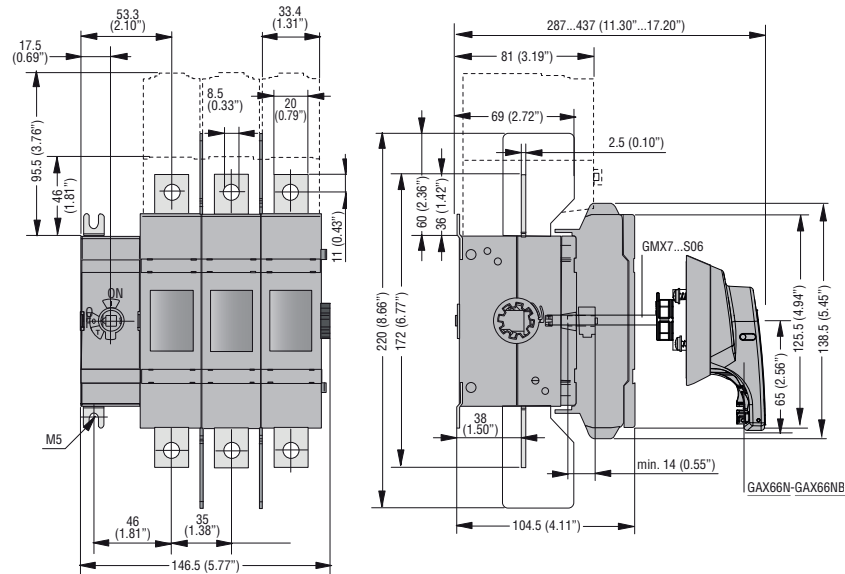

GMFJ200C03

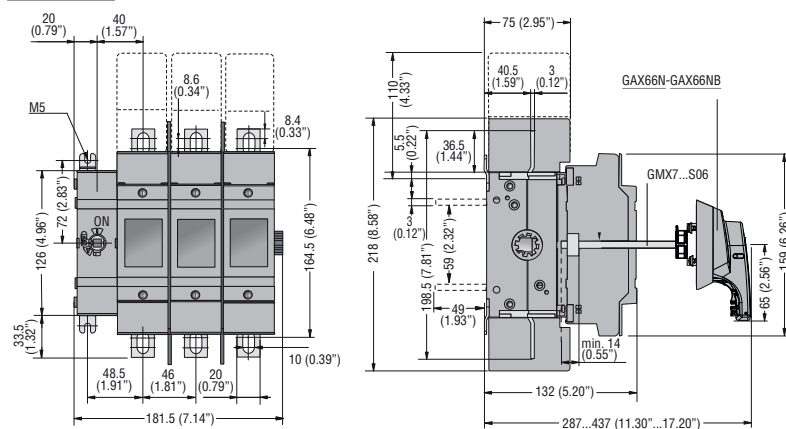

GMFJ400C03

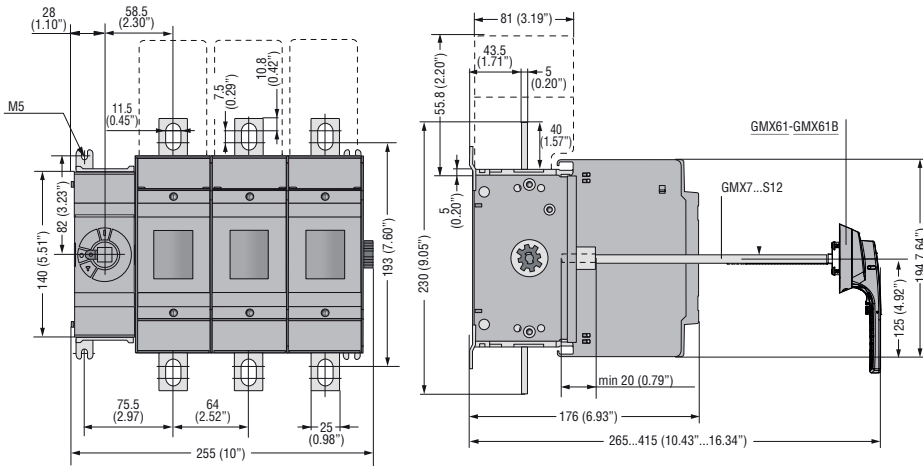

GMFJ600C03 - GMFL800C03

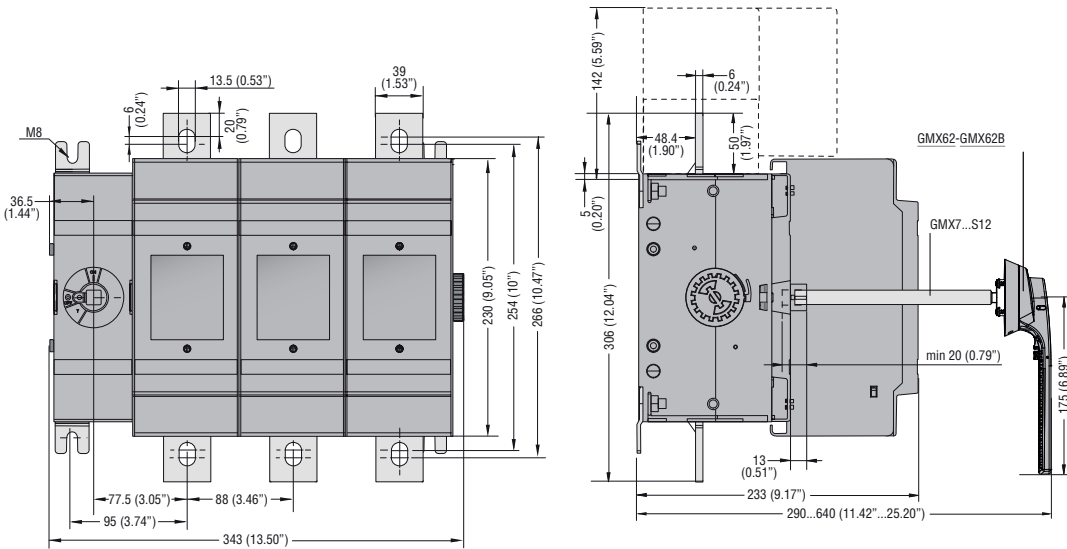

OPEN AND ENCLOSED GA SERIES 16A TO 160A SWITCH DISCONNECTORS

Three-pole disconnectors
GA016...GA160A.../C
GAZ016...GAZ160/B
GAZ016UL...GAZ125UL
GAZM016...GAZM160/B
GAZS016...GAZS100/B

Fourth pole
GAX42... **GAX41...**

Four-pole disconnectors
GAZ016T4...GAZ160T4/B
GAZ016T4UL...GAZ125T4UL
GAZM016T4...GAZM160T4/B

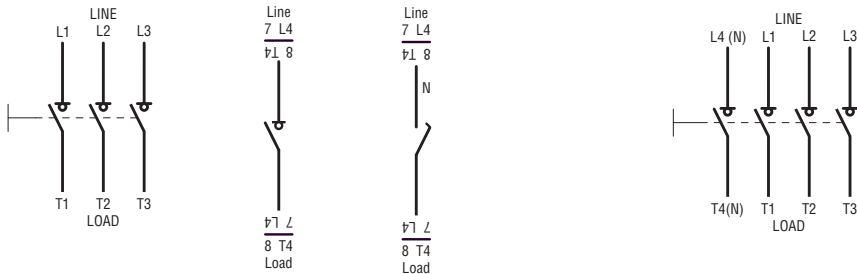

ADD-ON BLOCKS AND ACCESSORIES

Auxiliary contacts
GAX1011... **GAX1020A**

GAX11... - GAX12...

Neutral terminal
GAX31... - GAX32...

Earth/Ground terminal
GAX33... - GAX34...

Fuse holder
GAX391 - GAX391UL

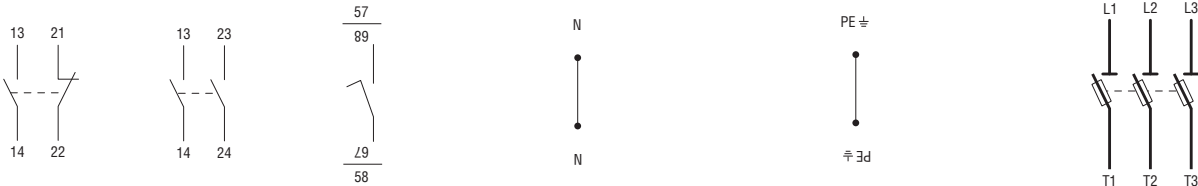

ENCLOSED AND ASSEMBLED CHANGEOVER SWITCHES

Three-pole **GA...ET6**

Four-pole **GA...ET8**

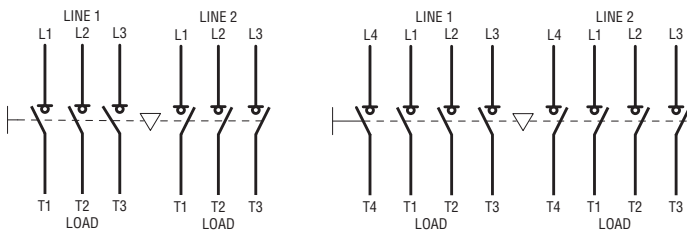

OPEN AND ENCLOSED GL SERIES 100 TO 630A SWITCH DISCONNECTORS

Three-pole
GL0160...GL0630...
GLZM0160...GLZM0315/B

Fourth pole
GLX42...

Four-pole
GLZM0160T4...GLZM0315T4/B

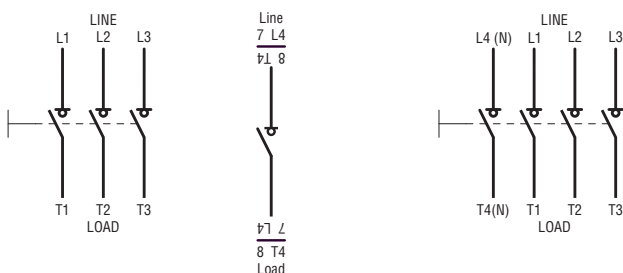

ADD-ON BLOCKS AND ACCESSORIES

Auxiliary contacts
GLX1010EA



GLX1001

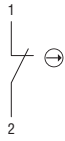

Neutral terminal
GLX300 - GLX302



Earth/Ground terminal
GLX301 - GLX303



OPEN AND ENCLOSED GL SERIES 100 TO 630A CHANGEOVER SWITCHES

Three-pole
GLC...C1
GLZM...ET6

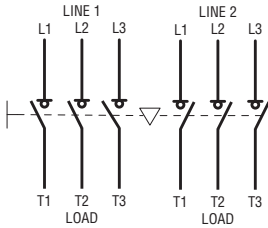

Four-pole
GLC...T4C1
GLZM...ET8

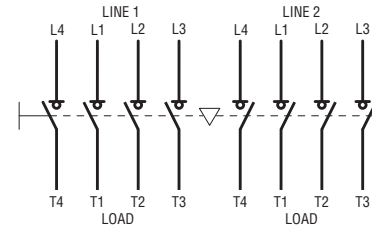

GE SERIES 50A TO 1600A SWITCH DISCONNECTORS

Three-pole
GE0160 - GE1600
GE0160P

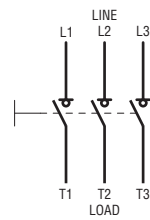

Three-pole with fuse holder
GE0050F - GE0125F
GE0160N - GE0800N
GE0160B - GE0800B

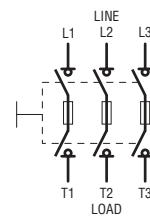

Four-pole
GE0160T4 - GE1600T4
GE0160T4P

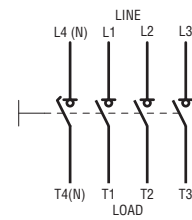

Four-pole with fuse holder
GE0050FT4 - GE0125FT4
GE0160NT4 - GE0800NT4
GE0160BT4 - GE0800BT4

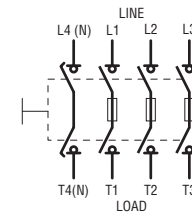

GE SERIES 160 TO 1600A CHANGEOVER SWITCHES

Three-pole
GE0160E - GE0200E - GE1600...3150E

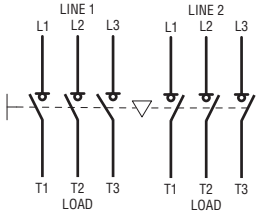

GE0201E...GE1250E

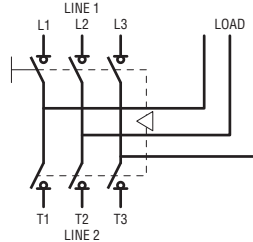

Four-pole
GE0160ET4 - GE0200ET4 - GE1600...3150ET4

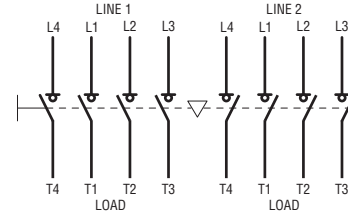

GE0201ET4...GE1250ET4

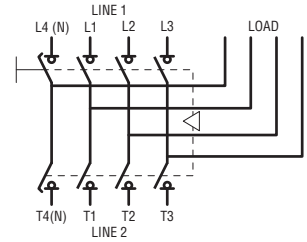

ADD-ON BLOCKS AND ACCESSORIES

Auxiliary contacts
GEX1011...



GEX1022...

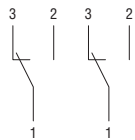

Motorised control unit
GEX690C - GEX691C - GEX692C

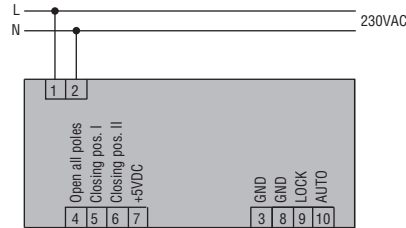

Motorised control unit
GEX693C - GEX694C

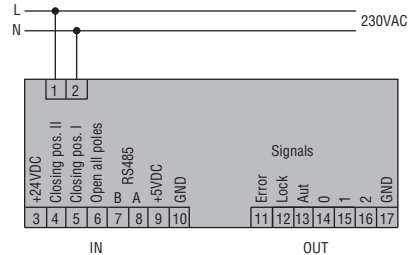

GM SERIES 30A TO 800A SWITCH DISCONNECTORS

GM...030...GM...800

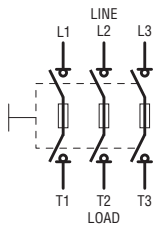

Auxiliary contacts GMX1010



GMX1001

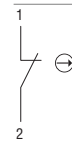

GMX1011

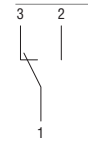

SWITCH DISCONNECTORS FOR PHOTOVOLTAIC APPLICATIONS GA...D (poles in series to wire)

One-line control 2 poles in series

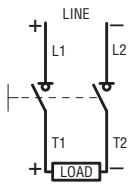

3 poles in series

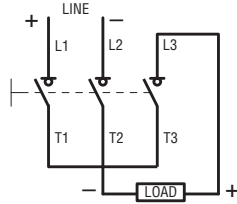

4 poles in series

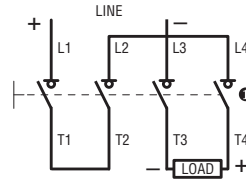

Two-lines control 2+2 poles in series

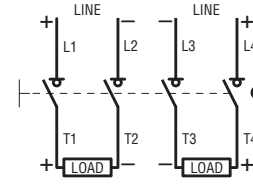

❶ The positive pole fitted on the right side of the disconnector can also be fitted on the left side; the connections must be changed in consequence.

SWITCH DISCONNECTORS FOR PHOTOVOLTAIC APPLICATIONS GD... (jumpers supplied as standard)

One-line control GD...AT2

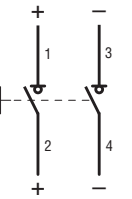

GD...AT3

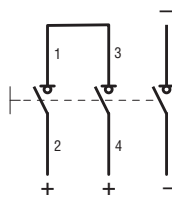

GD...AT4

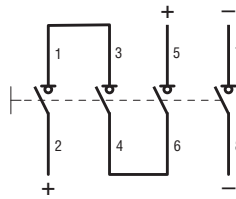

SWITCH DISCONNECTORS FOR PHOTOVOLTAIC APPLICATIONS GE...DT4 (poles in series to wire)

One-line control 4 poles in series

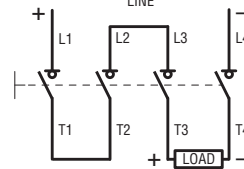

4 (2+2) poles in series

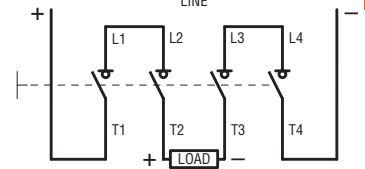

12 Switch disconnectors

Technical characteristics

GA series 16A to 160A - Switch disconnectors



INDEX

TECHNICAL DATA ACCORDING TO IEC/EN/BS 60947 RATINGS

TYPE	3-pole	GA016...	GA025...	GA032...	GA040...	GA063S...	GA030...	GA063...	GA080...	GA100...	GA125...	GA160...
	4-pole	GAX4...040...				GAX4...063S...	GAX4...063...		GAX4...080...	GAX4...100...	GAX4...125...	GAX4...160...

CONTACT CHARACTERISTICS

IEC conventional free air thermal current I _{th} (≤40°C)	A	16	25	32	40	63	30	63	80	100	125	160	
IEC rated insulation voltage U _i	V	1000											
IEC rated impulse withstand voltage U _{imp}	kV	8											
IEC rated operational current I _e													
AC21A	400V	A	16	25	32	40	63	30	63	80	100	125	160
	500V	A	16	25	32	40	63	30	63	80	100	125	160
	690V	A	16	25	32	40	63	30	63	80	100	125	160
AC22A	400V	A	16	25	32	40	45	30	63	80	100	125	125
	500V	A	16	25	32	40	45	30	63	80	100	125	125
	690V	A	16	25	32	40	45	30	63	80	100	125	125
AC23A	400V	A	16	25	32	40	45	30	63	80	100	125	125
	500V	A	16	25	25	25	25	30	63	63	80	100	100
	690V	A	16	25	25	25	25	30	63	47	47	47	47
Power dissipation	W/pole	0.2	0.4	0.6	1	2.9	0.4	1.6	2.6	4	6.3	12	
IEC rated operational power AC23A													
400V	kW	7.5	11	15	18.5	22	15	30	45	55	55	55	
	kW	11	22	22	22	22	30	45	45	45	45	45	
IEC reactive power for control of capacitors 400V	kvar	7.5	10	12.5	15	15	12.5	25	30	40	50	50	

SHORT CIRCUIT PROTECTION

Conditional short-circuit current ^①	kA rms	10					50					
With fuse class gG	A	16	25	32	40	63	63	63	80	100	125	160
Making capacity AC23A 400V	A	160	250	320	400	450	300	630	800	1000	1250	1250
Breaking capacity AC23A 400V	A	128	200	256	320	360	240	504	640	800	1000	1000
Mechanical life	cycles	100,000					30,000					
Electrical life (AC21A)	cycles	100,000				15,000	30,000					1,500
Terminals	mm	Pillar terminal 5.6 x 6.5 - M4 Phillips 2					Pillar terminal 12.4 x 10.4 - M8 Metric Allen key 4					
Tightening torque	Nm	1.8...2					5...6					
	lb.in	16...18					45...54					
Conductor section min...max	mm ²	0.75...16					4...70					
	AWG	18...6					12...1					

AMBIENT CONDITIONS

Temperature	Operating	°C	-25...+55									
	Storage	°C	-40...+70									
Maximum altitude	m	3000										
Mounting position	Normal	Vertical										
	Admissible	Any										
Fixing	Screw or 35mm DIN rail (IEC/EN 60715)											

① For more details contact our Technical support; see contact details on inside front cover.

TECHNICAL DATA ACCORDING TO UL/CSA RATINGS

TYPE		GA016...	GA025...	GA032...	GA040...	GA063S...	GA030...	GA063...	GA080...	GA100...	GA125...	—	
Compliance		UL60947-4-1; CSA C22.2 n°60947-4-1					UL98; CSA C22.2 n°4					—	
General purpose current ratings	A	16	25	32	40	60	30	60	100	100	100	—	
Max operating voltage	V	600											
Horsepower ratings/motor FLA current three-phase	240V	HP/A	5/15.2	7.5/22	10/28	15/42	15/42	10/28	20/54	25/68	30/80	30/80	—
	480V	HP/A	10/14	15/21	20/27	20/27	30/40	20/27	40/52	40/52	50/65	60/77	—
	600V	HP/A	10/11	20/22	20/22	25/27	32/32	30/32	40/41	40/41	50/52	60/62	—
Short circuit ratings	KA rms	5					100 ^②						—
With fuse	class/A	RK5/30	RK5/30	RK5/35	RK5/45	RK5/45	J/60	J/60	J/100	J/100	J/100	—	
Minimum enclosure dimensions at rated current	mm (in)	—					150 x 140 x 110 (5.90 x 5.51 x 4.33")						—

② Up to 480V with protection fuses type CC, J, or T (200A max).

12 Switch disconnectors

Technical characteristics
GL series 100A to 630A - Switch disconnectors

TECHNICAL DATA ACCORDING TO IEC/EN/BS 60947

TYPE	3-pole	GL0160...	GL0200...	GL0250...	GL0315...	GL0320...	GL0400...	GL0500...	GL0630...
	4-pole	GLX420315				GLX420320	GLX420400	GLX420500	GLX420630

CONTACT CHARACTERISTICS

IEC conventional free air thermal current I _{th} (≤40°C)	A	160	200	250	315	320	400	500	630	
IEC rated insulation voltage U _i	V	1000				1000				
IEC rated impulse withstand U _{imp}	kV	12				12				
IEC rated operational current I _e										
AC21A	400V	A	160	200	250	315	320	400	500	630
	500V	A	160	200	250	315	320	400	500	630
	690V	A	160	200	250	315	320	400	500	630
AC22A	400V	A	160	200	250	315	320	400	500	630
	500V	A	160	200	250	315	320	400	500	500
	690V	A	160	200	250	315	320	400	500	500
AC23A	400V	A	160	200	250	315	320	400	500	630
	500V	A	160	200	250	250	320	400	500	500
	690V	A	160	200	250	250	320	400	500	500
Power dissipation	W/pole	3.2	4	6.5	6.5	20.8	26.0	32.5	41.0	
IEC rated operational power										
AC23A	400V	kW	90	110	140	140	160	200	250	355
	690V	kW	144	200	250	250	315	400	500	500
IEC reactive power for control of capacitors 400V	kvar	80	100	115	145	145	180	200	250	

SHORT CIRCUIT PROTECTION

Rated short-time current I _{cs}	(1s)	kA rms	6				12.5			
	(0.3s)	kA rms	12				20			
Conditional short-circuit current		kA rms	100				80			
With fuse class gG	A		160	200	250	315	355	400	500	630
Making capacity AC23A 400V	A		1600	2000	2500	2500	3200	4000	5000	6300
Breaking capacity AC23A 400V	A		1280	1600	2000	2000	2560	3200	4000	5040
Mechanical life	cycles		20.000				10.000			
Terminal for busbars	mm		M8 x 20				M10 x 25			
Tightening torque	Nm		15...22				30...37			
	lb.in		132...194				265...327			
Conductor section min...max	mm ²		70...185				1 x 185...2 x 185①			
	AWG/ Kcmil		00...400				1 x 400...2 x 350			

AMBIENT CONDITIONS

Temperature	Operating	°C	-25...+55						
	Storage	°C	-40...+70						
Maximum altitude		m	3000						
Mounting position	Normal		Vertical						
	Admissible		Any						
Fixing			By screw. For GL0160...315 also on 35mm DIN rail (IEC/EN 60715)						

① For more details contact our Technical support; see contact details on inside front cover.

TECHNICAL DATA ACCORDING TO UL/CSA RATINGS

TYPE	3-pole	GL0100C1UL	GL0200C1UL	—	—	—	GL0400C1UL	—	—
	4-pole	GLX420100UL	GLX420200UL	—	—	—	GLX420400UL	—	—
Compliance		UL98 CSA C22.2 N°4	UL98 CSA C22.2 N°4	—	—	—	UL98 CSA C22.2 N°4	—	—
General purpose current ratings	A	100	200	—	—	—	400	—	—
Maximum operating voltage	V	600	600	—	—	—	600	—	—
Horsepower ratings /motor FLA current three-phase	240V	HP/A	30/80	75/192	—	—	125/312	—	—
	480V	HP/A	75/96	150/180	—	—	250/302	—	—
	600V	HP/A	100/99	200/192	—	—	350/336	—	—
		HP/A	100/99	200/192	—	—	350/336	—	—
Short circuit rating	KA rms	200	200	—	—	—	100	—	—
With fuse	class/A	J/100	J/200	—	—	—	J/400	—	—
Terminal kit lugs		GLX500-GLX501	GLX500-GLX501	—	—	—	GLX502-GLX503	—	—
Minimum enclosure dimensions at rated current	mm (in)	400 x 250 x 150 (15.8 x 9.9 x 5.9)	400 x 250 x 150 (15.8 x 9.9 x 5.9)	—	—	—	950 x 350 x 200 (37.4 x 13.8 x 7.9)	—	—

12 Switch disconnectors

Technical characteristics
GL series 100A to 630A - Changeover switches



INDEX

TECHNICAL DATA ACCORDING TO IEC/EN/BS 60947

TYPE	3-pole	GLC0160...	GLC0200...	GLC0250...	GLC0315...	GLC0320...	GLC0400...	GLC0500...	GLC0630...	
	4-pole	GLC0160T4...	GLC0200T4...	GLC0250T4...	GLC0315T4...	GLC0320T4...	GLC0400T4...	GLC0500T4...	GLC0630T4...	
CONTACT CHARACTERISTICS										
IEC conventional free air thermal current I _{th} (≤40°C)	A	160	200	250	315	320	400	500	630	
IEC rated insulation voltage U _i	V	1000				1000				
IEC rated impulse withstand U _{imp}	kV	12				12				
IEC rated operational current I _e										
AC31B	400V	A	160	200	250	315	320	400	500	630
	500V	A	160	200	250	315	320	400	500	630
	690V	A	160	200	250	315	320	400	500	630
AC32B	400V	A	160	200	250	315	320	400	500	630
	500V	A	160	200	250	315	320	400	500	500
	690V	A	160	200	250	315	320	400	500	500
AC33B	400V	A	160	200	250	315	320	400	500	630
	500V	A	160	200	250	250	320	400	500	500
	690V	A	160	200	250	250	320	400	500	500
Power dissipation	W/pole	3.2	4	6.5	6.5	20.8	26.0	32.5	41.0	
IEC rated operational power										
AC23A	400V	kW	90	110	140	140	160	200	250	355
	690V	kW	144	200	250	250	315	400	500	500
IEC reactive power for control of capacitors 400V	kvar	80	100	115	145	145	180	200	250	

SHORT CIRCUIT PROTECTION

Rated short-time current I _{cs}	(1s)	kA rms	6				12.5			
	(0.3s)	kA rms	12				20			
Conditional short-circuit current		kA rms	100				80			
With fuse class gG	A		160	200	250	315	355	400	500	630
Making capacity AC23A 400V	A		1600	2000	2500	2500	3200	4000	5000	6300
Breaking capacity AC23A 400V	A		1280	1600	2000	2000	2560	3200	4000	5040
Mechanical life	cycles		20.000				10.000			
Terminal for busbars	mm		M8 x 20				M10 x 25			
Tightening torque	Nm		15...22				30...37			
	lb.in		132...194				265...327			
Conductor section min...max	mm ²		70...185				1 x 185...2 x 185			
	AWG/Kcmil		00...400				1 x 400...2 x 350			

AMBIENT CONDITIONS

Temperature	Operating	°C	-25...+55						
	Storage	°C	-40...+70						
Maximum altitude		m	3000						
Mounting position	Normal		Vertical						
	Admissible		Any						
Fixing			By screw						

TECHNICAL DATA ACCORDING TO UL/CSA RATINGS

TYPE		GLC0100...UL	GLC0200...UL	—	—	—	GLC0400...UL	—	—
Compliance		UL1008 CSA C22.2 N°4	UL1008 CSA C22.2 N°4	—	—	—	UL1008 CSA C22.2 N°4	—	—
General purpose current ratings	A	100	200	—	—	—	400	—	—
Maximum operating voltage	V	600	600	—	—	—	600	—	—
Horsepower ratings /motor FLA current three-phase	240V	HP/A	30/80	75/192	—	—	125/312	—	—
	480V	HP/A	50/65	150/180	—	—	250/302	—	—
	600V	HP/A	50/52	200/192	—	—	350/336	—	—
Short circuit ratings	KA rms	100	200	—	—	—	100	—	—
With fuse	class/A	J/100	J/200	—	—	—	J/400	—	—
Terminal kit lugs		GLX500-GLX501	GLX500-GLX501	—	—	—	GLX502-GLX503	—	—
Minimum enclosure dimensions at rated current	mm (in)	400 x 250 x 150 (15.8 x 9.9 x 5.9)	400 x 250 x 150 (15.8 x 9.9 x 5.9)	—	—	—	950 x 350 x 260 (37.4 x 13.8 x 10.3)	—	—

12 Switch disconnectors

Technical characteristics
GE series 160 to 1600A - Three and four-pole

TYPE	3-pole		GE0160P GE0160	GE0200	GE0250	GE0251	GE0315	GE0400	GE0500	GE0630	GE0800	GE1000	GE1250	GE1600	
	4-pole ^⑥		GE0160T4P GE0160T4	GE0200T4	GE0250T4	GE0251T4	GE0315T4	GE0400T4	GE0500T4	GE0630T4	GE0800T4	GE1000T4	GE1250T4	GE1600T4	
CONTACT CHARACTERISTICS															
IEC conventional free air thermal current I _{th} (≤40°C)	A		160	200	250	250	315	400	500	630	800	1000	1250	1600	
IEC rated insulation voltage U _i	V	1000													
IEC rated impulse withstand U _{imp}	kV	8						12							
IEC rated operational current I _e															
AC21A	400V	A	160	200	250	250	315	400	500	630	800	1000	1250	1600	
	500V	A	160	200	200	250	315	400	500	630	800	1000	1250	1600	
	690V	A	160	180	180	200	250	250	500	630	800	1000	1000	1600	
AC22A	400V	A	160	200	250 (AC22B) 200 (AC22A)	250	315	400	500	630	800	1000	1250	1600	
	500V	A	160	200	200	250	315	400	500	630	800	1000	1000	1250	
	690V	A	125	160	160	160	200	200	400	500	500	630	630	1000	
AC23A	400V	A	160	160	160	250	315	400	500	630	800	1000	1000	1000	
	500V	A	125	125	125	200	250	315	400	500	500	800	800	900	
	690V	A	80	80	80	160	160	160	250	315	315	500	500	630	
Power dissipation	w/pole		4	6	9	2.5	6.5	10.5	22	35	56	50	78	128	
IEC reactive power for control of capacitors 400V senφ=0,65	kvar		72	72	72	112	142	180	225	284	284	360	360	450	
IEC rated operational power															
AC23A	400V	kW	90	90	90	138	174	220	220	349	443	443	443	554	
	690V	kW	75	75	75	153	153	153	239	300	300	478	478	600	
Short circuit protection															
Rated short-time current (1s) I _{cw}	kA rms		7			12			16			25		50	
Conditional short-circuit current ^①	kA rms		100											72	75
With fuse class gG	A		160	200	250		315	400	500	630	800	1000	1250	2x800	
Making capacity AC23A 400V	A		1600			2500	3150	4000	5000	6300		8000		10000	
Breaking capacity AC23A 400V	A		1280			2000	2520	3200	4000	5000		6400		8000	
Mechanical life	cycles		30,000			20,000			10,000						
Electrical life (AC23A 400V)	cycles		1,000								500				
Terminals	type		Lug terminal ^② or bars												
	A mm		18	26		25		25	30		40		60		
	B mm		3			4		5			8		10		
	screw		M8	M10						M14		M14			
Tightening torque	Nm		13 ^④	18			24			45		55			
	lb.in		88 ^④	159			212			292		487			
Max. conductor section	mm ²		95	120		185		2x185	2x240	2x240	2x300		—		
Max. bar size (thickness-width)	mm		5-25 ^⑤	5-30		7-25		6-40	2x 5-40	2x 5-50	2x 10-50		2x 10-80		
AMBIENT CONDITIONS															
Temperature	Operating	°C	-25...+55												
	Storage	°C	-40...+70												
Maximum altitude	m		3000												
Mounting position	Normal		Vertical												
	Admissible		Any												
Fixing			Screw												

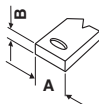

- ① With protection fuse limiting peak current and specific through energy.
- ② Not suitable for types GE0160P and GE0160T4P.
- ③ Types GE...P have hex terminals IP20.
- ④ 4Nm/35lb.in only for types GE...P.
- ⑤ The 4-pole types (3P+N) have early-make late-break neutral pole.

12 Switch disconnectors

Technical characteristics

GE series 50 to 800A - Three and for-pole with fuse holder

TYPE	NFC	3-pole	GE0050F	GE0125F	-	-	-
		4-pole ^②	GE0050FT4	GE0125FT4	-	-	-
BS		3-pole	-	-	GE0160B	-	GE0200B
		4-pole ^②	-	-	GE0160BT4	-	GE0200BT4
NH		3-pole	-	-	GE0160N	GE0161N	-
		4-pole ^②	-	-	GE0160NT4	GE0161NT4	-

CONTACT CHARACTERISTICS

IEC conventional free air thermal current I _{th} (≤40°C)	A	50	125	160	160	200	
IEC rated insulation voltage U _i	V	800	800	800	800	800	
IEC rated impulse withstand U _{imp}	kV	8	8	8	8	8	
IEC rated operational current I _e							
AC21A	400V	A	50	125	160	160	200
	500V	A	50	125	160	160	200
	690V	A	50	125	160	160	200
AC22A	400V	A	50	125	160	160	200
	500V	A	50	125	160	160	200
	690V	A	50	100	125	160	200
AC23A	400V	A	50	125	160	160	200
	500V	A	50	125	125	160	200
	690V	A	50	80	100	125	160
Power dissipation	NFC	W/pole	4.7	12.5	—	—	—
	BS	W/pole	—	—	12	—	13
	NH	W/pole	—	—	11.8	13.5	—
IEC reactive power for control of capacitors 400V	kvar	18	52	60	60	75	
IEC rated operational power AC23A	400V	kW	25	65	90	90	110
	690V	kW	42	80	90	110	132
Short circuit protection	Spec. through energy I ² t	kA ² s	0.076	0.19	0.19	0.478	0.478
	Conditional short circuit current	kA rms	50	50	100 ^①	100	100
Making capacity AC23A 400V	A	500	1250	1600	1600	2000	
Breaking capacity AC23A 400V	A	400	1000	1280	1280	1600	
Mechanical life	cycles	10,000	10,000	10,000	10,000	10,000	
Electrical life (AC23A 400V)	cycles	1,500	1,500	1,500	1,000	1,000	
Terminals		type	Ⓜ	Ⓜ	Lug terminal or bars		
		A mm	—	—	20	25	
		B mm	—	—	—	3	
		screw	M6	M6	—	M8	
Tightening torque	Nm	3	4	—	13		
	lb.in	26	35	—	115		
Max. conductor section	mm ²	35	93	95	120		
Max. bar size (thickness-width)	mm	—	—	3-25	5-25		

AMBIENT CONDITIONS

Temperature	Operating	°C	-25...+55
	Storage	°C	-40...+70
Maximum altitude	m	3000	
Mounting position	Normal	Vertical	
	Admissible	Any	
Fixing		Screw	

① 50kA rms for types GE0160N and GE0160NT4.

② Types GE...F have hex terminals IP20.

③ The 4-pole types (3P+N) have early-make late-break neutral pole.

12 Switch disconnectors

Technical characteristics

GE series 50 to 800A - Three and for-pole with fuse holder

	-	-	-	-	-
	-	-	-	-	-
	GE0250B	GE0315B	GE0400B	GE0630B	GE0800B
	GE0250BT4	GE0315BT4	GE0400BT4	GE0630BT4	GE0800BT4
	GE0250N	-	GE0400N	GE0630N	GE0800N
	GE0250NT4	-	GE0400NT4	GE0630NT4	GE0800NT4
	250	315	400	630	800
			1000		
			12		
	250	315	400	630	800
	250	315	400	630	800
	250	315	400	630	630
	250	315	400	630	800
	250	315	400	630	800
	250	315	400	630	630
	250	315	400	630	630
	250	315	400	630	630
	200	250	315	400	400
	—	—	—	—	—
	12	24	29	44	63
	18.7	—	30	48	57
	115	150	200	250	325
	132	185	220	355	355
	160	200	250	370	370
	1.6	1.6	1.6	4.6	4.6
	100	100	100	100	100
	2500	3150	4000	6300	
	2000	2600	3200	5100	
		10,000		5,000	
		1.000			500
		Lug terminal or bars			
	30		35	40	50
	4		5	6	
		M10		M12	4x M8
		24		45	13
		212		396	115
		240		2 x 185	2 x 240
		6-40		2 x 7-50	2 x 7-50
			-25...+55		
			-40...+70		
			3000		
			Vertical		
			Any		
			Screw		

- ① 50kA rms for types GE0160N and GE0160NT4.
- ② Types GE...F have hex terminals IP20.
- ③ The 4-pole types (3P+N) have early-make late-break neutral pole.

12 Switch disconnectors

Technical characteristics

GE series 160A to 3150A - Three and four-pole changeover switches



INDEX

TYPE	3-pole	GE0160E	GE0200E	GE0201E	GE0250E	GE0315E	GE0400E	
	4-pole ^②	GE0160ET4	GE0200ET4	GE0201ET4	GE0250ET4	GE0315ET4	GE0400ET4	
CONTACT CHARACTERISTICS								
IEC conventional free air thermal current I _{th} (≤40°C)	A	160	200		250	315	400	
IEC rated insulation voltage U _i	V	1000						
IEC rated impulse withstand U _{imp}	kV	8						
IEC rated operational current I _e								
AC21A	400V	A	160	200	200	250	315	400
	500V	A	160	200	200	250	315	400
	690V	A	160	200	200	250	315	400
AC22A	400V	A	160	200	200	250	315	400
	500V	A	160	200	200	250	315	400
	690V	A	125	160	160	200	250	315 ^③
AC23B	400V	A	160	160	160	180	200	250
	500V	A	125	125	125	150	160	200
	690V	A	80	80	80	100	125	160
Power dissipation	W/pole	4	6	8	8,5	13,5	22	
IEC reactive power for control of capacitors 400V	kvar	72	72	83	104	131	166	
IEC rated operational power AC23A	400V	kW	89	89	100	100	125	125
	690V	kW	76	76	69	86	108	138
Short circuit protection								
Rated short-time current (1s) I _{cs}	kA rms	7	7	8				
Conditional short-circuit current ^①	kA rms	100	100	100				
With fuse class gG	A	160	200	250	315	400		
Making capacity AC23A 400V	A	1600	1600	3150	4000			
Breaking capacity AC23A 400V	A	1280	1280	2520	3200			
Mechanical life	cycles	30,000	30,000	10,000				
Electrical life (AC22A 400V)	cycles	1,000	1,000	1,000				
Terminals	type	Lug terminal or bars						
	A mm	18	26	25			35	
	B mm	3						
	screw	M8			M10			
Tightening torque	Nm	13			24			
	lb.in	115			212			
Max. conductor section	mm ²	95	120	240				
Max. bar size (thickness-width)	mm	4-13	13-18	2 x 5-30				
AMBIENTAL CONDITIONS								
Temperature	Operating	°C	-25...+55					
	Storage	°C	-40...+70					
Maximum altitude	m	3000						
Mounting position	Normal	Vertical						
	Admissible	Any						
Fixing		Screw						

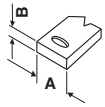

- ① With protection fuse limiting peak current and specific through energy.
- ② The 4-pole types (3P+N) have early-make late-break neutral pole.
- ③ Value in AC22B.

12 Switch disconnectors

Technical characteristics

GE series 160A to 3150A - Three and four-pole changeover switches

	GE0500E	GE0630E	GE0800E	GE1000E	GE1250E	GE1600E	GE2000E	GE2500E	GE3150E
	GE0500ET4	GE0630ET4	GE0800ET4	GE1000ET4	GE1250ET4	GE1600ET4	GE2000ET4	GE2500ET4	GE3150ET4
	500	630	800	1000	1250	1600	2000	2500	3150
	1000								
	12						8		
	500	630	800	1000	1250	1600	2000	2500	3150
	500	630	800	1000	1250	1600	2000	2500	3150
	500	630	800	1000	1250	1600	1800	2500	2500
	500	630	800	1000	1250	1600	2000	2500	2500
	500	630	800	1000	1250	1250	1800	1800	2000
	400	500	630 ^②	800	1000 ^②	1000	1600	1800	1800
	400	500	630	1000	1000	1000	1250	1800	1800
	250	315	400	800	900	900	900	1250	1400
	250	250	315	630	630	630	630	1000	1000
	28	44,5	72	76	118	128	59,60	213	338
	208	262	333	415	415	450	562	811	900
	200	200	315	500	525	550	692	997	1100
	173	216	272	544	575	600	764	956	956
	13			25		35	50		
	100			72			75	100	100
	500	630	800	1000	1250	2 x 800	–	–	–
	6300		8000	10000	10000	10000	12500	18000	20000
	5040		6400	8000	8000	8000	10000	14400	1600
	10,000		10,000				3000	600	
	1,000		500						
	Lug terminal or bars								
	40			50		60	80		100
	5			6		10	10	2 x 15	
	M12			M14		M14	M14	M12	
	24			45		55	55	45	
	212			398		487	487	398	
	2 x 240			–	–	–	–	–	–
	2 x 6-45			2 x 10-60		2 x 7-80	2 x 10-80	3 x 12-80	3 x 12-100
	-25...+55						-30...+70		
	-40...+70						-40...+75		
	3000								
	Vertical								
	Any								
	Screw								

① With protection fuse limiting peak current and specific through energy.
 ② The 4-pole types (3P+N) have early-make late-break neutral pole.
 ③ Value in AC22B.

12 Switch disconnectors

Technical characteristics

GM series 30A to 800A - Three-pole with fuse holder (UL98)



INDEX

TECHNICAL DATA ACCORDING TO IEC/EN/BS 60947

TYPE	3-pole	GMF...030...	GMFJ060...	GMFJ100C03	GMFJ200C03	GMFJ400C03	GMFJ600C03	GMFL800C03	
CONTACT CHARACTERISTICS									
IEC conventional free air thermal current I _{th} (≤40°C)	A	32	63	160	200	400	630	800	
IEC rated insulation voltage U _i	V	1000							
IEC rated impulse voltage withstand U _{imp}	kV	12							
IEC rated operational current I _e									
AC21A	400V	A	32	63	160	200	400	630	800
	500V	A	32	63	160	200	400	630	800
	690V	A	32	63	160	200	400	630	800
AC22A	400V	A	32	63	160	200	400	630	800
	500V	A	32	63	160	200	400	630	800
	690V	A	32	63	160	200	400	630	800
AC23A	400V	A	32	63	160	200	400	630	800
	500V	A	32	63	160	200	400	630	800
	690V	A	32	63	160	200	400	630	800
Power dissipation (without fuse)	W/pole	2	4	9	8	30	46	75	
Max fuse power dissipation	in open air	W	3.5	7.5	12	17	45	60	65
	in enclosure	W	3.5	7.5	12	15	30	50	55
IEC rated operational power									
AC23A	400V	kW	15	30	75	110	220	355	450
	690V	kW	22	55	132	200	400	630	710
IEC short circuit protection									
Rated short-time current (1s) I _{cw}	kA rms	1	2.5	5	8	14	20	20	
Conditional short circuit current	kA rms	200							
With fuse	A/class	30/J-CC	60/J	100/J	200/J	400/J	600/J	800/L	
Making capacity AC23A 690V	A	320	630	1600	2000	4000	6300	8000	
Breaking capacity AC23A 690V	A	256	504	1280	1600	3200	6400	6400	
Mechanical life	cycles	10,000		8,000		5,000		3,000	
Min. electrical endurance (pf=0.75...0.8)	cycles	6000				1000	1000	500	
Fuse-links bolts tightening torque	Nm	-	-	4	4	20	40	40	
Terminal lug kits		Built-in		GMX500	GMX501	GMX502	GMX504	GMX504	
Conductor section min...max	mm ²	1...10	2.5...25	2.5...70	25...150	35...300	2X35...600	2X35...600	
	AWG	18-8	14-4	14-2/0	4-300MCM	2-600MCM	(2)x2-600MCM	(2)x2-600MCM	
Conductor tightening torque	Nm	2	3.5	13.5	31	42.5	56.5	56.5	
	lb.in	17	30	120	275	375	500	500	
Terminal lugs tightening torque	Nm	-	-	5.5	8	27	54	54	
	lb.in	-	-	50	72	240	480	480	

AMBIENT CONDITIONS

Temperature	operating	°C	-25...+55					
	storage	°C	-40...+70					
Maximum altitude	m	3000						
Mounting position	normal	Vertical						
	admissible	Any						
Fixing		Screw or 35mm DIN rail (IEC/EN 60715)	Screw					

TECHNICAL DATA ACCORDING TO UL/CSA RATINGS

TYPE	3-pole	GMF...030...	GMFJ060...	GMFJ100C03	GMFJ200C03	GMFJ400C03	GMFJ600C03	GMFL800C03	
CHARACTERISTICS									
Compliance		UL98							
General purpose rating (≤40°C)	A	30	60	100	200	400	600	800	
Max operating voltage U _i	V	600							
Horsepower ratings/motor FLA current three-phase									
	240V	HP/A	7.5/22	15/42	30/80	60/154	125/312	200/480	250/602
	480V	HP/A	15/21	30/40	60/77	125/156	250/302	400/477	500/590
	600V	HP/A	20/22	50/52	75/77	150/144	350/336	500/472	600/472
Short circuit ratings	KA rms	200							
With fuse	A/class	30/J-CC	60/J	100/J	200/J	400/J	600/J	800/L	
Terminal lug kits		Built-in		GMX500	GMX501	GMX502	GMX504	GMX504	

12 Switch disconnectors

Technical characteristics
GA and GD series for photovoltaic applications

TYPE	3-pole	GA040D	GD025AT2	GD025AT3	GD032AT3	GD032AT4	GD040AT3	GD040AT4
	4th pole	GAX42040D	—	—	—	—	—	—
CONTACT CHARACTERISTICS								
IEC conventional free air thermal current I _{th} (≤40°C)	A	40	25	25	32	32	40	40
IEC rated insulation voltage U _i	V	1000	1000 / 1500 ^①					
IEC rated impulse withstand U _{imp}	kV	8						
IEC rated operational current I _e DC21B ^②								
	≤800V	A	—	25	25	32	32	40
	1000V	A	—	16	25	32	32	40
	①1200V	A	—	—	—	—	25	32
	①1500V	A	—	—	—	—	20	25
2 poles in series	300V	A	16	—	—	—	—	—
3 poles in series	48V	A	40	—	—	—	—	—
	110V	A	35	—	—	—	—	—
	220V	A	32	—	—	—	—	—
	500V	A	12	—	—	—	—	—
4 poles in series	400V	A	35	—	—	—	—	—
	440V	A	32	—	—	—	—	—
	500V	A	32	—	—	—	—	—
	600V	A	20	—	—	—	—	—
	700V	A	15	—	—	—	—	—
	750V	A	15	—	—	—	—	—
	800V	A	15	—	—	—	—	—
	Power dissipation	w/pole	1.0	0.8		1.2		1.9
Mechanical life	cycles	100,000	10,000					
Terminals	type	Mantle	Screw with washer					
	A mm	5.6	—					
	B mm	6.5	—					
	Screw	M4	—					
	Tool	Phillips 2	Phillips 1					
	Tightening torque	Nm	1.8...2	1.2...1.6				
	lb.in	16...18	10...14					
Conductor section min.-max.	mm ²	0.75...16	1...10					
	AWG	18...6	18...8					
AMBIENT CONDITIONS								
Temperature	Operating	°C	-25...+55					
	Storage	°C	-40...+70					
Maximum altitude	m	3,000	2,000					
Mounting position	Normal		Vertical					
	Admissible		Any					
Fixing		Screw or 35mm DIN rail (IEC/EN 60715)						



① 1000V pollution degree 3; 1500V pollution degree 2.
② For GD series refer to wiring diagrams on page 12-63.

12 Switch disconnectors

Technical characteristics
GE series for photovoltaic applications

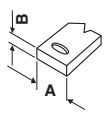

INDEX

TYPE	4-pole	GE0125DT4	GE0250DT4	GE0315DT4	
CONTACT CHARACTERISTICS					
IEC conventional free air thermal current I _{th} (≤40°C)	A	125	250	315	
IEC rated insulation voltage U _i	V	1000			
IEC rated impulse withstand U _{imp}	kV	8			
IEC rated operational current I _e DC21B	48V A	125	250	315	
4 poles in series	110V A	125	250	315	
	220V A	125	250	315	
	400V A	125	250	315	
	440V A	125	250	315	
	500V A	125	250	315	
	600V A	125	250	315	
	750V A	125	250	290	
	800V A	125	250	280	
	850V A	125	240	270	
	900V A	125	220	260	
1000V A	100	100	250		
Power dissipation	w/pole	0.7	2.7	4.2	
Mechanical life	cycles	20,000			
Terminals		type	Lug terminal or bars		
		A mm	20	25	25
		B mm	4	4	4
		screw	M8	M10	M10
Tightening torque	Nm	13	18	18	
	lb.in	115	159	159	
Max. bar size (thickness-width)	mm	7-25			
Max. conductor section	mm ²	185			
AMBIENT CONDITIONS					
Temperature	Operating	°C	-25...+55		
	Storage	°C	-40...+70		
Maximum altitude		m	3000		
Mounting position	Normal		Vertical		
	Admissible		Any		
Fixing			Screw		

12 Switch disconnectors

Technical characteristics
GE series for photovoltaic applications

	GE0630DT4	GE0800DT4	GE1250DT4
	630	800	1250
		1000	
		12	
	630	800	1250
	630	800	1250
	630	800	1250
	630	800	1250
	630	750	1250
	630	700	1250
	630	700	1250
	630	650	1050
	600	630	1000
	600	630	940
	600	630	870
	500	630	850
	15.5	24.7	36.1
		10,000	
		Lug terminal or bars	
	30	30	40
	5	5	8
	M10	M10	M14
	24	24	45
	212	212	398
	2x 5-40 (thickness-width)	2x 5-40	2x 10-50
	2x240	2x240	2x300
		-25...+55	
		-40...+70	
		3000	
		Vertical	
		Any	
		Screw	



- Modular size for 10x38, 10x85, 14x51, 14x85 and 22x58mm fuses
- Finger safe - IEC IP20 degree of protection against accidental contact with live parts and with sealable cover for operator safety
- Version with status indicator to quickly determine if the fuse is still operative or needs to be replaced
- UL and CSA certified versions
- Versions for photovoltaic applications.

	SEC. - PAGE
Fuse holders	
AC fuse holders	13 - 2
AC fuse holders class CC for the North American market	13 - 3
DC fuse holders for photovoltaic applications	13 - 4
Fuses for photovoltaic applications	13 - 4
Accessories	13 - 5
Dimensions	13 - 6
Wiring diagrams	13 - 6
Technical characteristics	13 - 7



Page 13-2

AC FUSE HOLDERS

- Version without indicator: 1P, 1P+N, 2P, 3P, 3P+N
- Version with indicator: 1P
- For fuses 10x38, 14x51 and 22x58mm IEC class gG or aM.
- IEC rated current: 32A, 50A, 100A
- IEC rated voltage: 690VAC.



Page 13-3

AC FUSE HOLDERS CLASS CC FOR THE NORTH AMERICAN MARKET

- Version without indicator: 1P, 2P, 3P
- Version with indicator: 1P
- For 10x38mm UL/CSA class CC fuses
- IEC rated current: 30A
- IEC rated voltage: 600VAC.



Page 13-4

DC FUSE HOLDERS FOR PHOTOVOLTAIC APPLICATIONS

- Version without indicator: 1P, 2P
- Version with indicator: 1P, 2P
- For 10x38, 10x85 and 14x85mm IEC class gPV fuses
- IEC rated current: 32A
- IEC rated voltage: 1000VDC and 1500VDC
- IEC utilisation category: DC20B.



Page 13-4

DC FUSES FOR PHOTOVOLTAIC APPLICATIONS

- 10x38mm, IEC class gPV
- 10x85 and 14x85mm, IEC class gPV
- Rated current: 20A
- Rated voltage: 1000VDC and 1500VDC.

Fuse holders UL Recognized



FB01F... FB01F1PL



FB02A... FB02A1PL



FB03A... FB03A1PL

Order code	Pole arrangement	Status indicator	DIN size	Qty per pkg	Wt
			n°	n°	[kg]

For 10x38mm fuses.
IEC 32A rated current at 690VAC.

FB01F1P	1P	—	1	12	0.066
FB01F1PL	1P	YES	1	12	0.065
FB01F1M Ⓢ	1P+N	—	1	12	0.062
FB01F1N	1P+N	—	2	6	0.134
FB01F2P	2P	—	2	6	0.132
FB01F3P	3P	—	3	4	0.188
FB01F3N	3P+N	—	4	3	0.260

For 14x51mm fuses.
IEC 50A rated current at 690VAC.

FB02A1P	1P	—	1.5	6	0.113
FB02A1PL	1P	YES	1.5	6	0.114
FB02A1N	1P+N	—	3	3	0.237
FB02A2P	2P	—	3	3	0.224
FB02A3P	3P	—	4.5	2	0.335
FB02A3N	3P+N	—	6	1	0.460

For 22x58mm fuses.
IEC 100A rated current at 690VAC.

FB03A1P	1P	—	2	6	0.167
FB03A1PL	1P	YES	2	6	0.167
FB03A1N	1P+N	—	4	3	0.354
FB03A2P	2P	—	4	3	0.334
FB03A3P	3P	—	6	2	0.500
FB03A3N	3P+N	—	8	1	0.720

- Ⓢ Not certified cURus.
- Ⓢ Use with gG/aM class 125A fuses, not dissipating more than 12W power.

NOTE:
For FB01 F type: UL Recognized as "Fuseholders - Component". Current rating: 30A. Voltage rating: 750V max. CSA certified as "Fuseholder Assemblies". Current rating: 30A. Voltage rating: 600V max.
For FB02 A type: UL Recognized as "Fuseholders - Component". Current rating: 50A. Voltage rating: 750V max.
For FB03 A type: UL Recognized as "Fuseholders - Component". Current rating: 100A. Voltage rating: 750V max.

Operational characteristics

- IEC rated voltage Un: 690VAC
- IEC rated current In:
 - FB01F: 32A
 - FB02A: 50A
 - FB03A: 100AⓈ
- IEC utilisation category:
 - FB01F: AC22B 500V, AC21B 690V
 - FB02A: AC22B 500V, AC21B 690V
 - FB03A: AC21B 690V
- Suitable for IEC fuse class: gG and aM
- IEC degree of protection: IP20.

Certifications and compliance

Type	CSA certified (File 252040 class 3211)	UL Recognized for USA and Canada (cURus - File E343395)
FB01F...	●	●
FB02A...	—	●
FB03A...	—	●

● Certification obtained.

cURus - "UL Recognized": Products having this type of marking are intended for use as components of complete workshop-assembled equipment.

Certifications obtained: EAC.
Compliant with standards: IEC/EN/BS 60269-1, IEC 60269-2, IEC/EN/BS 60947-1, IEC/EN/BS 60947-3, UL 4248-1, UL 4248-4, CSA C22.2 n°4248.1, CSA C22.2 n°4248.4.

Fuse holder combinations

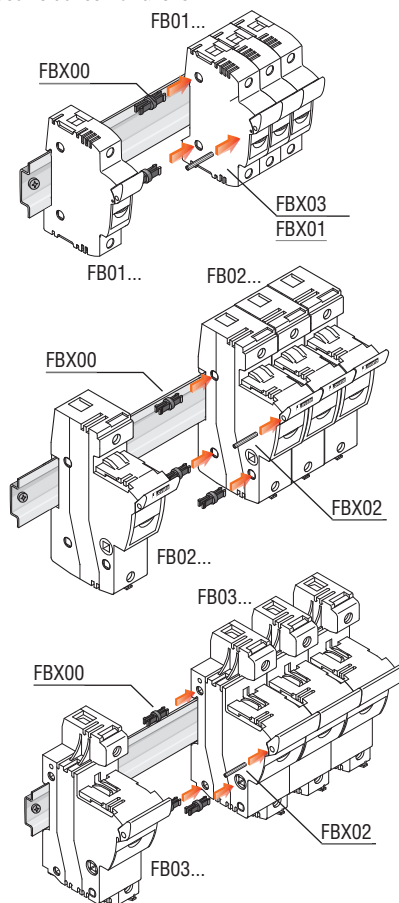

Fuse holders



FB01B...

FB01B1PL

Order code	Pole arrangement	Status indicator	DIN size	Qty per pkg	Wt
			n°	n°	[kg]

For 10x38mm fuses.
IEC 32A rated current at 690VAC.

FB01B1P	1P	—	1	12	0.062
FB01B1PL	1P	YES	1	12	0.064
FB01B1N	1P+N	—	2	6	0.127
FB01B2P	2P	—	2	6	0.128
FB01B3P	3P	—	3	4	0.185
FB01B3N	3P+N	—	4	3	0.247

Operational characteristics

- IEC rated voltage Un: 690VAC
- IEC rated current In: 32A
- IEC utilisation category: AC22B 500V, AC21B 690V
- Suitable for IEC fuse class: gG and aM
- IEC degree of protection IP20.

Certifications and compliance

Certifications obtained: EAC.
Compliant with standards: IEC/EN/BS 60947-1, IEC/EN/BS 60947-3, IEC/EN/BS 60269-1, IEC 60269-2.

Fuse holders UL Listed and CSA Certified for class CC fuses for the North American market



FB01G...

FB01G1PL

Order code	Pole arrangement	Status indicator	DIN size	Qty per pkg	Wt
			n°	n°	[kg]

For 10x38mm fuses.
IEC 30A rated current at 600VAC.

FB01G1P	1P	—	1	12	0.070
FB01G1PL	1P	YES	1	12	0.072
FB01G2P	2P	—	2	6	0.140
FB01G3P	3P	—	3	4	0.210

NOTE: UL Listed and CSA certified as "Fuseholders, Cartridge Fuse" for use with Class CC fuses. Interrupting rating 200,000 Amps rms symmetrical. Voltage rating 600V. Current rating 30A.

Operational characteristics

- IEC rated voltage Un: 600VAC
- IEC rated current In: 30A
- IEC utilisation category: AC22B 500V, AC21B 690V
- Suitable for UL/CSA fuse class: CC
- IEC degree of protection IP20.

Certifications and compliance

Certifications obtained: UL Listed for USA (UL - File E343395) and CSA certified for Canada only (File 252040 class 6225), EAC.
Compliant with standards: IEC/EN/BS 60269-1, IEC 60269-2, IEC/EN/BS 60947-1, IEC/EN/BS 60947-3, UL 4248-1, UL 4248-4, CSA C22.2 n°4248.1, CSA C22.2 n°4248.4.

13 Fuse holders and fuses

DC fuse holders for photovoltaic applications.

Fuse holders for photovoltaic applications UL Listed / CSA certified up to 1000VDC



FB01D... FB01D1PL

Order code	Pole arrangement	Status indicator	DIN size	Qty per pkg	Wt
			n°	n°	[kg]

For 10x38mm fuses.
IEC 32A rated current at 1000VDC.

FB01D1P	1P	—	1	12	0.064
FB01D1PL	1P	YES	1	12	0.065
FB01D2P	2P	—	2	6	0.127
FB01D2PL	2P	YES	2	6	0.130

NOTE: UL Listed and CSA certified as "Photovoltaic fuseholders" for use with Photovoltaic Fuses. Interrupting rating 30,000 DC Amps. Voltage rating 1000V. Current rating 30A.

Operational characteristics

- IEC rated voltage Un: 1000VDC
- IEC rated current In: 32A
- IEC utilisation category: DC20B 1000VDC
- Suitable for IEC fuse class: gPV
- IEC degree of protection: IP20.

Certifications and compliance

Certifications obtained: UL Listed for USA (UL - File E366062) and CSA certified for Canada (File 252040 class 3211), EAC.
Compliant with standards: IEC/EN/BS 60269-1, IEC 60269-2, IEC/EN/BS 60947-1, IEC/EN/BS 60947-3, UL 4248-1, UL4248-18, CSA C22.2 n° 4248-1, CSA C22.2 n° 4248-18.

Fuses for photovoltaic applications up to 1000VDC



FE01D...

Order code	Rated current In	Qty per pkg	Wt
	[A]	n°	[kg]

10x38mm fuses.
IEC 30kA breaking capacity at 1000VDC.

FE01D00200	2	10	0.008
FE01D00400	4	10	0.008
FE01D00600	6	10	0.008
FE01D00800	8	10	0.008
FE01D01000	10	10	0.008
FE01D01200	12	10	0.008
FE01D01600	16	10	0.008
FE01D02000	20	10	0.008

Operational characteristics

- IEC rated voltage Un: 1000VDC
- IEC rated current In: 2...20A
- IEC fuse class: gPV.

Certifications and compliance

Certifications obtained: EAC.
Compliant with standards: IEC/EN/BS 60269-6.

Fuse holders for photovoltaic applications up to 1500VDC



FB04D1P FB04D1PL

new

Order code	Pole arrangement	Status indicator	Qty per pkg	Wt
			n°	[kg]

10x85mm and 14x85mm fuses.
IEC 32A rated current at 1500VDC.

FB04D1P	1P	No	6	0.109
FB04D1PL	1P	Yes	6	0.110

Operational characteristics

- IEC rated voltage Un: 1500VDC
- IEC rated current In: 32A
- IEC utilisation category: DC20B 1500VDC
- Suitable for IEC fuse class: gPV
- IEC degree of protection: IP20.

Certifications and compliance

Compliant with standards: IEC/EN/BS 60947-3.

Fuses for photovoltaic applications up to 1500VDC



FE05D... FE04D...

new

Order code	Rated current In	Qty per pkg	Wt
	[A]	n°	[kg]

10x85mm fuses.
IEC 10kA breaking capacity at 1500VDC.

FE04D006	6	10	0.019
FE04D010	10	10	0.019
FE04D015	15	10	0.019
FE04D020	20	10	0.019

14x85mm fuses.
IEC 10kA breaking capacity at 1500VDC.

FE05D020	20	5	0.031
FE05D025	25	5	0.031
FE05D032	32	5	0.031

Operational characteristics

- IEC rated voltage Un: 1500VDC
- IEC rated current
 - In: 6...20A for 10x85mm version
 - In: 20...32A for 14x85mm version
- Suitable for IEC fuse class: gPV.

Certifications and compliance

Compliant with standards: IEC/EN/BS 60269-6.

Accessories



FBX00



FBX01
FBX03



FBX02

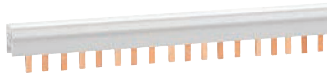

P1X9033



P1X9133



P1X9201



P1X9210



P1X9202

Order code	Description	Qty per pkg	Wt [kg]
FBX00	Coupling clip for 10x38, 14x51 and 22x58mm sizes	100	0.003
FBX01	Coupling pin for 10x38mm size type <u>FB01B1P</u> and <u>FB01B1PL</u> only	100	0.005
FBX02	Coupling pin for 14x51 and 22x58mm sizes	100	0.008
FBX03	Coupling pin for 10x38mm size types <u>FB01F</u> , <u>FB01G</u> , <u>FB01D</u> only	100	0.005
For <u>FB01F</u> , <u>FB01B</u> , <u>FB01D</u> and <u>FB01G</u> types ^② .			
P1X9031 ①	Single-pole supply busbar	10	0.160
P1X9032 ①	Two-pole supply busbar	10	0.320
P1X9033 ①	Three-pole supply busbar	10	0.474
P1X9034 ①	Four-pole supply busbar	10	0.600
P1X9130 ①	Kit of 5 isolating covers for unused busbar terminals	10	0.030
P1X9131 ①	End cap for P1X9031	50	0.001
P1X9132 ①	End cap for P1X9032	50	0.001
P1X9133 ①	End cap for P1X9033	50	0.001
P1X9134 ①	End cap for P1X9034	50	0.001
P1X9201 ①	Single-pole terminal for busbar supply; conductor cross section 25mm ² max.; tightening torque 2Nm	25	0.010
P1X9210 ①	Single-pole terminal for supplying busbar; conductor cross section 25mm ² max.; left entry; tightening torque 2Nm	25	0.010
P1X9202 ①	Single-pole terminal for busbar supply; conductor cross section 50mm ² max.; tightening torque 3.5Nm	25	0.022

General and operational characteristics

SINGLE-POLE SUPPLY BUSBAR

- Rated operational voltage U_e: 1000V
- Central point of power supply: 100A max.
- Side point of power supply: 63A max.
- Spacing: 17.5mm/0.69"
- Busbar section: 10mm²
- For paralleling connection
- For 57 modules, 1000mm/39.37" long (57 1P fuseholders)
- Length can be cut in shorter sections.

TWO-POLE, THREE-POLE AND FOUR-POLE SUPPLY BUSBARS

- Rated operational voltage U_e: 690V
- Central point of power supply: 100A max.
- Side point of power supply: 63A max.
- Spacing: 18mm/0.71"
- Busbar section: 10mm²
- For paralleling connection
- Two-pole: for 56 modules, 1000mm/39.37" long (28 2P fuseholders)
- Three-pole: for 57 modules, 1012mm/39.84" long (19 3P fuseholders)
- Four-pole: for 56 modules, 1000mm/39.37" long (14 4P fuseholders)
- Length can be cut in shorter sections.

Certification and compliance

Certifications obtained: EAC.

① See technical characteristics under derating factor of FB01... type for derating factor.

② When used with FB01D, rated operational voltage has to be checked.

FB01F... FB01G...

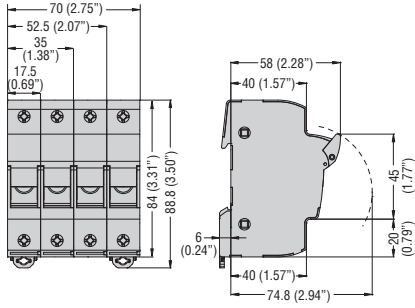

FB01B...

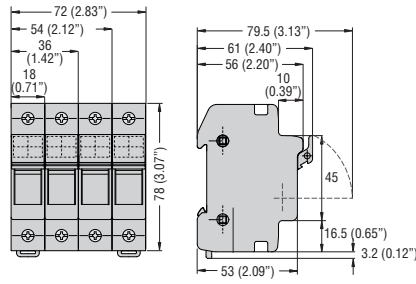

FB02A...

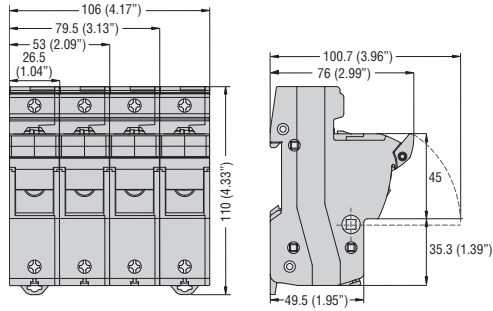

FB03A...

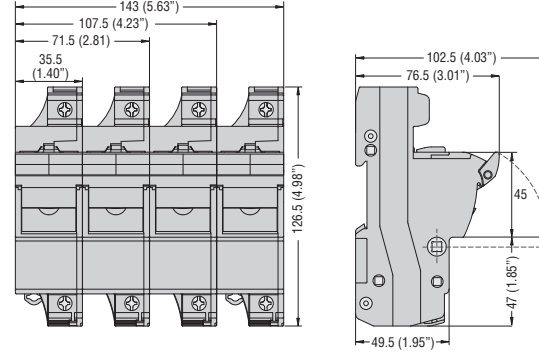

FB01D...

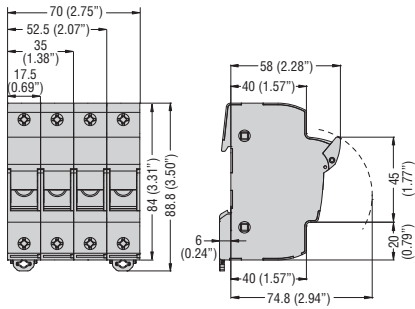

FB04D...

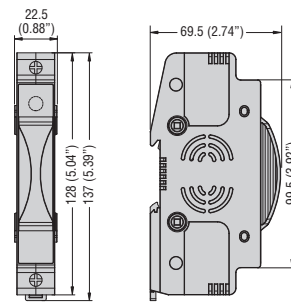

FUSES

FE01D0...

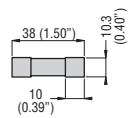

FE04D...

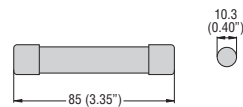

FE05D...

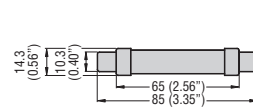

Wiring diagrams

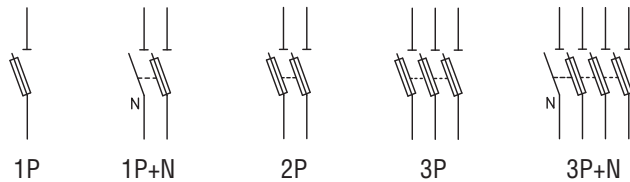

TYPE	FB01F...	FB01B...	FB02A...	FB03A...	FB01G...	FB01D...	FB04D...
Range	AC				Class CC (AC)	DC	DC
IEC maximum rated current In	32A		50A	100A [Ⓢ]	30A	32A	32A
IEC maximum rated voltage Un	690VAC;	690VAC			600VAC	1000VDC	1500VDC
IEC utilisation category	AC22B 500V; AC21B 690V;			AC21B 690V	AC22B 500V; AC21B 690V	DC20B 1000VDC	DC-PV0 1500VDC
Maximum power dissipation	3W		5W	9.5W	3W	4W	8W
Derating factor of current In for different ambient temperatures	20°C	1					1
	30°C	0.95					0.98
	40°C	0.9					0.94
	50°C	0.8					0.88
	60°C	0.7					0.83
Derating factor of current In for side-by-side fuse holders - number of poles	70°C	0.5					0.75
	1-4	1					-
	5-6	0.8					-
	7-9	0.7					-
	≥10	0.6					-
Voltage for status indicator	120...690VAC		230...690VAC		120...600VAC	350...1000VDC	800...1500VDC

CONNECTIONS

Maximum tightening torque	1.5Nm / 13.3lb.in		3Nm / 26lb.in	4Nm / 35lb.in	2.5Nm / 22lb.in		2.5Nm / 22lb.in
Maximum conductor cross section	flexible/stranded	1x16mm ² ; 1x6mm ² / 8AWG		1x25mm ² / 6AWG	1x35mm ² / 2AWG	1x16mm ² / 8AWG	1x16mm ² / 8AWG
	rigid/solid	1x16mm ² ; 1x10mm ² / 8AWG		1x35mm ² / 8AWG	1x50mm ² / 1AWG	1x16mm ² / 8AWG	1x16mm ² / 8AWG

AMBIENT CONDITIONS

Operating temperature	-20...+70°C						
Storage temperature	-40...+80°C						
Maximum altitude	3,000m						
Operation position	Any						
Fixing	On 35mm DIN rail (IEC/EN/BS 60715)						

Ⓢ Use with gG/aM class 125A fuses, not dissipating more than 12W power.

TECHNICAL CHARACTERISTICS FOR FE01D..., FE04D... AND FE05D... FUSES

TYPE	Rated current [A]	Power consumption at 0.7 In [W]	Power consumption at In [W]	Prearcing I ² t [A ² s]	Total I ² t at 1000VDC [A ² s]
FE01D00200	2	0.78	1.45	0.62	1
FE01D00400	4	0.64	1.57	6.90	11
FE01D00600	6	0.77	1.84	24	38
FE01D00800	8	0.82	2.00	7	17
FE01D01000	10	0.94	2.20	15	48
FE01D01200	12	0.98	2.40	27	68
FE01D01600	16	1.10	2.70	89	165
FE01D02000	20	1.33	3.20	158	294
FE04D006	6	1.1	2.7	68	88
FE04D010	10	1.4	3.5	45	75
FE04D015	15	1.9	2.7	171	295
FE04D020	20	2.0	5.2	240	480
FE05D020	20	2.2	5.3	68	225
FE05D025	25	2.5	6.4	140	458
FE05D032	32	3.1	8.0	270	890



- UL 1077 and UL 489 certified versions
- High breaking capacity
- Various trip characteristic curves: Type B, C or D
- Wide 1...125A current range
- Residuals with trip characteristic curves type A, AC and B
- Switch disconnectors
- Accessories available.

	SEC. - PAGE
Miniature circuit breakers 1...63A, UL 1077	
1P - 10kA, 1 module, curve types B, C and D	14 - 2
1P+N - 6kA, 1 module, curve type C	14 - 3
1P+N - 6kA, 2 modules, curve type C	14 - 3
2P - 10kA, 2 modules, curve types B, C and D	14 - 4
3P - 10kA, 3 modules, curve types B, C and D	14 - 5
4P - 10kA, 4 modules, curve types B, C and D	14 - 6
Miniature circuit breakers 1...63A, UL 489	
1P - 10kA, 1 module	14 - 7
2P - 10kA, 2 modules	14 - 8
3P - 10kA, 3 modules	14 - 9
Miniature circuit breakers 80...125A, UL 1077	
1P, 2P, 3P and 4P - 10kA, curve type C	14 - 10
3P and 4P - 10kA, curve type D	14 - 10
Add-on blocks and accessories	14 - 11
Modular switch disconnectors	14 - 13
Residual blocks	14 - 13
Residual current operated circuit breakers	14 - 14
Residual current operated circuit breakers with overcurrent protection	14 - 15
Dimensions	14 - 16
Wiring diagrams	14 - 16
Technical characteristics	14 - 17



Page 14-2

MINIATURE CIRCUIT BREAKERS UP TO 63A

- 1P, 1P+N, 2P, 3P and 4P versions
- IEC rated current I_n : 1...63A
- IEC short-circuit breaking capacity I_{cn} : 10kA (6kA for 1P+N)
- Trip characteristic curve: Type B, C, D
- UL 1077 or UL 489 certified versions.



Page 14-10

MINIATURE CIRCUIT BREAKERS 80...125A

- 1P, 2P, 3P and 4P versions
- IEC rated current I_n : 80...125A
- IEC short-circuit breaking capacity I_{cn} : 10kA
- Trip characteristic curve: Type C, D
- UL 1077 certified versions.



Page 14-11

ADD-ON BLOCKS AND ACCESSORIES

- Auxiliary and indicator contacts
- Undervoltage trip releases
- Shunt trip releases
- Connection accessories.



Page 14-13

SWITCH DISCONNECTORS

- 1P, 2P, 3P and 4P versions
- IEC rated current I_n : 32...125A
- Clear OFF contact status indication
- Auxiliary contact block available.



Page 14-13

RESIDUAL BLOCKS FOR CIRCUIT BREAKERS UP TO 63A

- 2P, 3P and 4P versions
- IEC rated current I_n : 40 and 63A
- Residual current: 30 and 300mA
- Residual current operating characteristic: Type A.



Page 14-14

RESIDUAL CURRENT OPERATED CIRCUIT BREAKERS 25...63A

- 2P and 4P versions
- IEC rated current I_n : 25, 40 and 63A
- IEC rated residual operating current $I_{\Delta n}$: 30mA and 300mA
- Residual current operating characteristic: Type A, B and AC
- Auxiliary contact and signalling contact blocks available.



Page 14-15

RESIDUAL CURRENT OPERATED CIRCUIT BREAKERS WITH OVERCURRENT PROTECTION UP TO 40A

- 1P+N versions
- IEC rated current I_n : 6...40A
- IEC rated short-circuit capacity I_{cn} : 10kA
- Trip characteristic curve: Type C
- Residual current: 30 and 300mA
- Residual current operating characteristic: Type AC and A
- Auxiliary contact and signalling contact blocks available.

1P - 10kA (IEC/EN/BS) 1 module



P1MB1P...



Order code	Curve	IEC In	IEC Icn	N° of DIN module	Qty per pkg	Wt
		[A]	[kA]	n°	n°	[kg]

Single pole, thermal and magnetic trip type, B-curve characteristic.

P1MB1PB01	B	1	10	1	12	0.115
P1MB1PB02	B	2	10	1	12	0.115
P1MB1PB03	B	3	10	1	12	0.115
P1MB1PB04	B	4	10	1	12	0.115
P1MB1PB06	B	6	10	1	12	0.115
P1MB1PB08	B	8	10	1	12	0.115
P1MB1PB10	B	10	10	1	12	0.115
P1MB1PB13	B	13	10	1	12	0.115
P1MB1PB16	B	16	10	1	12	0.115
P1MB1PB20	B	20	10	1	12	0.115
P1MB1PB25	B	25	10	1	12	0.115
P1MB1PB32	B	32	10	1	12	0.115
P1MB1PB40	B	40	10	1	12	0.115
P1MB1PB50	B	50	10	1	12	0.115
P1MB1PB63	B	63	10	1	12	0.115

Single pole, thermal and magnetic trip type, C-curve characteristic.

P1MB1PC01	C	1	10	1	12	0.115
P1MB1PC01V6	C	1.6	10	1	12	0.115
P1MB1PC02	C	2	10	1	12	0.115
P1MB1PC03	C	3	10	1	12	0.115
P1MB1PC04	C	4	10	1	12	0.115
P1MB1PC06	C	6	10	1	12	0.115
P1MB1PC08	C	8	10	1	12	0.115
P1MB1PC10	C	10	10	1	12	0.115
P1MB1PC13	C	13	10	1	12	0.115
P1MB1PC16	C	16	10	1	12	0.115
P1MB1PC20	C	20	10	1	12	0.115
P1MB1PC25	C	25	10	1	12	0.115
P1MB1PC32	C	32	10	1	12	0.115
P1MB1PC40	C	40	10	1	12	0.115
P1MB1PC50	C	50	10	1	12	0.115
P1MB1PC63	C	63	10	1	12	0.115

Single pole, thermal and magnetic trip type, D-curve characteristic.

P1MB1PD01	D	1	10	1	12	0.115
P1MB1PD01V6	D	1.6	10	1	12	0.115
P1MB1PD02	D	2	10	1	12	0.115
P1MB1PD03	D	3	10	1	12	0.115
P1MB1PD04	D	4	10	1	12	0.115
P1MB1PD06	D	6	10	1	12	0.115
P1MB1PD08	D	8	10	1	12	0.115
P1MB1PD10	D	10	10	1	12	0.115
P1MB1PD13	D	13	10	1	12	0.115
P1MB1PD16	D	16	10	1	12	0.115
P1MB1PD20	D	20	10	1	12	0.115
P1MB1PD25	D	25	10	1	12	0.115
P1MB1PD32	D	32	10	1	12	0.115
P1MB1PD40	D	40	10	1	12	0.115
P1MB1PD50	D	50	10	1	12	0.115
P1MB1PD63	D	63	10	1	12	0.115

General characteristics

These devices are used to protect against short circuits and overloads of wiring installations and loads in panel boards, office buildings, stores and similar applications. Their purpose is circuit protection, circuit isolation and load operation controls. They have instantaneous trip characteristics defined as follows:

- B-curve: instantaneous trip 3...5 times In for non-inductive or low inductive loads (heating resistors, generators, very long wire lines)
- C-curve: instantaneous trip 5...10 times In for inductive loads (mixed and inductive resistive loads with low inrush current)
- D-curve: instantaneous trip 10...14 times In for highly inductive loads (loads with high inrush and current such as motors).

Main features include:

- IEC rated current In: 1...63A
- Pole width: 17.5mm / 0.69"
- Contact status with flag indicator
- Trip characteristic: curve type B, C and D
- Auxiliary contacts and trip releases mounted on MCB left side
- Fixing on 35mm DIN rail (IEC/EN/BS 60715).

Operational characteristics

- Dissipation per pole: 3...13W
- IEC rated insulation voltage Ui: 440V
- IEC rated impulse voltage Uimp: 4kV
- IEC rated operational voltage Ue: 230/400VAC
- UL 1077 rated operational voltage: 277VAC
- Short circuit breaking capacity: IEC/EN/BS 10kA - UL 7.5kA 240V - 5kA 277V.

Certifications and compliance

Certifications obtained: cURus (E369585); EAC; TÜV-Rheinland.
Compliant with standards: IEC/EN/BS 60898-1, IEC/EN/BS 60947-2, UL 1077, CSA C22.2 n°235.

1P+N - 6kA 1 module



P1MB1M...

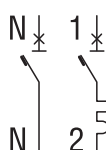

Order code	Curve	IEC In	IEC Icn	N° of DIN module	Qty per pkg	Wt
		[A]	[kA]	n°	n°	[kg]

Single pole + neutral, thermal and magnetic trip type, B-curve characteristic.

P1MB1MB06	B	6	6	1	12	0.115
P1MB1MB10	B	10	6	1	12	0.115
P1MB1MB16	B	16	6	1	12	0.115
P1MB1MB20	B	20	6	1	12	0.115
P1MB1MB25	B	25	6	1	12	0.115
P1MB1MB32	B	32	6	1	12	0.115

Single pole + neutral, thermal and magnetic trip type, C-curve characteristic.

P1MB1MC02	C	2	6	1	12	0.115
P1MB1MC04	C	4	6	1	12	0.115
P1MB1MC06	C	6	6	1	12	0.115
P1MB1MC10	C	10	6	1	12	0.115
P1MB1MC13	C	13	6	1	12	0.115
P1MB1MC16	C	16	6	1	12	0.115
P1MB1MC20	C	20	6	1	12	0.115
P1MB1MC25	C	25	6	1	12	0.115
P1MB1MC32	C	32	6	1	12	0.115
P1MB1MC40	C	40	6	1	12	0.115

General characteristics

These devices are used to protect against short circuits and overloads of wiring installations and loads in panel boards, office buildings, stores and similar applications.

Their purpose is circuit protection, circuit isolation and load operation controls. They have characteristics of instantaneous trip defined as follows:

- B-curve: instantaneous trip 3...5 times I_n for non-inductive or low inductive loads (heating resistors, generators, very long wire lines)
- C-curve: instantaneous trip 5...10 times I_n for inductive loads (mixed loads, resistive and inductive with low inrush current)
- D-curve: instantaneous trip 10...14 times I_n for highly inductive loads (loads with high inrush and current such as motors).

Main features include:

- IEC rated current I_n : 2...40A
- Pole width: 9mm/0.35" (0.5 module)
- Contact status with flag indicator
- Trip characteristic: curve type B and C
- Auxiliary contacts and trip releases mounted on left side
- Fixing on 35mm DIN rail (IEC/EN/BS 60715).

Operational characteristics

- Dissipation per pole: 3...7.5W
- IEC rated insulation voltage U_i : 440V
- IEC rated impulse voltage U_{imp} : 4kV
- IEC rated operational voltage U_e : 230VAC.

Certifications and compliance

Certifications obtained: EAC, TÜV-SUD.
Compliant with standards: IEC/EN/BS 60898-1, IEC/EN/BS 60947-2.

1P+N - 6kA 2 modules



P1MB1N...

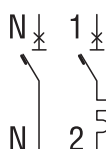

Order code	Curve	IEC In	IEC Icn	N° of DIN module	Qty per pkg	Wt
		[A]	[kA]	no.	n°	[kg]

Single pole + neutral, thermal and magnetic trip type, C-curve characteristic.

P1MB1NC01	C	1	6	2	6	0.190
P1MB1NC02	C	2	6	2	6	0.190
P1MB1NC04	C	4	6	2	6	0.190
P1MB1NC06	C	6	6	2	6	0.190
P1MB1NC10	C	10	6	2	6	0.190
P1MB1NC16	C	16	6	2	6	0.190
P1MB1NC20	C	20	6	2	6	0.190
P1MB1NC25	C	25	6	2	6	0.190
P1MB1NC32	C	32	6	2	6	0.190
P1MB1NC40	C	40	6	2	6	0.190
P1MB1NC50	C	50	6	2	6	0.190
P1MB1NC63	C	63	6	2	6	0.190

General characteristics

- IEC rated current I_n : 1...63A
- Pole width: 17.5mm / 0.69"
- Contact status with flag indicator
- Trip characteristic: curve type C
- Auxiliary contacts and trip releases mounted on left side
- Fixing on 35mm DIN rail (IEC/EN/BS 60715).

Operational characteristics

- Dissipation per pole: 3...13W
- IEC rated insulation voltage U_i : 440V
- IEC rated impulse voltage U_{imp} : 4kV
- IEC rated operational voltage U_e : 230/400VAC.

Certifications and compliance

Certifications obtained: EAC.
Compliant with standards: IEC/EN/BS 60898-1, IEC/EN/BS 60947-2.

2P - 10kA (IEC/EN/BS) 2 modules



P1MB2P...

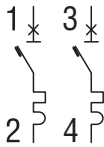

Order code	Curve	IEC In	IEC Icn	N° of DIN module	Qty per pkg	Wt
		[A]	[kA]	n°	n°	[kg]

Two pole, thermal and magnetic trip type, B-curve characteristic.

P1MB2PB01	B	1	10	2	6	0.230
P1MB2PB02	B	2	10	2	6	0.230
P1MB2PB04	B	4	10	2	6	0.230
P1MB2PB06	B	6	10	2	6	0.230
P1MB2PB10	B	10	10	2	6	0.230
P1MB2PB13	B	13	10	2	6	0.230
P1MB2PB16	B	16	10	2	6	0.230
P1MB2PB20	B	20	10	2	6	0.230
P1MB2PB25	B	25	10	2	6	0.230
P1MB2PB32	B	32	10	2	6	0.230
P1MB2PB40	B	40	10	2	6	0.230
P1MB2PB50	B	50	10	2	6	0.230
P1MB2PB63	B	63	10	2	6	0.230

Two pole, thermal and magnetic trip type, C-curve characteristic.

P1MB2PC01	C	1	10	2	6	0.230
P1MB2PC01V6	C	1.6	10	2	6	0.230
P1MB2PC02	C	2	10	2	6	0.230
P1MB2PC03	C	3	10	2	6	0.230
P1MB2PC04	C	4	10	2	6	0.230
P1MB2PC06	C	6	10	2	6	0.230
P1MB2PC08	C	8	10	2	6	0.230
P1MB2PC10	C	10	10	2	6	0.230
P1MB2PC13	C	13	10	2	6	0.230
P1MB2PC16	C	16	10	2	6	0.230
P1MB2PC20	C	20	10	2	6	0.230
P1MB2PC25	C	25	10	2	6	0.230
P1MB2PC32	C	32	10	2	6	0.230
P1MB2PC40	C	40	10	2	6	0.230
P1MB2PC50	C	50	10	2	6	0.230
P1MB2PC63	C	63	10	2	6	0.230

Two pole, thermal and magnetic trip type, D-curve characteristic.

P1MB2PD01	D	1	10	2	6	0.230
P1MB2PD01V6	D	1.6	10	2	6	0.230
P1MB2PD02	D	2	10	2	6	0.230
P1MB2PD03	D	3	10	2	6	0.230
P1MB2PD04	D	4	10	2	6	0.230
P1MB2PD06	D	6	10	2	6	0.230
P1MB2PD08	D	8	10	2	6	0.230
P1MB2PD10	D	10	10	2	6	0.230
P1MB2PD13	D	13	10	2	6	0.230
P1MB2PD16	D	16	10	2	6	0.230
P1MB2PD20	D	20	10	2	6	0.230
P1MB2PD25	D	25	10	2	6	0.230
P1MB2PD32	D	32	10	2	6	0.230
P1MB2PD40	D	40	10	2	6	0.230
P1MB2PD50	D	50	10	2	6	0.230
P1MB2PD63	D	63	10	2	6	0.230

General characteristics

These devices are used to protect against short circuits and overloads of wiring installations and loads in panel boards, office buildings, stores and similar applications.

Their purpose is circuit protection, circuit isolation and load operation controls. They have characteristics of instantaneous trip defined as follows:

- B-curve: instantaneous trip 3...5 times In for non-inductive or low inductive loads (heating resistors, generators, very long wire lines)
- C-curve: instantaneous trip 5...10 times In for inductive loads (mixed loads, resistive and inductive with low inrush current)
- D-curve: instantaneous trip 10...14 times In for highly inductive loads (loads with high inrush and current such as motors).

Main features include:

- IEC rated current In: 1...63A
- Pole width: 17.5mm / 0.69"
- Contact status with flag indicator
- Trip characteristic: curve type B, C and D
- Auxiliary contacts and trip releases mounted on left side
- Fixing on 35mm DIN rail (IEC/EN/BS 60715).

Operational characteristics

- Dissipation per pole: 3...13W
- IEC rated insulation voltage Ui: 440V
- IEC rated impulse voltage Uimp: 4kV
- IEC rated operational voltage Ue: 230/400VAC
- UL 1077 rated operational voltage: 480VAC
- Short circuit breaking capacity: IEC/EN/BS 10kA - UL 7.5kA 480V.

Certifications and compliance

Certifications obtained: cURus (E369585); EAC; TÜV-Rheinland.

Compliant with standards: IEC/EN/BS 60898-1, IEC/EN/BS 60947-2, UL 1077, CSA C22.2 n°235.

3P - 10kA (IEC/EN/BS) 3 modules



P1MB3P...

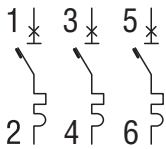

Order code	Curve	IEC In	IEC Icn	N° of DIN module	Qty per pkg	Wt
		[A]	[kA]	n°	n°	[kg]

Three pole, thermal and magnetic trip type, B-curve characteristic.

P1MB3PB01	B	1	10	3	4	0.345
P1MB3PB02	B	2	10	3	4	0.345
P1MB3PB04	B	4	10	3	4	0.345
P1MB3PB06	B	6	10	3	4	0.345
P1MB3PB10	B	10	10	3	4	0.345
P1MB3PB13	B	13	10	3	4	0.345
P1MB3PB16	B	16	10	3	4	0.345
P1MB3PB20	B	20	10	3	4	0.345
P1MB3PB25	B	25	10	3	4	0.345
P1MB3PB32	B	32	10	3	4	0.345
P1MB3PB40	B	40	10	3	4	0.345
P1MB3PB50	B	50	10	3	4	0.345
P1MB3PB63	B	63	10	3	4	0.345

Three pole, thermal and magnetic trip type, C-curve characteristic.

P1MB3PC01	C	1	10	3	4	0.345
P1MB3PC01V6	C	1.6	10	3	4	0.345
P1MB3PC02	C	2	10	3	4	0.345
P1MB3PC03	C	3	10	4	4	0.345
P1MB3PC04	C	4	10	3	4	0.345
P1MB3PC06	C	6	10	3	4	0.345
P1MB3PC08	C	8	10	3	4	0.345
P1MB3PC10	C	10	10	3	4	0.345
P1MB3PC13	C	13	10	3	4	0.345
P1MB3PC16	C	16	10	3	4	0.345
P1MB3PC20	C	20	10	3	4	0.345
P1MB3PC25	C	25	10	3	4	0.345
P1MB3PC32	C	32	10	3	4	0.345
P1MB3PC40	C	40	10	3	4	0.345
P1MB3PC50	C	50	10	3	4	0.345
P1MB3PC63	C	63	10	3	4	0.345

Three pole, thermal and magnetic trip type, D-curve characteristic.

P1MB3PD01	D	1	10	3	4	0.345
P1MB3PD01V6	D	1.6	10	3	4	0.345
P1MB3PD02	D	2	10	3	4	0.345
P1MB3PD03	D	3	10	4	4	0.345
P1MB3PD04	D	4	10	3	4	0.345
P1MB3PD06	D	6	10	3	4	0.345
P1MB3PD08	D	8	10	3	4	0.345
P1MB3PD10	D	10	10	3	4	0.345
P1MB3PD13	D	13	10	3	4	0.345
P1MB3PD16	D	16	10	3	4	0.345
P1MB3PD20	D	20	10	3	4	0.345
P1MB3PD25	D	25	10	3	4	0.345
P1MB3PD32	D	32	10	3	4	0.345
P1MB3PD40	D	40	10	3	4	0.345
P1MB3PD50	D	50	10	3	4	0.345
P1MB3PD63	D	63	10	3	4	0.345

General characteristics

These devices are used to protect against short circuits and overloads of wiring installations and loads in panel boards, office buildings, stores and similar applications. Their purpose is circuit protection, circuit isolation and load operation controls. They have characteristics of instantaneous trip defined as follows:

- B-curve: instantaneous trip 3...5 times I_n for non-inductive or low inductive loads (heating resistors, generators, very long wire lines)
- C-curve: instantaneous trip 5...10 times I_n for inductive loads (mixed loads, resistive and inductive with low inrush current)
- D-curve: instantaneous trip 10...14 times I_n for highly inductive loads (loads with high inrush and current such as motors).

Main features include:

- IEC rated current I_n: 1...63A
- Pole width: 17.5mm / 0.69"
- Contact status with flag indicator
- Trip characteristic: curve type B, C and D
- Auxiliary contacts and trip releases mounted on left side
- Fixing on 35mm DIN rail (IEC/EN/BS 60715).

Operational characteristics

- Dissipation per pole: 3...13W
- IEC rated insulation voltage U_i: 440V
- IEC rated impulse voltage U_{imp}: 4kV
- IEC rated operational voltage U_e: 230/400VAC
- UL 1077 rated operational voltage: 480VAC
- Short circuit breaking capacity: IEC/EN/BS 10kA - UL 7.5kA 480V.

Certifications and compliance

Certifications obtained: cURus (E369585); EAC; TÜV-Rheinland.
Compliant with standards: IEC/EN/BS 60898-1, IEC/EN/BS 60947-2, UL 1077, CSA C22.2 n°235.

4P - 10kA (IEC/EN/BS) 4 modules



P1MB4P..

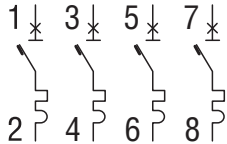

Order code	Curve	IEC In	IEC Icn	N° of DIN module	Qty per pkg	Wt
		[A]	[kA]	n°	n°	[kg]

Four pole, thermal and magnetic trip type, B-curve characteristic.

P1MB4PB01	B	1	10	4	3	0.460
P1MB4PB02	B	2	10	4	3	0.460
P1MB4PB04	B	4	10	4	3	0.460
P1MB4PB06	B	6	10	4	3	0.460
P1MB4PB10	B	10	10	4	3	0.460
P1MB4PB13	B	13	10	4	3	0.460
P1MB4PB16	B	16	10	4	3	0.460
P1MB4PB20	B	20	10	4	3	0.460
P1MB4PB25	B	25	10	4	3	0.460
P1MB4PB32	B	32	10	4	3	0.460
P1MB4PB40	B	40	10	4	3	0.460
P1MB4PB50	B	50	10	4	3	0.460
P1MB4PB63	B	63	10	4	3	0.460

Four pole, thermal and magnetic trip type, C-curve characteristic.

P1MB4PC01	C	1	10	4	3	0.460
P1MB4PC02	C	2	10	4	3	0.460
P1MB4PC04	C	4	10	4	3	0.460
P1MB4PC06	C	6	10	4	3	0.460
P1MB4PC10	C	10	10	4	3	0.460
P1MB4PC13	C	13	10	4	3	0.460
P1MB4PC16	C	16	10	4	3	0.460
P1MB4PC20	C	20	10	4	3	0.460
P1MB4PC25	C	25	10	4	3	0.460
P1MB4PC32	C	32	10	4	3	0.460
P1MB4PC40	C	40	10	4	3	0.460
P1MB4PC50	C	50	10	4	3	0.460
P1MB4PC63	C	63	10	4	3	0.460

Four pole, thermal and magnetic trip type, D-curve characteristic.

P1MB4PD01	D	1	10	4	3	0.460
P1MB4PD02	D	2	10	4	3	0.460
P1MB4PD04	D	4	10	4	3	0.460
P1MB4PD06	D	6	10	4	3	0.460
P1MB4PD10	D	10	10	4	3	0.460
P1MB4PD13	D	13	10	4	3	0.460
P1MB4PD16	D	16	10	4	3	0.460
P1MB4PD20	D	20	10	4	3	0.460
P1MB4PD25	D	25	10	4	3	0.460
P1MB4PD32	D	32	10	4	3	0.460
P1MB4PD40	D	40	10	4	3	0.460
P1MB4PD50	D	50	10	4	3	0.460
P1MB4PD63	D	63	10	4	3	0.460

General characteristics

These devices are used to protect against short circuits and overloads of wiring installations and loads in panel boards, office buildings, stores and similar applications. Their purpose is circuit protection, circuit isolation and load operation controls. They have characteristics of instantaneous trip defined as follows:

- B-curve: instantaneous trip 3...5 times I_n for non-inductive or low inductive loads (heating resistors, generators, very long wire lines)
- C-curve: instantaneous trip 5...10 times I_n for inductive loads (mixed loads, resistive and inductive with low inrush current)
- D-curve: instantaneous trip 10...14 times I_n for highly inductive loads (loads with high inrush and current such as motors).

Main features include:

- IEC rated current I_n: 1...63A
- Pole width: 17.5mm / 0.69"
- Contact status with flag indicator
- Trip characteristic: curve type B, C and D
- Auxiliary contacts and trip releases mounted on left side
- Fixing on 35mm DIN rail (IEC/EN/BS 60715).

Operational characteristics

- Dissipation per pole: 3...13W
- IEC rated insulation voltage U_i: 440V
- IEC rated impulse voltage U_{imp}: 4kV
- IEC rated operational voltage U_e: 230/400VAC
- UL 1077 rated operational voltage: 480VAC
- Short circuit breaking capacity: IEC/EN/BS 10kA - UL 7.5kA 480V.

Certifications and compliance

Certifications obtained: cURus (E369585); EAC; TÜV-Rheinland.
Compliant with standards: IEC/EN/BS 60898-1, IEC/EN/BS 60947-2, UL 1077, CSA C22.2 n°235.

1P - 10kA (IEC/EN/BS) 1 module



P1MB...1P...



Order code	Curve	IEC In	Rat. volt.	N° of DIN mod.	Qty per pkg	Wt
		[A]	[V]	n°	n°	[kg]

One pole, thermal and magnetic trip type, C-curve characteristic.

P1MBUH1PC01	C	1	277	1	12	0.133
P1MBUH1PC01V6	C	1.6	277	1	12	0.133
P1MBUH1PC02	C	2	277	1	12	0.133
P1MBUH1PC03	C	3	277	1	12	0.133
P1MBUH1PC04	C	4	277	1	12	0.133
P1MBUH1PC05	C	5	277	1	12	0.133
P1MBUH1PC06	C	6	277	1	12	0.133
P1MBUH1PC07	C	7	277	1	12	0.133
P1MBUH1PC08	C	8	277	1	12	0.133
P1MBUH1PC10	C	10	277	1	12	0.133
P1MBUH1PC12	C	12	277	1	12	0.133
P1MBUH1PC13	C	13	277	1	12	0.133
P1MBUH1PC15	C	15	277	1	12	0.133
P1MBUH1PC16	C	16	277	1	12	0.133
P1MBUH1PC20	C	20	277	1	12	0.133
P1MBUH1PC25	C	25	277	1	12	0.133
P1MBUH1PC30	C	30	277	1	12	0.133
P1MBUH1PC32	C	32	277	1	12	0.133
P1MBUL1PC35	C	35	120	1	12	0.133
P1MBUL1PC40	C	40	120	1	12	0.133
P1MBUL1PC50	C	50	120	1	12	0.133
P1MBUL1PC60	C	60	120	1	12	0.133
P1MBUL1PC63	C	63	120	1	12	0.133

One pole, thermal and magnetic trip type, D-curve characteristic.

P1MBUH1PD01	D	1	277	1	12	0.133
P1MBUH1PD01V6	D	1.6	277	1	12	0.133
P1MBUH1PD02	D	2	277	1	12	0.133
P1MBUH1PD03	D	3	277	1	12	0.133
P1MBUH1PD04	D	4	277	1	12	0.133
P1MBUH1PD05	D	5	277	1	12	0.133
P1MBUH1PD06	D	6	277	1	12	0.133
P1MBUH1PD07	D	7	277	1	12	0.133
P1MBUH1PD08	D	8	277	1	12	0.133
P1MBUH1PD10	D	10	277	1	12	0.133
P1MBUH1PD12	D	12	277	1	12	0.133
P1MBUH1PD13	D	13	277	1	12	0.133
P1MBUH1PD15	D	15	277	1	12	0.133
P1MBUH1PD16	D	16	277	1	12	0.133
P1MBUH1PD20	D	20	277	1	12	0.133
P1MBUH1PD25	D	25	277	1	12	0.133
P1MBUH1PD30	D	30	277	1	12	0.133
P1MBUH1PD32	D	32	277	1	12	0.133
P1MBUL1PD35	D	35	120	1	12	0.133
P1MBUL1PD40	D	40	120	1	12	0.133
P1MBUL1PD50	D	50	120	1	12	0.133
P1MBUL1PD60	D	60	120	1	12	0.133
P1MBUL1PD63	D	63	120	1	12	0.133

General characteristics

These devices comply with the UL 489 standard, mostly used in the North American markets. They are designed to protect feeder circuits, the part of the system from the network supply point to the protection device for a branch circuit. They can also be used on the international market thanks to compliance with the IEC/EN/BS 60947-2 standard.

They have characteristics of tripping instantaneously defined as follows:

- C-curve: instantaneous trip 5...10 times In for inductive loads (mixed loads, resistive and inductive with low inrush current)
- D-curve: instantaneous trip 10...14 times In for highly inductive loads (loads with high inrush and current such as motors).

Operational characteristics

- Dissipation per pole: 3...13W
- Rated voltage 1...32A: 277V (UL 489)
- Rated voltage 35...63A: 120V (UL 489)
- Rated insulation voltage Ui: 440V (IEC/EN/BS 60947-2)
- Rated impulse voltage Uimp: 4kV (IEC/EN/BS 60947-2)
- Rated operational voltage Ue: 230/400VAC (IEC/EN/BS 60947-2)
- Short circuit breaking capacity: IEC/EN/BS 10kA - UL 10kA.

Certifications and compliance

Certifications obtained: cULus (E481234); EAC. Compliant with standards: UL 489, IEC/EN/BS 60947-2.

2P - 10kA (IEC/EN/BS) 2 modules



P1MB...2P...

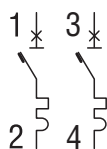

Order code	Curve	IEC In	Rated voltage	N° of DIN mod.	Qty per pkg	Wt
		[A]	[V]	n°	n°	[kg]

Two pole, thermal and magnetic trip type, C-curve characteristic.

P1MBUH2PC01	C	1	480Y/277	2	6	0.255
P1MBUH2PC01V6	C	1.6	480Y/277	2	6	0.255
P1MBUH2PC02	C	2	480Y/277	2	6	0.255
P1MBUH2PC03	C	3	480Y/277	2	6	0.255
P1MBUH2PC04	C	4	480Y/277	2	6	0.255
P1MBUH2PC05	C	5	480Y/277	2	6	0.255
P1MBUH2PC06	C	6	480Y/277	2	6	0.255
P1MBUH2PC07	C	7	480Y/277	2	6	0.255
P1MBUH2PC08	C	8	480Y/277	2	6	0.255
P1MBUH2PC10	C	10	480Y/277	2	6	0.255
P1MBUH2PC12	C	12	480Y/277	2	6	0.255
P1MBUH2PC13	C	13	480Y/277	2	6	0.255
P1MBUH2PC15	C	15	480Y/277	2	6	0.255
P1MBUH2PC16	C	16	480Y/277	2	6	0.255
P1MBUH2PC20	C	20	480Y/277	2	6	0.255
P1MBUH2PC25	C	25	480Y/277	2	6	0.255
P1MBUH2PC30	C	30	480Y/277	2	6	0.255
P1MBUH2PC32	C	32	480Y/277	2	6	0.255
P1MBUL2PC35	C	35	240	2	6	0.255
P1MBUL2PC40	C	40	240	2	6	0.255
P1MBUL2PC50	C	50	240	2	6	0.255
P1MBUL2PC60	C	60	240	2	6	0.255
P1MBUL2PC63	C	63	240	2	6	0.255

Two pole, thermal and magnetic trip type, D-curve characteristic.

P1MBUH2PD01	D	1	480Y/277	2	6	0.255
P1MBUH2PD01V6	D	1.6	480Y/277	2	6	0.255
P1MBUH2PD02	D	2	480Y/277	2	6	0.255
P1MBUH2PD03	D	3	480Y/277	2	6	0.255
P1MBUH2PD04	D	4	480Y/277	2	6	0.255
P1MBUH2PD05	D	5	480Y/277	2	6	0.255
P1MBUH2PD06	D	6	480Y/277	2	6	0.255
P1MBUH2PD07	D	7	480Y/277	2	6	0.255
P1MBUH2PD08	D	8	480Y/277	2	6	0.255
P1MBUH2PD10	D	10	480Y/277	2	6	0.255
P1MBUH2PD12	D	12	480Y/277	2	6	0.255
P1MBUH2PD13	D	13	480Y/277	2	6	0.255
P1MBUH2PD15	D	15	480Y/277	2	6	0.255
P1MBUH2PD16	D	16	480Y/277	2	6	0.255
P1MBUH2PD20	D	20	480Y/277	2	6	0.255
P1MBUH2PD25	D	25	480Y/277	2	6	0.255
P1MBUH2PD30	D	30	480Y/277	2	6	0.255
P1MBUH2PD32	D	32	480Y/277	2	6	0.255
P1MBUL2PD35	D	35	240	2	6	0.255
P1MBUL2PD40	D	40	240	2	6	0.255
P1MBUL2PD50	D	50	240	2	6	0.255
P1MBUL2PD60	D	60	240	2	6	0.255
P1MBUL2PD63	D	63	240	2	6	0.255

General characteristics

These devices comply with the UL 489 standard, mostly used in the North American markets. They are designed to protect feeder circuits, the part of the system from the network supply point to the protection device for a branch circuit. They can in any case be used on the international market thanks to compliance with the IEC/EN/BS 60947-2 standard as well.

They have characteristics of tripping instantaneously defined as follows:

- C-curve: instantaneous trip 5...10 times In for inductive loads (mixed loads, resistive and inductive with low inrush current)
- D-curve: instantaneous trip 10...14 times In for highly inductive loads (loads with high inrush and current such as motors).

Operational characteristics

- Rated voltage 1...32A: 480Y/277V (UL 489)
- Rated voltage 35...63A: 240V (UL 489)
- Rated insulation voltage Ui: 440V (IEC/EN/BS 60947-2)
- Rated impulse voltage Uimp: 4kV (IEC/EN/BS 60947-2)
- Rated operational voltage Ue: 230/400VAC (IEC/EN/BS 60947-2)
- Short circuit breaking capacity: IEC/EN/BS 10kA - UL 10kA.

Certifications and compliance

Certifications obtained: cULus (E481234); EAC.
Compliant with standards: UL 489, IEC/EN/BS 60947-2.

3P - 10kA (IEC/EN/BS) 3 modules



P1MB...3P...

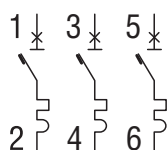

Order code	Curve	IEC In	Rated voltage	N° of DIN mod.	Qty per pkg	Wt
		[A]	[V]	n°	n°	[kg]

Three pole, thermal and magnetic trip type, C-curve characteristic.

P1MBUH3PC01	C	1	480Y/277	3	4	0.388
P1MBUH3PC01V6	C	1.6	480Y/277	3	4	0.388
P1MBUH3PC02	C	2	480Y/277	3	4	0.388
P1MBUH3PC03	C	3	480Y/277	3	4	0.388
P1MBUH3PC04	C	4	480Y/277	3	4	0.388
P1MBUH3PC05	C	5	480Y/277	3	4	0.388
P1MBUH3PC06	C	6	480Y/277	3	4	0.388
P1MBUH3PC07	C	7	480Y/277	3	4	0.388
P1MBUH3PC08	C	8	480Y/277	3	4	0.388
P1MBUH3PC10	C	10	480Y/277	3	4	0.388
P1MBUH3PC12	C	12	480Y/277	3	4	0.388
P1MBUH3PC13	C	13	480Y/277	3	4	0.388
P1MBUH3PC15	C	15	480Y/277	3	4	0.388
P1MBUH3PC16	C	16	480Y/277	3	4	0.388
P1MBUH3PC20	C	20	480Y/277	3	4	0.388
P1MBUH3PC25	C	25	480Y/277	3	4	0.388
P1MBUH3PC30	C	30	480Y/277	3	4	0.388
P1MBUH3PC32	C	32	480Y/277	3	4	0.388
P1MBUL3PC35	C	35	240	3	4	0.388
P1MBUL3PC40	C	40	240	3	4	0.388
P1MBUL3PC50	C	50	240	3	4	0.388
P1MBUL3PC60	C	60	240	3	4	0.388
P1MBUL3PC63	C	63	240	3	4	0.388

Three pole, thermal and magnetic trip type, D-curve characteristic.

P1MBUH3PD01	D	1	480Y/277	3	4	0.388
P1MBUH3PD01V6	D	1.6	480Y/277	3	4	0.388
P1MBUH3PD02	D	2	480Y/277	3	4	0.388
P1MBUH3PD03	D	3	480Y/277	3	4	0.388
P1MBUH3PD04	D	4	480Y/277	3	4	0.388
P1MBUH3PD05	D	5	480Y/277	3	4	0.388
P1MBUH3PD06	D	6	480Y/277	3	4	0.388
P1MBUH3PD07	D	7	480Y/277	3	4	0.388
P1MBUH3PD08	D	8	480Y/277	3	4	0.388
P1MBUH3PD10	D	10	480Y/277	3	4	0.388
P1MBUH3PD12	D	12	480Y/277	3	4	0.388
P1MBUH3PD13	D	13	480Y/277	3	4	0.388
P1MBUH3PD15	D	15	480Y/277	3	4	0.388
P1MBUH3PD16	D	16	480Y/277	3	4	0.388
P1MBUH3PD20	D	20	480Y/277	3	4	0.388
P1MBUH3PD25	D	25	480Y/277	3	4	0.388
P1MBUH3PD30	D	30	480Y/277	3	4	0.388
P1MBUH3PD32	D	32	480Y/277	3	4	0.388
P1MBUL3PD35	D	35	240	3	4	0.388
P1MBUL3PD40	D	40	240	3	4	0.388
P1MBUL3PD50	D	50	240	3	4	0.388
P1MBUL3PD60	D	60	240	3	4	0.388
P1MBUL3PD63	D	63	240	3	4	0.388

General characteristics

These devices comply with the UL 489 standard, mostly used in the North American markets. They are designed to protect feeder circuits, the part of the system from the network supply point to the protection device for a branch circuit. They can also be used on the international market thanks to compliance with the IEC/EN/BS 60947-2 standard.

They have characteristics of tripping instantaneously defined as follows:

- C-curve: instantaneous trip 5...10 times In for inductive loads (mixed loads, resistive and inductive with low inrush current)
- D-curve: instantaneous trip 10...14 times In for highly inductive loads (loads with high inrush and current such as motors).

Operational characteristics

- Rated voltage 1...32A: 480Y/277V (UL 489)
- Rated voltage 35...63A: 240V (UL 489)
- Rated insulation voltage Ui: 440V (IEC/EN/BS 60947-2)
- Rated impulse voltage Uimp: 4kV (IEC/EN/BS 60947-2)
- Rated operational voltage Ue: 230/400VAC (IEC/EN/BS 60947-2)
- Short circuit breaking capacity: IEC/EN/BS 10kA - UL 10kA.

Certifications and compliance

Certifications obtained: cULus (E481234); EAC. Compliant with standards: UL 489, IEC/EN/BS 60947-2.

1P, 2P, 3P and 4P - 10kA (IEC/EN/BS)



P2MB1P...

1



2



P2MB2P...

1 3

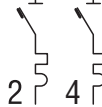

2 4



P2MB3P...

1 3 5

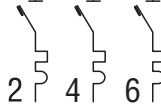

2 4 6



P2MB4P...

1 3 5 7

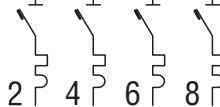

2 4 6 8

Order code	Curve	IEC In	IEC Icn	N° of DIN module	Qty per pkg	Wt
		[A]	[kA]	no.	no.	[kg]

One pole, thermal and magnetic trip type, C-curve characteristic.

P2MB1PC080	C	80	10	1.5	9	0.166
P2MB1PC100	C	100	10	1.5	9	0.166
P2MB1PC125	C	125	10	1.5	9	0.166

Two pole, thermal and magnetic trip type, C-curve characteristic.

P2MB2PC080	C	80	10	3	4	0.340
P2MB2PC100	C	100	10	3	4	0.340
P2MB2PC125	C	125	10	3	4	0.340

Three pole, thermal and magnetic trip type, C-curve characteristic.

P2MB3PC080	C	80	10	4.5	3	0.510
P2MB3PC100	C	100	10	4.5	3	0.510
P2MB3PC125	C	125	10	4.5	3	0.510

Four pole, thermal and magnetic trip type, C-curve characteristic.

P2MB4PC080	C	80	10	6	2	0.680
P2MB4PC100	C	100	10	6	2	0.680
P2MB4PC125	C	125	10	6	2	0.680

Three pole, thermal and magnetic trip type, D-curve characteristic.

P2MB3PD080	D	80	10	4.5	3	0.510
P2MB3PD100	D	100	10	4.5	3	0.510
P2MB3PD125	D	125	10	4.5	3	0.510

Four pole, thermal and magnetic trip type, D-curve characteristic.

P2MB4PD080	D	80	10	6	2	0.510
P2MB4PD100	D	100	10	6	2	0.510
P2MB4PD125	D	125	10	6	2	0.510

① Icn at 230V.

General characteristics

These devices are used to protect against short circuits and overloads of wiring installations and loads in panel boards, office buildings, stores and similar applications.

Their purpose is circuit protection, circuit isolation and load operation controls. They have characteristics of instantaneous trip defined as follows:

- C-curve: instantaneous trip 5...10 times In for inductive loads (mixed loads, resistive and inductive with low inrush current)
- D-curve: instantaneous trip 10...14 times In for highly inductive loads (loads with high inrush and current such as motors).

Main features include:

- IEC rated current In: 80...125A
- Pole width: 27mm / 1.06"
- Contact status with flag indicator
- Trip characteristic: curve type C and D
- Fixing on 35mm DIN rail (IEC/EN/BS 60715).

Operational characteristics

- Dissipation per pole: 15...20W
- IEC rated insulation voltage Ui: 400V
- IEC rated impulse voltage Uimp: 4kV
- IEC rated operational voltage Ue: 230/400VAC (230VAC 1P version)
- Short circuit breaking capacity: IEC/EN/BS 10kA - UL 5kA 240V (1P) - 5kA 480V (2-3-4P).

Certifications and compliance

Certifications obtained: cURus (E369585); EAC; TÜV-Rheinland.

Compliant with standards: IEC/EN/BS 60898-1, IEC/EN/BS 60947-2, UL 1077, CSA C22.2 n°235.

Add-on blocks for miniature circuit breakers 1...63A



P1X1011



P1X16230

Order code	Description	Qty per MCB	Qty per pkg	Wt
		n°	n°	[kg]
Auxiliary contact.				
P1X1011	1 changeover contact for P1MB...	1	12	0.040
P1X1011UH	1 changeover contact for P1MBU...	1	12	0.040
Indicator contact for thermal-magnetic trip.				
P1X1311	1 changeover contact	1	12	0.040
Undervoltage trip release.				
P1X14230	230V 50/60Hz	1	8	0.070
Shunt trip release.				
P1X16230	110...415V 50/60Hz	1	8	0.070

❶ Not suitable for P1MBU...

General characteristics

- Auxiliary and indicator contact width: 9mm/0.35" (0.5 module)
- Undervoltage and shunt trip release width: 18mm/0.71" (1 module)
- Maximum combination: 3 add-on blocks on MCB left side only of which 1 undervoltage or shunt release directly on MCB side and then 2 contacts of which 1 auxiliary and 1 indicator.

Operational characteristics

- IEC rated impulse voltage Uimp: 4kV
- IEC rated operational current in AC: 6A 230V; 3A 400V (auxiliary contacts).

Certifications and compliance

Certifications obtained: EAC, cURus (excluding P1X14230), UL (only P1X14230)
Compliant with standards: IEC/EN/BS 60947-5-1, CSA C22.2 n° 5.

Add-on blocks for miniature circuit breakers 80...125A



P2X1311



P2X16230

Order code	Description	Qty per MCB	Qty per pkg	Wt
		n°	n°	[kg]
Auxiliary contact.				
P2X1011	1 changeover contact	1	10	0.040
Indicator contact for thermal-magnetic trip.				
P2X1311	1 changeover contact	1	10	0.040
Shunt trip release.				
P2X16230	110...415V 50/60Hz	1	8	0.070

General characteristics

- Auxiliary and indicator contact width: 9mm/0.35" (0.5 module)
- Shunt trip release width: 17.5mm/0.69" (1 module)
- Maximum combination: 3 add-on blocks on MCB sides of which 1 undervoltage or shunt release on MCB right side and 2 contacts on the left of which 1 auxiliary and 1 indicator.

Operational characteristics

- IEC rated insulation voltage Ui: 500V
- Rated impulse voltage Uimp: 4kV
- Rated operational current in AC: 6A 230V; 3A 400V (auxiliary contacts).

Certifications and compliance

Certifications obtained: EAC.
Compliant with standards: IEC/EN/BS 60947-5-1.

Accessories for miniature circuit breakers

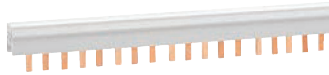

P1X9033



P1X9133



P1X9201

P1X9210

P1X9202



P1X1810

P2X1810

① Suitable for P1MB...
Not suitable for P1MBU...

Order code	Description	Qty per pkg	Wt [kg]
		n°	[kg]
P1X9031①	Single-pole supply busbar	10	0.160
P1X9032①	Two-pole supply busbar	10	0.320
P1X9033①	Three-pole supply busbar	10	0.474
P1X9034①	Four-pole supply busbar	10	0.600
P1X9130①	Kit of 5 isolating covers for unused busbar terminals	10	0.030
P1X9131①	End cap for P1X9031	50	0.001
P1X9132①	End cap for P1X9032	50	0.001
P1X9133①	End cap for P1X9033	50	0.001
P1X9134①	End cap for P1X9034	50	0.001
P1X9201①	Single-pole terminal for busbar supply; conductor cross section 25mm ² max.	25	0.010
P1X9210①	1-pole terminal for supplying busbar; conductor cross section 25mm ² max.; left entry	25	0.010
P1X9202①	Single-pole terminal for busbar supply; conductor cross section 50mm ² max.	25	0.022
P1X1810	Padlockable attachment for breaker control lever P1MB...	10	0.001
P2X1810	Padlockable attachment for breaker control lever P2MB...	10	0.002

General and operational characteristics

SINGLE-POLE SUPPLY BUSBAR

- Rated operational voltage Ue: 1000V
- Central point of power supply: 100A max.
- Side point of power supply: 63A max.
- Spacing: 17.8mm/0.70"
- Busbar section: 10mm²
- For paralleling connection
- For 57 modules, 1000mm/39.37" long (57 1P breakers).

TWO-POLE, THREE-POLE AND FOUR-POLE SUPPLY BUSBARS

- Rated operational voltage Ue: 690V
- Central point of power supply: 100A max.
- Side point of power supply: 63A max.
- Spacing: 17.8mm/0.70"
- Busbar section: 10mm²
- For paralleling connection
- Two-pole: for 56 modules, 1000mm/39.37" long (28 2P breakers)
- Three-pole: for 57 modules, 1012mm/39.84" long (19 3P breakers)
- Four-pole: for 56 modules, 1000mm/39.37" long (14 4P breakers).

PADLOCKABLE ATTACHMENT

- Max. padlock diameter 5mm/0.20"
- Padlockable in ON and OFF
- One can be fitted for each pole of the breaker.

UL approved supply busbar



3P18L57S0U50



802150S



802180



ULC...



BRU3V



802307

Order code	Description	Qty per pkg	Wt [kg]
		n°	[kg]
Power bars for UL 1077 thermal-magnetic circuit breakers, type P1MB...			
1P18K57S0U50	Single-pole supply busbar	10	0.160
2P18L56S0U50	Two-pole supply busbar	10	0.320
3P18L57S0U50	Three-pole supply busbar	10	0.474
BRB5W	Kit of 5 insulating caps for unused bar terminals	10	0.030
A69	End cap for 1P18K57S0U50	50	0.001
A7	End cap for 2P18L56S0U50 and 3P18L57S0U50	50	0.001
802150S	Single-pole terminal block to supply busbar 1P18K57S0U50; conductor section 10 to 1 AWG	25	0.030
802180	Single-pole terminal block to supply busbar 2P18L56S0U50 and 3P18L57S0U50; conductor section 10 to 1 AWG	10	0.030
Power bars for UL 489 thermal-magnetic circuit breakers, type P1MBU...			
ULC157A18A	Single pole power bar	10	0.160
ULC256A18A	Two pole power bar	10	0.320
ULC357A18A	Three pole power bar	10	0.474
BRU3V	Kit of 3 insulating caps for unused bar terminals	10	0.022
A68	End cap for all ULC... type bars	50	0.001
802307	Single-pole terminal block to power bars; conductor section 14 to 2 AWG	10	0.030

Main features

UL approved power bars are divided into two groups:

- Bars for UL 1077 approved thermal-magnetic circuit breakers;
- Bars for UL 489 approved thermal-magnetic circuit breaker bars.

Both models are supplied 1000mm/39.37" long and can be cut to the desired length. This feature makes it easy to adapt to any combination of installed thermal-magnetic circuit breakers. Special end caps must be applied at the points where the bars are cut, to ensure IP20 protection and to comply with UL standards.

Operational characteristics

POWER BARS FOR UL APPROVED THERMAL-MAGNETIC CIRCUIT BREAKERS

- Maximum rated AC voltage: 600V
- Central power point: 160A max
- Side point for power supply: 80A max
- Spacing: 17.8mm/0.70"
- Bar section: 18mm²
- For parallel connection
- Single pole: for 57 modules, 1000mm/39.37" long (57 1P switches)
- Two pole: for 56 modules, 1000mm/39.37" long (28 2P switches)
- Three pole: for 57 modules, 1012mm/39.84" long (19 3P switches).

Certifications

UL 508 for P18K57... bars (for use with UL 1077 approved thermal-magnetic circuit breakers).
UL 489 for UL... bars (for use with UL 489 approved thermal-magnetic circuit breakers).

14 Miniature and residual circuit breakers

Switch disconnectors.
Residual blocks

Switch disconnectors



P1MS1P...



P1MS2P...



P1MS3P...



P1MS4P...

new

Order code	Ie [A]	N° of DIN module	Qty per pkg	Wt [kg]
Modular switch disconnectors - 1P.				
P1MS1P032	32	1	12	0.083
P1MS1P040	40	1	12	0.083
P1MS1P063	63	1	12	0.083
P1MS1P100	100	1	12	0.083
P1MS1P125	125	1	12	0.083
Modular switch disconnectors - 2P.				
P1MS2P032	32	2	6	0.170
P1MS2P040	40	2	6	0.170
P1MS2P063	63	2	6	0.170
P1MS2P100	100	2	6	0.170
P1MS2P125	125	2	6	0.170
Modular switch disconnectors - 3P.				
P1MS3P032	32	3	4	0.250
P1MS3P040	40	3	4	0.250
P1MS3P063	63	3	4	0.250
P1MS3P100	100	3	4	0.250
P1MS3P125	125	3	4	0.250
Modular switch disconnectors - 4P.				
P1MS4P032	32	4	3	0.330
P1MS4P040	40	4	3	0.330
P1MS4P063	63	4	3	0.330
P1MS4P100	100	4	3	0.330
P1MS4P125	125	4	3	0.330

General characteristics

These devices are mainly used for disconnection and insulation of power lines and systems. They can also be used to switch various types of resistive and inductive loads.

Main features include:

- IEC rated current I_n: 32...125A
- Pole width: 17.5mm / 0.69"
- Clear contact status indication
- Wide terminals for easy wiring
- Auxiliary contacts can be mounted on left side and padlockable attachment
- Fixing on 35mm DIN rail (IEC/EN/BS 60715).

Operational characteristics

- Utilisation category: AC-22A
- IEC rated insulation voltage U_i: 1000V
- IEC rated impulse voltage U_{imp}: 4kV
- IEC rated operational voltage U_e: 1P 230...240V; 2P, 3P, 4P 400...440V
- IEC rated short-time withstand current I_{cw}: 12xI_e (for 1 second).

Certifications and compliance

Certifications obtained: TÜV-Rheinland, EAC.
Compliant with standards: IEC/EN/BS 60947-3.

Add-on blocks for switch disconnectors P1MS...



P1X1011S



P1X1810

Order code	Description	Qty per breaker	Qty per pkg	Wt [kg]
		n°	n°	[kg]
P1X1011S	Auxiliary contact, 1 changeover contact	1	1	0.040
P1X1810	Padlockable attachment for breaker control lever P1MS...	1	10	0.001

Operational characteristics (auxiliary contact)

- Utilisation category AC-12: 6A 230V; 3A 400V
- Utilisation category DC-12: 0.4A 250V; 6A 24V.

Residual blocks



P1RA2P...



P1RA3P...

Order code	Type	IEC In [A]	IEC IΔn [mA]	N° of DIN module	Qty per pkg	Wt [kg]
Residual blocks - 2P - type A.						
P1RA2P40A030	A	40	30	2	1	0.160
P1RA2P40A300	A	40	300	2	1	0.160
P1RA2P63A030	A	63	30	2	1	0.160
P1RA2P63A300	A	63	300	2	1	0.160
Residual blocks - 3P - type A.						
P1RA3P40A030	A	40	30	3.5	1	0.205
P1RA3P40A300	A	40	300	3.5	1	0.205
P1RA3P63A030	A	63	30	3.5	1	0.205
P1RA3P63A300	A	63	300	3.5	1	0.205
Residual blocks - 4P - type A.						
P1RA4P40A030	A	40	30	3.5	1	0.230
P1RA4P40A300	A	40	300	3.5	1	0.230
P1RA4P63A030	A	63	30	3.5	1	0.230
P1RA4P63A300	A	63	300	3.5	1	0.230

General characteristics

These devices are intended for the protection of people against indirect contact (electric shock) and of installations against fire hazards due to a persistent earth/ground fault current.

They snap onto the P1MB... series thermal-magnetic circuit breakers; this combination forms a single device to protect people, protect against fire and protect lines.

Operational characteristics

- IEC rated insulation voltage U_i: 400V
- IEC rated impulse voltage U_{imp}: 4kV
- IEC rated frequency: 50/60Hz
- IEC rated operational voltage U_e: 230/400V
- IEC rated residual current for tripping IΔn: 30mA; 300mA
- Dissipation per pole: 1.6W (40A), 2.7W (63A).

Certifications and compliance

Compliance with standards: IEC/EN/BS 61009-1.
Certifications obtained: TÜV-SUD, EAC.

2P - 2 modules
4P - 4 modules



P1RD2P...

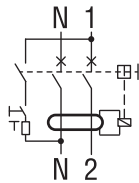

P1RD4P...

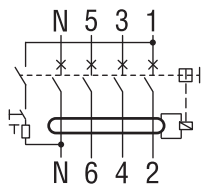

P1RC4PB...

Add-on blocks for P1RD...



P1X1011

P1X16230

Order code	Type	IEC In	IEC IΔn	N° of DIN module	Qty per pkg	Wt
		[A]	[mA]	n°	n°	[kg]

Two pole RCCB type AC.						
P1RD2P25AC030	AC	25	30	2	1	0.185
P1RD2P25AC300	AC	25	300	2	1	0.185
P1RD2P40AC030	AC	40	30	2	1	0.185
P1RD2P40AC300	AC	40	300	2	1	0.185
P1RD2P63AC030	AC	63	30	2	1	0.185
P1RD2P63AC300	AC	63	300	2	1	0.185

Two pole RCCB type A.						
P1RD2P25A030	A	25	30	2	1	0.185
P1RD2P25A300	A	25	300	2	1	0.185
P1RD2P40A030	A	40	30	2	1	0.185
P1RD2P40A300	A	40	300	2	1	0.185
P1RD2P63A030	A	63	30	2	1	0.185
P1RD2P63A300	A	63	300	2	1	0.185

new

Four pole RCCB type AC.						
P1RD4P25AC030	AC	25	30	4	1	0.326
P1RD4P25AC300	AC	25	300	4	1	0.326
P1RD4P40AC030	AC	40	30	4	1	0.326
P1RD4P40AC300	AC	40	300	4	1	0.326
P1RD4P63AC030	AC	63	30	4	1	0.326
P1RD4P63AC300	AC	63	300	4	1	0.326

Four pole RCCB type A.						
P1RD4P25A030	A	25	30	4	1	0.326
P1RD4P25A300	A	25	300	4	1	0.326
P1RD4P40A030	A	40	30	4	1	0.326
P1RD4P40A300	A	40	300	4	1	0.326
P1RD4P63A030	A	63	30	4	1	0.326
P1RD4P63A300	A	63	300	4	1	0.326

Four pole RCCB type B.						
P1RC4P40B030	B	40	30	4	1	0.335
P1RC4P40B300	B	40	300	4	1	0.335
P1RC4P63B030	B	63	30	4	1	0.335
P1RC4P63B300	B	63	300	4	1	0.335
P1RC4P80B030	B	80	30	4	1	0.335
P1RC4P80B300	B	80	300	4	1	0.335

General characteristics

These RCCBs are intended for the protection of people against indirect contact (electric shock) and of installations against fire hazards due to a persistent earth/ground fault current. Specifically to prevent electric shock, RCCBs must be rated with a rated residual current (IΔn) not exceeding 30mA so that these devices trip in the case of earth/ground fault only. They usually are connected in series with thermal-magnetic breakers which assure short circuit and overcurrent protection too. P1RC types have a IΔn of either 30mA or 300mA and are available with three different versions of residual current tripping, as follows:

Type AC – Tripping for earth/ground fault is ensured “for residual sinusoidal alternating currents, suddenly applied or slowly rising”. The symbol identifying Type AC is the following:

Type A – Tripping for earth/ground fault is ensured “for residual sinusoidal alternating currents and pulsating direct currents, suddenly applied or slowly rising”. In addition to the protection given by Type AC, this version protects against residual current with pulsating waveform. This can be caused by circuits connected with electronic equipment. The symbol identifying Type A is the following:

Type B – tripping is ensured for all conditions already covered by types AC and A. They also ensure tripping for high-frequency leakage currents up to 1000Hz and direct currents. They are particularly suitable for applications with inverters, UPSs and electric vehicle charging stations. The symbol identifying Type B is the following:

Main features include:

- IEC rated current In: 25A, 40A and 63A
- Versions: 2P and 4P
- Type of operation: AC, A and B
- Pole width: 17.5mm / 0.69"
- Contact status with flag indicator
- Fixing on 35mm DIN rail (IEC/EN/BS 60715).

Operational characteristics

- Dissipation per pole:
 - 1.1W for P1RC2/4P25... type AC or A
 - 2.9W for P1RC2/4P40... type AC, A or B
 - 7.2W for P1RC2/4P63... type AC, A or B
 - 9.7W for P1RC/4P80... type B
- IEC rated insulation voltage Ui: 400V
- IEC rated impulse voltage Uimp: 4kV
- IEC rated frequency: 50/60Hz
- IEC rated operational voltage Uc: 230VAC for 2P; 230/400VAC for 4P
- IEC rated residual operating voltage Ue: IΔn: 30mA; 300mA
- IEC short-circuit breaking capacity Icn: 10kA

Certifications and compliance

Certifications obtained: TÜV-Rheinland (types AC and A), EAC. Compliant with standards: IEC/EN/BS 61008-1, IEC/EN/BS 61008-2-1 (all types); IEC/EN/BS 62423 (type B).

General characteristics

- Auxiliary and indicator contact width: 9mm/0.35" (0.5 module)
- Undervoltage and shunt trip release width: 18mm/0.71" (1 module)
- Maximum combination: 3 add-on blocks on MCB left side only of which 1 undervoltage or shunt release directly on MCB side and then 2 contacts of which 1 auxiliary and 1 indicator.

Operational characteristics

- IEC rated impulse voltage Uimp: 4kV
- IEC rated operational current in AC: 6A 230V; 3A 400V (auxiliary contacts).

Certifications and compliance

Certifications obtained: EAC, cURus (excluding P1X14230), UL (only P1X14230). Compliant with standards: IEC/EN/BS 60947-5-1, CSA C22.2 n° 5.

Order code	Description	Qty per MCB	Qty per pkg	Wt
		n°	n°	[kg]

Auxiliary contact.				
P1X1011	1 changeover contact	1	12	0.040
Indicator contact for trip.				
P1X1311	1 changeover contact	1	12	0.040
Undervoltage trip release.				
P1X14230	230V 50/60Hz	1	8	0.070
Shunt trip release.				
P1X16230	110...415V 50/60Hz	1	8	0.070
Padlockable attachment				
P1X1810	Padlockable attachment for breaker control lever	1	10	0.001

14 Miniature and residual circuit breakers

Residual current operated circuit breakers with overcurrent protection

1P+N - 10kA 2 modules



P1RE1N...

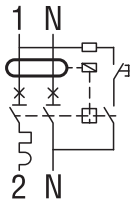

new

Order code	Curve	IEC In	IEC Icn	IEC IΔn	Mod. DIN	Qty per pkg	Wt
		[A]	[kA]	[mA]	n°	n°	[kg]

Single pole + neutral RCBO type AC.

P1RE1NC06AC030	C	6	10	30	2	1	0.205
P1RE1NC06AC300	C	6	10	300	2	1	0.205
P1RE1NC10AC030	C	10	10	30	2	1	0.205
P1RE1NC10AC300	C	10	10	300	2	1	0.205
P1RE1NC16AC030	C	16	10	30	2	1	0.205
P1RE1NC16AC300	C	16	10	300	2	1	0.205
P1RE1NC20AC030	C	20	10	30	2	1	0.205
P1RE1NC20AC300	C	20	10	300	2	1	0.205
P1RE1NC25AC030	C	25	10	30	2	1	0.205
P1RE1NC25AC300	C	25	10	300	2	1	0.205
P1RE1NC32AC030	C	32	10	30	2	1	0.205
P1RE1NC32AC300	C	32	10	300	2	1	0.205
P1RE1NC40AC030	C	40	10	30	2	1	0.205
P1RE1NC40AC300	C	40	10	300	2	1	0.205

Single pole + neutral RCBO type A.

P1RE1NC06A030	C	6	10	30	2	1	0.205
P1RE1NC06A300	C	6	10	300	2	1	0.205
P1RE1NC10A030	C	10	10	30	2	1	0.205
P1RE1NC10A300	C	10	10	300	2	1	0.205
P1RE1NC13A030	C	13	10	30	2	1	0.205
P1RE1NC16A030	C	16	10	30	2	1	0.205
P1RE1NC16A300	C	16	10	300	2	1	0.205
P1RE1NC20A030	C	20	10	30	2	1	0.205
P1RE1NC20A300	C	20	10	300	2	1	0.205
P1RE1NC25A030	C	25	10	30	2	1	0.205
P1RE1NC25A300	C	25	10	300	2	1	0.205
P1RE1NC32A030	C	32	10	30	2	1	0.205
P1RE1NC32A300	C	32	10	300	2	1	0.205
P1RE1NC40A030	C	40	10	30	2	1	0.205
P1RE1NC40A300	C	40	10	300	2	1	0.205

General characteristics

These devices both detect and trip in the event of residual current and protect circuits in the case of short circuits and overcurrent. From a practical point of view, they integrate both functions of MCB and RCCB.

They have a C-type trip characteristic (instantaneous trip 5-10 times I_n) and are used for inductive loads (mixed loads, resistive and inductive with low inrush current).

In addition, they have a rated residual current (I_{Δn}) of either 30mA or 300mA and are available with two different versions of residual current tripping type AC or A as described on page 14-14.

Its main features are:

- IEC rated current I_n: 6...40A
- Version: 1P+N
- Contact status with flag indicator
- Double control lever to distinguish the residual current tripping from short circuit or overcurrent tripping
- Trip characteristic: curve type C
- Fixing on 35mm DIN rail (IEC/EN/BS 60715).

Operational characteristics

- Dissipation per pole: 3...13W
- Rated insulation voltage U_i: 400V
- Rated impulse voltage U_{imp}: 4kV
- Operating frequency: 50/60Hz
- Rated operational voltage U_e: 230VAC
- Rated residual operating voltage I_{Δn}: 30mA; 300mA
- IEC short-circuit breaking capacity I_{cn}: 10kA

Certifications and compliance

Certifications obtained: TÜV Rheinland, EAC. Compliant with standards: IEC/EN/BS 61009-1, IEC/EN/BS 61009-2-1.

Add-on blocks for P1RE...



P1X1011



P1X16230

Order code	Description	Qty per MCB	Qty per pkg	Wt
		n°	n°	[kg]

Auxiliary contact.

P1X1011	1 changeover contact	1	12	0.040
---------	----------------------	---	----	-------

Indicator contact for thermal-magnetic trip.

P1X1311	1 changeover contact	1	12	0.040
---------	----------------------	---	----	-------

Undervoltage trip release.

P1X14230	230V 50/60Hz	1	8	0.070
----------	--------------	---	---	-------

Shunt trip release.

P1X16230	110...415V 50/60Hz	1	8	0.070
----------	--------------------	---	---	-------

Padlockable attachment

P1X1810	Padlockable attachment for breaker control lever	1	10	0.001
---------	--	---	----	-------

General characteristics

- Auxiliary and indicator contact width: 9mm/0.35" (0.5 module)
- Undervoltage and shunt trip release width: 18mm/0.71" (1 module)
- Maximum combination: 3 add-on blocks on MCB left side only of which 1 undervoltage or shunt release directly on MCB side and then 2 contacts of which 1 auxiliary and 1 indicator.

Operational characteristics

- IEC rated impulse voltage U_{imp}: 4kV
- IEC rated operational current in AC: 6A 230V; 3A 400V (auxiliary contacts).

Certifications and compliance

Certifications obtained: EAC, cURus (excluding P1X14230), UL (only P1X14230) Compliant with standards: IEC/EN/BS 60947-5-1, CSA C22.2 n° 5.

14 Miniature and residual circuit breakers

Dimensions [mm (in)]

MINIATURE CIRCUIT BREAKERS

P1MB...

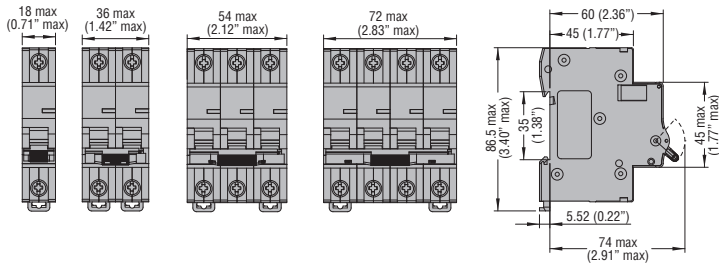

ACCESSORIES

Add-on contacts

P1X1011 - P1X0111S - P1X1011UH - P1X1311

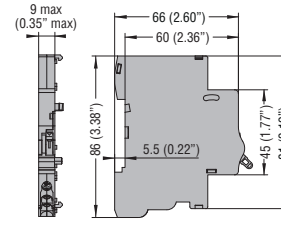

Undervoltage and shunt releases

P1X14230 - P1X16230

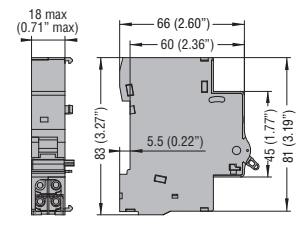

P1MBUH... - P1MBUL...

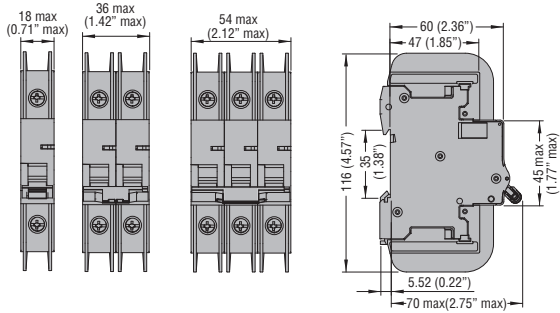

SWITCH DISCONNECTORS

P1MS...

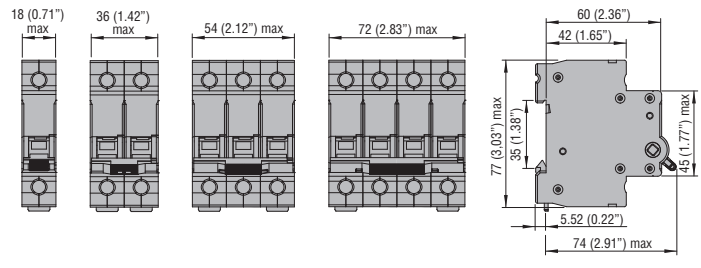

MINIATURE CIRCUIT BREAKERS

P2MB...

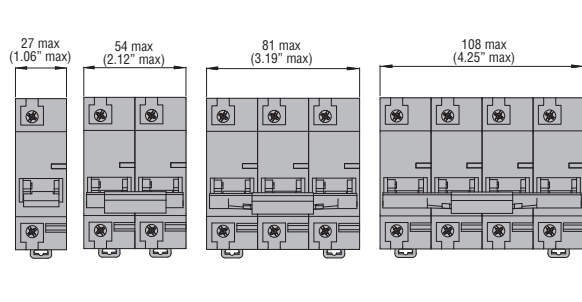

ACCESSORIES

Add-on contacts

P2X1011 - P2X1311

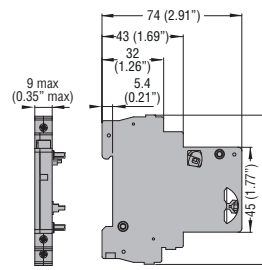

Shunt release

P2X16230

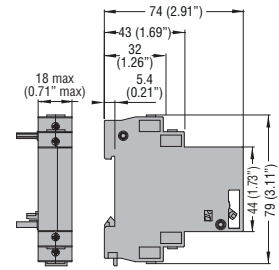

RESIDUAL BLOCKS

P1RA

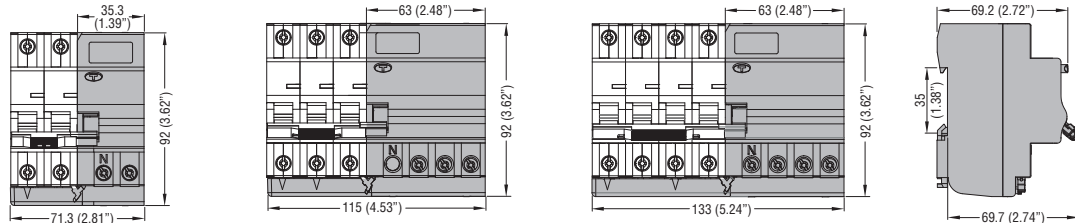

RESIDUAL CURRENT OPERATED CIRCUIT BREAKERS

P1RD...

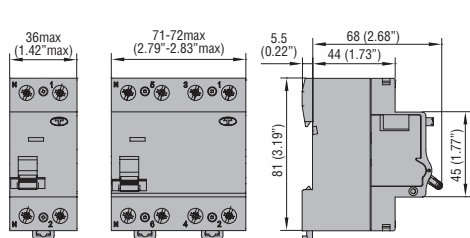

RESIDUAL CURRENT OPERATED CIRCUIT BREAKERS WITH OVERCURRENT PROTECTION

P1RE...

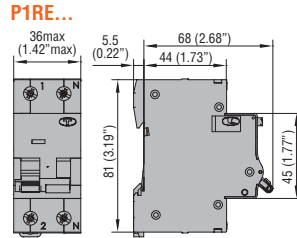

Wiring diagrams

P1X1011 - P1X1011S - P1X1011UH - P2X1011

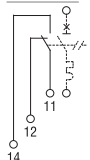

P1X1311 - P2X1311

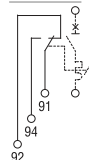

P1X14230

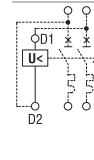

P1X16230 - P2X16230

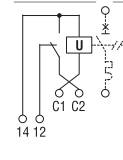

TYPE		P1MB1M...	P1MB1N...	P1MB...P...	P2MB	P1MS...	P1RA	P1RD...	P1RE...	
Description		Miniature circuit breakers	Miniature circuit breakers	Miniature circuit breakers	Miniature circuit breakers	Switch disconnectors	Residual blocks	Residual current operated circuit breakers	Residual current operated circuit breakers w/ overcurrent prot.	
Standards		IEC/EN/BS 60898, IEC/EN/BS 60947-2	IEC/EN/BS 60898, IEC/EN/BS 60947-2	IEC/EN/BS 60898, IEC/EN/BS 60947-2 UL 1077 - UL 489 ^①	IEC/EN/BS 60947-2 UL 1077	IEC/EN/BS 60947-3	IEC/EN/BS 61008-1 IEC/EN/BS 61008-2-1	IEC/EN/BS 61008-1 IEC/EN/BS 61008-2-1	IEC/EN/BS 61009-2-1	
IEC rated insulation voltage U_i	V	500	230	1000	400	1000	400	400	400	
IEC rated impulse withstand voltage U_{imp}	kV	4	4	4	6	4	4	4	4	
IEC rated operational voltage U_e	in AC	V	230	230	230 (1P, 1P+N) 230/400 (2P, 3P, 4P) ^②	230 (1P) 230/400 (2P, 3P, 4P)	230 (2P) 230/400 (3P, 4P)	230 (2P) 230/400(4P)	230	
	in DC	V	—	—	80 (1P, 2P) ^④	80(1P)/125(2P) ^⑤	—	—	—	
Rated frequency	Hz	50/60	50/60	50/60	50/60	50/60	50/60	50/60	50/60	
Maximum rated current	A	40	63	63	125	125	63	63	40	
Available rated current for types	A	2, 4, 6, 10, 13, 16, 20, 25, 32, 40	1, 2, 4, 6, 10, 16, 20, 25, 32, 40, 50, 63	1, 1.6, 3, 4, 6, 8, 10, 13, 16, 20, 25, 32, 40, 50, 63 ^②	80, 100, 125	30, 40, 63, 100, 125	40, 63	25, 40, 63 (80A B type only)	6, 10, 16, 20, 25, 32, 40	
Versions		1P+N	1P+N	1P, 2P, 3P, 4P	1P, 2P, 3P, 4P	1P, 2P, 3P, 4P	2P, 3P, 4P	2P, 4P	1P+N	
Tripping characteristic	curve	B-C	C	B-C-D	C-D	—	—	—	C	
Instantaneous tripping		Curve B: 3...5In Curve C: 5...10In	Curve B: 3...5In Curve C: 5...10In	Curve B: 3...5In Curve C: 5...10In Curve D: 10...14In	Curve C: 5...10In Curve D: 10...14In	—	—	—	Curve C: 5...10In	
Residual operation characteristic	type	—	—	—	—	—	A	AC, A, B	AC, A	
Rated residual current $I_{\Delta n}$	mA	—	—	—	—	—	30, 300	30, 300	30, 300	
Short circuit capacity (IEC/EN/BS)	kA	6 (Icn/Icu)	6 (Icn/Icu)	10 (Icn/Icu)	10 (Icu)	—	—	10 (Inc)	10 (Icn)	
Short circuit capacity (UL 1077) ^③	kA	—	—	7.5 (1P 240V) 5 (1P 277V) 7.5 (2,3,4P 480V)	5	—	—	—	—	
Mechanical life	cycle	20,000	20,000	20,000	10,000	7,000	20,000	20,000	20,000	
Electrical life	cycle	10,000	10,000	10,000	10,000	1,000	10,000	10,000	10,000	
Tightening torque of terminals	Nm	1.1...1.2	1.8...2	1.8...2	3.2...3.5	3.2...3.5	1.8...2	1.8...2	1.8...2	
	lb.in	9.7...10.6	16...17.7	16...17.7	28.8...31	28.8...31	16...17.7	16...17.7	16...17.7	
	Tool	PZ2	PzZ2	PZ2	PZ2	PZ2	PZ2	PZ2	PZ2	
Conductor section min...max.	mm ²	1...16	1...35	1...35	2.5...50	1...50	1...25	2.5...35	1...16	
	AWG	14...6	14...2	14...2	14...1/0	16...1	14...6	14...2	16...3	
AMBIENT CONDITIONS										
Temperature	Operating	°C	-40...+70	-40...+70	-40...+70	-40...+70	-25...+70	-25...+60	-25...+60	-25...+60
	Storage	°C	-40...+80	-40...+80	-40...+80	-40...+80	-25...+70	-40...+80	-40...+80	-40...+80
Max. altitude	m	2,000	2,000	2,000	2,000	2,000	2,000	2,000	2,000	
Pollution degree		2	2	2	3	3	2	2	2	
Mounting		35mm DIN rail (IEC/EN/BS 60715)								

TRIP CHARACTERISTICS

Curve B

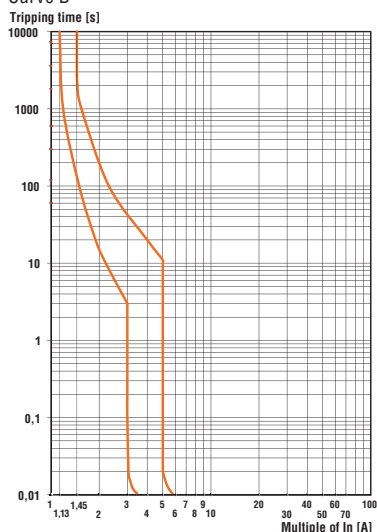

Curve C

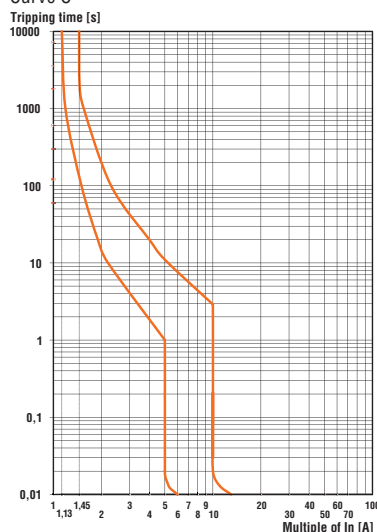

Curve D

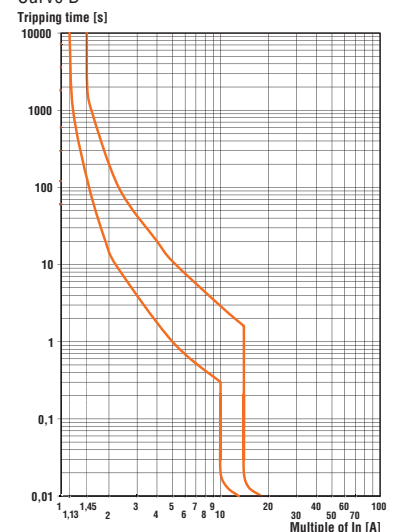

① UL489 only P1MBU... version; for the operational voltages for these devices refer to the pages for the chosen product.
 ② For the UL 489, P1MBU... versions, the following rated current currents are also available: 5, 7, 12, 15, 30, 35, 60 A.

③ For the UL 489, P1MBU... versions to 32A: 1P 277V; 2P and 3P 480V/277V. From 35 to 63A: 1P 120V; 2P and 3P 240V.
 ④ UL 1077 standard: 60VDC (1P) / 125VDC (2P), short circuit capacity 7.5kA.
 For the UL 489, P1MBU... versions: 60VDC (1P, 2P) / 125VDC (2P), short circuit capacity 10kA
 ⑤ UL 1077 standard: 60VDC (1P, 2P), short circuit capacity 10kA.
 ⑥ For the UL 489, P1MBU..., short circuit capacity 10kA.



- Protection against overvoltage and high surge conditions caused by direct or indirect lightning strikes
- Types with plug-in cartridge provide fast servicing capability
- Mechanical indicator for visual failure status signalling of single modules
- Versions with or without output for remote SPD status indication
- Versions for data and signal lines
- Versions for photovoltaic applications.

Surge protection devices (SPD)

	SEC. - PAGE
Type 1 and 2 monoblock $I_{imp}=25kA$	15 - 4
Type 1 and 2 with plug-in cartridge $I_{imp}=12.5kA$	15 - 4
Type 1 and 2 monoblock $I_{imp}=12.5kA$	15 - 4
Type 2 with plug-in cartridge $I_n=20kA$	15 - 5
Type 2 with plug-in cartridge $I_n=5kA$	15 - 5
Type 3 with plug-in cartridge $U_{oc}/I_{cw}=10kV/5kA$	15 - 6
Type 3 compact versions $U_{oc}/I_{cw}=6kV/3kA$	15 - 6
Type C2-D1 for data and signal lines $I_n=10kA$	15 - 6
Type 1 and 2 for photovoltaic applications $U_{cpv}=1100VDC$	15 - 7
Type 2 for photovoltaic applications $U_{cpv}=600VDC, 1100VDC$ and $1500VDC$	15 - 7

Dimensions	15 - 8
Wiring diagrams	15 - 9
Technical characteristics	15 - 11



Pag. 15-4

SURGE PROTECTION DEVICES TYPE 1 AND 2 MONOBLOCK VERSIONS $I_{imp}=25kA$

- 1P, 1P+N, 2P, 3P, 3P+N, 4P
- IEC impulse current I_{imp} (10/350 μ s): 25kA
- IEC maximum discharge current I_{max} (8/20 μ s): 100kA
- SPD status indicator
- Version with output for remote status indication.



Pag. 15-4

SURGE PROTECTION DEVICES TYPE 1 AND 2 VERSIONS WITH PLUG-IN CARTRIDGE $I_{imp}=12.5kA$

- 1P, 1P+N, 2P, 3P, 3P+N, 4P
- IEC impulse current I_{imp} (10/350 μ s): 12.5kA
- IEC maximum discharge current I_{max} (8/20 μ s): 60kA
- IEC combined surge U_{oc}/I_{sc} (1.2/50, 8/20 μ s): 10kV/5kA
- Single module status indicator
- Version with output for remote status indication.



Pag. 15-4

SURGE PROTECTION DEVICES TYPE 1 AND 2 MONOBLOCK VERSIONS $I_{imp}=12.5kA$

- 1P, 1P+N, 2P, 3P, 3P+N, 4P
- IEC impulse current I_{imp} (10/350 μ s): 12.5kA
- IEC maximum discharge current I_{max} (8/20 μ s): 50kA
- SPD status indicator
- Version with output for remote status indication.



Pag. 15-5

SURGE PROTECTION DEVICES TYPE 2 VERSIONS WITH PLUG-IN CARTRIDGE $I_n=20kA$

- 1P, 1P+N, 2P, 3P, 3P+N, 4P
- IEC maximum discharge current I_{max} (8/20 μ s): 50kA
- IEC rated discharge current I_n (8/20 μ s): 20kA
- Single module status indicator
- Versions with and without output for remote status indication.



Pag. 15-5

SURGE PROTECTION DEVICES TYPE 2 VERSIONS WITH PLUG-IN CARTRIDGE $I_n=5kA$

- 1P, 1P+N, 2P, 3P, 3P+N, 4P
- IEC maximum discharge current I_{max} (8/20 μ s): 15kA
- IEC rated discharge current I_n (8/20 μ s): 5kA
- Single module status indicator
- Versions with and without output for remote status indication.



Pag. 15-6

SURGE PROTECTION DEVICES TYPE 3 VERSIONS WITH PLUG-IN CARTRIDGE $U_{oc}/I_{cw}=10kV/5kA$

- 1P+N
- Version with plug-in cartridge
 - IEC rated current I_n (8/20 μ s): 5kA
 - Combined impulse U_{oc} : 10kV
 - SPD status indicator
 - Output for remote status indication
- Acoustic or optical intervention indicator.

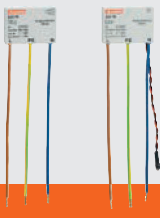

Pag. 15-6

SURGE PROTECTION DEVICES TYPE 3 COMPACT VERSIONS $U_{oc}/I_{cw}=6kV/3kA$

- 1P+N
- Compact version
 - IEC rated current I_n (8/20 μ s): 3kA
 - Combined impulse U_{oc} : 6kA
- Acoustic or optical intervention indicator.



Pag. 15-6

SURGE PROTECTION DEVICES TYPE C2-D1 FOR DATA AND SIGNAL LINES $I_n=10kA$

- Version for line RS485
 - Rated voltage U_n : 5VDC
 - C2 Rated current I_n (8/20 μ s): 10kA
 - D1 Impulse current I_{imp} (10/350 μ s): 2.5kA
 - Output for remote status indication
- Version for Ethernet line Cat.6 - POE
 - Rated voltage U_n : 48VDC
- C2 Rated current I_n (8/20 μ s) L-PE: 10kA
- D1 Impulse current I_{imp} (10/350 μ s): 1kA.



Page 15-7

SURGE PROTECTION DEVICES TYPE 1 AND 2 AND TYPE 2 FOR PHOTOVOLTAIC APPLICATIONS

- Versions with plug-in cartridge: +, -, PE
- IEC maximum operational voltage: 1500VDC
- IEC maximum discharge current I_{max} (8/20 μ s): 40kA
- IEC rated discharge current I_n (8/20 μ s): 20kA
- Single module status indicator
- Versions with or without output for remote status indication
- Tested according to EN/BS 50539-11.

SAFE INSTALLATIONS!

	Type 1, 2		Type 2	Type 3
LPZ protection zones	0 _A 0 _B	1	2	3
Installation category	IV	III	II	I
Impulse withstand voltage of equipment	6kV	4kV	2.5kV	1.5kV

SURGE PROTECTION DEVICES

The surge arresters commonly defined as SPDs (Surge Protection Devices), are devices designed to protect electric systems and equipment against transient and impulse overvoltages such as those caused by lightning strikes and by electric switching. Their function is to divert the discharge or impulse current generated by an overvoltage to earth/ground, thereby protecting the equipment downstream. SPDs are installed in parallel with the electric line to be protected. At the mains rated voltage, they are comparable to an open circuit and have a high impedance at their ends. In the presence of an overvoltage, this impedance falls to very low values, closing the circuit to earth/ground. Once the overvoltage has ended, their impedance rises again rapidly to the initial value (very high), returning to open loop conditions. The SA1B and SA0B (monoblock) type protects against direct and indirect lightning strikes as well as induced overvoltage conditions. It can be installed in areas with a high risk of direct lightning strikes, inside main distribution boards or nearby sub-distribution boards. With the SA0 plug-in cartridge type, the same features are available with the advantage of only having to replace the protection cartridge once the SPD blows.

PROTECTION ZONES

Standards define the LPZs (Lightning Protection Zones), which indicate the different zones at risk. These are distinguished among:

LPZ 0A: Area outside a building not protected by LPS (e.g. lightning rods) where a direct lightning strike is possible. In this zone, there is total exposure to induced electromagnetic fields.

LPZ 0B: Area outside a building protected by LPS; therefore, a direct lightning strike is not possible. In this zone, there is total exposure to induced electromagnetic fields.

LPZ 1: Area inside a building so protected against direct lightning strikes. In this zone, there is the possibility of very high overvoltages and of induced electromagnetic fields which may be attenuated depending on the degree of screening. This zone must be protected by an SPD type 1 at the boundary with zone LPZ 0A or 0B.

LPZ 2: Area inside a building (e.g. in a room), in which there is the possibility of low overvoltages since they are limited by SPDs installed upstream. This zone must be protected by an SPD type 2 at the boundary with zone LPZ 1.

LPZ 3: Area inside a building (e.g. the system connected to a socket in a room) characterised by very sensitive equipment, in which there is the possibility of very low overvoltages as they are limited by SPDs installed upstream. This zone must be protected by an SPD type 3 at the boundary with zone LPZ 2.

INSTALLATION CATEGORY

For the correct choice of the SPD, the dielectric strength of the equipment to protect needs to be considered. This level is established by IEC 60664-1 standard.

For a 230/400V installation, it specifies:

Installation category IV: 6kV for devices installed upstream of the distribution board (for example, delivery point with the distribution system)

Installation category III: 4kV for devices being part of the fixed system (for example, distribution boards, switching devices, isolators, ducting and their accessories)

Installation category II: 2.5kV for non electronic devices (for example, household appliances or electric tools)

Installation category I: 1.5kV for equipment containing "particularly sensitive" electronic circuits (for example, electronic devices like PCs or TVs).

RECOMMENDATIONS FOR INSTALLATION

For correct installation, it is advisable to make connections between the line and the SPD input (phase or neutral terminals) as well as between the SPD output (earth/ground terminal) and the equipotential bonding connection with a maximum 0.5m/20" length of the leads. To reduce the distance, use of the so-called "V connection" is admissible.

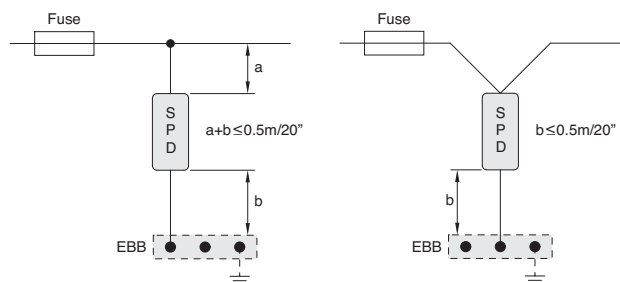

For more details, IEC/EN/BS 62305 standards can be consulted.

Type 2 DC

Industrial buildings

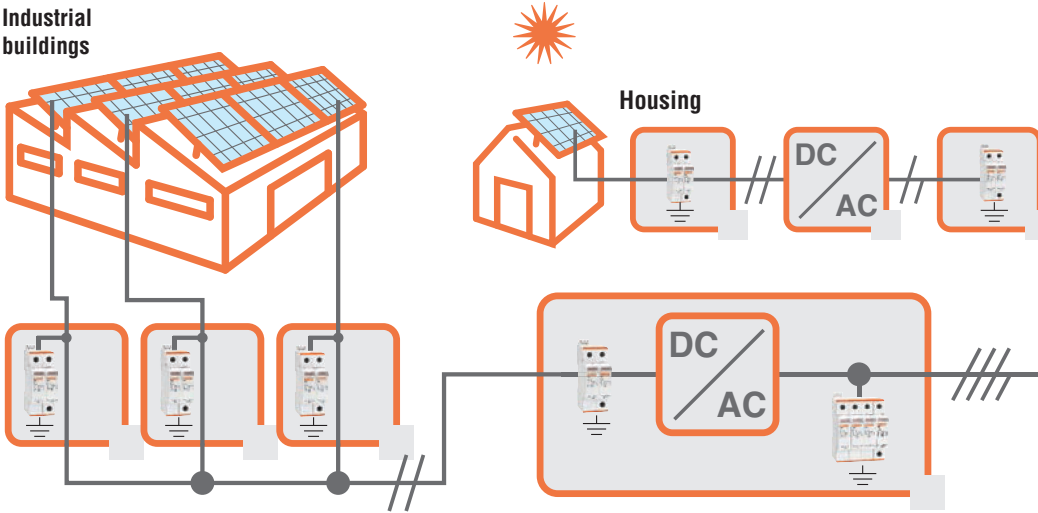

SURGE PROTECTION DEVICES FOR PHOTOVOLTAIC APPLICATIONS

In photovoltaic applications in a domestic environment or industrial facility or other similar circumstances, equipped with lightning rod systems having a safety distance (S), SPD type 2, suitable for DC duty, can be used to protect the installation. It is advisable to install these devices as close as possible to the photovoltaic panels, consequently in the so-called string boards. If the AC/DC inverter is far away from the string boards (indicatively more than 10m/33' apart), another SPD type 2 DC needs to be installed next to the inverter on the DC side. Installation of SPD type 2 suitable of AC duty is also required downstream of the inverter on the AC side. For more details, consult specific national standards and/or application guides issued by local authorities for solar systems concerning protection against lightning. The SG2DG... types with plug-in cartridges are suitable for connection in the DC side of a solar installation and offer protection against induced overvoltage conditions. The SG2...A300 type is suitable for installation downstream of the inverter on the AC side and in intermediate panels.

BACKUP PROTECTION

Protection against short circuits of SPDs is provided by overcurrent devices (gL/gG fuses), which should be chosen according to the SPD manufacturer's recommendations.

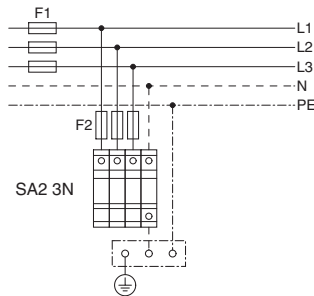

Fuse size depends on SPD

SPD COORDINATION

In order to obtain an effective protection against overvoltage, it is advisable to install several SPDs coordinated with one another in cascade connection. For instance, it is advisable to have a type 1 SPD in the main distribution board, a Type 2 SPD in the sub-distribution board and a type 3 SPD near the terminal equipment to be protected. In this way, the energy originating from an overvoltage gradually decreases as it reaches the equipment to protect.

DEFINITIONS AND RATINGS ACCORDING TO IEC/EN/BS

Maximum continuous voltage U_c :

Maximum value of AC or DC voltage that the SPD is capable of permanently withstanding without activating or getting damaged; this is its rated voltage.

Protection level voltage U_p :

Maximum value of the voltage between the terminals of the SPD in presence of an impulsive overvoltage. It is a fundamental parameter to correctly choose the SPD; it must be taken into account with regards to the impulse voltage of the equipment to protect.

Impulse current I_{imp} :

Crest value of the current that circulates in the SPD with a 10/350 μ s waveform (activation must be guaranteed for 20 times without damage). It is used to classify SPDs in test class I.

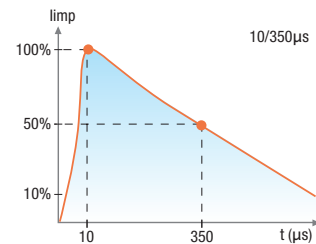

Rated discharge current I_n :

Crest value of the current that circulates in the SPD with an 8/20 μ s waveform (activation must be guaranteed for 20 times without damage). It is used to classify SPDs in test class II.

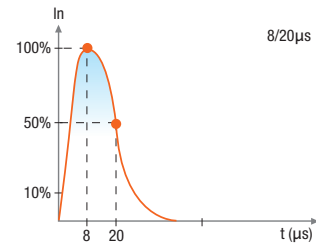

Open circuit discharge voltage U_{oc} :

Crest value of the no-load discharge voltage delivered by the test generation with a 1.2/50 μ s waveform simultaneously with a short circuit current of an 8/20 μ s waveform, applied at the SPD terminals. It is used to classify SPDs in test class III.

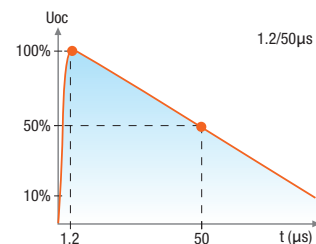

Monoblock Iimp=25kA



SA1B1PA320R

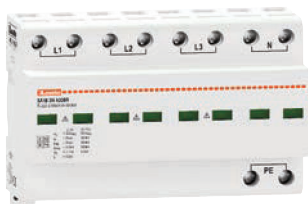

SA1B3NA320R

Order code	Pole arrangement	Relay output	Number of DIN modules	Qty per pkg	Wt
		(SPDT)		n°	[kg]

MONOBLOCK VERSION.
IEC impulse current Iimp (10/350µs) 25kA per pole.

SA1B1PA320R	1P	YES	2	1	0.275
SA1B1NA320R	1P+N	YES	4	1	0.390
SA1B2PA320R	2P	YES	4	1	0.395
SA1B3PA320R	3P	YES	6	1	0.595
SA1B3NA320R	3P+N	YES	8	1	0.760
SA1B4PA320R	4P	YES	8	1	0.780

Main characteristics

The surge protection device type SA1B combines the performance of SPD type 1 and 2 into a single product. It protects against direct and indirect lightning strikes as well as induced overvoltage conditions. It can be installed in areas with a high risk of direct lightning strikes, inside main distribution boards or nearby sub-distribution boards.

Operational characteristics

- IEC maximum continuous operating voltage U_c: 320VAC
- IEC maximum discharge current I_{max} (8/20µs): 100kA per pole
- IEC rated discharge current I_n (8/20µs): 25kA per pole
- Version with relay output having changeover contact for remote status indication
- IEC degree of protection: IP20.

Certifications and compliance

Certification obtained: EAC.
Compliant with standards: IEC/EN/BS 61643-11.

Characteristics

Type	IEC rated voltage U _n [V]	IEC voltage protection level U _p [kV] L-N	Power installation system
SA1B1PA320R	230	<1.4	TN-C, TN-S, TT ^①
SA1B1NA320R	230	<1.4/1.3	TT, TN-S
SA1B2PA320R	230	<1.4	TN-S
SA1B3PA320R	230/400	<1.4	TN-C
SA1B3NA320R	230/400	<1.4/1.5	TT, TN-S
SA1B4PA320R	230/400	<1.4	TN-S

① Between L-N only.

With plug-in cartridge Iimp=12.5kA



SA01PA320R



SA02PA320R



SAX00PA320

Order code	Pole arrangement	Relay output	Number of DIN modules	Qty per pkg	Wt
		(SPDT)		n°	[kg]

VERSION WITH PLUG-IN CARTRIDGE.
IEC impulse current Iimp (10/350µs) 12.5kA per pole.

SA01PA320R	1P	YES	1	1	0.195
SA01NA320R	1P+N	YES	2	1	0.365
SA02PA320R	2P	YES	2	1	0.370
SA03PA320R	3P	YES	3	1	0.540
SA03NA320R	3P+N	YES	4	1	0.670
SA04PA320R	4P	YES	4	1	0.670

PLUG-IN CARTRIDGE.

Order code	Description	Qty per pkg	Wt
		n°	[kg]
SAX00PA320	For SA0... type	1	0.100

Main characteristics

SURGE PROTECTION DEVICES TYPE SA0
It has a plug-in cartridge and combines the performance of SPD type 1 and 2 into a single product. It is ideal in all those systems of reduced extent to protect the load side downstream of main circuit breaker to terminal equipment. It protects against direct and indirect lightning strikes as well as induced overvoltage conditions. It can be installed inside main distribution boards and nearby terminal equipment. The protection cartridges are plug-in and can be easily replaced for quick servicing.

SURGE PROTECTION DEVICES TYPE SA0B

Monoblock version SPD, it combines the performance of SPD type 1 and 2 into a single product. It is ideal in all those systems of reduced extent to protect the load side downstream of main circuit breaker to terminal equipment. It protects against direct and indirect lightning strikes as well as induced overvoltage conditions. It can be installed inside main distribution boards and nearby terminal equipment. The protection cartridges are plug-in and can be easily replaced for quick servicing.

Operational characteristics

- IEC maximum continuous operating voltage U_c: 320VAC
- IEC maximum discharge current I_{max} (8/20µs) per pole: 60kA (SA0...); 50kA (SA0B...)
- IEC rated discharge current I_n (8/20µs): 25kA per pole (SA0...); 20kA (SA0B...)
- Versions with or without relay output having changeover contact for remote status indication
- IEC degree of protection: IP20.

Certifications and compliance

Certification obtained: EAC.
Compliant with standards: IEC/EN/BS 61643-11.

Characteristics

Type	IEC rated voltage U _n [V]	IEC voltage protection level U _p [kV] L-N	Power installation system
SA0...1PA...	230	<1.5	TN-C, TN-S, TT ^①
SA0...1NA...	230	<1.5	TT, TN-S
SA0...2PA...	230	<1.5	TN-S
SA0...3PA...	230/400	<1.5	TN-C
SA0...3NA...	230/400	<1.5	TT, TN-S
SA0...4PA...	230/400	<1.5	TN-S

① Between L-N only.

Monoblock Iimp=12.5kA



SA0B1PA320R

Order code	Pole arrangement	Relay output	Number of DIN modules	Qty per pkg	Wt
		(SPDT)		n°	[kg]

MONOBLOCK VERSION.
IEC impulse current Iimp (10/350µs) 12.5kA per pole.

SA0B1PA320R	1P	YES	2	1	0.205
SA0B1NA320R	1P+N	YES	2	1	0.155
SA0B2PA320R	2P	YES	2	1	0.230
SA0B3PA320R	3P	YES	3	1	0.330
SA0B3NA320R	3P+N	YES	4	1	0.600
SA0B4PA320R	4P	YES	4	1	0.600

With plug-in cartridge In=20kA



SG2...

Order code	Pole arrangement	Relay output	Number of DIN modules	Qty per pkg	Wt
				n°	[kg]

VERSION WITH PLUG-IN CARTRIDGES.
Rated discharge current In (8/20µs) 20kA per pole.

SG21PA300	1P	NO	1	1	0.128
SG21PA300R	1P	YES	1	1	0.135
SG21NA300	1P+N	NO	2	1	0.234
SG21NA300R	1P+N	YES	2	1	0.240
SG22PA300	2P	NO	2	1	0.252
SG22PA300R	2P	YES	2	1	0.266
SG23PA300	3P	NO	3	1	0.366
SG23PA300R	3P	YES	3	1	0.376
SG23NA300	3P+N	NO	4	1	0.477
SG23NA300R	3P+N	YES	4	1	0.486
SG24PA300	4P	NO	4	1	0.496
SG24PA300R	4P	YES	4	1	0.505

PLUG-IN CARTRIDGE.

Order code	Description	Qty per pkg	Wt
		n°	[kg]
SGX02PA300	For SG2...A300/300R types	1	0.100

In=5kA



SG2C...

Order code	Pole arrangement	Relay output	Number of DIN modules	Qty per pkg	Wt
		(SPDT)		n°	[kg]

VERSION WITH PLUG-IN CARTRIDGES.
Rated discharge current In (8/20µs) 5kA per pole.

SG2C1NA320	1P+N	NO	1	1	0.126
SG2C2PA320	2P	NO	1	1	0.144

Main characteristics

SURGE PROTECTION DEVICES TYPE SG2

They are available in plug-in cartridge version and they are suitable for installation in secondary boards and in terminal equipment.

They ensure protection against overvoltages conditions. The protection cartridges are plug-in and can be easily replaced for quick servicing.

SG2 surge arresters are immune to temporary overvoltages (TOV) and block the circulation of the subsequent network current after the intervention.

SURGE PROTECTION DEVICES TYPE SG2C

They are available in plug-in cartridge version and suitable for installation in residential boards where a 5kA per pole indirect discharge protection is sufficient. They have compact size, 1 module width for two poles.

Operational characteristics

- IEC maximum continuous operating voltage Uc: 300VAC (SG2...)/320VAC (SG2C...)
- IEC maximum discharge current I_{max} (8/20µs): 50kA per pole (SG2...); 15kA (SG2C...)
- IEC rated discharge current In (8/20µs): 20kA per pole (SG2...); 5kA (SG2C...)
- Versions with or without relay output having changeover contact for remote status indication (SG2...)
- IEC degree of protection: IP20.

Certifications and compliance

Certification obtained: EAC.

Compliant with standards: IEC/EN/BS 61643-11.

Characteristics

Type	IEC rated voltage Un [V]	IEC voltage protection level Up [kV] L-N	Power installation system
SG21PA...	230	<1,5	TN-C, TN-S, TT ¹
SG2/SG2C1NA...	230	<1,5	TT, TN-S
SG2/SG2C2PA...	230	<1,5	TN-S
SG23PA...	230/400	<1,5	TN-C
SG23NA...	230/400	<1,5	TT, TN-S
SG24PA...	230/400	<1,5	TN-S

¹ Between L-N only.

Type 3 with plug-in cartridge

Uoc/lcw = 10kV/5kA



SA31NA320R

Order code	Pole arrangement	Relay output	Number of DIN modules	Qty per pkg	Wt
		(SPDT)		n°	[kg]

VERSION WITH PLUG-IN CARTRIDGES.
Combined impulse Uoc/lcw (1.2/50µs, 8/20µs) 10kV/5kA.

SA31NA320R	1P+N	YES	1	1	0.140
-------------------	------	-----	---	---	-------

General characteristics

SURGE PROTECTION DEVICE TYPE SA3
They are available in pluggable cartridge version for installation on DIN rail or compact version for installation in terminal block or electrical conduit. They are used for protection of end users (electronic devices). The DIN rail version includes a relay output with exchange contact for status reporting. The compact versions are available with acoustic or light signaling and are provided with pre-wired connectors, length 11cm.

Operational characteristics

- IEC nominal voltage Un: 230VAC
- IEC rated current In (8 / 20µs): 5kA (SA3...A320R), 3kA (SA3...MS, SA3...ML)
- IEC combined impulse Uoc: 10kV (SA3...A320R), 6kV (SA3...MS, SA3...ML)
- IEC Protection level Up <1.5kV
- IEC degree of protection: IP20.

Certifications and compliance

Certification obtained: EAC.
Compliant with standards: IEC/EN/BS 61643-11.

Type 3 compact version

Uoc/lcw = 6kV/3kA



SA31NA275MS

SA31NA275ML

Order code	Pole arrangement	Intervention signaling	Qty per pkg	Wt
			n°	[kg]

COMPACT VERSION.
Combined impulse Uoc/lcw (1.2/50µs, 8/20µs) 6kV/3kA.

SA31NA275MS	1P+N	Acoustic	1	0.050
SA31NA275ML	1P+N	Optical	1	0.050

Type C2-D1 for data and signal lines

In = 10kA



SASD5VR

SASDET6

Order code	Application	Relay output	Qty per pkg	Wt
			n°	[kg]

MONOBLOCK VERSION.
Rated current C2 In (8/20 µs): 10kA.

SASD5VR	RS485	YES	1	0.058
SASDET6	Ethernet Cat.6 - POE	-	1	0.120

General characteristics

Surge protection device for data lines type RS485 (5VDC) and Ethernet Cat. 6 Power Over Ethernet (POE). Typically used for protection of televisions, data lines, PCs, video cameras, electronic control units, measuring devices, switches and routers.

Operational characteristics

- TYPE SASD 5VR
- IEC rated voltage Un: 5VDC
 - C2 rated current In (8 / 20µs): 10kA
 - D1 impulse current Iimp (10 / 350µs): 2.5kA
 - IEC degree of protection: IP20.

TYPE SASD ET6

- IEC rated voltage Un: 48VDC (POE)
- C2 rated current In (8 / 20µs) L-PE: 10kA
- D1 Iimp impulsive current (10 / 350µs): 1kA
- IEC degree of protection: IP20.

Certifications and compliance

Certification obtained: EAC.
Compliant with standards: IEC/EN/BS 61643-11.

15 Surge protection devices

Type 1 and 2 for photovoltaic application.
Type 2 for photovoltaic application

Type 1 and 2 with plug-in cartridge



SG2EDGK10M3R

new

Order code	Pole arrangement	Relay output	Number of DIN modules	Qty per pkg	Wt
		(SPDT)		n°	[kg]

EN rated voltage Un 1100VDC.

SG2EDGK10M3R	+, -, PE	YES	3	1	0.406
---------------------	----------	-----	---	---	-------

Type 2 with plug-in cartridge



SG2DG600M2...

new

Order code	Pole arrangement	Relay output	Number of DIN modules	Qty per pkg	Wt
		(SPDT)		n°	[kg]

EN rated voltage Un 600VDC.

SG2DG600M2	+, -, PE	NO	2	1	0.320
SG2DG600M2R	+, -, PE	YES	2	1	0.325

new

EN rated voltage Un 1100VDC.

SG2DGK10M3	+, -, PE	NO	3	1	0.396
SG2DGK10M3R	+, -, PE	YES	3	1	0.406
SA2EDGK10M3	+, -, PE	YES	3	1	0.406

EN rated voltage Un 1500VDC.

SG2DGK50M3	+, -, PE	NO	3	1	0.444
-------------------	----------	----	---	---	-------



SG2DGK10M3R

Plug-in cartridges



SGX02DG600M2

new

Order code	Description	Qty per pkg	Wt
		n°	[kg]

SGX02DG600M2	For SG2DG600M2/M2R type	1	0.100
SGX02DGK10M3	For SG2DGK10M3/M3R type	1	0.100
SGX02DGK50M3	For SG2DGK50M3 type	1	0.100

Main characteristics

The surge protection device type SG2EDG..., SG2DG... and SA2EDG... with plug-in cartridge for photovoltaic applications is suitable for installation on the direct-current end of a photovoltaic installation and protects against induced overvoltage conditions.

The protection cartridges are plug-in and can be easily replaced for quick servicing.

Operational characteristics

- EN maximum continuous voltage Ucpv: 600VDC, 1100VDC, 1500VDC
- EN short circuit current rating Iscpv: 11kA for SG2EDG... and SG2DG..., 9kA per SA2EDG...
- Versions with or without relay output having changeover contact for remote status indication
- EN degree of protection: IP20.

Characteristics

Type	EN rated voltage Un [VDC]	EN continuous voltage Ucpv [VDC]	EN voltage protection level Up [kV]
SG2DG600M2	600	600	<1.9
SG2DG600M2R	600	600	<1.9
SG2DGK10M3	1100	1100	<3.8
SG2DGK10M3R	1100	1100	<3.8
SG2EDGK10M3R	1100	1100	<3.8
SA2EDGK10M3	1100	1100	<4.0
SG2DGK50M3	1500	1500	<5.0

Certifications and compliance

Certification obtained: EAC.
Compliant with standards: IEC/EN/BS 50539-11.

SA1B...A320R

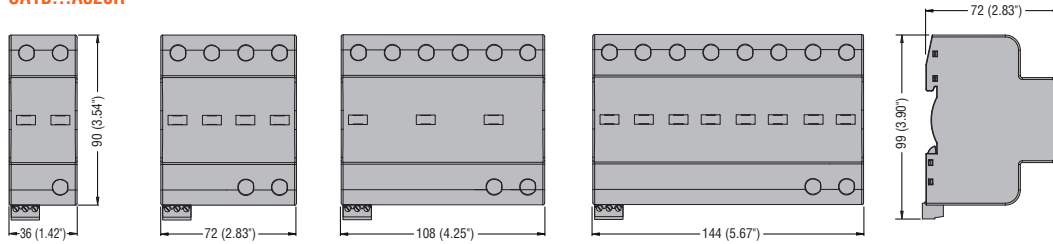

SA0...A320R

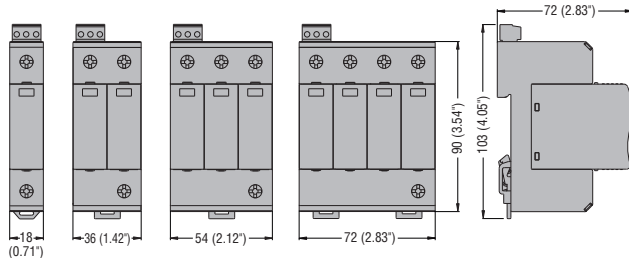

SA0B...A320R

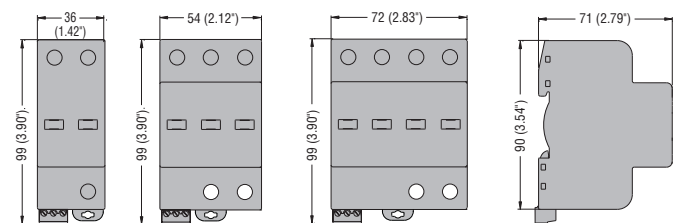

SG2...A300

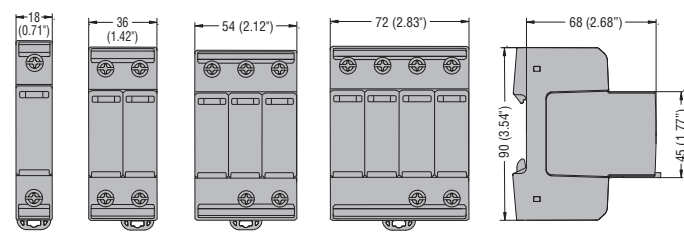

SG2C...A320

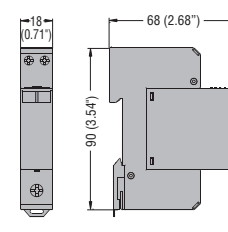

SG21PA300R

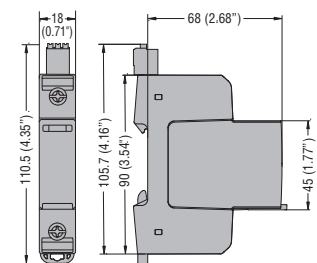

SG2...A300R

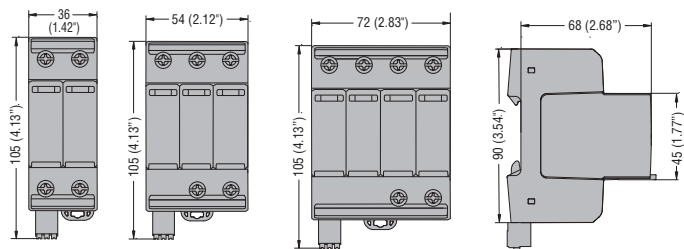

SG2DG600M2

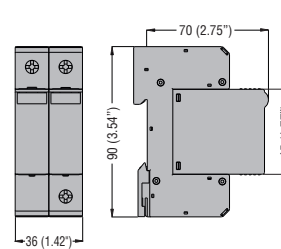

SA2EDGK10M3

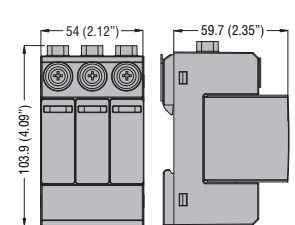

SG2DG600M2R

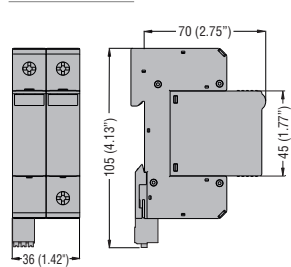

SG2DGK10M3

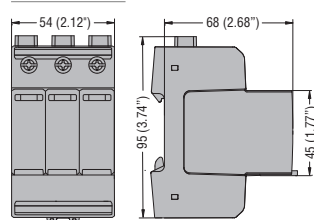

SG2DGK10M3R

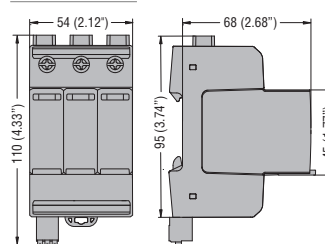

SG2EDGK10M3R

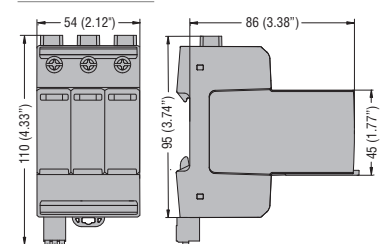

SA31NA320R

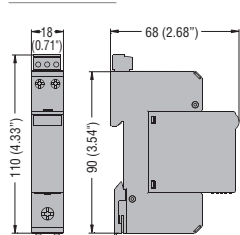

SA31NA275M...

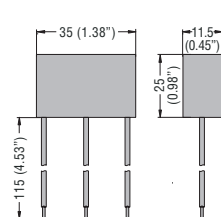

SASD5VR

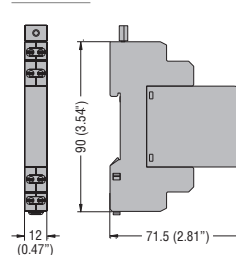

SASDET6

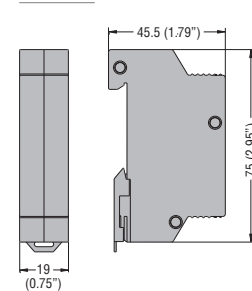

SA1B1PA320R

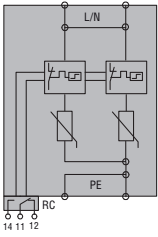

SA1B1NA320R

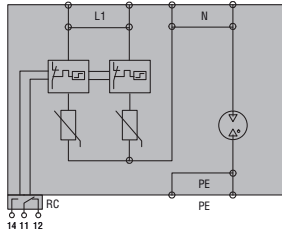

SA1B2PA320R

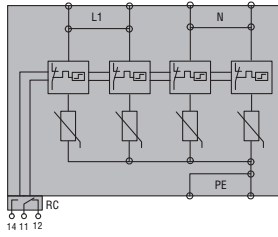

SA1B3PA320R

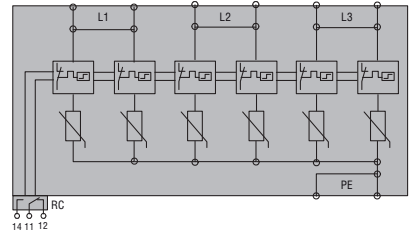

SA1B3NA320R

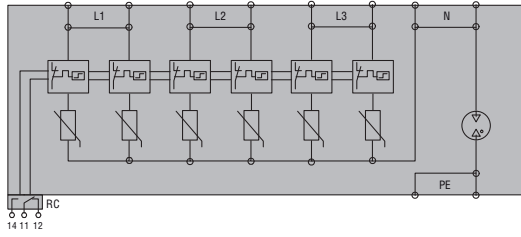

SA1B4PA320R

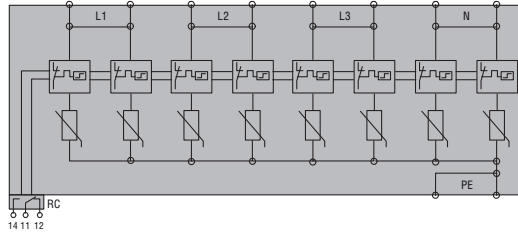

SA01PA320R

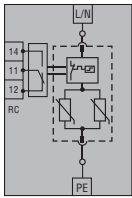

SA01NA320R

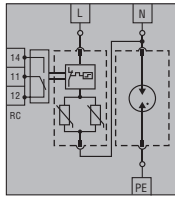

SA02PA320R

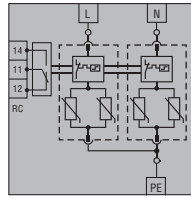

SA03PA320R

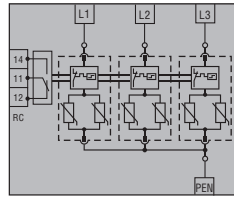

SA03NA320R

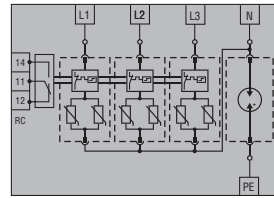

SA04PA320R

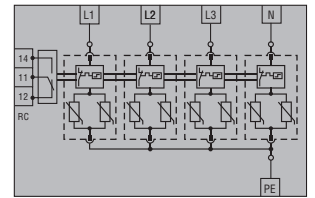

SA0B1PA320R

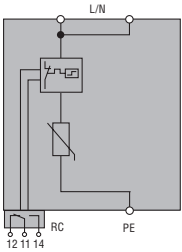

SA0B1NA320R

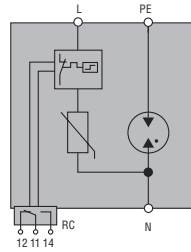

SA0B2PA320R

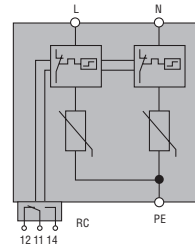

SA0B3PA320R

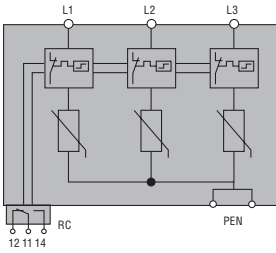

SA0B3NA320R

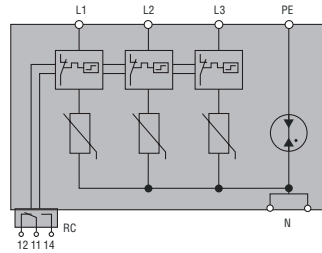

SA0B4PA320R

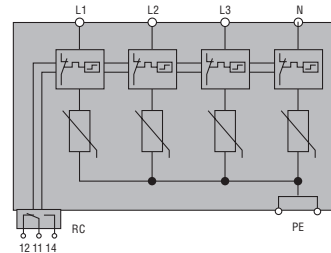

SG21PA300

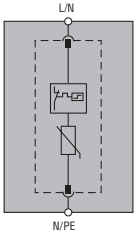

SG21NA300

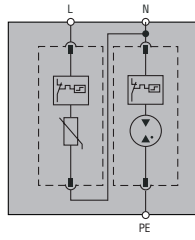

SG22PA300

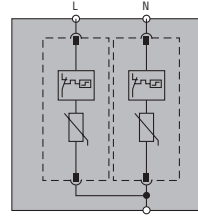

SG23PA300

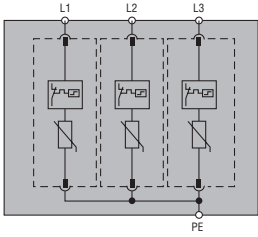

SG23NA300

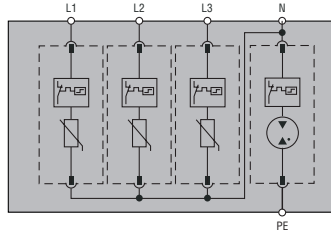

SG24PA300

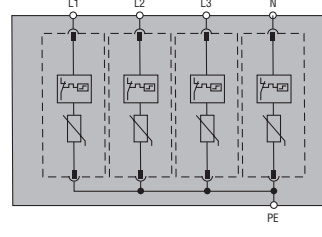

SG21PA300R

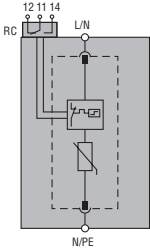

SG21NA300R

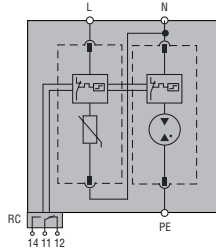

SG22PA300R

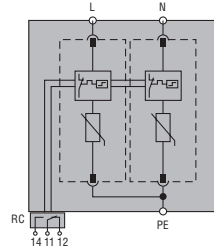

SG23PA300R

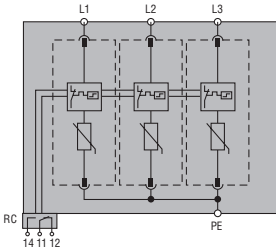

SG23NA300R

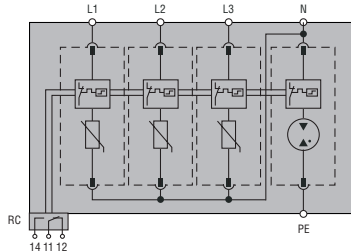

SG24PA300R

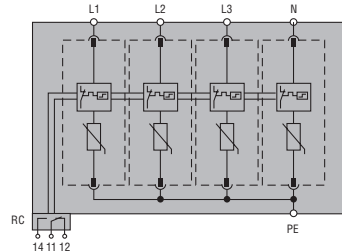

SG2C1NA320

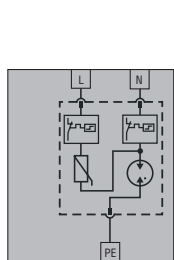

SG2C2PA320

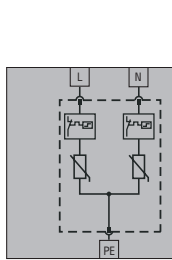

SG2DG600M2

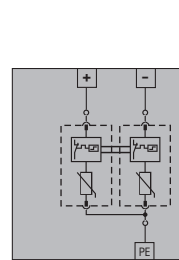

SG2DG600M2R

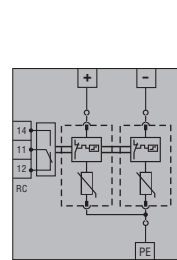

**SG2DGK10M3
SG2DGK50M3
SA2EDGK10M3**

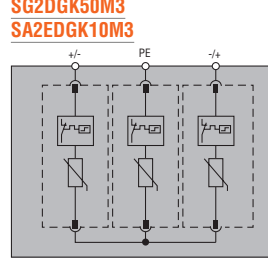

**SG2DGK10M3R
SG2EDGK10M3R**

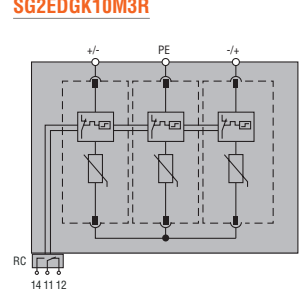

SA31NA320R

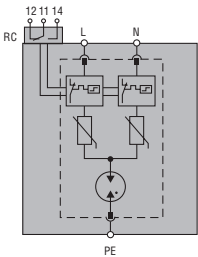

SA31NA275MS

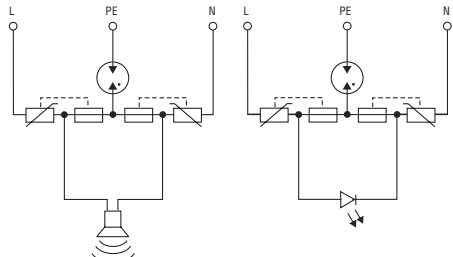

SA31NA275ML

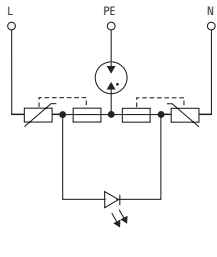

SASD5VR

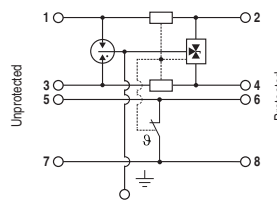

SASDET6

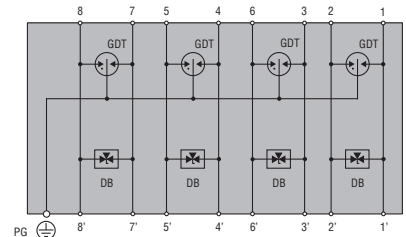

TYPE	with relay output	SA1B1PA320R	SA1B1NA320R	SA1B2PA320R	SA1B3PA320R	SA1B3NA320R	SA1B4PA320R
ELECTRICAL PROPERTIES							
SPD per IEC/EN/BS 61643-11		Type 1, 2 (test class I, II)					
IEC rated voltage U_n	VAC	230	230	230	230 / 400	230 / 400	230 / 400
IEC maximum continuous voltage U_c	VAC	320					
IEC impulse current I_{imp} (10/350) (L-N/N-PE)	kA	25	25 / 50	25 per pole	25 per pole	25 / 100	25 per pole
IEC max impulse current I_{max} (8/20) (L-N/N-PE)	kA	100	100 / 100	100 per pole	100 per pole	100 / 100	100 per pole
IEC rated discharge current I_n (8/20) (L-N/N-PE)	kA	25	25 / 50	25 per pole	25 per pole	25 / 100	25 per pole
IEC voltage protection level U_p (L-N/N-PE)	kV	<1.4	<1.4 / <1.3	<1.4	<1.4	<1.4 / <1.5	<1.4
IEC Temporary overvoltage (TOV) withstand U_t (L-N for 5s)	VAC	334					
IEC Temporary overvoltage (TOV) safe fail (L-N for 120min)	VAC	438					
IEC Temporary overvoltage (TOV) withstand (N-PE for 200ms)	VAC	–	1200V / 300A	–	–	–	1200V / 300A
IEC residual voltage U_{res} (L-N/N-PE) at 5kA (8/20)	kV	1	1	1	1.1	1.1	1.1
IEC follow current I_f (N-PE)	Arms	No	>100	No	No	>100	No
Tripping time t_a (L-N/N-PE)	ns	<25	<25 / 100	<25	<25	<25 / 100	<25
Thermal isolation protection		Yes					
Backup protection fuse (gL/gG) in case of main fuse >250A	A min	125 ($I_{imp}=10kA$)					
	A max	250					
IEC maximum short circuit current 50Hz	kA	50					
Status indicator - operating / failure	colour	Green / Red					
CONNECTIONS							
IEC degree of protection		IP20					
Terminal tightening torque	Nm	3					
Maximum conductor section	mm ²	25 (flexible) / 35 (rigid)					
RELAY OUTPUT FOR REMOTE STATUS INDICATION							
Type of contact		Changeover (NO/NC - SPDT)					
Contact capacity	A	0.5A at 250VAC; 3A at 125VAC; 0.1A at 250VDC; 0.2A at 125VDC					
Contact terminal tightening torque	Nm	0.25					
Maximum contact conductor section	mm ²	1.5					
AMBIENT CONDITIONS							
Operating temperature		-40...+80°C					
Fixing		On 35mm DIN rail (IEC/EN/BS 60715)					
Material		Thermoplastic, RAL 7035, UL 94 V-0					

TYPE	with relay output	SA01PA320R	SA01NA320R	SA02PA320R	SA03PA320R	SA03NA320R	SA04PA320R
ELECTRICAL PROPERTIES							
SPD per IEC/EN/BS 61643-11		Type 1, 2 (test class I, II)					
IEC Rated voltage Un	VAC	230	230	230	230 / 400	230 / 400	230 / 400
IEC maximum continuous voltage Uc	VAC	320					
IEC impulse current Iimp (10/350) (L-N/N-PE)	kA	12.5	12.5 / 50	12.5 per pole	12.5 per pole	12.5 / 50	12.5 per pole
IEC max discharge current I _{max} (8/20) (L-N/N-PE)	kA	60	60 / 50	60 per pole	60 per pole	60 / 50	60 per pole
IEC rated discharge current I _n (8/20) (L-N/N-PE)	kA	25	25 / 30	25 per pole	25 per pole	25 / 30	25 per pole
IEC combined surge U _{oc} /I _{sc} (1.2/50, 8/20)	kV/kA	10 / 5					
IEC voltage level protection U _p (L-N/N-PE)	kV	<1.5	<1.5 / <1.7	<1.5	<1.5	<1.5 / <1.7	<1.5
IEC Temporary overvoltage (TOV) withstand U _t (L-N for 5s)	VAC	334					
IEC Temporary overvoltage (TOV) withstand (N-PE for 200ms)	VAC	-	-	1200V / 300A	-	1200V / 300A	-
IEC residual voltage U _{res} (L-N/N-PE) at 5kA (8/20)	kV	0.8	0.8 / 0.2	0.8	0.8	0.8 / 0.2	0.8
IEC follow current I _f (N-PE)	Arms	No	>100	No	No	>100	No
Tripping time t _a (L-N/N-PE)	ns	<25	<25 / 100	<25	<25	<25 / 100	<25
Thermal isolation protection		Yes					
Backup protection fuse (gG) in case of main fuse >160A	A min	125 (I _{imp} =10kA)					
	A max	160					
IEC maximum short circuit current 50Hz	kA	25					
Status indicator - operating / failure	colour	- / Red					
CONNECTIONS							
IEC degree of protection		IP20					
Terminal tightening torque	Nm	3					
Maximum conductor section	mm ²	25 (flexible) / 35 (rigid)					
RELAY OUTPUT FOR REMOTE STATUS INDICATION							
Type of contact		Changeover (NO/NC - SPDT)					
Contact capacity	A	0.5A at 250VAC; 3A at 125VAC; 0.1A at 250VDC; 0.2A at 125VDC					
Contact terminal tightening torque	Nm	0.25					
Maximum contact conductor section	mm ²	1.5					
AMBIENT CONDITIONS							
Operating temperature		-40...+80°C					
Fixing		On 35mm DIN rail (IEC/EN/BS 60715)					
Material		Thermoplastic, RAL 7035, UL 94 V-0					

TYPE	with relay output	SA0B1PA320R	SA0B1NA320R	SA0B2PA320R	SA0B3PA320R	SA0B3NA320R	SA0B4PA320R
ELECTRICAL PROPERTIES							
SPD per IEC/EN/BS 61643-11		Type 1, 2 (test class I, II)					
IEC Rated voltage Un	VAC	230	230	230	230 / 400	230 / 400	230 / 400
IEC maximum continuous voltage Uc	VAC	320					
IEC impulse current Iimp (10/350) (L-N/N-PE)	kA	12.5	12.5 / 50	12.5	12.5	12.5 / 50	12.5
IEC max discharge current Imax (8/20) (L-N/N-PE)	kA	50	50 / 100	50	50	50 / 100	50
IEC rated discharge current In (8/20) (L-N/N-PE)	kA	20	20 / 50	20	20	20 / 50	20
IEC voltage level protection Up (L-N/N-PE)	kV	<1.5	<1.5 / <1.5	<1.5	<1.5	<1.5 / <1.5	<1.5
IEC Temporary overvoltage (TOV) withstand Ut (L-N for 5s)	VAC	334					
IEC Temporary overvoltage (TOV) safe fail (L-N for 120min)	VAC	438					
IEC Temporary overvoltage (TOV) withstand (N-PE for 200ms)	VAC	-	-	1200V / 300A	-	1200V / 300A	-
IEC follow current If (N-PE)	Arms	No	>100	No	No	>100	No
Tripping time ta (L-N/N-PE)	ns	<25	<25 / 100	<25	<25	<25 / 100	<25
Thermal isolation protection		Yes					
Backup protection fuse (gG) in case of main fuse >250A	A min	125 (Iimp=10kA)					
	A max	250					
IEC maximum short circuit current 50Hz	kA	50					
Status indicator - operating / failure	colour	Green / Red					

CONNECTIONS							
IEC degree of protection		IP20					
Terminal tightening torque	Nm	3					
Maximum conductor section	mm ²	25 (flexible) / 35 (rigid)					

RELAY OUTPUT FOR REMOTE STATUS INDICATION							
Type of contact		Changeover (NO/NC - SPDT)					
Contact capacity	A	0.5A at 250VAC; 3A at 125VAC					
Contact terminal tightening torque	Nm	0.25					
Maximum contact conductor section	mm ²	1.5					

AMBIENT CONDITIONS							
Operating temperature		-40...+85°C					
Fixing		On 35mm DIN rail (IEC/EN/BS 60715)					
Material		Thermoplastic, RAL 7035, UL 94 V-0					

TYPE	without relay output	SG21PA300	SG21NA300	SG22PA300	SG23PA300	SG23NA300	SG24PA300
	with relay output	SG21PA300R	SG21NA300R	SG22PA300R	SG23PA300R	SG23NA300R	SG24PA300R

ELECTRICAL PROPERTIES							
SPD per IEC/EN/BS 61643-11		Type 2 (test class II)					
IEC Rated voltage Un	VAC	240	240	240	240 / 400	240 / 400	240 / 400
IEC maximum continuous voltage Uc	VAC	300					
IEC max discharge current Imax (8/20) (L-N/N-PE)	kA	50	50 / 65	50	50	50 / 65	50
IEC rated discharge current In (8/20) (L-N/N-PE)	kA	20	20 / 40	20	20	20 / 40	20
IEC level protection Up (L-N/N-PE)	kV	<1.5	<1.5 / <1.5	<1.5	<1.5	<1.5 / <1.5	<1.5
IEC temporary overvoltage (TOV) Ut (L-N for 5s)	VAC	337					
IEC follow current If (N-PE)	Arms	No	100	No	No	100	No
Tripping time ta (L-N/N-PE)	ns	<25	<25 / 100	<25	<25	<25 / 100	<25
Thermal isolation protection		Yes					
Backup protection fuse (gG) in case of main fuse >315A and Ik<25kA or in case of main fuse >250A and Ik<50kA	A min	125					
	A max	315A with Isccr=25kA, 250A with Isccr=50kA					
IEC maximum short circuit current 50Hz	kA	25 / 50					
Status indicator - operating / failure	colour	Green / Red					

CONNECTIONS							
IEC degree of protection		IP20					
Terminal tightening torque	Nm	4.5					
Maximum conductor section	mm ²	25 (flexible) / 35 (rigid)					

RELAY OUTPUT FOR REMOTE STATUS INDICATION							
Type of contact		Changeover (NO/NC - SPDT)					
Contact capacity	A	1A at 250VAC; 1A at 125VAC; 0.5A at 48VDC; 0.5A at 24VDC; 0.5A at 12VDC					
Maximum contact conductor section	mm ²	1.5					

AMBIENT CONDITIONS							
Operating temperature		-40...+85°C					
Fixing		On 35mm DIN rail (IEC/EN/BS 60715)					
Material		Thermoplastic, RAL 7035, UL 94 V-0					

TYPE	without relay output	SG2C1NA320		SG2C2PA320
ELECTRICAL PROPERTIES				
SPD per IEC/EN/BS 61643-11		Type 2 (test class II)		
IEC Rated voltage Un	VAC	230		
IEC maximum continuous voltage Uc	VAC	320		
IEC max discharge current I _{max} (8/20) (L-N/N-PE)	kA	15/35	15	
IEC rated discharge current I _n (8/20) (L-N/N-PE)	kA	5/20	5	
IEC voltage level protection U _p	kV	<1.5		
IEC temporary overvoltage (TOV) U _t (L-N for 5s)	VAC	335		
IEC follow current I _f (N-PE)	Arms	>100	No	
Tripping time t _a (L-N/N-PE)	ns	<25 / 100	<25	
Thermal isolation protection		Yes		
Backup protection fuse (gG) in case of main fuse >63A	fuse A	63 gG		
IEC maximum short circuit current 50Hz	kA	6		
Status indicator - operating / failure	colour	- / Red		
CONNECTIONS				
IEC degree of protection		IP20		
Terminal tightening torque	Nm	0.5 (L,N); 3 (PE)		
Maximum conductor section	mm ²	L,N: 4 (flexible) / 6 (rigid) PE: 25 (flexible) / 35 (rigid)		
AMBIENT CONDITIONS				
Operating temperature		-40...+85°C		
Fixing		On 35mm DIN rail (IEC/EN/BS 60715)		
Material		Thermoplastic, RAL 7035, UL 94 V-0		

TYPE		SA31NA320R	SA31NA275MS	SA31NA275ML
ELECTRICAL PROPERTIES				
SPD per IEC/EN/BS 61643-11		Type 3 (test class III)		
IEC Rated voltage Un	VAC	230	230	
IEC maximum continuous voltage Uc	VAC	320	275	
Combined impulse (1.2/50; 8/20) U _{oc} /I _{cw}	kV/kA	10/5	6/3	
IEC max discharge current I _{max} (8/20)	kA	10	-	
IEC level protection U _p (L-N/N-PE)	kV	<1.5	<1.5 / <1.7	
IEC temporary overvoltage (TOV) U _t (L-N for 5s)	VAC	337		
Tripping time t _a (L-N/N-PE)	ns	<100ns		
IEC backup protection	A	63A fuse gG (line fuse >63 A)	MCB/B 16A (if MCB >16A)	
IEC maximum short circuit current 50Hz	kA	10	1	
Status indicator - operating / failure		Red replace + relay output	Acoustic (Buzzer)	Optical (LED)
CONNECTIONS				
IEC degree of protection		IP20		
Terminal tightening torque (L-N / PE)	Nm	0.5 / 3		
Maximum conductor section	mm ²	L-N: 4 (flexible) / 6 (rigid); PE: 25 (flexible) / 35 (rigid)		
RELAY OUTPUT FOR REMOTE STATUS INDICATION				
Type of contact		Changeover (NO/NC - SPDT)		
Contact capacity	A	0.5A at 250VAC; 3A at 125VAC		
Contact terminal tightening torque	Nm	0.25		
Maximum contact conductor section	mm ²	1.5		
AMBIENT CONDITIONS				
Operating temperature		-40...+85°C		
Fixing		On 35mm DIN rail (IEC/EN/BS 60715)	Socket circuit, terminal block, electrical conduct	
Material		Thermoplastic, RAL 7035, UL 94 V-0		

TYPE	for data and signal lines	SASD5VR		SASDET6	
ELECTRICAL PROPERTIES					
SPD according to IEC/EN/BS 61643-21		D1/C1/C2/C3 types			
Application		RS485		Ethernet Cat.6, Power over Ethernet (POE)	
IEC rated voltage U_n	VDC	5		48	
IEC maximum continuous voltage U_c	VDC	6		50	
C2 rated current I_n (8/20)	kA	10		10	
Maximum discharge current I_{max} (8/20)	kA	20		10	
D1 impulse current I_{imp} (10/350)	kA	2.5		1	
EN residual voltage U_{res} at 5kA (8/20)	V	<22		-	
Protection level U_p (L-L / L-PE)	V	-		150 / 550	
Load current I_L at 25°C	A	1		1	
Tripping time t_a	ns	<1		<1	
Line resistance	Ω	1.6...2.0		-	
Capacity	pF	50		-	
Bandwidth	MHz	30		250, Cat.6	
CONNECTIONS					
IEC degree of protection		IP20			
Terminal tightening torque	Nm	0.5		(RJ45 sockets)	
Conductor section (L / PE)	mm ²	4 (max) / 6 (min)		-	
RELAY OUTPUT FOR REMOTE STATUS INDICATION					
Type of contact		NC		-	
Contact capacity	A	0.5A 250VAC; 1A 50VDC		-	
Maximum contact conductor section	mm ²	0.3...4		-	
AMBIENT CONDITIONS					
Operating temperature		-40...+80°C			
Fixing		On 35mm DIN rail (IEC/EN/BS 60715)			
Material		Thermoplastic, V-0		Metal	

TYPE	without relay output	-	SG2DG600M2	SG2DGK10M3	SG2DGK50M3	SA2EDGK10M3
	with relay output	SG2EDGK10M3R	SG2DG600M2R	SG2DGK10M3R	-	-
ELECTRICAL PROPERTIES						
SPD according to EN/BS 50539-11		Type 1 and 2 (test class I and II)	Type 2 (test class II)			
IEC rated voltage U_n	VDC	1100	600	1100	1500	1100
Maximum continuous voltage U_{cpv}	VDC	1100	600	1100	1500	1100
IEC impulse current I_{imp} (10/350)	kA	6.25	-	-	-	-
Maximum discharge current I_{max} (8/20)	kA	40	40	40	30	40
Rated discharge current I_n (8/20)	kA	20	20	20	20	20
Protection level U_p	kV	<3.8	<1.9	<3.8	<5.0	<4.0
EN residual voltage U_{res} at 5kA (8/20)	kV	-	1.5	-	-	-
Tripping time t_a	ns	<25				
Thermal isolation protection		Yes				
EN maximum short circuit current I_{scpv}	A	11kA	11kA		9kA	
Status indication - operating / failure	colour	Green / Red				
CONNECTIONS						
EN degree of protection		IP20				
Terminal tightening torque	Nm	4.5	4.5		2.5	
Maximum conductor section	mm ²	25 (flexible) / 35 (rigid)				
RELAY OUTPUT FOR REMOTE STATUS INDICATION						
Type of contact		Changeover (NO/NC)				
Contact capacity	A	1A 250VAC; 1A 125VAC; 0.5A 48VDC; 0.5A 24VDC; 0.5A 12VDC				
Maximum contact conductor section	mm ²	1.5				
AMBIENT CONDITIONS						
Operating temperature		40...+85°C				
Fixing		On 35mm DIN rail (IEC/EN/BS 60715)				
Material		Thermoplastic, RAL 7035, UL 94 V-0				

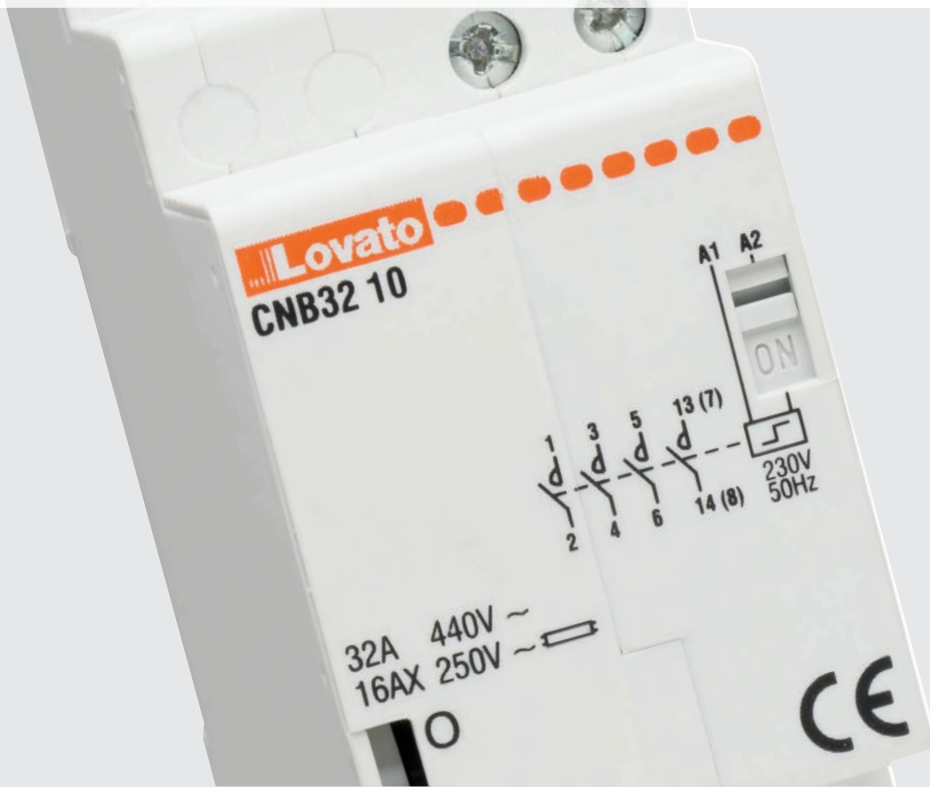

- Two, three and four-pole contactors, 20A to 63A
- Silent during operation or control stage
- Contactors with manual control
- Latching relays
- Add-on auxiliary contacts
- 12VAC or 230VAC bells and buzzers
- 12 to 63VA modular safety transformers
- Modular sockets.

	SEC. - PAGE
Modular contactors	
Contactors	16 - 2
Contactors with manual control	16 - 3
Latching relays	16 - 4
Bells and buzzers	16 - 5
Modular safety transformers	16 - 5
Modular socket	16 - 5
Dimensions	16 - 6
Wiring diagrams	16 - 7
Technical characteristics	16 - 8



Page 16-2

ONE AND TWO-POLE CONTACTORS

- IEC rated current lth AC1 (400V): 20A and 32A
- IEC rated current AC3 (400V): 9A
- Ideal for domestic and service applications.



Page 16-2

THREE AND FOUR-POLE CONTACTORS

- IEC rated current lth AC1 (400V): 25A, 32A, 40A and 63A
- IEC rated current AC3 (400V): 8.5A, 22A and 30A
- Ideal for industrial and service applications, such as office buildings, stores, hospitals, hotels, etc.



Page 16-3

ONE AND TWO-POLE CONTACTORS WITH MANUAL CONTROL

- IEC rated current lth AC1 (400V): 20A and 32A
- IEC rated current AC3 (400V): 9A
- Ideal for functional tests and dual tariff systems in domestic and service applications.



Page 16-3

THREE AND FOUR-POLE CONTACTORS WITH MANUAL CONTROL

- IEC rated current lth AC1 (400V): 32A
- IEC rated current AC3 (400V): 8.5A
- Ideal for functional tests and dual tariff systems in domestic and service applications.



Page 16-4

LATCHING RELAYS

- IEC rated current lth AC1 (400V): 20A and 32A
- IEC rated current AC3 (400V): 8.5A and 7A
- 2 position hand toggle actuator
- Coil cut-off selector
- Ideal for lights control.



Page 16-5

BELLS AND BUZZERS

- 12VAC or 230VAC power supply
- Ideal for audible signalling in domestic and service applications.



Page 16-5

MODULAR SAFETY TRANSFORMERS

- Power supply primary: 230VAC
- 12VAC or 24VAC output voltages
- Available powers: 15, 25, 40 and 63VA.



Page 16-5

MODULAR SOCKET

- 16A modular socket Italian and German (Schuko) standard.

Contactors



CN20...
CN3211... - CN3220...



CN25...
CN3210... - CN3201...



CN40...



CN63...

Order code	Rated auxiliary supply voltage	Configuration and number of contacts	Qty per pkg	Wt
	[V] ①	1NO 1NC n°	n°	[kg]

One-pole or two-pole. 1 module. Ith 20A.

CN2011024⑦	24VAC/DC	1 1②	10	0.135
CN2011220⑦	220...230VAC⑥	1 1②	10	0.135
CN2020012⑦	12VAC/DC	2 —	10	0.135
CN2020024⑦	24VAC/DC	2 —	10	0.135
CN2020220⑦	220...230VAC⑥	2 —	10	0.135
CN2002024⑦	24VAC/DC	— 2	10	0.135
CN2002220⑦	220...230VAC⑥	— 2	10	0.135

One-pole or two-pole. 1 module. Ith 32A.

CN3211024⑦⑧	24VAC/DC	1 1②	10	0.135
CN3211220⑦⑧	220...230VAC⑥	1 1②	10	0.135
CN3220012⑦⑧	12VAC/DC	2 —	10	0.135
CN3220024⑦⑧	24VAC/DC	2 —	10	0.135
CN3220220⑦⑧	220...230VAC⑥	2 —	10	0.135

Three-pole or four-pole. 2 modules. Ith 25A.

CN2510024⑤	24VAC/DC	4④ —	5	0.260
CN2510220⑤	220...230VAC⑥	4④ —	5	0.260
CN2501024⑤	24VAC/DC	3 1④	5	0.260
CN2501220⑤	220...230VAC⑥	3 1④	5	0.260
CN2522220②	220...230VAC⑥	2 2	5	0.260

Three-pole or four-pole. 2 modules. Ith 32A.

CN3210024⑤	24VAC/DC	4 —	5	0.260
CN3210220⑤	220...230VAC⑥	4 —	5	0.260
CN3201024⑤	24VAC/DC	3 1④	5	0.260
CN3201220⑤	220...230VAC⑥	3 1④	5	0.260

Three-pole or four-pole. 3 modules. Ith 40A.

CN4010024⑤	24VAC/DC	4④ —	5	0.425
CN4010220⑤	220...230VAC⑥	4④ —	5	0.425
CN4001024⑤	24VAC/DC	3 1④	5	0.425
CN4001220⑤	220...230VAC⑥	3 1④	5	0.425
CN4022220⑤	220...230VAC⑥	2 2④	5	0.425

Three-pole or four-pole. 3 modules. Ith 63A.

CN6310024	24VAC/DC	4④ —	5	0.425
CN6310220	220...230VAC⑥	4④ —	5	0.425
CN6301024	24VAC/DC	3 1④	5	0.425
CN6301220	220...230VAC⑥	3 1④	5	0.425
CN6322220	220...230VAC⑥	2 2④	5	0.425

① Other voltages on request. Consult Technical support; see contact details on front cover.

② 2NC version supplied on request.

③ The last (NC) pole has the same characteristics as the power pole. It can therefore be used indifferently as an auxiliary or as a NC power contact.

④ The fourth NO or NC pole has the same characteristics as the power poles; therefore it can be used indifferently as auxiliary or as power contact.

⑤ On request can be supplied: 4NC power poles. Consult Technical support; see contact details on front cover.

⑥ Can also operate at 220VDC.

⑦ No auxiliary contacts can be mounted.

Maximum number of contactors side-by-side

When contactors are mounted side by side and operate in continuous service (1 hour), spacing is needed between equipment to allow appropriate cooling.

9mm spacing is required; there is an accessory, called half-module spacer, order code CNX80, for this specific type of mounting. The following table indicates details of the space needed between each.

Maximum number of contactors to be mounted side-by-side without spacing; the CNX80 spacer is required when the number of pieces is more than the indicated below:

	CN20	CN32	CN25	CN40	CN63
Ambient temperature ≤40°C	3	3	3	3	3
Ambient temperature >40°...55°C	2	2	2	3	2

General characteristics

- DC powered magnetic core system assuring silent operation and noise damping during the control phase
- Overvoltage protection circuit and voltage peak limitation of the magnetic core
- Equipped with 2 or 4 closing contacts of equal capacity permitting use in power or auxiliary circuits
- Operation flag indicator.

Operational characteristics

Type	IEC conventional free-air thermal current Ith, AC1 and AC-7a ≤400V	Operational current AC3 and AC-7b ≤400V	Protection fuse gG (IEC)
	[A]	[A]	[A]

One-pole or two-pole.

CN20...	20	9	20
CN32...	32	9	32

Three-pole or four-pole.

CN25...	25	8.5	25
CN32...	32	8.5	32
CN40...	40	22	63
CN63...	63	30	80

- Noise level:
 - Closed contactor <20dB
 - Making/breaking operation ≤50dB
- IEC degree of protection: IP20
- Mounting on 35mm DIN rail (IEC/EN/BS 60175).

Operational characteristics of contactor-incorporated auxiliary contacts

Type	IEC insulation voltage Ui	IEC rating (AC15 category)	
	[V]	230V	400V
		[A]	[A]
CN20...	440	6	6
CN25...	440	6	4
CN32...	440	6	4
CN40...	500	6	4
CN63...	500	6	4

Utilisation

- Lighting systems
- Electric home heating
- Heat pumps
- Conditioning
- Ventilation
- Civil installations.

Lighting circuit switching

See pages 16-10 and 11.

Special versions

Contactors with Mirror Contact function, as per IEC/EN/BS 60947-4-1 Standard, Annex F, are available on request. Consult Technical support; see contact details on front cover.

Certifications and compliance

Certifications obtained: EAC.
Compliant with standards: IEC/EN/BS 60947-1, IEC/EN/BS 60947-4-1, IEC/EN/BS 60947-5-1, IEC/EN/BS 61095.

Contactor with manual control



CNM20... - CNM3220...



CNM3210...

Order code	Rated auxiliary supply voltage	Configuration and number of contacts	Qty per pkg	Wt
	[V] ❶	1NO 1NC	n°	[kg]
One-pole or two-pole. 1 module. Ith 20A.				
CNM2011024❶❷	24VAC/DC	1 1❸	10	0.135
CNM2011220❶❷	220...230VAC❸	1 1❸	10	0.135
CNM2020012❶❷	12VAC/DC	2 —	10	0.135
CNM2020024❶❷	24VAC/DC	2 —	10	0.135
CNM2020220❶❷	220...230VAC❸	2 —	10	0.135
One-pole or two-pole. 1 module. Ith 32A.				
CNM3220012❶❷	12VAC/DC	2 —	10	0.135
CNM3220024❶❷	24VAC/DC	2 —	10	0.135
CNM3220220❶❷	220...230VAC❸	2 —	10	0.135
Three-pole or four-pole. 2 module. Ith 32A.				
CNM3210024❶❷	24VAC/DC	4❹ —	5	0.260
CNM3210220❶❷	220...230VAC❸	4❹ —	5	0.260

- ❶ Other voltages on request. Consult Technical support; see contact details on front cover.
- ❷ 2NC version supplied on request.
- ❸ The last (NC) pole has the same characteristics as the power pole. It can therefore be used indifferently as an auxiliary or as a NC power contact.
- ❹ The fourth NO or NC pole has the same characteristics as the power poles; therefore it can be used indifferently as auxiliary or as power contact.
- ❺ Can also operate at 220VDC.
- ❻ No auxiliary contacts can be mounted.

Maximum number of contactors side-by-side

When contactors are mounted side by side and operate in continuous service (1 hour), spacing is needed between equipment to allow appropriate cooling. 9mm spacing is required; there is an accessory, called half-module spacer, order code CNX80, for this specific type of mounting. The following table indicates details of the space needed between each.

Maximum number of contactors to be mounted side-by-side without spacing; the CNX80 spacer is required when the number of pieces is more than the indicated below:

	CNM20	CNM32
Ambient temperature ≤40°C	3	3
Ambient temperature >40°...55°C	2	2

Add-on blocks and accessories for contactors and contactors with manual control



CNH...



CNP2

Order code	Characteristics	Max qty per contactor	Qty per pkg	Wt
		n°	n°	[kg]
Auxiliary contacts❹.				
CNH11❹	1NO + 1NC	1	1	0.044
CNH20❹	2NO	1	1	0.044
Set for terminal protection (also sealable).				
CNP0	For CN20..., CNM20... and CNM32...	2	1❺	0.001
CNP1	For CN25... and CNM32...	2	1❺	0.002
CNP2	For CN40... and CN63...	2	1❺	0.003
Spacer.				
CNX80	1/2 mod. wide	1	10	0.013

General characteristics

- DC powered magnetic core system assuring silent operation and noise damping during the control phase
- Overvoltage protection circuit and voltage peak limitation of the magnetic core
- Equipped with 2 or 4 closing contacts of equal capacity permitting use in power or auxiliary circuits
- Operation flag indicator
- Handle functions
Position A: contactor function.
Position O: contactor permanently switched off, even in case of coil control voltage is present.
Position I: contactor closed manually; when the coil is supplied the handle automatically moves to A position.

Operational characteristics

Type	IEC conventional free-air thermal current Ith AC1 and AC-7a ≤400V [A]	Operational current AC3 and AC-7b ≤400V [A]	Protection fuse gG (IEC) [A]
One-pole or two-pole.			
CNM20...	20	9	20
CNM32...	32	9	32
Three-pole or four-pole.			
CNM32...	32	8.5	32

One-pole or two-pole.

CNM20...	20	9	20
CNM32...	32	9	32

Three-pole or four-pole.

CNM32...	32	8.5	32
----------	----	-----	----

- Noise level:
 - Closed contactor <20dB
 - Making/breaking operation ≤50dB
- IEC degree of protection: IP20
- Mounting on 35mm DIN rail (IEC/EN/BS 60175).

Operational characteristics of contactor-incorporated auxiliary contacts

Type	IEC insulation voltage Ui [V]	IEC rating (AC15 category)	
		230V [A]	400V [A]
CNM20...	440	6	6
CNM32...	440	6	4

Utilisation

- Lighting systems
- Electric home heating
- Heat pumps
- Conditioning
- Ventilation
- Civil installations.

Lighting circuit switching

See pages 16-10 and 11.

Certifications and compliance

Certifications obtained: EAC.
Compliant with standards: IEC/EN/BS 60947-1, IEC/EN/BS 60947-4-1, IEC/EN/BS 60947-5-1, IEC/EN/BS 61095.

Operational characteristics for auxiliary contacts

- IEC rated insulation voltage: 440VAC
- IEC conventional free air thermal current Ith: 6A
- Minimum switching capacity: 5mA 12V
- Conductor section: 1...2.5mm²
- Maximum tightening torque: 1Nm.

Certifications and compliance

Certifications obtained: EAC.
Compliant with standards: IEC/EN/BS 60947-1, IEC/EN/BS 60947-4-1, IEC/EN/BS 60947-5-1, IEC/EN/BS 61095.

❹ Not suitable for CN20..., CN32 11..., CN32 20..., CNM20... and CNM32... modular contactors.
❺ Set of 2 pieces.

Latching relays



CNB20... - CNB3220...



CNB3210...

Order code	Rated auxiliary supply voltage	Configuration and number of contacts	Qty per pkg	Wt
	[V] ①	1NO 1NC	n°	[kg]
One-pole or two-pole. 1 module. lth 20A.				
CNB2010230	230VAC	1 —	8	0.135
CNB2011012	12VAC	1 ②	8	0.135
CNB2011024	24VAC	1 ②	8	0.135
CNB2011230	230VAC	1 ②	8	0.135
CNB2020012	12VAC	2 —	8	0.135
CNB2020024	24VAC	2 —	8	0.135
CNB2020230	230VAC	2 —	8	0.135
One-pole or two-pole. 1 module. lth 32A.				
CNB3220012	12VAC	2 —	8	0.135
CNB3220024	24VAC	2 —	8	0.135
CNB3220230	230VAC	2 —	8	0.135
Three-pole or four-pole. 2 module. lth 32A.				
CNB3210012	12VAC	4 ③ —	4	0.195
CNB3210024	24VAC	4 ③ —	4	0.195
CNB3210230	230VAC	4 ③ —	4	0.195

- ① Other voltages on request. Consult Technical support; see contact details on front cover.
- ② The last (NC) pole has the same characteristics as the power pole. It can therefore be used indifferently as an auxiliary or as a NC power contact.
- ③ The fourth NO or NC pole has the same characteristics as the power poles; therefore it can be used indifferently as auxiliary or as power contact.

General characteristics

- Mechanical system that keeps the contactor in position without the coil being powered
- Includes a manual control system and a switch to lock the coil command
- Equipped with 2 or 4 closing contacts of equal capacity permitting use in power or auxiliary circuits
- Operation flag indicator
- No consumption of the closed electromagnet contactor with considerable advantages in reducing the dissipated heat.

Operational characteristics

Type	IEC conventional free-air thermal current Ith, AC1 and AC-7a ≤400V [A]	Operational current AC3 and AC-7b [A]	Protection fuse gG (IEC) [A]
One-pole or two-pole.			
CNB20...	20	9	20
CNB32...	32	9	32
Three-pole or four-pole.			
CNB32...	32	8.5	32

One-pole or two-pole.

CNB20...	20	9	20
CNB32...	32	9	32

Three-pole or four-pole.

CNB32...	32	8.5	32
----------	----	-----	----

- Noise level:
 - Closed contactor 0dB (mechanically closed)
 - Making/breaking operation ≤50dB
- IEC degree of protection: IP20
- Mounting on 35mm DIN rail (IEC/EN/BS 60175).

Operational characteristics of contactor-incorporated auxiliary contacts

Type	IEC insulation voltage Ui [V]	IEC rating (AC15 category)	
		230V [A]	400V [A]
CNB20...	440	6	6
CNB32...	440	6	4

Utilisation

- Lighting systems
- Electric home heating
- Heat pumps
- Conditioning
- Ventilation
- Civil installations.

Certifications and compliance

Certifications obtained: EAC.
 Compliant with standards: IEC/EN/BS 60947-1, IEC/EN/BS 60947-4-1, IEC/EN/BS 60947-5-1, IEC/EN/BS 61095, IEC/EN/BS 60669-1, IEC/EN/BS 60669-2-2.

Add-on blocks and accessories



CNBX...



CNP3

Order code	Characteristics	Max qty per contactor	Qty per pkg	Wt
		n°	n°	[kg]
Auxiliary contacts.				
CNBX11	1NO + 1NC	1	1	0.032
CNBX20	2NO	1	1	0.032
Set for terminal protection (also sealable).				
CNP3	For CNB...	④	1⑤	0.002

- ④ To cover all the terminals, mount: 2 pieces for one module latching relay; 2 set of 2 pieces for two module latching relay.
- ⑤ Set of 2 pieces.

Operational characteristics for auxiliary contacts

- IEC rated insulation voltage: 440VAC
- IEC conventional free air thermal current Ith: 6A
- Minimum switching capacity: 5mA 12V
- Conductor section: 1...2.5mm²
- Maximum tightening torque: 1Nm.

Certifications and compliance

Certifications obtained: EAC.
 Compliant with standards: IEC/EN/BS 60947-1, IEC/EN/BS 60947-5-1, IEC/EN/BS 61095.

Bells and buzzers



CBE... CBZ230A



CTRB15VA

new

Order code	Description	Supply voltage	Output voltage	Qty per pkg	Wt
		[VAC]	[VAC]	n°	[kg]
CBE012A	Modular bell	12	–	1	0.077
CBE230A	Modular bell	230	–	1	0.073
CBZ230A	Modular buzzer	230	–	1	0.063
CTRB15VA	Modular transformer for 15VA bell	230	12	1	0.339

General and operational characteristics

- Sound intensity, distance 1m: buzzer 80dB, bells 84dB
- Power consumption: 10VA (5VA for CBE012A)
- Operating temperature: -10...+55°C (-10...+40°C for CTRB15VA)
- Storage temperature: -40...+80°C
- Conductor section (min...max): 0.5...1.5mm²
- Tightening torque: 0.5Nm
- Screw terminals: M3
- DIN modules: CBE... 1 module
CBZ... 1 module
CTRB15VA 2 modules
- CTRB15VA can only be used for bell power supply (intermittent operation)
- CTRB15VA overload and short circuit protection integrated (PTC).

Certifications and compliance

Certifications obtained: EAC (except CTRB15VA).
Compliant with standards: IEC/EN/BS 62080.

Modular safety transformers



CTRS...

new

Order code	Power	Supply voltage	Output voltage	Qty per pkg	Wt
	[VA]	[VAC]	[VAC]	n°	[kg]
CTRS15VA	15	230	12-24	1	0.477
CTRS25VA	25	230	12-24	1	0.582
CTRS40VA	40	230	12-24	1	0.846
CTRS63VA	63	230	12-24	1	1.319

General and operational characteristics

- Safety transformers suitable for continuous operation
- Overload and short circuit protection integrated (PTC)
- Operating temperature: -10...+25°C
- Storage temperature: -40...+70°C
- Conductor section (min...max): 0.5...1.0mm²
- Tightening torque: 1Nm
- Screw terminals: M4
- DIN modules: CTRS15VA 3 modules
CTRS25VA 3 modules
CTRS40VA 4 modules
CTRS63VA 6 modules.

Reference standards

Compliant with standards: IEC/EN/BS 61558-2-8.

Modular socket



P1X7

Order code	Description	Qty per pkg	Wt
		n°	[kg]
P1X7	Modular socket Italian and German (Schuko) standard; 16A	5	0.123

General and operational characteristics

- Operating temperature: -25...+45°C
- Storage temperature: -40...+75°C
- Max. current: 16A
- Connectable section 1.5...10mm²
- Tightening torque: 1.8Nm
- Fixing on 35mm DIN rail (IEC/EN/BS 60715)
- DIN modules: 2.5.

Certifications and compliance

Certifications obtained: EAC.
Compliant with standards: IEC/BS 60884-1.

MODULAR CONTACTORS

CN20... - CN32... (one-pole - two-pole)

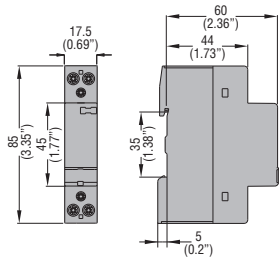

CN25... - CN32... (three-pole - four-pole)

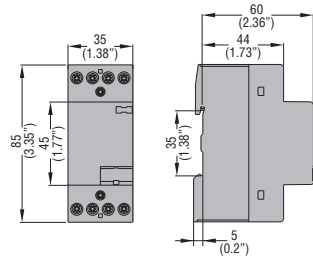

CN40... - CN63... (three-pole - four-pole)

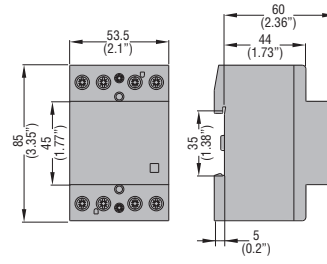

MODULAR CONTACTORS WITH MANUAL CONTROL

CNM20... - CNM32... (one-pole - two-pole)

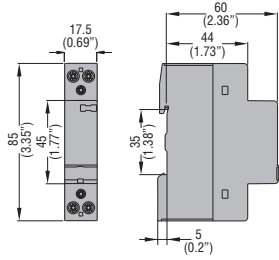

CNM32... (three-pole - four-pole)

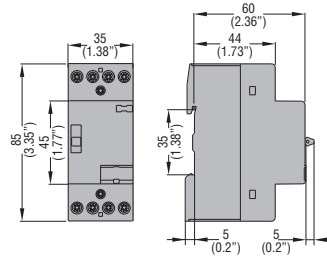

LATCHING RELAYS

CNB20... - CNB32... (one-pole - two-pole)

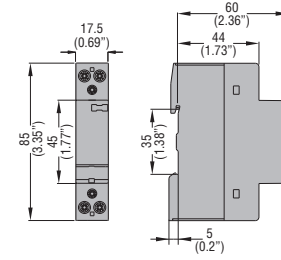

CNB32... (three-pole - four-pole)

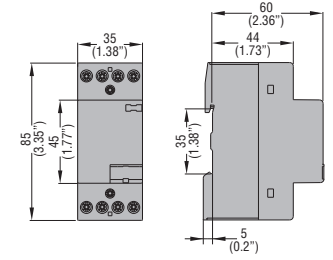

ADD-ON BLOCKS AND ACCESSORIES

Auxiliary contacts

CNH... - CNBX...

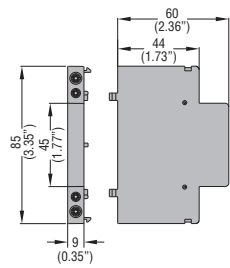

Spacer

CNX80

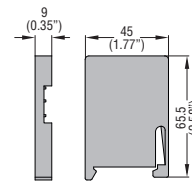

BELLS

CBE...

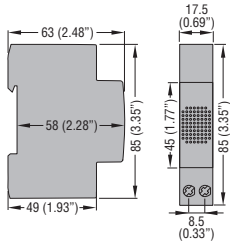

BUZZER

CBZ230A

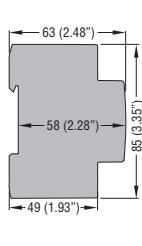

TRANSFORMER FOR BELLS

CTRB15VA

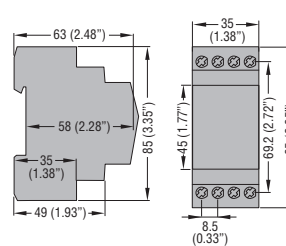

MODULAR SAFETY TRANSFORMERS

CTRS15VA - CTRS25VA

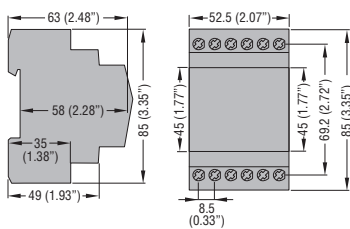

CTRS40VA

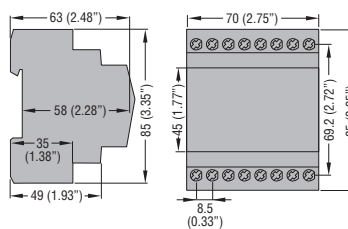

CTRS63VA

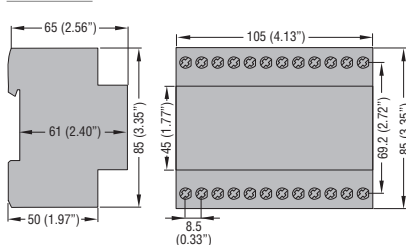

MODULAR SOCKET

P1X7

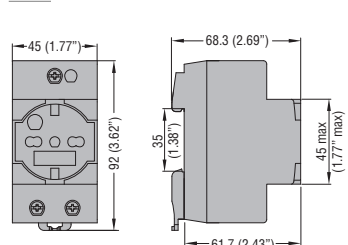

ONE-POLE AND TWO-POLE MODULAR CONTACTORS

CN2011
CN3211
CNM2011

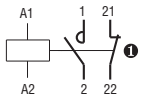

CN2020
CN3220
CNM2020
CNM3220

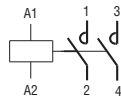

CN2002

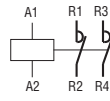

THREE-POLE AND FOUR-POLE MODULAR CONTACTORS

CN2501
CN3201
CN4001
CN6301

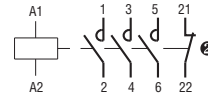

CN2510
CN3210
CN4010
CN6310
CNM3210

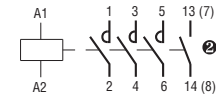

CN2522
CN4022
CN6322

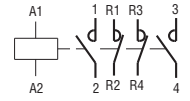

- ① The NC contact has the same characteristics as the power pole contact. Therefore, it can be used indifferently as an auxiliary or as a NC power pole contact.
- ② The fourth pole NO or NC has the same characteristics as the power poles. Therefore, it can be used indifferently as auxiliary or as power pole contact.

LATCHING RELAYS

CNB2010

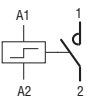

CNB2011

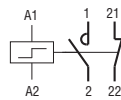

CNB2020
CNB3220

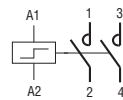

CNB3210

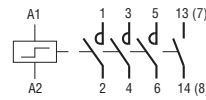

ADD-ON AUXILIARY CONTACTS

CNH11
CNBX11



CNH20
CNBX20

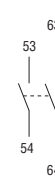

BELLS

CBE012A

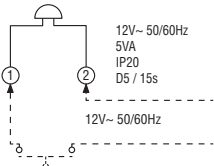

CBE230A

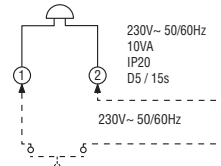

BUZZER

CBZ230A

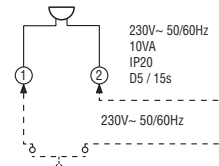

TRANSFORMER FOR BELLS

CTRB15VA

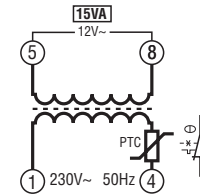

MODULAR SAFETY TRANSFORMERS

CTRS15VA

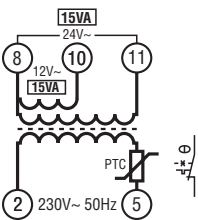

CTRS25VA

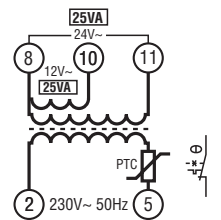

CTRS40VA

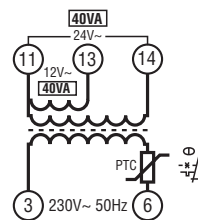

CTRS63VA

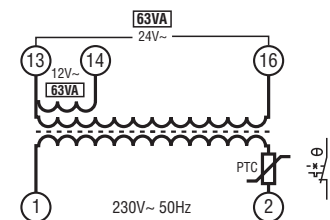

TYPE		CN20... - CNM20...	CN25...	CN32... - CNM32... (one-pole and two-pole)	CN32... - CNM32... (three-pole and four-pole)	CN40...	CN63...
CONTACT CHARACTERISTICS							
IEC conventional free-air thermal current I _{th} (≤40°C)	A	20	25	32	32	40	63
IEC rated insulation voltage U _i	V	230	440	230	440	440	440
IEC rated impulse withstand voltage U _{imp}	kV	4	4	4	4	4	4
Minimum switching capacity		17V ≥50mA	17V ≥50mA	17V ≥50mA	17V ≥50mA	17V ≥50mA	17V ≥50mA
Power dissipation for I _{th} pole	W	1.7	2	2.5	2.5	4	8
Maximum tightening torque for coil terminals	Nm	0.6	0.6	0.6	0.6	0.6	0.6
	lb.in	5.3	5.3	5.3	5.3	5.3	5.3
	Pozidr.	PZ1	PZ1	PZ1	PZ1	PZ2	PZ2
Coil conductor section	min.	mm ² 1					
	max.	mm ² 2.5					
Maximum tightening torque for power terminals	Nm	1.2	1.2	1.2	1.2	2	2
	lb.in	10.6	10.6	10.6	10.6	18	18
	Tool	PZ1	PZ1	PZ1	PZ1	PZ2	PZ2
Power conductor section	min.	mm ² 2.5					
	max.	mm ² 6					
AC/DC CONTROL CIRCUIT							
Average coil consumption in-rush and holding	W	2.5	3	2.5	3	5	5
Operating voltage limits	pick-up	% U _s	85...110				
	drop-out	% U _s	20...75				
OPERATING TIMES							
Average time	closing NO	ms	15...45	15...45	15...45	15...45	15...20
	opening NO	ms	25...50	20...70	20...50	20...70	35...45
LIFE							
Mechanical	cycles	3,000,000	3,000,000	3,000,000	3,000,000	3,000,000	3,000,000
Electrical (in AC3 duty)	cycles	300,000	500,000	500,000	500,000	150,000	150,000
Electrical (in AC1 duty)	cycles	200,000	200,000	150,000	150,000	100,000	100,000
AMBIENT CONDITIONS							
Operating temperature	°C	-5...+55❶					
Storage temperature	°C	-30...+80					

❶ -25...+70°C (2NO or 4NO configuration). When the operating temperature is between +55°C and +70°C, it is compulsory to have a free space of at least 9mm on the side faces of the contactor.

TYPE		CNB20	CNB32... (one-pole and two-pole)	CNB32... (three-pole and four-pole)
CONTACT CHARACTERISTICS				
IEC conventional free-air thermal current I _{th} (≤40°C)	A	20	32	32
IEC rated insulation voltage U _i	V	440		
IEC rated impulse withstand voltage U _{imp}	kV	4		
Minimum switching capacity		≥10V ≥100mA		
Max fuse size, gG type, for Type 1 coordination, 400V - 3kA	A	20	32	32
Power dissipation for I _{th} pole	W	1.5	3	3
Maximum tightening torque for coil terminals	Nm	0.6	0.6	0.6
	lb.in	5.3	5.3	5.3
	Pozidr.	PZ1	PZ1	PZ1
Coil conductor section	min.	mm ² 1		
	max.	mm ² 4		
Maximum tightening torque for power terminals	Nm	1.2	1.2	1.2
	lb.in	10.6	10.6	10.6
	Pozidr.	PZ2	PZ2	PZ2
Power conductor section	min.	mm ² 1		
	max.	mm ² 10		
CONTROL CIRCUIT				
Coil consumption - In-rush	VA/W	18/13	18/13	7
Max. recommended impulse duration	m/s	50/100		
Min. time between two impulses	m/s	150		
Maximum supply time	h	1		
Operating voltage limits closing	% U _s	85...110		
OPERATING TIMES				
Average time	closing NO	ms	5...20	
	opening NO	ms	25...50	
LIFE				
Mechanical	cycles	1,000,000		
Electrical (in AC3 duty)	cycles	100,000		
Electrical (in AC1 duty)	cycles	100,000		
AMBIENT CONDITIONS				
Operating temperature	°C	-25...+55		
Storage temperature	°C	-30...+80		

LIGHTING CIRCUIT SWITCHING

Lamp features	Lamp power	Rated current	Capacitor power	Maximum number [n] of lamps each contactor pole 230V 50Hz				
	[W]	[A]	[µF]	CN20... - CNM20... CNB20...	CN25...	CN32... - CNM32... CNB32...	CN40	CN63
LED LIGHTING BALLAST	N = number of controlled ballasts In = ballast rated current in mA			N = 2400 / In	N = 3800 / In	N = 4000A / In	N = 11000 / In	N = 18000 / In
INCANDESCENT AND TUNGSTEN HALOGEN	60	0.26	-	33	37	42	67	83
	100	0.44	-	20	22	25	40	50
	500	2.17	-	4	4	5	8	10
	1000	4.35	-	2	2	3	4	5
COMPACT FLUORESCENT (ENERGY SAVING)	3	0.04	-	150	200	250	550	700
	5	0.06	-	90	120	150	330	420
	6	0.07	-	75	100	125	275	350
	7	0.08	-	64	86	107	236	300
	8	0.09	-	56	75	94	206	263
	9	0.1	-	50	67	83	183	233
	10	0.11	-	45	60	75	165	210
	11	0.12	-	41	55	68	150	191
	12	0.13	-	38	50	63	138	175
	13	0.14	-	35	46	58	127	162
	14	0.15	-	32	43	54	118	150
	15	0.16	-	30	40	50	110	140
	16	0.18	-	28	38	47	103	131
	17	0.19	-	26	35	44	97	124
	18	0.2	-	25	33	42	92	117
	20	0.21	-	23	30	38	83	105
	21	0.22	-	21	29	36	79	100
	22	0.23	-	20	27	34	75	95
	23	0.24	-	20	26	33	72	91
	24	0.25	-	19	25	31	69	88
	25	0.26	-	18	24	30	66	84
	26	0.27	-	17	23	29	63	81
	27	0.124	-	17	22	28	61	78
30	0.15	-	15	20	25	55	70	
50	0.24	-	9	12	15	33	42	
70	0.312	-	6	9	11	24	30	
FLUORESCENT not corrected	18	0.37	-	24	30	35	54	86
	25	0.29	-	30	39	45	69	110
	36	0.43	-	20	26	30	47	74
	58	0.67	-	13	17	19	30	48
FLUORESCENT corrected	18	0.19	4.5	7	8	9	49	73
	25	0.15	3.5	9	10	11	63	94
	36	0.29	4.5	7	8	9	49	73
	58	0.46	7	4	5	6	31	47
ELECTRONIC FLUORESCENT BALLAST	14	0.08	-	44	59	64	156	225
	2x14	0.15	-	23	32	34	83	120
	18	0.09	-	39	53	57	139	200
	2x18	0.17	-	21	28	30	74	106
	21	0.11	-	32	43	46	114	164
	2x21	0.22	-	16	22	23	57	82
	28	0.14	-	25	34	36	89	129
	2x28	0.27	-	13	18	19	46	67
	36	0.16	-	22	30	32	78	113
	2x36	0.31	-	11	15	16	40	58
	40	0.21	-	17	23	24	60	86
	2x40	0.42	-	8	11	12	30	43
	58	0.25	-	14	19	20	50	72
	2x58	0.48	-	7	10	11	26	38
	70	0.3	-	12	16	17	42	60
	2x70	0.57	-	6	8	9	22	32
HIGH-PRESSURE MERCURY VAPOUR not corrected	50	0.6	-	14	18	20	38	55
	80	0.8	-	10	13	15	29	42
	125	1.2	-	7	9	10	20	29
	250	2.2	-	4	5	6	10	15
	400	3.3	-	2	3	4	7	10
	700	5.4	-	1	2	3	4	6
1000	7.5	-	1	1	2	3	4	

① Usually each LED lamp has one ballast.

In event of one ballast supplies several lamps, the calculation has to consider the number of supplied ballasts.

E.G. If the LED lamp ballast input current is 500mA, (consider CN40=11,000/500=22), the maximum number of ballasts admitted per each pole of CN40 contactor is 22.

LIGHTING CIRCUIT SWITCHING

Lamp features	Lamp power [W]	Rated current [A]	Capacitor power [µF]	Maximum number [n] of lamps each contactor pole 230V 50Hz				
				CN20... - CNM20... CNB20...	CN25...	CN32... - CNM32... CNB32...	CN40	CN63
HIGH-PRESSURE MERCURY VAPOUR corrected	50	0.3	7	4	5	6	31	47
	80	0.4	8	4	5	5	27	41
	125	0.6	10	3	4	4	22	33
	250	1.2	18	1	2	2	12	18
	400	1.8	25	1	1	1	9	13
	700	3.4	40	0	0	1	5	7
METAL HALIDE not corrected	1000	4.8	60	0	0	0	4	5
	35	0.5	-	18	22	28	43	60
	70	1	-	10	12	14	23	32
	100	1.2	-	8	10	11	19	26
	150	1.8	-	5	7	7	12	18
	250	3	-	3	4	4	7	10
	400	4.6	-	3	3	3	6	9
	600	6.2	-	1	2	2	3	4
METAL HALIDE corrected	1000	9.7	-	1	1	1	2	3
	2000	12.2	-	0	0	1	1	2
	35	0.23	6	5	6	6	36	50
	70	0.42	12	2	3	3	18	25
	100	0.55	12	2	3	3	18	25
	150	0.77	20	1	1	1	11	15
	250	1.26	32	0	1	1	6	9
	400	2	45	0	0	0	5	7
HIGH-PRESSURE SODIUM VAPOUR not corrected	600	3	65	0	0	0	3	5
	1000	5	85	0	0	0	2	3
	2000	10.5	125	0	0	0	1	2
	100	1.2	-	7	8	9	25	30
	150	1.8	-	5	6	6	17	22
	250	3	-	3	4	4	10	13
HIGH-PRESSURE SODIUM VAPOUR corrected	400	4.4	-	2	2	2	6	8
	600	6.2	-	1	1	1	4	5
	1000	10.3	-	0	1	1	3	3
	100	0.55	12	2	3	3	18	27
	150	0.77	20	1	1	2	11	16
	250	1.26	32	0	1	1	6	10
LOW-PRESSURE SODIUM VAPOUR not corrected	400	2	45	0	0	0	4	6
	600	2.9	65	0	0	0	3	5
	1000	5.1	100	0	0	0	2	3
	18	0.4	-	22	27	30	71	90
	35	0.6	-	7	9	10	23	30
	55	0.6	-	7	9	10	23	30
LOW-PRESSURE SODIUM VAPOUR corrected	90	0.9	-	4	5	6	14	19
	135	0.9	-	3	4	5	10	13
	180	0.9	-	3	4	5	10	13
	18	0.35	5	6	7	8	44	66
	35	0.28	20	1	1	2	11	16
	55	0.35	20	1	1	2	11	16
LOW-PRESSURE SODIUM VAPOUR with electronic ballast	90	0.55	26	1	1	1	8	12
	135	0.8	40	0	0	1	4	7
	180	1	40	0	0	1	5	8
	35	0.16	-	13	18	21	35	44
	55	0.25	-	8	11	13	22	28

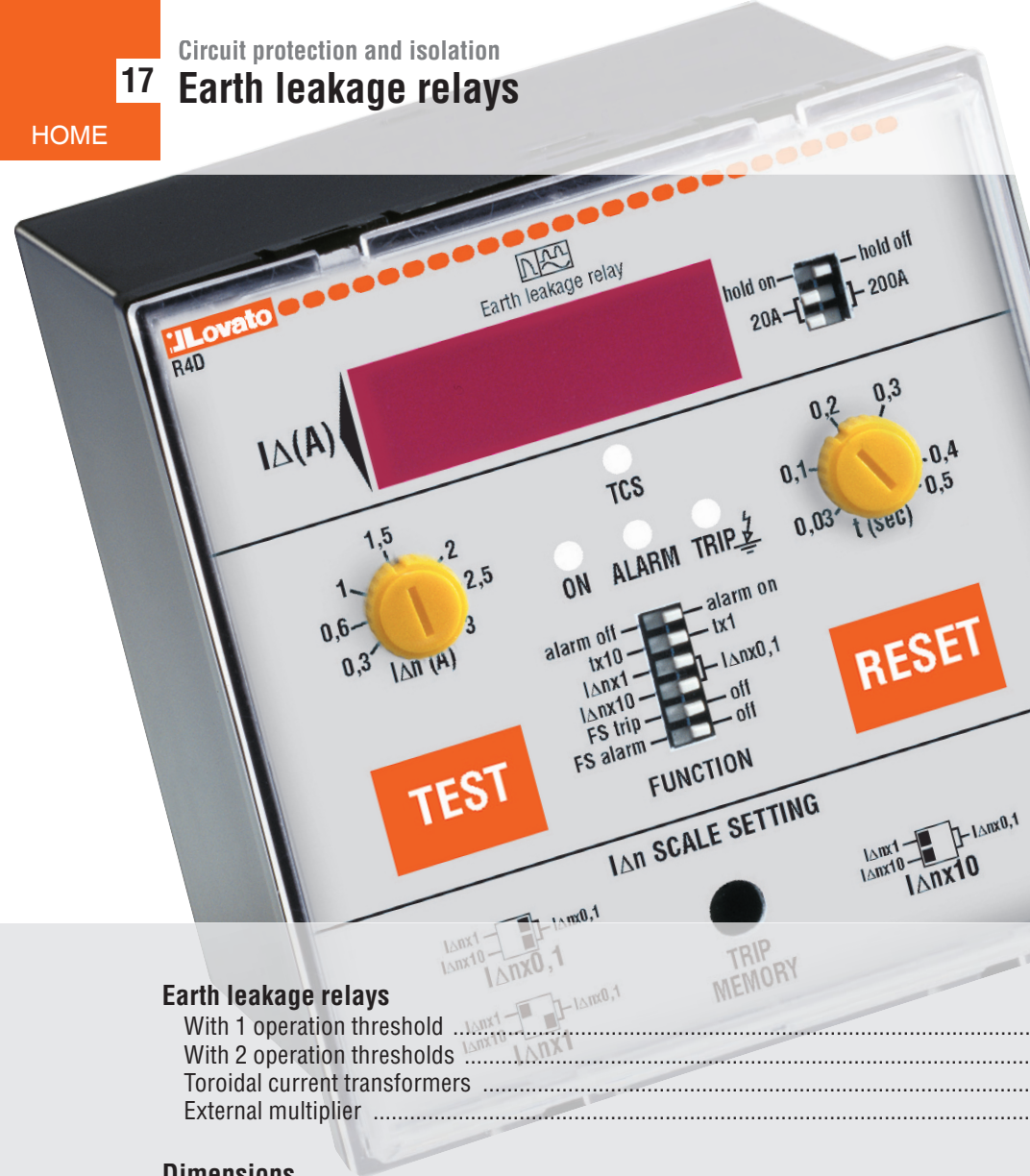

- Modular, flush and internal panel mount version, with or without flag indicator, configurable prealarm indication and fail safe operation
- Versions with automatic toroid connection control
- Choice of supply voltage ranges
- Adjustable fault current $I_{\Delta n}$
- Adjustment and choice of tripping range for both fault current and delay time.

Earth leakage relays

With 1 operation threshold	17 - 2
With 2 operation thresholds	17 - 3
Toroidal current transformers	17 - 3
External multiplier	17 - 3

Dimensions	17 - 4
-------------------------	---------------

Wiring diagrams	17 - 5
------------------------------	---------------

Technical characteristics	17 - 6
--	---------------

SEC. - PAGE



Page 17-2

FLUSH-MOUNT VERSION

R1D type

- 1 operation threshold
- External toroidal transformer
- Adjustable tripping $I\Delta n$ and delay time.



Page 17-3

FLUSH-MOUNT VERSION

R2D type

- 2 operation thresholds
- External toroidal transformer
- Adjustable tripping $I\Delta n$ and delay time
- Configurable fail safe operation.

R3D type

- 2 operation thresholds
- External toroidal transformer
- Adjustable tripping $I\Delta n$ and delay time
- Configurable fail safe operation
- Flag indicator.



Page 17-3

FLUSH-MOUNT VERSION

R4D type

- 2 operation thresholds
- External toroidal transformer
- Adjustable tripping $I\Delta n$ and delay time
- Configurable fail safe operation
- Fault current measurement
- Digital display
- Flag indicator
- Shunt tripping circuit.



Page 17-2

MODULAR VERSION

RM1 type

- 1 operation threshold
- External toroidal transformer
- Fixed tripping $I\Delta n$ and delay time.

RM type

- 1 operation threshold
- External toroidal transformer
- Adjustable tripping $I\Delta n$ and delay time.



Page 17-2

MODULAR VERSION

RMT type

- 1 operation threshold
- Incorporated toroidal transformer
- Adjustable tripping $I\Delta n$ and delay time.



Page 17-2

COMPACT PANEL MOUNT VERSION

RC type

- 1 operation threshold
- Incorporated toroidal transformer
- Adjustable tripping $I\Delta n$ and delay time
- 35mm to 110mm diameter.



Page 17-3

TOROIDAL CURRENT TRANSFORMERS

RT type

- Solid core
- 35mm to 210mm diameter.

RTA type

- Split core
- 110mm and 210mm diameter.

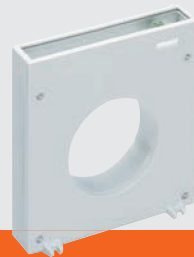

Page 17-3

EXTERNAL MULTIPLIER

RX10 type

- 10-fold multiplier.

Relays with 1 operation threshold



R1D...

Order code	Rated auxiliary supply voltage	Output contacts	Qty per pkg	Wt
	[V]	$\frac{1}{2}$ SPDT	n°	[kg]

1 OPERATION THRESHOLD.
Flush mount. External CT.

R1D48	24-48VAC/DC	1	1	0.280
R1D415	110-240-415V	1	1	0.280

① Supply voltage:
110...125VAC (50/60Hz)/DC
220...240VAC (50/60Hz)
380...415VAC (50/60Hz).

General characteristics

- Earth leakage relay type A
- Green power LED indicator (ON)
- Red relay tripped LED indicator (TRIP)
- Front TEST and RESET buttons
- Configurable automatic or manual resetting
- Flush mount 96x96mm housing with transparent cover
- IEC degree of protection: IP20 terminals, IP40 on front with cover.

ADJUSTMENTS FOR R1D

- Configurable tripping set-point ($I_{\Delta n}$): 0.025...0.25A
0.25...2.5A
2.5...25A
25...250A (with external multiplier 31RX10)
- Configurable tripping delay time (t): 0.02...0.5s
0.2...5s.

Certification and compliance

Certification obtained: EAC.
Compliant with standards: IEC/EN/BS 60947-2.



RM1...

Order code	Rated auxiliary supply voltage	Output contacts	Qty per pkg	Wt
	[V]	$\frac{1}{2}$ SPDT	n°	[kg]

1 OPERATION THRESHOLD.
Modular, 35mm DIN (IEC/EN/BS 60715) rail mounting.
External CT. Fixed tripping set point and time.

RM148	24-48VAC/DC	1	1	0.175
RM1415	110-240-415V	1	1	0.175

1 OPERATION THRESHOLD.
Modular, 35mm DIN (IEC/EN/BS 60715) rail mounting.
External CT.

31RM48	24-48VAC/DC	1	1	0.190
31RM415	110-240-415V	1	1	0.190

1 OPERATION THRESHOLD.
Modular, 35mm DIN (IEC/EN/BS 60715) rail mounting.
 $\varnothing 28\text{mm}/\varnothing 1.1''$ incorporated CT. Configurable fail safe.

31RMT415	110-240-415V	2	1	0.375
-----------------	--------------	---	---	-------

① Supply voltage:
110...125VAC (50/60Hz)/DC
220...240VAC (50/60Hz)
380...415VAC (50/60Hz).

General characteristics

- Earth leakage relay type A
- Configurable fail safe operation for RMT type only
- Green power LED indicator (ON)
- Red relay tripped LED indicator (TRIP)
- Front TEST and RESET buttons
- Configurable automatic or manual resetting
- Modular DIN 43880 housing, 2 modules, with transparent cover, suitable for fixing on 35mm DIN rail (IEC/EN/BS 60715)
- IEC degree of protection: IP20 terminals, IP40 on front with cover.

SETTINGS FOR RM1

- Selectable tripping set-point ($I_{\Delta n}$): fixed 0.3A or 0.5A
- Selectable tripping time (t): fixed 0.02s or 0.5s.

ADJUSTMENTS FOR 31RM AND 31RMT

- Configurable tripping set-point ($I_{\Delta n}$): 0.025...0.25A
0.25...2.5A
2.5...25A
25...250A (with external multiplier 31RX10 for RM only)
- Configurable tripping delay time (t): 0.02...0.5s
0.2...5s.

Certification and compliance

Certification obtained: EAC.
Compliant with standards: IEC/EN/BS 60947-2.



31RM...



31RMT...



31RC60...

Order code	Rated auxiliary supply voltage	Output contacts	Qty per pkg	Wt
	[V]	$\frac{1}{2}$ SPDT	n°	[kg]

1 OPERATION THRESHOLD.
Compact panel mount. CT incorporated.

31RC@48	24-48VAC/DC	1	1	0.485
31RC@415	110-240-415V	1	1	0.485

① Supply voltage:
110...125VAC (50/60Hz)/DC
220...240VAC (50/60Hz)
380...415VAC (50/60Hz).
② Replace with the digit of the required diameter (35-60-80-110mm/
1.38-2.36-3.15-4.33").

General characteristics

- Earth leakage relay type A
- Green power LED indicator (ON)
- Red relay tripped LED indicator (TRIP)
- Front TEST and RESET buttons
- Configurable automatic or manual resetting
- Compact housing for fixing on panel mounting plate
- IEC degree of protection: IP20 terminals.

ADJUSTMENTS FOR RC

- Configurable tripping set-point ($I_{\Delta n}$): 0.025...0.25A
0.25...2.5A
2.5...25A
- Configurable tripping delay time (t): 0.02...0.5s
0.2...5s.

Certification and compliance

Certification obtained: EAC.
Compliant with standards: IEC/EN/BS 60947-2.



31RC110...

Relays with 2 operation thresholds



R2D...



R3D...



R4D...

Ordering code	Rated auxiliary supply voltage	Output contacts	Qty per pkg	Wt
	[V]	2 SPDT	n°	[kg]

2 OPERATION THRESHOLDS.
Flush mount. External CT. Fail safe.

R2D415	110-240-415V	2	1	0.395
---------------	--------------	---	---	-------

2 OPERATION THRESHOLDS.
Flush mount. External CT. Fail safe. Flag Indicator.

R3D415	110-240-415V	2	1	0.405
---------------	--------------	---	---	-------

2 OPERATION THRESHOLDS.
Flush mount. External CT. Fault current measurement. Digital display. Fail safe. Flag indicator.

R4D415	110-240-415V	2	1	0.570
---------------	--------------	---	---	-------

Supply voltage:
110...125VAC (50/60Hz)
220...240VAC (50/60Hz)
380...415VAC (50/60Hz).

General characteristics

- Earth leakage relay type A
- 2 output relays each with changeover contact, configurable as 2 tripping or 1 tripping and 1 alarm
- Configurable fail safe pre-alarm and operation
- Automatic toroid connection control
- Green power LED indicator (ON)
- Red relay tripped LED indicator (TRIP)
- Red tripping pre-alarm LED indicator (ALARM)
- Front TEST button
- Manual resetting by front RESET button or remote contact closing
- Automatic resetting by remote contact closing or rear jumper connection
- Constant toroid-relay circuit control
- Flag indicator (TRIP MEMORY) (R3D-R4D only)
- Digital fault current measurement and display with configurable tripping value memory (R4D only)
- Shunt tripping circuit operating test (TCS) (R4D only)
- Flush mount 96x96mm/3.78"x3.78" housing with transparent cover
- IEC degree of protection: IP20 terminals, IP40 on front with cover.

ADJUSTMENTS FOR R2D and R3D

- Configurable tripping set-point (I_{Δn}): 0.025...0.25A
2.5...25A
25...250A (with external multiplier 31RX10)
- Pre-alarm set-point: fixed 70%
- Configurable tripping delay time (t): 0.02...0.5s
0.2...5s.

ADJUSTMENTS FOR R4D

- Configurable tripping set-point (I_{Δn}): 0.03...0.3A
0.3...3A
3...30A
30...300A (with external multiplier 31RX10)
- Pre-alarm set-point: fixed 70%
- Configurable tripping delay time (t): 0.03...0.5s
0.3...5s.

Certification and compliance

Certification obtained: EAC.
Compliant with standards: IEC/EN/BS 60947-2.

Toroidal current transformers



31RT...



31RT...

Order code	Diameter	Openable	Qty per pkg	Wt.
	[mm/in]		n°	[kg]
31RT35	35/1.38"	No	1	0.200
31RT60	60/2.36"	No	1	0.245
31RT80	80/3.15"	No	1	0.410
31RT110	110/4.33"	No	1	0.400
31RT210	210/8.27"	No	1	1.200
31RTA110	110/4.33"	Yes	1	0.540
31RTA210	210/8.27"	Yes	1	1.820

Certification and compliance

Certification obtained: EAC.
Compliant with standards: IEC/EN/BS 60947-2.

External multiplier



31RX10

Order code	Description	Qty per pkg	Wt
		n°	[kg]
31RX10	10-fold multiplier suitable for R1D, RM, R2D, R3D and R4D types only	1	0.300

General characteristics

- To connect between toroid and relay.

Certification and compliance

Certification obtained: EAC.
Compliant with standards: IEC/EN/BS 60947-2.

17 Earth leakage relays

Dimensions [mm (in)]

EARTH LEAKAGE RELAYS

R1D - R2D - R3D

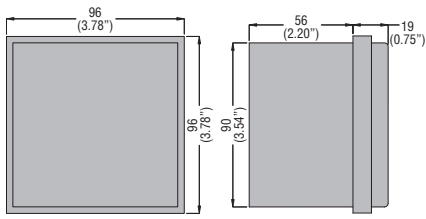

R4D

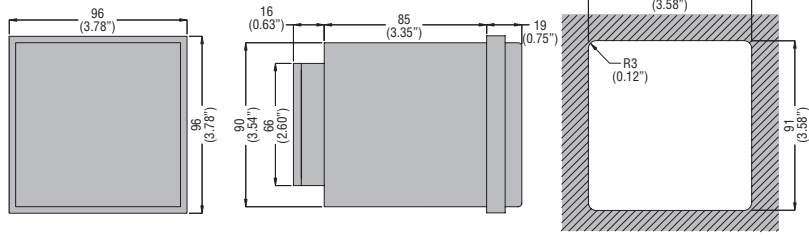

RM1 - 31RM

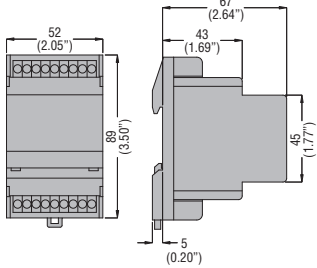

31RMT

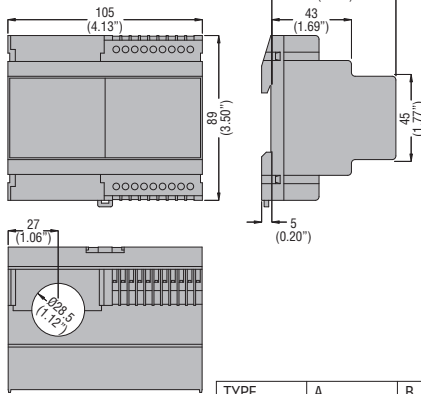

31RC

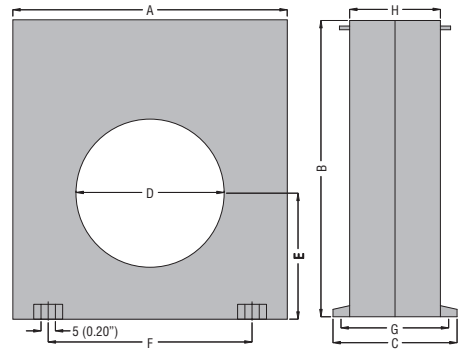

TYPE	A	B	C	D	E	F	G	H
31RC35	100 (3.94")	110 (4.33")	70 (2.75")	35 (1.38")	47 (1.85")	60 (2.36")	60 (2.36")	50 (1.97")
31RC60	100 (3.94")	110 (4.33")	70 (2.75")	60 (2.36")	47 (1.85")	60 (2.36")	60 (2.36")	50 (1.97")
31RC80	150 (5.90")	160 (6.30")	70 (2.75")	80 (3.15")	70 (2.75")	110 (4.33")	60 (2.36")	50 (1.97")
31RC110	150 (5.90")	160 (6.30")	70 (2.75")	110 (4.33")	70 (2.75")	110 (4.33")	60 (2.36")	50 (1.97")

TOROIDAL CURRENT TRANSFORMERS AND EXTERNAL MULTIPLIER

31RT35 - 31RT60 - 31RT80 - 31RT110 - 31RX10

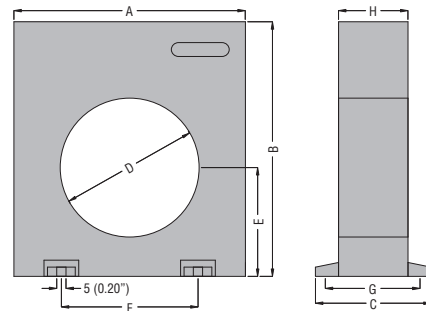

31RT210 - 31RTA210

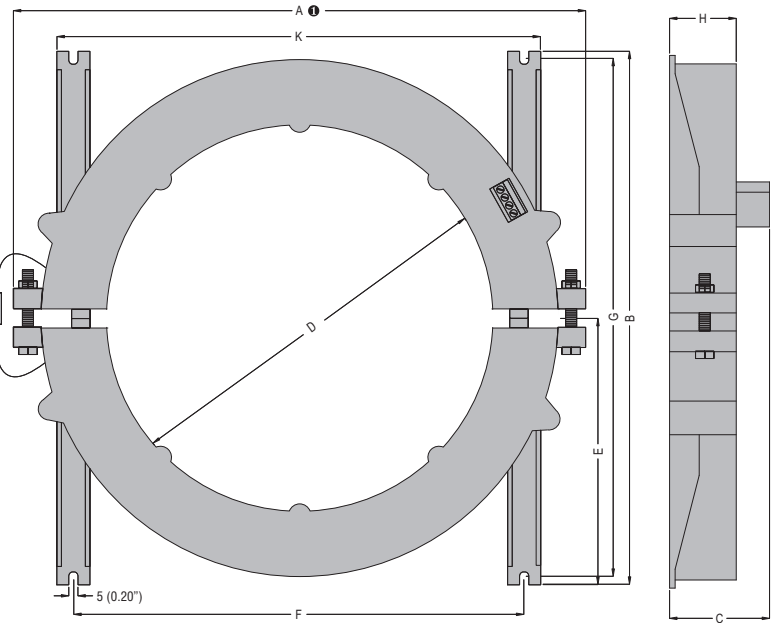

● With screws, for 31RTA210 split-core type; fixed structure, without screws, for 31RT210 type.

31RTA110

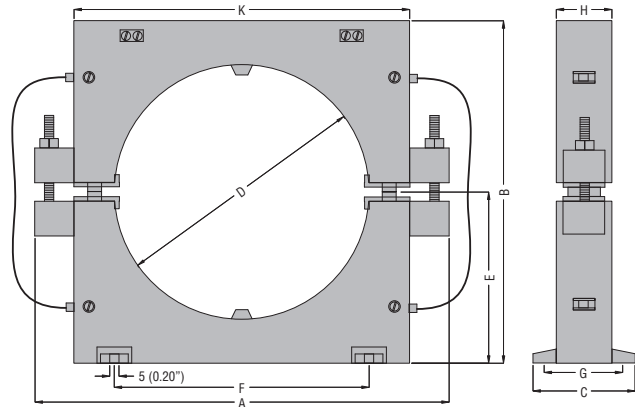

TYPE	A	B	C	D	E	F	G	H	K
31RT35	100 (3.94")	110 (4.33")	50 (1.97")	35 (1.38")	47 (1.85")	60 (2.36")	43 (1.69")	30 (1.18")	—
31RT60	100 (3.94")	110 (4.33")	50 (1.97")	60 (2.36")	47 (1.85")	60 (2.36")	43 (1.69")	30 (1.18")	—
31RT80	150 (5.90")	160 (6.30")	50 (1.97")	80 (3.15")	70 (2.75")	110 (4.33")	43 (1.69")	30 (1.18")	—
31RT110	150 (5.90")	160 (6.30")	50 (1.97")	110 (4.33")	70 (2.75")	110 (4.33")	43 (1.69")	30 (1.18")	—
31RT210	310 (12.20")	290 (11.41")	54 (2.12")	210 (8.27")	145 (5.71")	240 (9.45")	280 (11.02")	36 (1.42")	258 (10.16")
31RTA110	180 (7.09")	150 (5.90")	45 (1.77")	110 (4.33")	75 (2.95")	110 (4.33")	38 (1.50")	25 (0.98")	145 (5.71")
31RTA210	310 (12.20")	290 (11.41")	54 (2.12")	210 (8.27")	145 (5.71")	240 (9.45")	280 (11.02")	36 (1.42")	258 (10.16")
31RX10	100 (3.94")	110 (4.33")	50 (1.97")	—	—	60 (2.36")	43 (1.69")	30 (1.18")	—

EARTH LEAKAGE RELAYS

R1D

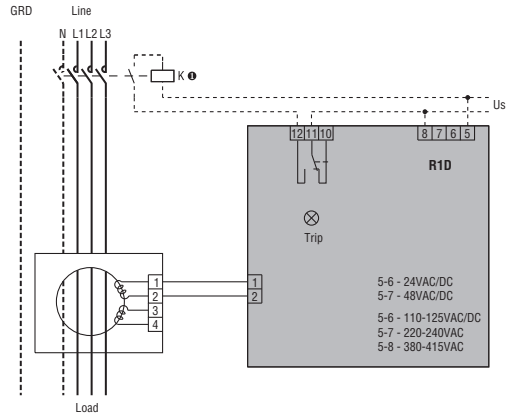

R2D

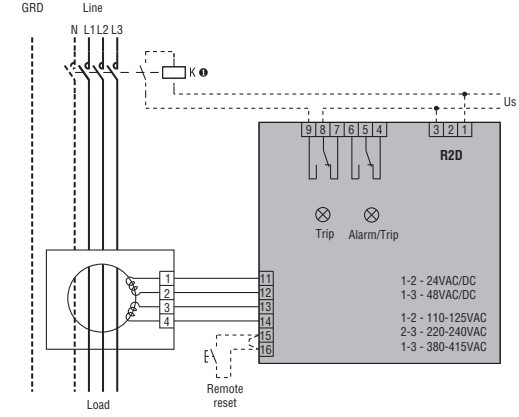

ⓘ The coil connection can vary depending on the connected type of device (contactor, breaker with shunt trip release or breaker with undervoltage trip release).

R3D

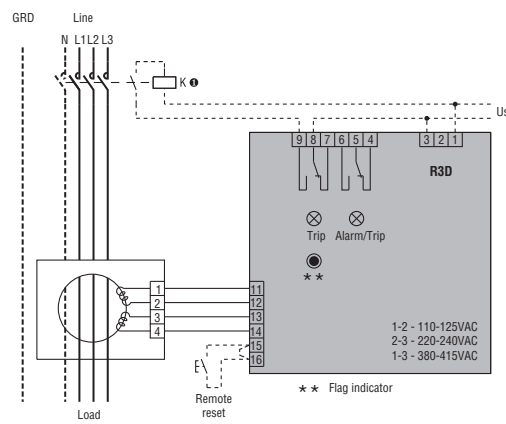

ⓘ The coil connection can vary depending on the connected type of device (contactor, breaker with shunt trip release or breaker with undervoltage trip release).

R4D

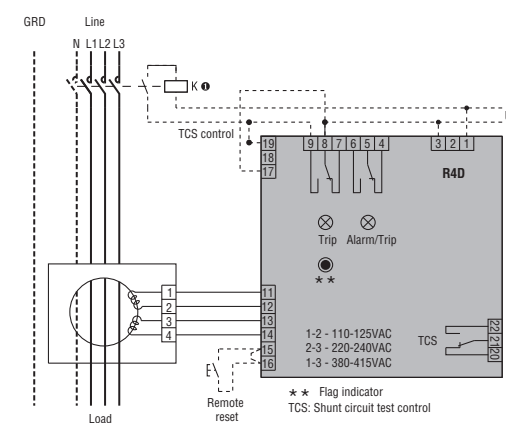

Type	Us	Us Wiring	TCS Wiring
R4D415	110-125VAC	1-2	17-18
	220-240VAC	2-3	17-18
	380-415VAC	1-3	17-19

RM1 - 31RM

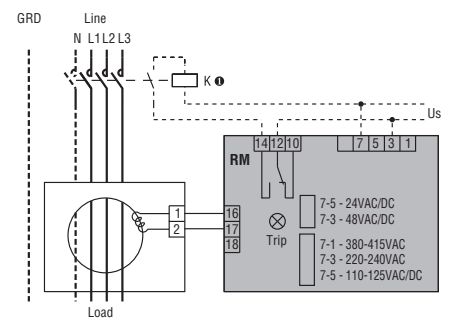

ⓘ The coil connection can vary depending on the connected type of device (contactor, breaker with shunt trip release or breaker with undervoltage trip release).

31RMT

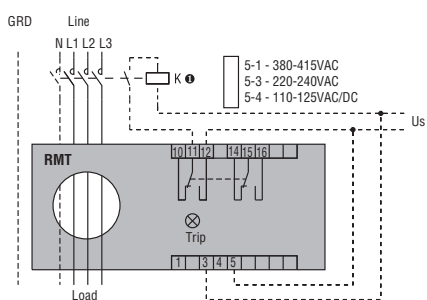

31RC

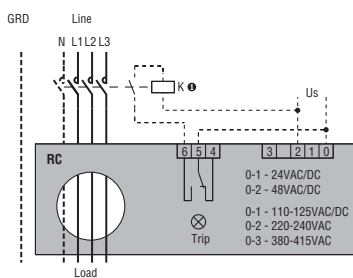

ⓘ The coil connection can vary depending on the connected type of device (contactor, breaker with shunt trip release or breaker with undervoltage trip release).

17 Earth leakage relays

Technical characteristics

TYPE	R1D ^①	R2D ^①	R3D ^①	R4D ^{①②③}
DESCRIPTION				
	Flush mount with transparent cover, 1 operating threshold	Flush mount with transparent cover, 2 operating thresholds constant toroid-relay circuit control	Flush mount with transparent cover, 2 operating thresholds constant toroid-relay circuit control	Flush mount with display and cover, 2 operating thresholds - constant toroid-relay circuit control
CONTROL CIRCUIT				
Toroidal transformer	External (see types given on page 17-3)			
Adjustments				
Tripping set-point (I Δ n)	0.025...0.25A (x0.1) 0.25...2.5A (x1) 2.5...25A (x10) 25...250A (external multiplier)		0.03...0.3A (x0.1) 0.3...3A (x1) 3...30A (x10) 30...300A (external multiplier)	
Prealarm set-point	—	70% I Δ n (fixed)	70% I Δ n (fixed)	70% I Δ n (fixed)
Tripping delay time (t)	0.02...0.5s (tx1) 0.2...5s (tx10)		0.03...0.5s (tx1) 0.3...5s (tx10)	
Selection of multiplier for I Δ n and t	By dip-switches			
Resetting	Configurable automatic or manual by button on front ^②	Automatic by remote contact closing or rear jumper connection Manual by button on front or remote contact closing		
Shunt circuit control	—	—	—	Yes
AUXILIARY SUPPLY				
Auxiliary voltage U _s (0.85 - 1.1 U _s limit)	24-48VAC/DC 110...125VAC/DC 220...240/380...415VAC	— 110...125/220...240/380...415VAC		
Rated frequency	50...60Hz			
Power consumption (maximum)	4VA			
RELAY OUTPUTS				
State	Normally de-energised	Configurable normally de-energised or energised	Configurable normally de-energised or energised	Configurable normally de-energised or energised
Contact arrangement	1 changeover SPDT (trip)	2 changeover SPDT each (configurable: 2 trip or 1 trip and 1 alarm)		
Rated contact capacity IEC I _{th}	5A 250VAC			
Electrical life	3 x 10 ⁵ cycles			
Mechanical life	50 x 10 ⁶ cycles			
INSULATION				
Power frequency withstand voltage	2.5kV for 60s			
INDICATIONS				
Auxiliary voltage available (ON)	Green LED			
Relay tripping (TRIP)	Red LED			
Trip prealarm (ALARM)	—	Red LED	Red LED	Red LED
Mechanical (TRIP MEMORY)	—	—	Flag indicator	Flag indicator
Shunt circuit tripping (TCS)	—	—	—	Red LED
CONNECTIONS				
Type of terminals	Fixed		Removable, plug-in	
Tightening torque maximum	0.5Nm (4.5lb.in)			
Conductor section min...max	0.2...2.5mm ² (24...12AWG)			
AMBIENT CONDITIONS				
Operating temperature	-10...+60°C			
Storage temperature	-20...+80°C			
Relative humidity	≤90%			
HOUSING				
Material	Self-extinguishing polycarbonate			

① Type A, sensitive to residual sinusoidal AC and pulsating DC currents.

② Remote resetting by removing power for more than 1 second.

③ Digital display of fault current measurement and tripping value memory.

17 Earth leakage relays

Technical characteristics

	RM1... ^①	31RM... ^①	31RMT... ^①	31RC... ^①
	Modular with transparent cover, 1 operating threshold	Modular with transparent cover, 1 operating threshold	Modular with transparent cover, 1 operating threshold	Compact, 1 operating threshold
	External (see types given on page 17-3)	External (see types given on page 17-3)	Incorporated Ø28mm/1.1"	Incorporated 35-60-80-110mm/ 1.38-2.36-3.15-4.33" standard diameter
	0.3A or 0.5A	0.025...0.25A (x0.1) 0.25...2.5A (x1) 2.5...25A (x10) 25...250A (external multiplier)	0.025...0.25A (x0.1) 0.25...2.5A (x1) 2.5...25A (x10)	0.025...0.25A (x0.1) 0.25...2.5A (x1) 2.5...25A (x10)
	—	—	—	—
	0.02s or 0.5s	0.02...0.5s (tx1) 0.2...5s (tx10)	0.02...0.5s (tx1) 0.2...5s (tx10)	0.02...0.5s (tx1) 0.2...5s (tx10)
	By dip-switches			
	Configurable A: Automatic or M: Manual by button on front			
	—			
	24-48VAC/DC		—	24-48VAC/DC
	110...125VAC/DC 220...240/380...415VAC			
	50...60Hz			
	3VA			
	Normally de-energised	Normally de-energised	Configurable normally de-energised or energised	Normally de-energised
	1 changeover SPDT (trip)	1 changeover SPDT (trip)	2 changeover SPDT each (both trip)	1 changeover SPDT (trip)
	5A - 250VAC			
	3x10 ⁵ cycles			
	50x10 ⁶ cycles			
	2.5kV for 60s			
	Green LED			
	Red LED			
	—			
	—			
	—			
	Fixed			
	0.5Nm (4.5lb.in)			
	0.2...2.5mm ² (24...12AWG)			
	-10...+60°C			
	-20...+80°C			
	≤90%			
	Self-extinguishing polycarbonate			

^① Type A, sensitive to residual sinusoidal AC and pulsating DC currents.



- Modular versions for modular-slot switchboards, mounting on 35mm DIN rail (IEC/EN/BS 60715) or screw fixing via pull out tabs
- Plug-in or flush-mount version
- Version programmable with NFC and APP
- Wide range of functions and time scales
- High accuracy and repeatability of the time settings.

	SEC. - PAGE
Modular versions	
On delay. Multiscale. Multivoltage	18 - 2
Multifunction. Multiscale. Multivoltage. 1 relay output	18 - 2
Multifunction. Multiscale. Multivoltage. 1 relay output, with NFC and APP	18 - 2
Multifunction. Multiscale. Multivoltage. 2 relay outputs	18 - 3
Recycle, independent timings. Multiscale. Multivoltage	18 - 3
Off delay. Multiscale. Multivoltage	18 - 3
For starting. Multiscale. Multivoltage	18 - 4
For staircase with "zero crossing" load switching	18 - 4
Plug-in and flush-mount version, 48x48mm/1.9x1.9"	
On delay. Multiscale. Multivoltage	18 - 5
On delay. Multiscale. Single voltage	18 - 5
Multifunction. Multivoltage. Multiscale	18 - 5
Accessories	18 - 5
Dimensions	18 - 6
Wiring diagrams	18 - 6
Technical characteristics	18 - 10



Page 18-2

MODULAR TIME RELAYS

- Suitable for modular-slot switchboards
- Selectable time ranges and functions with potentiometers on front or via NFC and APP
- LED indication
- Mounting on 35mm DIN rail or screw fixing
- Screw terminals.



Page 18-5

PLUG-IN AND FLUSH-MOUNT TIME RELAYS, 48X48MM

- Flush and internal panel mounting
- Time ranges: 0.05s...10h
- LED indication
- 8 and 11-pin sockets for panel mounting.

**On delay time relay.
Multiscale. Multivoltage**



TMP

Order code	Time of scale range	Rated auxiliary supply voltage	Qty per pkg	Wt
		[V]	n°	[kg]
TMP	0.1...1s 1...10s 6...60s 1...10min 6min...1h 1...10h 0.1...1 day 1...10 days ON only OFF only	24...48VDC 24...240VAC	1	0.078
TMPA440	0.1...1s 1...10s 6...60s 1...10min	380...440VAC	1	0.078

General characteristics

- Electronic time relay, multiscale, multivoltage. On delay, delay on make, with 1 relay output with 1 changeover contact (SPDT) start at relay energising for TMP
- Electronic time relay, multiscale with 2 normally open (N/O-SPST) contacts with common pole for TMPA440.
- Delay time adjustable on front by rotary switch: 10...100%
- Green LED indicator for power on
- Red LED indicator for relay state; flashing for delay and steady when relay energised
- Modular DIN 43880 housing, 1 module suitable for fixing on 35mm DIN rail (IEC/EN/BS 60715) or screw fixing
- IEC degree of protection: IP40 on front (only when mounted in housing or electric board with IP40); IP20 on terminals.

Certifications and compliance

Certifications obtained: EAC; UL Listed, for USA and Canada (cULus - File E93601), CCC.
Compliant with standards: IEC/EN/BS 61812-1, UL508, CSA C22.2 n° 14.

**Multifunction time relay.
Multiscale. Multivoltage.
1 relay output**



TMM1

Order code	Time of scale range	Rated auxiliary supply voltage	Qty per pkg	Wt
		[V]	n°	[kg]
TMM1	0.1...1s 1...10s 6...60s 1...10min 6min...1h 1...10h 0.1...1 day 1...10 days ON only OFF only	12...240V AC/DC	1	0.086

General characteristics

- Electronic time relay, multifunction, multiscale, multivoltage, with 1 relay output with 1 changeover contact (SPDT)
- Enabling input
- Selectable functions: (a) On delay. (b) Pulse on relay energising with start when energised. (c) Symmetrical flasher starting with OFF. (d) Symmetrical flasher starting with ON. (e) Off delay; relay energising at external contact closing with start on break. (f) Pulse on relay energising with start on external contact closing. (g) Pulse on relay energising with start on external contact opening. (h) On-off delay. Delay on make, with start at external contact closing, and delay at break, with start at external contact opening. (i) Internal ON/OFF trigger with relay contact closing or operating at each closing of an external contact. (j) Pulse generator.
- Delay time adjustable on front by rotary switch: 10...100%
- Green LED indicator for power on
- Red LED indicator for relay state; flashing for delay and steady when relay energised
- Modular DIN 43880 housing, 1 module suitable for fixing on 35mm DIN rail (IEC/EN/BS 60715) or screw fixing
- IEC degree of protection: IP40 on front (only when mounted in housing or electric board with IP40); IP20 on terminals.

Certifications and compliance

Certifications obtained: UL Listed, for USA and Canada (cULus - File E93601); EAC.
Compliant with standards: IEC/EN/BS 61812-1, UL508, CSA C22.2 n° 14.

**Multifunction time relay.
Multiscale. Multivoltage.
1 relay output.
Programmable
with NFC and APP**



TMM1NFC



The app can be downloaded from Google Play Store and App Store.



Order code	Time of scale range	Rated auxiliary supply voltage	Qty per pkg	Wt
		[V]	n°	[kg]
TMM1NFC	0.1s... 999days ON only OFF only	12...240V AC/DC	1	0.086

Simple and intuitive programming with LOVATO **NFC** App thanks to the graphic interface that displays the selected function and parameters directly on the screen of the smartphone, eliminating the need to consult the manual.

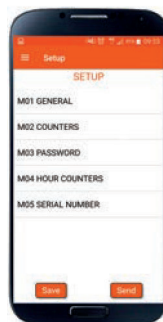
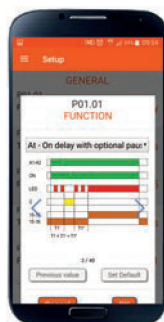

General characteristics

- Electronic time relay, multifunction, multiscale, multivoltage, with 1 relay output with changeover contact (SPDT), with NFC technology and LOVATO **NFC** App
- Command input for the enabling of the function or to pause the timing
- 40 selectable functions. For details consult the technical manual on the website www.LovatoElectric.com
- NFC connectivity for the programming of the parameters with the LOVATO **NFC** App freely downloadable from Google Play Store and App Store
- Simple, fast and intuitive programming
- Very high accuracy and repeatability of the settings
- Internal counter which stops the function when the relay output reaches a programmable number of closures
- Possibility to save the program on smartphone or tablet to be copied on others TMM1NFC, even with device powered off
- Possibility to protect the settings with a password
- QR code for the direct connection to the LOVATO Electric website for the download of the technical manual
- Green LED indicator for power on
- Red LED indicator for relay state; flashing for delay and steady when relay energised
- Modular DIN 43880 housing (1 module), suitable for fixing on 35mm DIN rail (IEC/EN/BS 60715) or screw fixing
- IEC degree of protection: IP40 on front (only when mounted in housing or electric board with IP40), IP20 on terminals.

Certifications and compliance

Certifications: cULus, EAC, CCC.
Compliant with standards: IEC/EN/BS 61812-1, UL508, CSA C22.2 n°14.

Multifunction time relay. Multiscale. Multivoltage. 2 relay outputs



TMM2

Order code	Time of scale range	Rated auxiliary supply voltage	Qty per pkg	Wt
		[V]	n°	[kg]
TMM2	0.1...1s 1...10s 6...60s 1...10min 6min...1h 1...10h 0.1...1 day 1...10 days ON only OFF only	12...240V AC/DC	1	0.094

General characteristics

- Electronic time relay, multifunction, multiscale, multivoltage
- 2 relay outputs, one with 1 delayed changeover (C/O-SPDT) contact and the other with 1 normally open (N/O-SPST) contact, programmable as instantaneous or delayed
- Enabling input
- Selectable functions: (a) On delay; delay on make with start at relay energising. (b) Pulse on relay energising with start when energised. (c) Flasher starting with OFF interval. Equal timing recycle. (d) Flasher starting with ON interval. Equal timing recycle. (e) Off delay; relay energising at external contact closing with start on break. (f) Pulse on relay energising with start on external contact closing. (g) Pulse on relay energising with start on external contact opening. (h) On-off delay. Delay on make, with start at external contact closing, and delay at break, with start at external contact opening. (i) Internal ON/OFF trigger with relay contact closing or operating at each closing of an external contact. (j) Pulse generator, unequal timing recycle; starting with OFF pulse time and 0.5s ON pulse.
- Delay time adjustable on front by rotary switch: 10...100%
- Green LED indicator for power on
- Red LED indicator for relay state; flashing for delay and steady when relay energised
- Modular DIN 43880 housing, 1 module suitable for fixing on 35mm DIN rail (IEC/EN/BS 60715) or screw fixing
- IEC degree of protection: IP40 on front (only when mounted in housing or electric board with IP40); IP20 on terminals.

Certifications and compliance

Certifications obtained: UL Listed, for USA and Canada (cULus - File E93601) as Auxiliary Devices - Timers; EAC. Compliant with standards: IEC/EN/BS 61812-1, UL508, CSA C22.2 n° 14.

Recycle time relay, independent timings. Multiscale. Multivoltage



TMPL

Order code	Time of scale range	Rated auxiliary supply voltage	Qty per pkg	Wt
		[V]	n°	[kg]
TMPL	0.1...1s 1...10s 6...60s 1...10min 6min...1h 1h...10h 0.1...1 day 1...10 days 3...30 days 10...100 days	12...240V AC/DC	1	0.082

General characteristics

- Recycle time relay with asymmetrical timings, multiscale, multivoltage
- 1 relay output with 1 changeover contact (SPDT)
- Enabling input of ON (work) or OFF (pause) interval
- Delay time for OFF (pause) interval, adjustable on front by rotary switch: 10...100%
- Delay time for ON (work) interval, adjustable on front by rotary switch: 10...100%
- Green LED indicator for power on
- Red LED indicator for relay state; flashing for delay
- Modular DIN 43880 housing, 1 module; suitable for fixing on 35mm DIN rail (IEC/EN/BS 60715) or screw fixing
- IEC degree of protection: IP40 on front (only when mounted in housing or electric board with IP40); IP20 on terminals.

Certifications and compliance

Certifications obtained: UL Listed, for USA and Canada (cULus - File E93601) as Auxiliary Devices - Timers; EAC. Compliant with standards: IEC/EN/BS 61812-1, UL508, CSA C22.2 n° 14.

Off delay time relay. Multiscale. Multivoltage



TMD

Order code	Time of scale range	Rated auxiliary supply voltage	Qty per pkg	Wt
		[V]	n°	[kg]
TMD	0.06...0.6s 0.6...6s 6...60s 18...180s	24...240V AC/DC	1	0.080

General characteristics

- Electronic time relay, multiscale, multivoltage. True off delay; delay on break with start at relay de-energising
- 1 relay output with 1 changeover contact (SPDT)
- Delay time adjustable on front by rotary switch: 10...100%
- Green LED indicator for power on
- Modular DIN 43880 housing, 1 module; suitable for fixing on 35mm DIN rail (IEC/EN/BS 60715) or screw fixing
- IEC degree of protection: IP40 on front (only when mounted in housing or electric board with IP40); IP20 on terminals.

Certifications and compliance

Certifications obtained: UL Listed, for USA and Canada (cULus - File E93601) as Auxiliary Devices - Timers; EAC, CCC. Compliant with standards: IEC/EN/BS 61812-1, UL508, CSA C22.2 n° 14.

**Time relay for starting.
Multiscale.
Multivoltage**



TMST

Order code	Time of scale range	Rated auxiliary supply voltage [V]	Qty per pkg n°	Wt [kg]
TMST	0.1...1s 1...10s 6...60s 1...10min	24...48VDC 24...240VAC	1	0.090
TMSTA440	0.1...1s 1...10s 6...60s 1...10min	380...440VAC	1	0.090

General characteristics

- Electronic time relay, multiscale, multivoltage for starting (star-delta, impedance, autotransformer, etc) of induction motors (squirrel cage), 2 separate timings
- 1 relay output with 2 normally open (N/O-SPST) contacts with common pole
- Delay time adjustable on front by rotary switch: 10-100% for star connection
- Starting and transition (20...300ms time scale - from star to delta), time adjustable on front by rotary switch
- Green LED indicator for power on
- Red LED indicator for relay state; flashing during delay and steady at delay lapsing
- Modular DIN 43880 housing, 1 module; suitable for fixing on 35mm DIN rail (IEC/EN/BS 60715) or screw fixing
- IEC degree of protection: IP40 on front (only when mounted in housing or electric board with IP40); IP20 on terminals.

Certifications and compliance

Certifications obtained: UL Listed, for USA and Canada (cULus - File E93601) as Auxiliary Devices - Timers; EAC, CCC. Compliant with standards: IEC/EN/BS 61812-1, UL508, CSA C22.2 n° 14.

Time relay for staircase lighting with "zero crossing" load switching

new



TMLSL

Order code	Time of scale range	Rated auxiliary supply voltage [V]	Qty per pkg n°	Wt [kg]
TMLSL	0.5...20min	220...240VAC	1	0.090

General characteristics

- Electronic time relay for staircase lighting single scale and single voltage
- 1 relay output with 1 powered normally open (N/O-SPST) contact
- Possible connections for 3- or 4-wire systems
- Zero crossing load switching
- Adjustable delay time on the front: 0.5...20min
- Selectable functions:
 - timed lighting + staircase cleaning
 - timed lighting with notice of shutdown + staircase cleaning
 - constant lighting
- Green LED for power presence signalling
- 1 control input can be connected to up to 50 light buttons (<1mA each)
- 1 relay output with normally open contact NO, 16A 250VAC
- LED lamp management up to 600W
- QR code for the direct connection to the LOVATO Electric website for the download of the technical manual
- Modular housing DIN 43880 (1 module), suitable for fixing on 35mm omega profile or screw fixing
- Degree of protection: IP40 on front (if mounted in container and/or electrical panel having IP40), IP20 on terminals.

Certifications and compliance

Certifications obtained: EAC. Compliant with standards: IEC/EN/BS 61812-1, UL508, CSA C22.2 n°14.

"ZERO CROSSING" LOAD SWITCHING - IDEAL FOR LED LAMPS

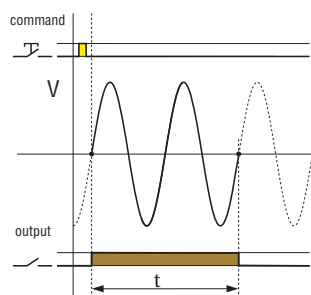

The time relay for staircase TMLSL uses "zero crossing" technology for load switching, which consists in monitoring the sinusoidal mains voltage and inserting the load at the exact instant in which the voltage passes through zero.

This has several advantages:

- reduction of the inrush current generated when the lamp is activated, which can reach very high values, especially in the increasingly popular LED lamps
- protection of the lamp and extension of the electrical life
- protection of the time relay contact from the risk of sticking
- reduction of consumption.



18 Time relays

Plug-in and flush mount version 48x48mm/1.9x1.9"
Accessories

Time relay



31L48TP...



31L48TPB...



31L48M...

Accessories for 48x48mm/1.9x1.9" time relay



HR7XS1



31L48P8



HR7XS2



31L48P11



31L48AP

Order code	Time scale range	Rated auxiliary supply voltage	Qty per pkg	Wt
		[V]	n°	[kg]
Time relay on delay. Multiscale and multivoltage.				
31L48TPS240	0.3...780s	24VAC/DC 110VAC	1	0.124
31L48TPM240	18s...780min	220...240VAC	1	0.124
Time relay on delay. Multiscale and single voltage.				
31L48TPBM24	0.05s...10min	24VAC/DC	1	0.124
31L48TPBM240		220...240VAC	1	0.124
Time relay, multifunction, multivoltage and multiscale.				
31L48MM240	0.05s...10min	24...240V AC/DC	1	0.135
31L48MH240	0.05min...10h		1	0.135

Order code	Description	Qty per pkg	Wt
		n°	[kg]
HR7XS1	8-pin socket for screw fixing or on 35mm DIN rail (IEC/EN/BS 60715) of time relay type L48T....	10	0.061
31L48P8	8-pin socket for the door-mounting of time relay type 31L48T... with accessory 31L48AP. Screw terminals.	10	0.040
HR7XS2	11-pin socket for screw fixing or on 35mm DIN rail (IEC/EN/BS 60715) of time relay type 31L48M....	10	0.064
31L48P11	11-pin socket for the door-mounting of time relay type L48M... with accessory 31L48AP. Screw terminals.	10	0.048
31L48AP	Flush door mounting bracket	10	0.012

NOTE: max. conductor section for sockets: 2x2.5mm²/2x14AWG. Tightening torque: 0.8Nm/7.1lb.in.

General characteristics

- TIME RELAY 31L48TP...
- Electronic time relay, multiscale, multivoltage.
 - On delay, delay on make with start at relay energising
 - 1 relay output with 1 changeover contact (SPDT)
 - Delay time adjustable on front by rotary knob
 - Time range selected by dip switches:
 - 31L48TPS: 0.3...3s; 1.2...12s; 10...100s; 7.8...780s.
 - 31L48TPM: 18s...3min; 72s...12min; 10...100min; 78...780min
 - LED indicators for power on and relay state
 - Plug-in housing with 8-pin socket, HR7XS1 or 31L48P8 with accessory 31L48AP
 - Flush door-mounting bracket 31L48AP available
 - IEC protection degree: IP40 on front and IP20 at terminals.

Time range setting

	A B	A B	A B	A B
	1 0	1 0	1 0	1 0
31L48TPS	0.3...3s	1.2...12s	10...100s	7.8...780s
31L48TPM	18s...3min	72s...12min	10...100min	78...780min

TIME RELAY 31L48TPB...

- Electronic time relay, multiscale, single voltage, on delay function
- 2 relay outputs, each with 1 changeover contact (SPDT), configurable either delay on make or instantaneous
- Delay time adjustable on front by rotary knob
- Time range selected by dip switches:
 - 0.05...1s; 0.1...10s; 0.6s...1min; 6s...10min
- LED indicators for power on and relay state
- Plug-in housing with 8-pin socket, HR7XS1 or 31L48P8 with accessory 31L48AP
- Flush door-mounting bracket 31L48AP available
- IEC protection degree: IP40 on front and IP20 at terminals.

Time range setting

	A B	A B	A B	A B
	1 0	1 0	1 0	1 0
31L48TPB	0.05...1s	0.1...10s	0.6s...1min	6s...10min

TIME RELAY 31L48M...

- Electronic time relay, multiscale, multivoltage, multifunction
- Selectable functions: On delay, delay on make with start at relay energising. Pulse on relay energising with start on energising. Flasher, starting with OFF interval. Flasher, starting with ON interval. Time relay resetting is possible on closing of external contact (R) connected to terminals 7-6. Possible time relay stopping storing elapsed time on closing of external contact (M) connected to terminals 7-5 and then restarting time on its opening. See diagrams on page 18-9
- 2 relay outputs, each with 1 changeover contact; both delayed (SPDT)
- Delay time adjustable on front by rotary knob
- Time range selected by dip switches:
 - 31L48MM: 0.05...1s; 0.1...10s; 0.6s...1min; 6s...10min
 - 31L48MH: 0.05...1min; 0.1...10min; 0.6min...1h; 1min...10h
- LED indicators for power on and relay state
- Plug-in housing with 11-pin socket, HR7XS2 or 31L48P11 with accessory 31L48AP
- Flush door-mounting bracket 31L48AP available
- IEC protection degree: IP40 on front and IP20 at terminals.

Time range setting

	A B	A B	A B	A B
	1 0	1 0	1 0	1 0
31L48MM	0.05...1s	0.1...10s	0.6s...1min	6s...10min
31L48MH	0.05...1min	0.1...10min	0.6min...1h	1min...10h

SOCKETS HR7X... AND 31L48...

- 8-pin and 11-pin version
- Screw fixing or on DIN rail for HR7X..., flush mount for 31L48... with accessory 31L48AP
- Screw terminals
- Ratings: 10A - 250VAC.

Certifications and compliance

Certifications obtained: cURus (for 31L48... and HR7X... type), CSA (for HR7X... type), EAC. Compliant with standards: IEC/EN/BS 61810-1 (for HR7X... type), IEC/EN/BS 61812-1, UL508, CSA C22.2 n° 14.

TIME RELAYS
TM...

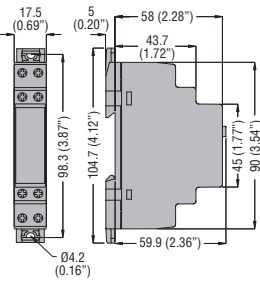

31L48...

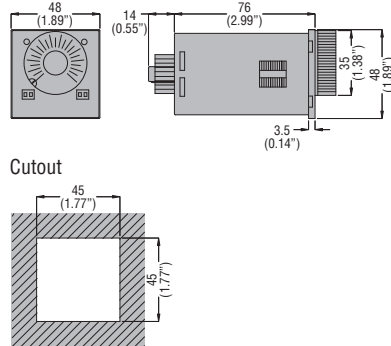

ACCESSORIES - SOCKETS
HR7XS1

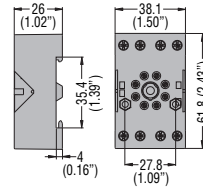

HR7XS2

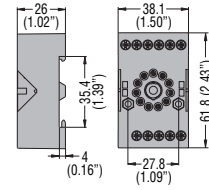

31L48P8

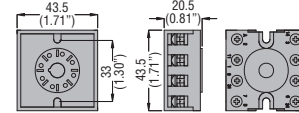

31L48P11

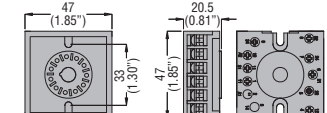

Wiring diagrams

TMP

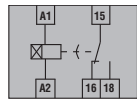

On delay. Delay on make, with start at relay energising

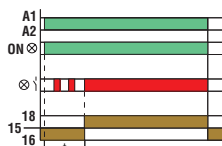

TMPA440

On delay. Delay on make, with start at relay energising

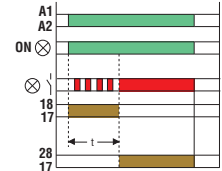
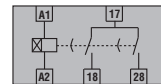

TMM1

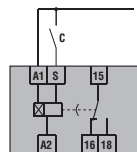

On delay. Delay on make, with start at relay energising



Pulse on relay energising with start at external contact closing

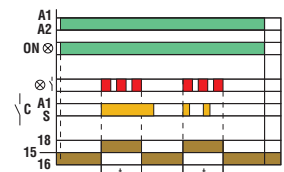

Pulse on relay energising with start on energising



Pulse on relay energising with start at external contact opening

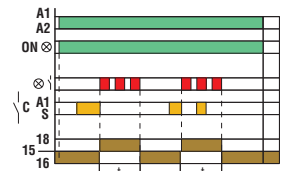

Flasher, starting with OFF (pause) interval. Equal timing recycle



On-Off delay. Delay on make, with start at external contact closing, and delay at break, with start at external contact opening

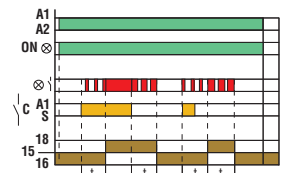

Flasher, starting with ON (work) interval. Equal timing recycle



Internal ON/OFF trigger. Relay contact either closes or opens at each external contact closing

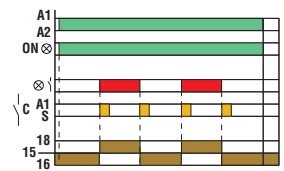

Off delay. Relay energising at external contact closing with start on break



Pulse generator. Unequal timing recycle, starting with OFF pulse time and 0.5sec ON time

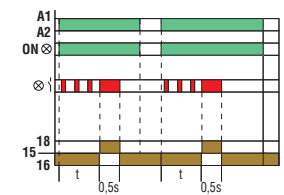

TMM1NFC

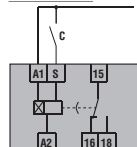

For operational diagrams see instruction manual I562 on the website www.LovatoElectric.com, section download/technical instruction.

TMM2

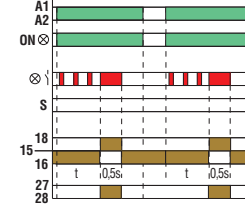
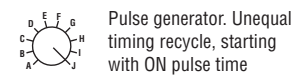
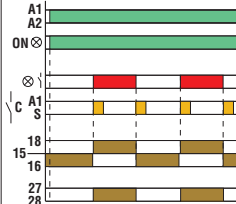
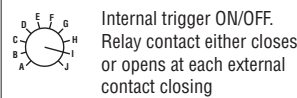
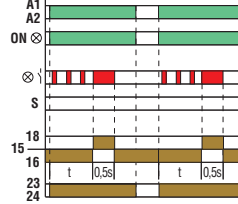
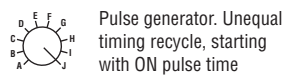
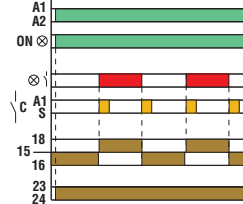
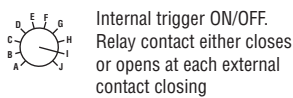
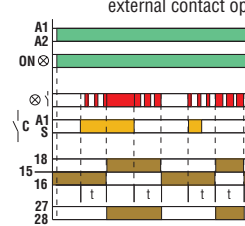
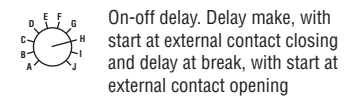
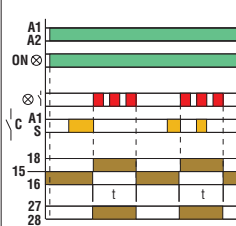
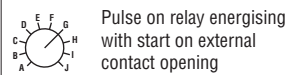
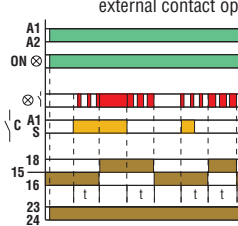
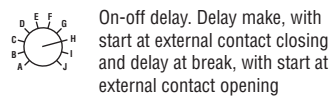
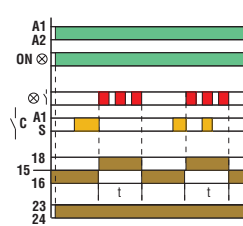
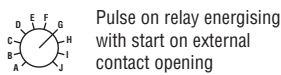
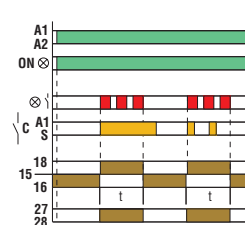
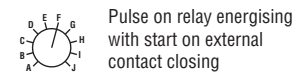
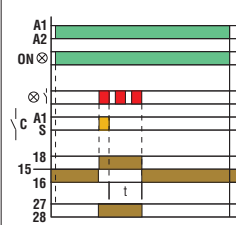
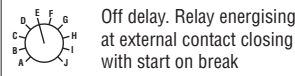
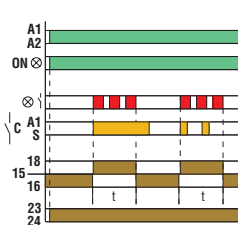
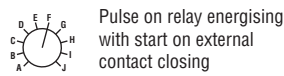
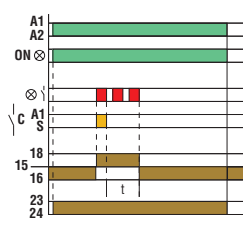
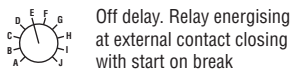
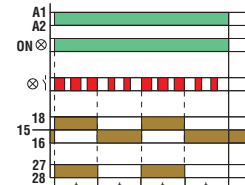
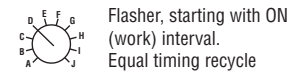
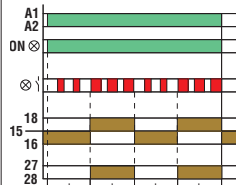
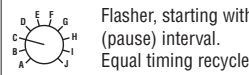
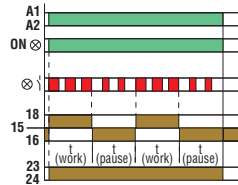
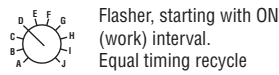
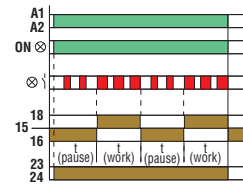
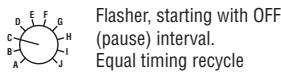
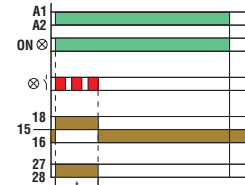
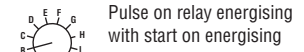
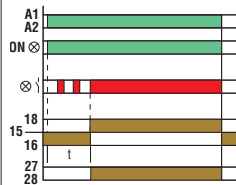
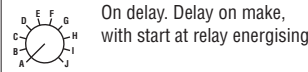
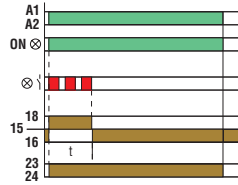
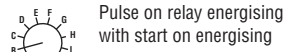
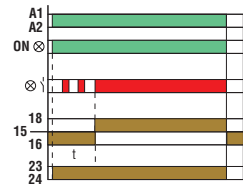
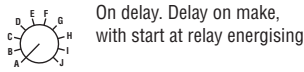
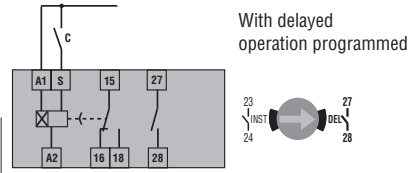
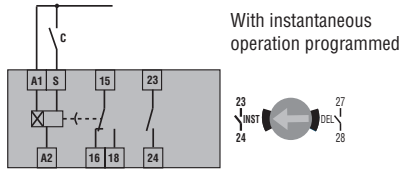

TMPL

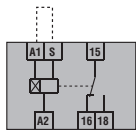

Flasher, starting with ON interval.
Equal timing recycle, ON first

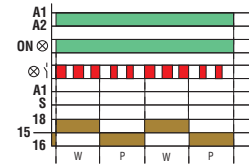

W = Work (ON)
P = Pause (OFF)

Flasher, starting with OFF interval.
Equal timing recycle, OFF first

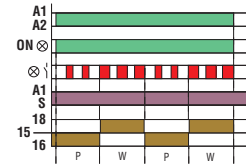

W = Work (ON)
P = Pause (OFF)

TMD

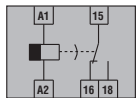

True off delay. Delay on break, starting at relay de-energising

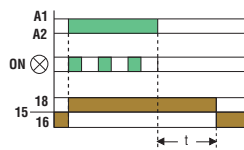

TMST

For starting

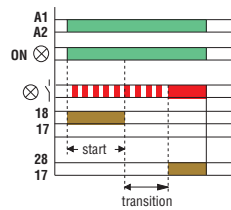
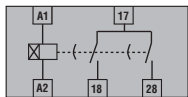

TMLS

4-wire connection

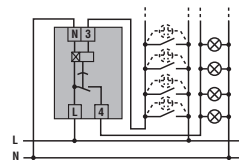

3-wire connection

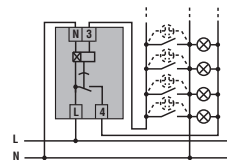

Timed lighting + staircase cleaning

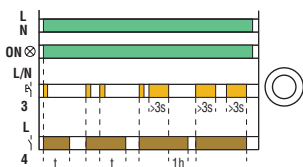

Timed lighting with shutdown notice + staircase cleaning

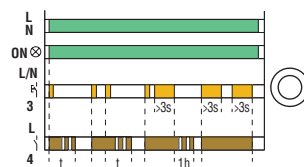

Constant lighting

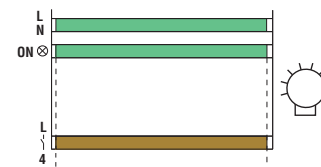

31L48TP...

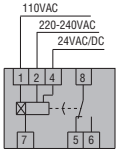

On delay

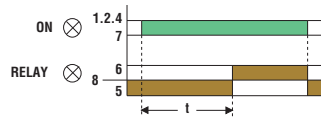

31L48TPB...

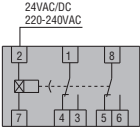

On delay with both instantaneous c/o contacts

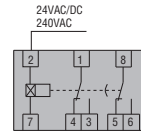
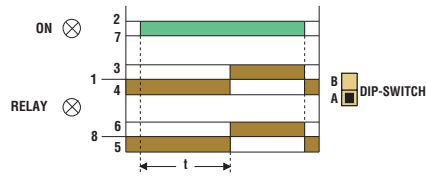

On delay with one instantaneous c/o contact and one late-break c/o contact

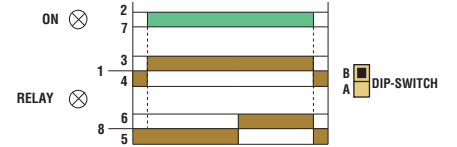

31L48M...

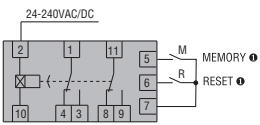

T (preset time) = T1+T2
 ● Contacts "M" and "R" are to be voltage free (dry).

On delay

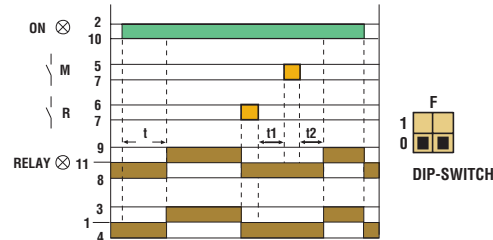

Pulse on relay energising with start on energising

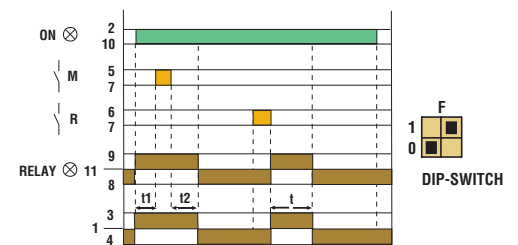

Flasher starting with OFF

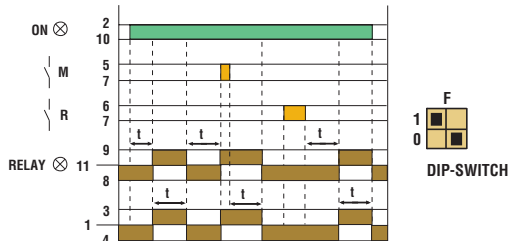

Flasher starting with ON

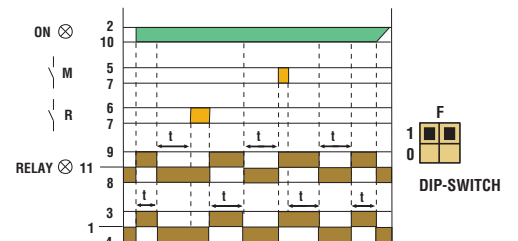

18 Time relays

Technical characteristics
Modular version



INDEX

TYPE	TMP	TMPA440	TMM1 - TMM2	TMM1NFC	TMPL	TMD	TMST	TMLS
DESCRIPTION	On delay	On delay	Programmable multifunction	Programmable multifunction with NFC	Asymmetrical recycle	True off delay	For starting	Staircase illumination
	Multiscale	Multiscale	Multiscale	Multiscale	Multiscale	Multiscale	Multiscale	Single scale
	Multivoltage	Single voltage	Multivoltage	Multivoltage	Multivoltage	Multivoltage	Multivoltage	Single voltage
CONTROL CIRCUIT								
Rated auxiliary supply voltage Us	24...48VDC 24...240VAC	380...440VAC	12...240VAC/DC			24...240VAC/DC	24...48VDC 24...240VAC 380...440VAC	220...240VAC
Rated frequency	50/60Hz							
Operating voltage range	0.85...1.1Us							
Power consumption (maximum)	1.2VA/0.8W max (24...48VAC/DC) 16VA/0.9W max (110...240VAC)	19VA/1.7W max	TM M1: 0.6VA/0.3W max (12...48VAC/DC) 1.6VA/1.2W max (110...240VAC/DC) TM M2: 1.1VA/0.8W max (12...48VAC/DC) 1.8VA/1.2W max (110...240VAC/DC)	0.6VA/0.3W max (12...48VAC/DC) 1.6VA/1.2W max (110...240VAC/DC)	0.6VA/0.3W max (12...48VAC/DC) 1.6VA/1.2W max (110...240VAC/DC)	0.1VA/0.1W (24...48VAC/DC) 1.1VA/0.8W (110...240VAC/DC)	1.2VA/0.8W max (24...48VAC/DC) 1.6VA/0.9W max (110...240VAC/DC)	⊗
TIMING CIRCUIT								
Time setting range	Multiscale 0.1...1s 1...10s 6s...60s 1...10min 6min...1h 1...10h 0.1...1day 1...10days ON only OFF only	Multiscale 0.1...1s 1...10s 6s...60s 1...10min	Multiscale 0.1...1s 1...10s 6s...60s 1...10min 6min...1h 1...10h 0.1...1day 1...10days ON only OFF only	Multiscale 0.1s...999h programmable via NFC and APP	Multiscale 0.1...1s 1...10s 6s...60s 1...10min 6min...1h 1h...10h 0.1...1gg 1...10gg 3...30gg 10...100gg	Multiscale 0.06...0.6s 0.6...6s 6s...60s 18s...180s	Multiscale 0.1...1s 1...10s 6s...60s 1...10min	Single scale 0.5...20min
Setting accuracy	< ±9%		0		< ±9%			⊗
Repeat accuracy	< ±0.1%	< ±0.5%	< ±0.5% - < ±0.2%	< ±0.1%	< ±0.2%	< ±0.5%		⊗
Influence of voltage variation	< ±0.01%							
Average variation of set delays related to +20°C condition	< ±0.2%							
Minimum power time	—	—	—	—	—	≥ 200ms	—	—
Minimum ON time	—	—	25ms (no maximum limit)			—	—	≥ 60ms (no max lim.)
Resetting time	during timing ≥ 100ms	≥ 100ms	≥ 100ms	≥ 100ms	≥ 100ms	—	≥ 100ms	⊗
	elapsed time ≥ 50ms	≥ 50ms	≥ 50ms	≥ 50ms	≥ 50ms	—	≥ 50ms	—
Immunity time for microbreakings	≤ 50ms	—	≤ 25ms - ≤ 15ms	≤ 25ms	≤ 25ms	—	≤ 40ms⊗	⊗
RELAY OUTPUTS								
Contact arrangement	1 delayed changeover	2 delayed changeover	TMM1: 1 delayed changeover TM M2: 1 inst./delayed N/O + 1 delayed c/o	1 delayed changeover	1 delayed changeover	1 delayed changeover	2 delayed N/O	1 delayed N/O
Maximum switching voltage	250VAC							
IEC conventional free air thermal current (Ith)	8A	8A	8A	8A	8A	5A	8A	16A
UL/CSA designation	B300							
Electrical life (with rated load)	10 ⁵ cycles							
Mechanical life	30x10 ⁶ cycles							
Tightening torque maximum	max. 0.8Nm (7lb.in; 7...9lb.in per UL)							
Conductor section min-max	0.2...4mm ² (24...12AWG; 12...18AWG per UL)							
INSULATION (input-output)								
IEC rated insulation voltage	250V							
IEC rated impulse withstand voltage	4kV							
IEC power frequency withstand voltage	2kV							
AMBIENT CONDITIONS								
Operating temperature	-20...+60°C							
Storage temperature	-30...+80°C							
Housing material	Self-extinguishing polyamide							

⊗ For 380...440VAC types: 19VA/1.7W max. ⊗ Used at 24...48VDC or 24...240VAC; ≤30ms at 380...440VAC. ⊗ Consult Technical support for information; see contact details on front cover.
NOTE: N/O = normally open / SPST c/o = changeover / SPDT; inst. = instantaneous.

18 Time relays

Technical characteristics

Plug-in and flush mount version 48x48mm/1.9x1.9"

TYPE	31L48TP...	31L48TPB...	31L48M...
DESCRIPTION			
	On delay	On delay	Programmable multifunction
	Multiscale	Multiscale	Multiscale
	Multivoltage	Single voltage	Multivoltage
CONTROL CIRCUIT			
Rated supply voltage U_s	24VAC/DC❶	24VAC/DC❶	24...240VAC/DC❶
	110VAC❶	220...240VAC❶	
	220...240VAC❶		
Rated frequency	50...60Hz		
Operating voltage range	0.85...1.1 U_s		
Power consumption (maximum)	6VA		
TIMING CIRCUIT			
Time setting range	31L48TPS... Multiscale 0.3...3s 1.2...12s 10...100s 7.8...780s	Multiscale 0.05...1s 0.10...10s 0.6s...1min 6s...10min	31L48MM... Multiscale 0.05...1s 0.1...10s 0.6s...1min 6s...10min
	31L48TPM... 18s...3min 72s...12min 10...100min 78...780min		31L48MH... 0.05...1min 0.1...10min 0.6min...1h 1min...10h
Setting accuracy	±5%		
Repeat accuracy	±0.5%		
Influence of voltage variation	±0.5%		
Average variation of set delays in related to 20°C condition	at -10°C +2%		
	at +60°C -3%		
Minimum ON time	—		
Resetting time	during operation	≥ 0.1s	≥ 0.1s
	elapsed time	≥ 65ms	≥ 65ms
Immunity time for microbreakings	≤ 40ms	≤ 40ms	≤ 40ms
RELAY OUTPUTS			
Number of relays	1	2	2
Contact arrangement	1 delayed c/o	2 del. or 1 inst. + 1 del. c/o	2 delayed c/o
Maximum switching voltage	250V		
IEC conventional free air thermal current (I _{th})	5A		
UL/CSA designation	B300		
Electrical life (with rated load)	10 ⁵ cycles		
Mechanical life	30x10 ⁶ cycles		
CONNECTIONS			
Tightening torque maximum	—		
Conductor section (min-max)	—		
INSULATION (input-output)			
IEC rated insulation voltage U_i	250V		
IEC power frequency withstand voltage U_{imp}	—		
IEC power frequency withstand voltage	2kV		
AMBIENT CONDITIONS			
Operating temperature	-10...+60°C		
Storage temperature	-30...+80°C		
Housing material	Self-extinguishing polyamide		

❶ Other voltages on request.

NOTE: del. = delayed inst. = instantaneous c/o = changeover/SPDT



- Modular versions suitable for different type of installations, DIN rail, screw fixing or switchboard, also suitable for rear mounting plate fixing
- Minimum and maximum voltage monitoring relays for single and three-phase systems, with or without neutral
- Voltage asymmetry, phase sequence and phase loss control relays
- Multifunction voltage and frequency monitoring relays with NFC technology and APP
- Frequency monitoring relays
- Minimum and maximum current monitoring relays
- Interface protection system units compliant with standards CEI 0-21, CEI 0-16, DEWA DRRG, ENA G59-3/G99, VDE-AR-N 4105, VDE V 0126-1-1, SEC (Saudi Electricity Company).

	SEC. - PAGE
Voltage monitoring relays	
For three-phase systems, without neutral	19 - 4
For three-phase systems, with or without neutral	19 - 6
For single-phase systems	19 - 7
Multifunction voltage and frequency monitoring relays, programmable via NFC technology and APP	19 - 8
Frequency monitoring relays	19 - 9
Current monitoring relays	
For single-phase systems	19 - 9
For single and three-phase systems	19 - 10
Pump protection relays	19 - 11
Interface protection system units	19 - 12
Accessories	19 - 16
Dimensions	19 - 17
Wiring diagrams	19 - 18
Technical characteristics	19 - 22



Pages 19-4 to 7

VOLTAGE MONITORING RELAYS

- For three-phase systems with or without neutral and single-phase systems
- Minimum and maximum AC voltage
- Phase loss and incorrect phase sequence
- Asymmetry
- Minimum and maximum frequency.



Page 19-8

MULTIFUNCTION VOLTAGE AND FREQUENCY MONITORING RELAYS

- Voltage and frequency monitoring relays for three-phase systems with or without neutral
- Programmable via NFC technology and APP
- Minimum and maximum AC voltage
- Phase loss, neutral loss and incorrect phase sequence
- Asymmetry
- Minimum and maximum frequency.



Page 19-8

FREQUENCY MONITORING RELAYS

- For single and three-phase systems
- Minimum frequency
- Maximum frequency.



Pages 19-9 and 10

CURRENT MONITORING RELAYS

- For single and three-phase systems
- Maximum AC/DC current
- Minimum or maximum AC/DC current
- Minimum and maximum AC/DC current.



Page 19-11

PUMP PROTECTION RELAYS

- For single and three-phase systems
- Minimum $\cos\phi$ for dry running protection
- Maximum AC current
- Phase loss and incorrect phase sequence.



Page 19-12

INTERFACE PROTECTION SYSTEM UNITS

- Compliant with Italian standard CEI 0-21, for low voltage
- Compliant with Italian standard CEI 0-16, for medium voltage
- Compliant with standard SHAMS DUBAI - DRRG (DEWA)
- Compliant with technical guide SEC (Saudi Electricity Company)
- Compliant with technical guide ENA G59-3/G99
- Compliant with technical guide VDE-AR-N 4105
- Compliant with technical guide VDE V 0126-1-1.

Voltage monitoring relays for three-phase systems without neutral



	PMV10	PMV20	PMV30	PMV40	PMV50	PMV70
Modular version	●(1U)	●(2U)	●(2U)	●(2U)	●(2U)	●(2U)
Minimum AC voltage			●		●	●
Maximum AC voltage					●	●
Phase loss	●	●	●	●	●	●
Incorrect phase sequence	●	●	●	●	●	●
Asymmetry				●		●
Page		19-4			19-5	19-5

Voltage monitoring relays for three-phase systems with or without neutral



	PMV50N	PMV70N	PMV80N	PMV95N
Modular version	●(3U)	●(3U)	●(3U)	●(2U)
Minimum AC voltage	●	●	●	●
Maximum AC voltage	●	●	●	●
Phase loss	●	●	●	●
Neutral loss	●	●	●	●
Incorrect phase sequence	●	●	●	●
Asymmetry		●		●
Minimum frequency			●	●
Maximum frequency			●	●
Programmable via NFC technology and APP				●
Page	19-6	19-6	19-7	19-8

Voltage monitoring relay for single-phase systems



	PMV55
Modular version	●(2U)
Minimum AC voltage	●
Maximum AC voltage	●
Page	19-7

Frequency monitoring relays for single-phase and three-phase systems



	PMF20
Modular version	●(2U)
Minimum frequency	●
Maximum frequency	●
Page	19-9

Current monitoring relays for single and three-phase systems



	PMA20	PMA30	PMA40
Modular version	●(2U)	●(2U)	●(3U)
Maximum AC/DC current	●		
Minimum or maximum AC/DC current		●	
Minimum and maximum AC/DC current			●
Page	19-9		19-10

Pump protection relay for single and three-phase systems



	PMA50
Modular version	●(3U)
Minimum cosφ for dry running pump protection	●
Maximum AC current	●
Phase loss	●
Incorrect phase sequence	●
Page	19-11

Interface protection system units



	PMVF20	PMVF30	PMVF51	PMVF60	PMVF70	PMVF80
CEI 0-21	●		●			
CEI 0-16		●				
DEWA DRRG				●		
SEC (Saudi Electricity Company)				●		
ENA G59-3/G99					●	
VDE-AR-N 4105						●
VDE V 0126-1-1						●
Page	19-12	19-14	19-13	19-15	19-15	19-15

For three-phase systems, without neutral



PMV10A440

PMV20...

Order code	Rated voltage to control Ue (phase-to-phase)	Qty per pkg	Wt
	[V] 50/60Hz	n°	[kg]

Three-phase system, without neutral. Phase loss and incorrect phase sequence. Instantaneous trip. 1 module housing.

PMV10A440	208...480VAC	1	0.050
PMV20A240	100...240VAC	1	0.120
PMV20A575	208...575VAC	1	0.120
PMV20A600	380...600VAC	1	0.120

2 modules housing.



PMV30...

Order code	Rated voltage to control Ue (phase-to-phase)	Qty per pkg	Wt
	[V] 50/60Hz	n°	[kg]

Three-phase system, without neutral. Minimum AC voltage. Delayed trip. Phase loss and incorrect phase sequence. Instantaneous trip.

PMV30A240	208...240VAC	1	0.130
PMV30A575	380...575VAC	1	0.130
PMV30A600	600VAC	1	0.130



PMV40...

Order code	Rated voltage to control Ue (phase-to-phase)	Qty per pkg	Wt
	[V] 50/60Hz	n°	[kg]

Three-phase system, without neutral. Asymmetry. Delayed trip. Phase loss and incorrect phase sequence. Instantaneous trip.

PMV40A240	208...240VAC	1	0.130
PMV40A575	380...575VAC	1	0.130
PMV40A600	600VAC	1	0.130

General characteristics

- Voltage monitoring relay, self powered, for phase loss and incorrect phase sequence
- Phase loss detection if one of the voltages is <70% rated value
- Phase loss tripping time: 60ms
- 1 relay output with 1 changeover contact (SPDT)
- Modular DIN 43880 housing: 1 module for PMV10; 2 modules for PMV20
- Mounting on 35mm DIN rail (IEC/EN/BS 60715) or screw fixing via pull out tabs
- IEC degree of protection: IP40 on front (only when placed in IP40 enclosure or control board); IP20 at terminals.

Certifications and compliance

Certifications obtained: UL Listed, for USA and Canada (cULus - File E93601) as Auxiliary Devices; EAC. Compliant with standards: IEC/EN/BS 60255-27, IEC/EN/BS 61000-6-2, IEC/EN/BS 61000-6-3, UL 508, CSA C22.2 n° 14.

General characteristics

- Voltage monitoring relay, self powered, for minimum voltage, phase loss and incorrect phase sequence
- Configurable rated voltage (Ue):
 - PMV30A240: 208-220-230-240VAC
 - PMV30A575: 380-400-415-440-460-480-525-575VAC
- Excellent tripping accuracy
- TRMS measurements (True Root Mean Square)
- Control of phase-to-phase voltages
- Phase loss detection if one of the voltages is <70% rated value
- Phase loss tripping time: 60ms
- 1 relay output with 1 changeover contact (SPDT)
- Modular DIN 43880 housing, 2 modules
- Mounting on 35mm DIN rail (IEC/EN/BS 60715) or screw fixing via pull out tabs
- IEC degree of protection: IP40 on front (only when placed in IP40 enclosure or control board); IP20 at terminals.

ADJUSTMENTS

- "V min" Minimum voltage tripping threshold
80...95% Ue
- "Delay" Tripping time 0.1...20s
- "Reset delay" Resetting time 0.1...20s.

Certifications and compliance

Certifications obtained: UL Listed, for USA and Canada (cULus - File E93601), as Auxiliary Devices; EAC. Compliant with standards: IEC/EN/BS 60255-27, IEC/EN/BS 61000-6-2, IEC/EN/BS 61000-6-3, UL 508, CSA C22.2 n° 14.

General characteristics

- Voltage monitoring relay, self powered, for asymmetry, phase loss and incorrect phase sequence
- Excellent tripping accuracy
- TRMS measurements (True Root Mean Square)
- Control of phase-to-phase voltages
- Phase loss detection if one of the voltages is <70% rated value
- Phase loss tripping time: 60ms
- 1 relay output with 1 changeover contact (SPDT)
- Modular DIN 43880 housing, 2 modules
- Mounting on 35mm DIN rail (IEC/EN/BS 60715) or screw fixing via pull out tabs
- IEC degree of protection: IP40 on front (only when placed in IP40 enclosure or control board); IP20 at terminals.

ADJUSTMENTS

- "Asymmetry" High voltage asymmetry tripping threshold
5...15% Ue
- "Delay" Tripping time 0.1...20s
- "Reset delay" Resetting time 0.1...20s.

Certifications and compliance

Certifications obtained: UL Listed, for USA and Canada (cULus - File E93601), as Auxiliary Devices; EAC. Compliant with standards: IEC/EN/BS 60255-27, IEC/EN/BS 61000-6-2, IEC/EN/BS 61000-6-3, UL 508, CSA C22.2 n° 14.

For three-phase systems, without neutral



PMV50...

Order code	Rated voltage to control Ue (phase-to-phase)	Qty per pkg	Wt
	[V] 50/60Hz	n°	[kg]
Three-phase system, without neutral. Minimum and maximum AC voltage. Delayed trip. Phase loss and incorrect phase sequence. Instantaneous trip.			
PMV50A240	208...240VAC	1	0.130
PMV50A575	380...575VAC	1	0.130
PMV50A600	600VAC	1	0.130

General characteristics

- Voltage monitoring relay, self powered, for minimum and maximum voltage, phase loss and incorrect phase sequence
- Configurable rated voltage (Ue):
 - PMV50A240: 208-220-230-240VAC
 - PMV50A575: 380-400-415-440-460-480-525-575VAC
- High tripping accuracy
- TRMS measurements (True Root Mean Square)
- Control of phase-to-phase voltages
- Phase loss detection if one of the voltages is <70% rated value
- Phase loss tripping time: 60ms
- 1 relay output with 1 changeover contact (SPDT)
- Modular DIN 43880 housing, 2 modules
- Mounting on 35mm DIN rail (IEC/EN/BS 60715) or screw fixing via pull out tabs
- IEC degree of protection: IP40 on front (only when placed in IP40 enclosure or control board); IP20 on terminals.

ADJUSTMENTS

- "V max" Maximum voltage tripping threshold
105...115% Ue
- "V min" Minimum voltage tripping threshold
80...95% Ue
- "Delay" for each Tripping time 0.1...20s
- "Reset delay" Resetting time 0.1...20s.

Certifications and compliance

Certifications obtained: UL Listed, for USA and Canada (cULus - File E93601) as Auxiliary Devices; EAC.
Compliant to standards: IEC/EN/BS 60255-27, IEC/EN/BS 61000-6-2, IEC/EN/BS 61000-6-3, UL 508, CSA C22.2 n° 14.



PMV70...

Order code	Rated voltage to control Ue (phase-to-phase)	Qty per pkg	Wt
	[V] 50/60Hz	n°	[kg]
Three-phase system, without neutral. Minimum and maximum AC voltage and asymmetry. Delayed trip. Phase loss and incorrect phase sequence. Instantaneous trip.			
PMV70A240	208...240VAC	1	0.130
PMV70A575	380...575VAC	1	0.130
PMV70A600	600VAC	1	0.130

General characteristics

- Voltage monitoring relay, self powered, for minimum and maximum voltage, phase loss, incorrect phase sequence and asymmetry
- Configurable rated voltage (Ue):
 - PMV70A240: 208-220-230-240VAC
 - PMV70A575: 380-400-415-440-460-480-525-575VAC
- Excellent tripping accuracy
- TRMS measurements (True Root Mean Square)
- Control of phase-to-phase voltages
- Phase loss detection if one of the voltages is <70% rated value
- Phase loss tripping time: 60ms
- 1 relay output with 1 changeover contact (SPDT)
- Modular DIN 43880 housing, 2 modules
- Mounting on 35mm DIN rail (IEC/EN/BS 60715) or screw fixing via pull out tabs
- IEC degree of protection: IP40 on front (only when placed in IP40 enclosure or control board); IP20 at terminals.

ADJUSTMENTS

- "V max" Maximum voltage tripping threshold
105...115% Ue
- "V min" Minimum voltage tripping threshold
80...95% Ue
- "Delay" for each Tripping delay 0.1...20s
- "Asymmetry" High voltage asymmetry tripping threshold
5...15% Ue.

Certifications and compliance

Certifications obtained: UL Listed, for USA and Canada (cULus - File E93601), as Auxiliary Devices; EAC.
Compliant with standards: IEC/EN/BS 60255-27, IEC/EN/BS 61000-6-2, IEC/EN/BS 61000-6-3, UL 508, CSA C22.2 n° 14.

For three-phase systems with or without neutral



PMV50N...

Order code	Rated voltage to control Ue (phase-to-phase)	Qty per pkg	Wt
	[V] 50/60Hz	n°	[kg]
PMV50NA240	208...240VAC	1	0.200
PMV50NA440	380...440VAC	1	0.200
PMV50NA600	480...600VAC	1	0.200

Three-phase system, with or without neutral.
Minimum and maximum AC voltage. Delayed trip.
Phase loss, neutral loss and incorrect phase sequence.
Instantaneous trip.

General characteristics

- Voltage monitoring relay, self powered, for minimum and maximum voltage, phase loss, neutral loss and incorrect phase sequence
- 4 configurable rated voltages (Ue):
 - **PMV50NA240**: 208-220-230-240VAC (phase-to-phase) 120-127-132-138VAC (phase-to-neutral)
 - **PMV50NA440**: 380-400-415-440VAC (phase-to-phase) 220-230-240-254VAC (phase-to-neutral)
 - **PMV50NA600**: 480-525-575-600VAC (phase-to-phase) 277-303-332-347VAC (phase-to-neutral)
- Excellent tripping accuracy
- TRMS measurements (True Root Mean Square)
- Phase loss detection when one of the voltages is <70% rated voltage
- Phase or neutral loss tripping time: 60ms
- 2 relay outputs, each with 1 changeover contact (SPDT)
- Modular DIN 43880 housing, 3 modules
- Mounting on 35mm DIN rail (IEC/EN/BS 60715) or screw fixing via pull out tabs
- IEC degree of protection: IP40 on front (only when placed in IP40 enclosure or control board); IP20 at terminals.

ADJUSTMENTS

- "V max" Maximum voltage tripping threshold 105...115% Ue
- "V min" Minimum voltage tripping threshold 80...95% Ue
- "Delay" for each Tripping time 0.1...20s
- "Reset delay" Resetting time 0.1...20s.

Certifications and compliance

Certifications obtained: EAC.
Compliant with standards: IEC/EN/BS 60255-27, IEC/EN/BS 61000-6-2, IEC/EN/BS 61000-6-3.

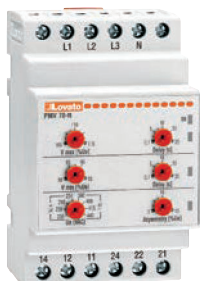

PMV70N...

Order code	Rated voltage to control Ue (phase-to-phase)	Qty per pkg	Wt
	[V] 50/60Hz	n°	[kg]
PMV70NA240	208...240VAC	1	0.200
PMV70NA440	380...440VAC	1	0.200
PMV70NA600	480...600VAC	1	0.200

Three-phase system, with or without neutral.
Minimum and maximum AC voltage and asymmetry.
Delayed trip.
Phase loss, neutral loss and incorrect phase sequence.
Instantaneous trip.

General characteristics

- Voltage monitoring relay, self powered, for minimum and maximum voltage, phase loss, neutral loss, incorrect phase sequence and asymmetry
- 4 configurable rated voltage (Ue):
 - **PMV70NA240**: 208-220-230-240VAC (phase-to-phase) 120-127-132-138VAC (phase-to-neutral)
 - **PMV70NA440**: 380-400-415-440VAC (phase-to-phase) 220-230-240-254VAC (phase-to-neutral)
 - **PMV70NA600**: 480-525-575-600VAC (phase-to-phase) 277-303-332-347VAC (phase-to-neutral)
- Excellent tripping accuracy
- TRMS measurements (True Root Mean Square)
- Phase loss detection when one of the voltages is <70% rated value
- Phase or neutral loss tripping time: 60ms
- 2 relay outputs, each with 1 changeover contact (SPDT)
- Modular DIN 43880 housing, 3 modules
- Mounting on 35mm DIN rail (IEC/EN/BS 60715) or screw fixing via pull out tabs
- IEC degree of protection: IP40 on front (only when placed in IP40 enclosure or control board); IP20 at terminals.

ADJUSTMENTS

- "V max" Maximum voltage tripping threshold 105...115% Ue
- "V min" Minimum voltage tripping threshold 80...95% Ue
- "Delay" for each Tripping time 0.1...20s
- "Asymmetry" High voltage asymmetry tripping threshold 5...15% Ue.

Certifications and compliance

Certifications obtained: EAC.
Compliant with standards: IEC/EN/BS 60255-27, IEC/EN/BS 61000-6-2, IEC/EN/BS 61000-6-3.

For three-phase systems, with or without neutral



PMV80N...

Order code	Rated voltage to control Ue (phase-to-phase)	Qty per pkg	Wt
	[V] 50/60Hz	n°	[kg]

Three-phase system, with or without neutral.
Minimum and maximum AC voltage, minimum and maximum frequency. Delayed trip.
Phase loss, neutral loss and incorrect phase sequence.
Instantaneous trip.

PMV80NA240	208...240VAC	1	0.200
PMV80NA440	380...440VAC	1	0.200
PMV80NA600	480...600VAC	1	0.200

General characteristics

- Voltage monitoring relay, self powered, for minimum and maximum voltage, minimum and maximum frequency, phase loss, neutral loss and incorrect phase sequence
- 4 configurable rated voltages (Ue):
 - PMV80NA240: 208-220-230-240VAC (phase-to-phase) 120-127-132-138VAC (phase-to-neutral)
 - PMV80NA440: 380-400-415-440VAC (phase-to-phase) 220-230-240-254VAC (phase-to-neutral)
 - PMV80NA600: 480-525-575-600VAC (phase-to-phase) 277-303-332-347VAC (phase-to-neutral)
- Excellent tripping accuracy
- TRMS measurements (True Root Mean Square)
- Phase loss detection if one of the voltages is <70% rated value
- Phase or neutral loss tripping time: 60ms
- 2 relay outputs, each with 1 changeover contact (SPDT)
- Modular DIN 43880, 3 modules
- Mounting on 35mm DIN rail (IEC/EN/BS 60715) or screw fixing via pull out tabs
- IEC degree of protection: IP40 on front (only when placed in IP40 enclosure or control board); IP20 at terminals.

ADJUSTMENTS

"V max"	Maximum voltage tripping threshold 105...115% Ue
"V min"	Minimum voltage tripping threshold 80...95% Ue
"Hz min/max"	Minimum/maximum frequency tripping threshold \pm 1...10% rated frequency
"V delay"	Tripping time 0.1...20s
"Hz delay"	Tripping time 0.1...5s.

Certifications and compliance

Certifications obtained: EAC.
Compliant with standards: IEC/EN/BS 60255-27, IEC/EN/BS 61000-6-2, IEC/EN/BS 61000-6-3.

For single-phase systems



PMV55...

Order code	Rated voltage to control Ue	Qty per pkg	Wt
	[V] 50/60Hz	n°	[kg]

Single-phase system.
Minimum and maximum AC voltage. Delayed trip.

PMV55A127	110...127VAC	1	0.125
PMV55A240	208...240VAC	1	0.125
PMV55A440	380...440VAC	1	0.125

General characteristics

- Voltage monitoring relay, self powered, for minimum and maximum voltage
- 4 configurable rated voltage (Ue):
 - PMV55A127: 110-115-120-127VAC
 - PMV55A240: 208-220-230-240VAC
 - PMV55A440: 380-400-415-440VAC
- Excellent tripping accuracy
- TRMS measurements (True Root Mean Square)
- 1 relay output with 1 changeover contact (SPDT)
- Modular DIN 43880 housing, 2 modules
- Mounting on 35mm DIN rail (IEC/EN/BS 60715) or screw fixing via pull out tabs
- IEC degree of protection: IP40 on front (only when placed in IP40 enclosure or control board); IP20 at terminals.

ADJUSTMENTS

"V max"	Maximum voltage tripping threshold 105...115% Ue
"V min"	Minimum voltage tripping threshold 80...95% Ue
"Delay" for each	Tripping time 0.1...20s
"Reset delay"	Resetting time 0.1...20s.

Certifications and compliance

Certifications obtained: UL Listed, for USA and Canada (cULus - File E93601), as Auxiliary Devices; EAC.
Compliant with standards: IEC/EN/BS 60255-27, IEC/EN/BS 61000-6-2, IEC/EN/BS 61000-6-3, UL 508, CSA C22.2 n° 14.

Multifunction voltage and frequency monitoring relays for three-phase systems with or without neutral, with NFC technology and APP



PMV95N...



The App can be downloaded from Google Play Store and App Store.



Order code	Rated voltage to control Ue (phase-to-phase)	Qty per pkg	Wt
	[V] 50/60Hz	n°	[kg]
Three-phase system, with or without neutral. Minimum and maximum AC voltage, minimum and maximum frequency and asymmetry. Delayed trip. Phase loss, neutral loss and phase sequence. Instantaneous trip. Programmable via smartphone or tablet with NFC technology and App.			
PMV95NA240NFC	208...240VAC	1	0.130
PMV95NA575NFC	380...575VAC	1	0.130

General characteristics

- Multifunction voltage and frequency monitoring relay, self powered, for minimum and maximum voltage, minimum and maximum frequency, phase loss, neutral loss, incorrect phase sequence and asymmetry.
- NFC connectivity for parameter setting with LOVATO NFC App, freely downloadable from Google Play Store and App Store
- Simple, fast and intuitive programming
- Very high accuracy and repeatability of the settings
- Possibility to save the program on smartphone or tablet to be copied on other PMV95N, even with device powered off
- Possibility to enable or disable individually the functions of interest
- Possibility to protect the settings with a password
- QR code for the direct connection to the website www.LovatoElectric.com for the download of the technical manual
- Excellent tripping accuracy
- TRMS measurements (True Root Mean Square)
- Phase loss detection if one of the voltages is <70% rated value
- 1 relay output with changeover contact (SPDT)
- Modular DIN 43880 housing, 2 modules
- Mounting on 35mm DIN rail (IEC/EN/BS 60715) or screw fixing via pull out tabs
- IEC degree of protection: IP40 on front (only when placed in IP40 enclosure or control board); IP20 at terminals.
- Adjustments: consult the technical manual on the website www.LovatoElectric.com.

8 protection functions in a single product, with possibility to enable or disable individually the functions of interest.

- maximum voltage
- minimum voltage
- maximum frequency
- minimum frequency
- asymmetry
- phase loss
- neutral loss
- incorrect phase sequence

Compact dimensions

Suitable for three-phase systems with or without neutral. It comes in a 2 DIN module housing

Excellent accuracy of settings with digital setting of time and tripping thresholds.

Repeatability of settings, with possibility to save the programming on the smartphone to be copied in fast way on other relays without risk of error.

Simple and intuitive programming thanks to the graphic interface of the LOVATO NFC App that shows on the display of the smartphone the functions and parameters without need to consult the technical manual.



Protection of settings with a password.

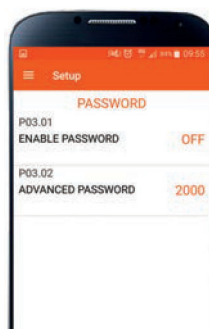

19 Monitoring relays

Frequency monitoring relays.
Current monitoring relays

Frequency monitoring relays for single and three-phase systems



PMF20...

Order code	Rated voltage Ue	Qty per pkg	Wt
	[V] 50/60Hz	n°	[kg]
Single and three-phase systems. Minimum and maximum frequency. Delayed trip. Automatic reset.			
PMF20A240	220...240VAC	1	0.125
PMF20A415	380...415VAC	1	0.125

General characteristics

- Frequency monitoring relay, self powered, for minimum and maximum control
- Rated frequency selection: 50 or 60Hz
- Tripping threshold for minimum and maximum frequency
- Excellent tripping accuracy
- 1 relay output, configurable, with 1 changeover contact (SPDT)
- Modular DIN 43880 housing, 2 modules
- Mounting on 35mm DIN rail (IEC/EN/BS 60715) or screw fixing via pull out tabs
- IEC degree of protection: IP40 on front (only when placed in IP40 enclosure or control board); IP20 at terminals.

ADJUSTMENTS

- "Hz max" Maximum frequency tripping threshold
101...110% rated frequency
- "Delay" Tripping time 0.1...20s
- "Hz min" Minimum frequency tripping threshold
90...99% rated frequency
- "Delay" Tripping time 0.1...20s
- "Reset delay" Resetting time 0.1...20s
- "Mode"
 - Minimum and maximum frequency with output relay normally energised
 - Maximum frequency with output relay normally energised
 - Minimum frequency with output relay normally energised
 - Maximum frequency with output relay normally de-energised.

Certifications and compliance

Certifications obtained: UL Listed, for USA and Canada (cULus - File E93601), as Auxiliary Devices; EAC. Compliant with standards: IEC/EN/BS 60255-27, IEC/EN/BS 61000-6-2, IEC/EN/BS 61000-6-3, UL 508, CSA C22.2 n° 14.

Current monitoring relay for single-phase systems



PMA20240

Order code	Rated current Ie	Auxiliary supply voltage	Qty per pkg	Wt
	[A]	[V]	n°	[kg]
Single-phase system. AC/DC maximum current control. Auxiliary AC/DC power supply. Automatic or manual reset.				
PMA20240	5 or 16A	24...240V AC/DC	1	0.121

General characteristics

- Current monitoring relay for AC/DC maximum current control
- AC/DC multivoltage auxiliary power supply
- Direct connection up to 16A max or by current transformer (CT)
- Excellent tripping accuracy
- TRMS current measurements (True Root Mean Square)
- Resetting and inhibition input
- 1 relay output with 1 changeover contact (SPDT)
- Modular DIN 43880 housing, 2 modules
- Mounting on 35mm DIN rail (IEC/EN/BS 60715) or screw fixing via pull out tabs
- IEC degree of protection: IP40 on front (only when placed in IP40 enclosure or control board); IP20 at terminals.

ADJUSTMENTS

- "Imax" Maximum current tripping threshold
5...100% Ie
- "Hysteresis" Maximum hysteresis threshold
1...50%
- "Trip delay" Tripping time 0.1...30s
- "Inhibition time" Inhibition delay for external input or at power up 1...60s
- "Aut. reset delay" Automatic resetting time 0.1...30s
- "Mode"
 - Rated current 5A or 16A
 - Relay output normally energised or de-energised
 - Tripping memory (latch) ON or OFF.

Certifications and compliance

Certifications obtained: UL Listed, for USA and Canada (cULus - File E93601), as Auxiliary Devices - Modular ampere monitoring relays; EAC. Compliant with standards: IEC/EN/BS 60255-27, IEC/EN/BS 61000-6-2, IEC/EN/BS 61000-6-3, UL 508, CSA C22.2 n° 14.

Current monitoring relays for single and three-phase systems



PMA30240

Order code	Rated current I _e	Auxiliary supply voltage	Qty per pkg	Wt
	[A]	[V]	n°	[kg]
Single and three-phase system. AC/DC minimum or maximum current control. Delayed trip. Auxiliary AC/DC power supply. Automatic or manual reset.				
PMA30240	5 or 16A	24...240V AC/DC	1	0.121



PMA40240

Order code	Rated current I _e	Auxiliary supply voltage	Qty per pkg	Wt
	[A]	[V]	n°	[kg]
Single and three-phase system. AC/DC minimum and maximum current control. Delayed trip. Auxiliary AC/DC power supply. Automatic or manual reset.				
PMA40240	0.02-0.05-0.25-1-5-16A	24...240V AC/DC	1	0.166

General characteristics

- Current monitoring relay for AC/DC minimum or maximum current control
- AC/DC multivoltage auxiliary power supply
- Automatic or manual reset.
- Direct connection up to 16A max or by current transformer (CT)
- Excellent tripping accuracy
- TRMS current measurements (True Root Mean Square)
- Resetting and inhibition input
- 1 relay output with 1 changeover contact (SPDT)
- Modular DIN 43880 housing, 2 modules
- Mounting on 35mm DIN rail (IEC/EN/BS 60715) or screw fixing via pull out tabs
- IEC degree of protection: IP40 on front (only when placed in IP40 enclosure or control board); IP20 at terminals.

ADJUSTMENTS

- "Set point" Minimum or maximum current tripping threshold 5...100% I_e
- "Hysteresis" Minimum or maximum hysteresis threshold 1...50%
- "Trip delay" Tripping time 0.1...30s
- "Inhibition time" Inhibition delay for external input or at power up 1...60s
- "I_e" Current scale selection: 5A or 16A
- "Mode"
 - Min or max function
 - Relay output normally energised or de-energised
 - Tripping memory (latch) ON or OFF.

Certifications and compliance

Certifications obtained: UL Listed, for USA and Canada (cULus - File E93601), as Auxiliary Devices - Modular ampere monitoring relays; EAC.
Compliant with standards: IEC/EN/BS 60255-27, IEC/EN/BS 61000-6-2, IEC/EN/BS 61000-6-3, UL 508, CSA C22.2 n° 14.

General characteristics

- Current monitoring relay for AC/DC minimum and maximum current control
- AC/DC multivoltage auxiliary power supply
- Direct connection up to 16A max or by current transformer (CT)
- Excellent tripping accuracy
- TRMS current measurements (True Root Mean Square)
- Automatic or manual resetting (manual resetting by power removal)
- 2 relay outputs (Min and Max), configurable, each with 1 changeover contact (SPDT)
- Modular DIN 43880 housing, 3 modules
- Mounting on 35mm DIN rail (IEC/EN/BS 60715) or screw fixing via pull out tabs
- IEC degree of protection: IP40 on front (only when placed in IP40 enclosure or control board); IP20 at terminals.

ADJUSTMENTS

- "I_{max}" Maximum current tripping threshold 5...100% I_e
- "I_{min}" Minimum current tripping threshold 5...100% I_e
- "Trip delay" Minimum and maximum current tripping time 0.1...30s
- "Inhibition time" Inhibition time at power up 1...60s
- "I_e" Current scale selection: 20mA, 50mA, 250mA, 1A, 5A or 16A
- "Mode"
 - Separate or common relay outputs
 - Relay output normally energised or de-energised
 - Tripping memory (latch) ON or OFF.

Certifications and compliance

Certifications obtained: UL Listed, for USA and Canada (cULus - File E93601), as Auxiliary Devices - Modular ampere monitoring relays; EAC.
Compliant with standards IEC/EN/BS 60255-27, IEC/EN/BS 61000-6-2, IEC/EN/BS 61000-6-3, UL 508, CSA C22.2 n° 14.

For single and three-phase systems



PMA50...

Order code	Rated current I_n	Auxiliary supply voltage	Qty per pkg	Wt
	[A]	[V]	n°	[kg]

Single and three-phase systems.
Maximum AC current and minimum $\cos\phi$. Delayed trip.
Phase loss and incorrect phase sequence. Instantaneous trip.
Auxiliary AC power supply.
Automatic or manual reset.

PMA50A240	5 or 16A	220...240VAC	1	0.251
PMA50A415		380...415VAC	1	0.251
PMA50A480		440...480VAC	1	0.251

General characteristics

- Pump protection relay against dry running
- Auxiliary AC power supply
- Motor under-load and over-current control
- Direct connection up to 16A max or by current transformer (CT)
- Excellent tripping accuracy
- Voltage control range 80...660VAC
- Current control range 0.1...16A
- Resetting and enabling consent input
- 1 relay output relay with 1 changeover contact (SPDT)
- Modular DIN 43880 housing, 3 modules
- Mounting on 35mm DIN rail (IEC/EN/BS 60715) or screw fixing via pull out tabs
- IEC degree of protection: IP40 on front (only when placed in IP40 enclosure or control board); IP20 at terminals.

ADJUSTMENTS

- " $\cos\phi$ min" Minimum $\cos\phi$ threshold 0.1...0.99 (under-load/dry running)
- " I_{max} " Maximum current threshold 10...100% I_n
- "Trip delay" Tripping time for minimum $\cos\phi$ and maximum current 0.1...10s
- "Inhibition time" Inhibition delay for external input or at power up 1...60s
- "Aut. reset delay" Automatic reset time OFF...100min
- "Mode"
 - Rated current 5A or 16A
 - Single or three phase
 - External reset ON or OFF.

Certifications and compliance

Certifications obtained: UL Listed, for USA and Canada (cULus - File E93601), as Auxiliary Devices - Modular ampere monitoring relays; EAC.
Compliant with standards: IEC/EN/BS 60255-27, IEC/EN/BS 61000-6-2, IEC/EN/BS 61000-6-3, UL 508, CSA C22.2 n° 14.

For low voltage



PMVF20...

Order code	Rated voltage		Qty per pkg	Wt
	Control	Auxiliary		
	[V]	[V]	n°	[kg]
PMVF20	230VAC 400VAC	100...400VAC/ 110...250VDC	1	0.568
PMVF20D048		12...48VDC	1	0.580

Low voltage system.
Dual threshold minimum and maximum voltage and frequency protection.
Flush mount type 96x96mm/3.78x3.78".

Voltage threshold per CEI 0-21

Type of protection	Tripping threshold	Tripping time
Maximum voltage 59.S2	1.15Un	0.2s
Maximum voltage 59.S1 (moving mean over 10min)	1.10Un	≤ 3s
Minimum voltage 27.S1	0.85Un	1.5s
Minimum voltage 27.S2	0.15Un	0.2s

Frequency threshold per CEI 0-21

Type of protection	Tripping threshold	Tripping time
High external signal and low local control conditions.		
Maximum frequency 81>.S2	51.5Hz	0.1s
Minimum frequency 81<.S2	47.5Hz	0.1s
Low external signal and high local control conditions.		
Maximum frequency 81>.S2	51.5Hz	1s
Minimum frequency 81<.S2	47.5Hz	4s
High conditions for both external signal and local control.		
Maximum frequency 81>.S1	50.2Hz	0.1s
Minimum frequency 81<.S1	49.8Hz	0.1s

NOTE: Low conditions for both external signal and local control are not taken into consideration by the standard.

Order code	Description
EXPANSION MODULES FOR PMVF20. For independent signal in case of phase power unbalance (LSP).	
EXP1003	2 relay outputs 5A 250VAC
Communication ports.	
EXP1010	Opto-isolated USB interface
EXP1011	Opto-isolated RS232 interface
EXP1012	Opto-isolated RS485 interface
EXP1013	Opto-isolated Ethernet interface
EXP1018 Ⓢ	IEC/EN/BS 61850 interface

Ⓢ IEC/EN/BS 61850 protocol

The EXP1018 module will be made available only when the competent authorities have established the exact terms of the supervision and control of the specific commands (currently under study as specified in the Italian CEI 0-21 standard).



EXP1003



PMVFUPS01

new

Order code	Description	Qty per pkg	Wt
Backup power supply for interface protection unit PMVF20.			
PMVFUPS01	Input 230VAC Output 230VAC with stored energy 200Ws and power 250VA	1	0.500

General characteristics

PMVF20 interface protection system (IP) unit has been developed according to the Italian CEI 0-21 standard prescriptions. It is used when a local generating system is connected in parallel with the low-voltage electric utility. The controls refer to limits of voltage and frequency monitoring.

In the case when either the voltage or the frequency are out of admissible limits, PMVF... must step in by de-energising a relay output so that the interface device (DDI) trips.

PMVF20 is equipped with 4 inputs having the following functions:

- DDI status feedback
- External signal for frequency selection (communication network malfunction)
- Local control for frequency selection
- Remote tripping (forced DDI opening independent of voltage and frequency values).

Also, there are two relay outputs for:

- DDI opening and closing
- Standby device opening (programmable: retentive normally energised, retentive normally de-energised or adjustable pulse).

The standby device control is compulsory in installations with more than 20kW and consists of a signal, with a 0.5s delay respect to the DDI opening command, transmitted only if the DDI fails and does not complete the disconnection.

By fitting the EXP10 03 expansion module on the PMVF20, the following functions can be configured as:

- Programmable alarm
- Autonomous signalling in case of phase power unbalance (LSP), only if three CTs are also installed.

Operational characteristics

- Auxiliary voltage:
 - PMVF20: 100...400VAC/110...250VDC
 - PMVF20 D048: 12...48VDC
- Voltage inputs:
 - 400VAC (three-phase connection)
 - 230VAC (single-phase connection)
- Relay outputs 5A 250VAC AC1 / 5A 30VDC
- 4 digital inputs
- Current inputs (optional): Use via CTs with selectable /5A or /1A secondary
- Parameter configuration and remote control (only with communication expansion module) with software **Synergy** and **Xpress**
- Housing: Flush mount 96x96mm/3.78x3.78"
- IEC degree of protection: IP65 on front; IP20 on terminals
- **Predisposed for IEC/EN/BS 61850 signal supervision using expansion or external module**Ⓢ.

Reference standards

Compliant with standards: Italian CEI 0-21, IEC/EN/BS 60255-27, IEC/EN/BS 61010-1, IEC/EN/BS 61000-6-2, IEC/EN/BS 61000-6-3.

Synergy: Supervision and Energy management software with remote and configuration capabilities.

Xpress: Free software for Energy management controlling one device only.

See section 30.

General characteristics for PMVFUPS01

See page 19-13.

For low voltage



PMVF51

Order code	Rated voltage		Qty per pkg	Wt
	Control	Auxiliary		
	[V]	[V]	n°	[kg]

Low voltage system.
Dual threshold minimum and maximum voltage and frequency protection.
Modular type with 2 relay outputs.

PMVF51	230VAC 400VAC	100...240VAC/ 110...250VDC	1	0.470
---------------	------------------	-------------------------------	---	-------

Voltage threshold per CEI 0-21

Type of protection	Tripping threshold	Tripping time
Maximum voltage 59.S2	1.15Un	0.2s
Maximum voltage 59.S1 (moving mean over 10min)	1.10Un	≤ 3s
Minimum voltage 27.S1	0.85Un	1.5s
Minimum voltage 27.S2	0.15Un	0.2s

Frequency threshold per CEI 0-21

Type of protection	Tripping threshold	Tripping time
High external signal and low local control conditions.		
Maximum frequency 81>.S2	51.5Hz	0.1s
Maximum frequency 81<.S2	47.5Hz	0.1s
Low external signal and high local control conditions.		
Maximum frequency 81>.S2	51.5Hz	1s
Minimum frequency 81<.S2	47.5Hz	4s

High conditions for both external signal and local control.		
Maximum frequency 81>.S1	50.2Hz	0.1s
Minimum frequency 81<.S1	49.8Hz	0.1s

NOTE: Low conditions for both external signal and local control are not taken into consideration by the standard.

Order code	Description
------------	-------------

EXPANSION MODULES FOR PMVF51.
Communication ports.

EXM1010	Opto-isolated USB interface
EXM1011	Opto-isolated RS232 interface
EXM1012	Opto-isolated RS485 interface
EXM1013	Opto-isolated Ethernet interface
EXM1018	IEC/EN/BS 61850 interface

Inputs and outputs.

EXM1001	2 digital opto-isolated inputs and 2 relay outputs 5A 250VAC
----------------	--

IEC/EN/BS 61850 protocol

The EXM1018 module will be made available only when the competent authorities have established the exact terms of the supervision and control of the specific commands (currently under study as specified in the Italian CEI 0-21 standard).



EXM10...



PMVFUPS01

new

Order code	Description	Qty per pkg	Wt
------------	-------------	-------------	----

Backup power supply for interface protection unit PMVF51.

PMVFUPS01	Input 230VAC Output 230VAC with stored energy 200Ws and power 250VA	1	0.500
------------------	--	---	-------

General characteristics

PMVF51 interface protection system (IP) unit has been developed according to the Italian CEI 0-21 standard prescriptions. Each is used when a local solar generating system is connected in parallel with the low-voltage electric utility. The controls refer to limits of voltage and frequency monitoring.

In the case when either the voltage or the frequency are out of admissible limits, PMVF51 must step in by de-energising a relay output so that the interface device (DDI) trips. PMVF51 is certified for use in single and three phase systems, where it is required in presence of storage systems connected in parallel to the distribution network and to the photovoltaic inverter on the AC side (presence of multiple energy generators simultaneously or exceeding the threshold of 11.08kW overall).

PMVF51 is equipped with 4 inputs having the following functions:

- DDI status feedback
- External signal for frequency selection (communication network malfunction)
- Local control for frequency selection
- Remote tripping (forced DDI opening, independent of voltage and frequency values).

Also, there are two relay outputs for:

- DDI opening and closing
- Standby device opening (programmable: retentive normally energised, retentive normally de-energised or adjustable pulse).

The standby device control is compulsory in installations with more than 20kW and consists of a signal, with a 0.5s delay respect to the DDI opening command, transmitted only if the DDI failed and did not complete the disconnection.

PMVF51 also has two additional relay outputs (EXM1001) to configure as:

- Programmable alarm
- Autonomous signalling in case of phase power unbalance (LSP), only if three CTs are also installed.

Operational characteristics

- Auxiliary voltage: 100...240VAC/110...250VDC
- Voltage inputs:
 - 400VAC (three-phase connection)
 - 230VAC (single-phase connection)
- Relay outputs 5A 250VAC AC1 / 5A 30VDC
- 4 digital inputs
- Current inputs (optional): Use via CTs with selectable /5A or /1A secondary
- Parameter configuration and remote control (only with communication expansion module) with software **Synergy** and **Xpress**
- Modular housing (6 modules)
- Mounting on 35mm DIN rail (IEC/EN/BS 60715) or screw fixing via pull out tabs
- Degree of protection for both: IP40 on front; IP20 on terminals
- **Predisposed for IEC/EN/BS 61850 signal supervision using expansion or external module.**

Reference standards

Compliant with standards: Italian CEI 0-21, IEC/EN/BS 60255-27, IEC/EN/BS 61010-1, IEC/EN/BS 61000-6-2, IEC/EN/BS 61000-6-3.

Synergy: Supervision and Energy management software with remote and configuration capabilities.

Xpress: Free software for Energy management controlling one device only.
See section 30.

General characteristics for PMVFUPS01

CEI 0-21 and CEI 0-16 standards require an auxiliary power supply to feed the interface protection (IP), the interface switch (IS) and the backup switch for at least 5 seconds in the event of a power failure. PMVFUPS01 guarantees the necessary energy by accumulating it in capacitors, thus avoiding the use of batteries that require maintenance.

- Power supply: 230VAC, 50Hz
- Output voltage: 230VAC, 50Hz
- Output power: 250VA
- Accumulated energy: 200Ws
- Accumulation time: 15s
- 9U modular housing
- Operating temperature: -5...+ 55°C
- Degree of protection IP20.

Reference standards

Compliant with standards: IEC/EN/BS 61010-1.

For medium voltage



PMVF30...

Voltage threshold per CEI 0-16

Order code	Rated voltage		Qty per pkg	Wt [kg]
	Control [V]	Auxiliary [V]		
PMVF30	Measurements via VTs in MV or direct in LV	100...400VAC/110...250VDC	1	0.566
PMVF30D048		12...48VDC	1	0.566

Medium-voltage system.
Dual threshold minimum and maximum voltage and frequency protection.
Flush mount type 96x96mm/3.78x3.78".

Type of protection	Tripping threshold	Tripping time
Maximum voltage 59.S2	1.2Un	0.6s
Maximum voltage 59.S1 (moving mean over 10min)	1.1Un	≤ 3s
Minimum voltage 27.S1	0.85Un	0.4s
Minimum voltage 27.S2	0.15Un	0.2s
Maximum residual voltage 59.V0 (59N)	5% Urn	25s

Frequency threshold per CEI 0-16
Frequency protection at voltage choice

Type of protection	Tripping threshold	Tripping time
Configuration in standard conditions.		
Maximum frequency 81>.S2	51.5Hz	1s
Minimum frequency 81<.S2	47.5Hz	4s
Limited configuration in case of local control or voltage choice condition.		
Maximum frequency 81>.S1	50.2Hz	0.15s
Minimum frequency 81<.S1	49.8Hz	0.15s
– Voltage choice functions		
Maximum residual voltage 59.V0 (59N)	5% Urn	-
Minimum direct sequence voltage 27.Vd	70% Un	-
Maximum inverse sequence voltage 59.Vi	15% Un	-

Order code	Description
EXPANSION MODULES FOR PMVF30. For auto reclosing management of automatic circuit breaker (DDI).	
EXP1003	2 relay outputs 5A 250VAC
Communication ports.	
EXP1010	Opto-isolated USB interface
EXP1011	Opto-isolated RS232 interface
EXP1012	Opto-isolated RS485 interface
EXP1013	Opto-isolated Ethernet interface
EXP1018Ⓢ	IEC/EN/BS 61850 interface

Ⓢ IEC/EN/BS 61850 protocol
The EXP1018 module will be made available only when the competent authorities have established the exact terms of the supervision and control of the specific commands (currently under study as specified in the Italian CEI 0-16 standard).



EXP10...



PMVFUPS01

new

Order code	Description	Qty per pkg	Wt
Backup power supply for interface protection unit PMVF30.			
PMVFUPS01	Input 230VAC Output 230VAC with stored energy 200Ws and power 250VA	1	0.500

General characteristics

PMVF30 interface protection system (IP) unit has been developed according to the Italian CEI 0-16 standard prescriptions. It is used when a local generating system is connected in parallel with the medium-voltage utility distribution grid. The controls refer to limits of voltage and frequency monitoring.

In the case when either the voltage or the frequency are out of admissible limits, PMVF... must step in by de-energising a relay output so that the interface device (DDI) trips.

PMVF30 is equipped with inputs having the following functions:

- DDI status feedback
- Interface protection system exclusion
- Local control
- Remote tripping (forced DDI opening, independent of voltage and frequency values).

In addition, there are two relay outputs to configure as:

- DDI opening
- Programmable (either as factory default for standby device opening or to set up as auto reclosing if the DDI is an automatic circuit breaker).

Standby device opening

In installations with more than 400kW, the standard specifies there must be a command signal, that releases another standby device, given within 1 second whenever the DDI opening fails or malfunctions.

Automatic DDI reclosing

Whenever an automatic circuit breaker is used as the DDI, the PMVF30 is capable of controlling both the opening (according to the installation conditions indicated in the Italian CEI 0-16 standard) and the auto reclosing. The auto reclosing function includes defining the number of attempts and the time interval between an attempt and the following one as well as generating an alarm if the closing operation does not take place.

This function can be carried out through a programmable output of the PMVF30 (unless it is already used for the standby device operation) or by installing an EXP1003 expansion module.

Operational characteristics

- Auxiliary voltage:
 - PMVF30: 100...400VAC/110...250VDC
 - PMVF30D048: 12...48VDC
- Voltage inputs (connection via VTs in MV or directly in LV end):
 - Primary: until 150,000V
 - Secondary: 50...500V (for voltage/frequency); 50...150V (for residual voltage measurement)
- Relay outputs 5A 250VAC AC1 / 5A 30VDC
- 4 digital inputs
- 3 current inputs (for optional measuring): Use via CTs with selectable /5A or /1A secondary
- Parameter configuration and remote control (only with communication expansion module) with software **Synergy** and **Xpress**
- Housing: Flush mount 96x96mm/3.78x3.78"
- Degree of protection: IP65 on front; IP20 on terminals
- **Predisposed for IEC/EN/BS 61850 signal supervision using expansion or external moduleⓈ.**

Reference standards

Compliant with standards: Italian CEI 0-16; IEC/EN/BS 60255-27, IEC/EN/BS 61010-1, IEC/EN/BS 61000-6-2, IEC/EN/BS 61000-6-3.

Synergy: Supervision and Energy management software with remote and configuration capabilities.

Xpress: Free software for Energy management controlling one device only. See section 30.

General characteristics for PMVFUPS01

See page 19-13.

19 Monitoring relays

Interface protection system units compliant with standards ENA G59-3/G99, SHAMS DUBAI - DRRG STANDARDS (DEWA), VDE-AR-N 4105, VDE V 0126-1-1, SEC (Saudi Electricity Company)



PMVF...

new

Order code	Rated voltage Control	Auxiliary	Qty per pkg	Wt
	[V]	[V]	n°	[kg]
Dual threshold minimum and maximum voltage and frequency protection, R.O.C.O.F. and Vector shift. Modular type.				
Compliant with standards DEWA DRRG and SEC (Saudi Electricity Company).				
PMVF60	Programmable	100...240VAC/ 110...250VDC	1	0.470
Compliant with standards ENA G59-3/G99.				
PMVF70	Programmable	100...240VAC/ 110...250VDC	1	0.470
Compliant with standards VDE-AR-N 4105 e VDE V 0126-1-1.				
PMVF80	Programmable	100...240VAC/ 110...250VDC	1	0.470

Voltage threshold

Protection type	PMVF60	PMVF70	PMVF80
Maximum voltage threshold 2	●	●	●
Maximum voltage threshold 1	● (10 min. average)	●	● (10 min. average)
Minimum voltage threshold 1	●	●	●
Minimum voltage threshold 2	●	●	●

Frequency threshold

Protection type	PMVF60	PMVF70	PMVF80
Maximum frequency threshold 2	Optional set to OFF	●	●
Maximum frequency threshold 1	●	●	Optional set to OFF
Minimum frequency threshold 1	●	●	Optional set to OFF
Minimum frequency threshold 2	Optional set to OFF	●	●

Order code	Description
EXPANSION MODULES FOR PMVF... Communication ports.	
EXM1010	Opto-isolated USB interface
EXM1011	Opto-isolated RS232 interface
EXM1012	Opto-isolated RS485 interface
EXM1013	Opto-isolated Ethernet interface
EXM1018	IEC/EN/BS 61850 interface
Inputs and outputs.	
EXM1001	2 digital inputs, opto-isolated and 2 relay outputs, rated 5A 250VAC



EXM10...

IEC/EN/BS 61850 protocol

The EXP1018 module will be made available only when the competent authorities have established the exact terms of the supervision and control of the specific commands (currently under study as specified in the Italian CEI 0-16 standard).

General characteristics

PMVF... interface protection system (IP) units have been developed in order to be used when a local generating system is connected in parallel with the utility distribution grid. The controls refer to limits of voltage and frequency monitoring.

In the case when either the voltage or the frequency are out of admissible limits, the PI must step in by de-energising a relay output so that the interface device (IS) trips.

PMVF... is equipped with 4 inputs having the following functions:

- IS status feedback
- R.O.C.O.F/Vector shift delay or external signal for frequency selection (communication network malfunction)
- Disabling signal
- Remote tripping (forced IS opening, independent of voltage and frequency values).

Also, there are two relay outputs for:

- IS opening and closing
- Standby device opening (programmable: retentive normally energised, retentive normally de-energised or adjustable pulse).

The backup device consists of a signal contemporary or delayed respect to the IS opening command, transmitted only if the IS failed and did not complete the disconnection. PMVF... also has two additional relay outputs (EXM1001) to configure as:

- Programmable alarm
- Autonomous signalling in case of phase power unbalance (LSP), only if three CTs are also installed.

Operational characteristics

- Auxiliary voltage: 100...240VAC/110...250VDC
- Voltage inputs:
 - 400VAC (three-phase connection)
 - 230VAC (single-phase connection)
- Relay outputs 5A 250VAC AC1 / 5A 30VDC
- 4 digital inputs
- Current inputs (optional): use via CTs with selectable /5A or /1A secondary
- Support of EXM series communications ports (USB, RS232, RS485, Ethernet) see section 31
- Parameter configuration and remote control (only with communication expansion module) with software **Synergy** and **Xpress**
- Modular housing (6 modules)
- Mounting on 35mm DIN rail (IEC/EN/BS 60715) or screw fixing via pull out tabs
- Degree of protection for both: IP40 on front; IP20 on terminals
- **Predisposed for IEC/EN/BS 61850 signal supervision using expansion or external module .**

Reference standards

Compliant with standards: DEWA DRRG (PMVF60); SEC (PMVF60); ENA G59-3/G99 (PMVF70); VDE-AR-N 4105, VDE V 0126-1-1 (PMVF80); IEC/EN/BS 60255-27; IEC/EN/BS 61010-1, IEC/EN/BS 61000-6-2, IEC/EN/BS 61000-6-4.

Synergy: Supervision and Energy management software with remote and configuration capabilities.

Xpress: Free software for Energy management controlling one device only. See section 30.

Remote control and monitoring GSM modem via SMS

Compliant with Italian CEI 0-16 Standard, paragraph 8.8.6.5 and annex M, resolution 421/2014 of the ARERA



EXCGSM01

Order code	Description
	GSM Modem (modular - 4U). IP69K outside aerial with 2.5m cable. RJ45-USB programming cable (included).
EXCGSM01	100...240VAC, 1 digital input, 1 analogic input (0...10V, 0...20mA, NTC), 1 relay output

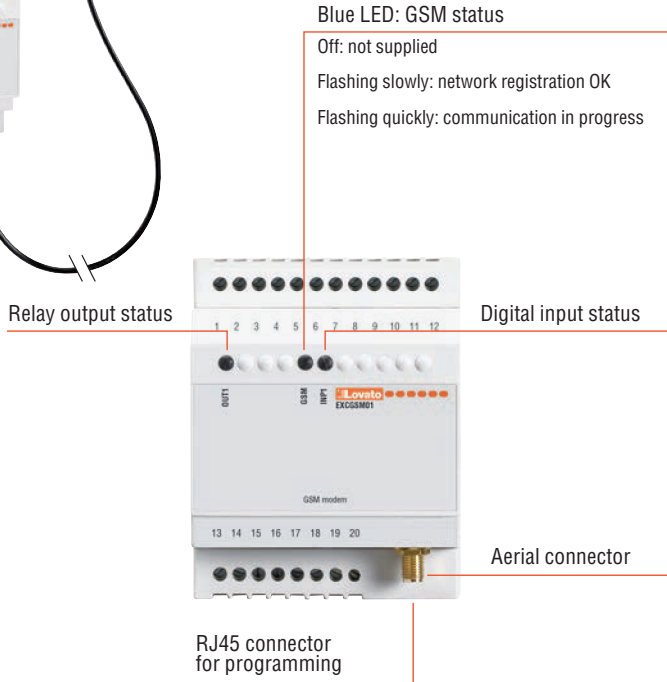

General characteristics

With EXCGSM01 it is possible to remotely operate a relay output and obtain information on the system by sending programmable SMS. Using the configuration software (downloaded for free from www.LovatoElectric.com) the user can control the relay output and both the digital and analog inputs. The logic is based on events (for example, the activation of the digital input or the arrival of an SMS with specific text), to which the user can decide specific actions (reply either by SMS or voice message, or by switching the relay output).

Use with CEI 0-16

The CEI 0-16 standard in paragraph 8.8.6.5 and in attachment M prescribes that the electricity production plants powered by wind or solar photovoltaic sources with power greater than or equal to 100kW, connected or to be connected to medium voltage grids, are equipped with GSM modem. Thanks to this modem it is possible to manage the disconnection of the generation through the messages sent by the energy distributor.

Functional characteristics

- Connection to the GSM network for sending and receiving SMS messages
 - Programmable message texts
 - Command output piloted by SMS or internal logic, for example to send the remote disconnection command to the interface device CEI 0-16
 - Programmable digital input, for example to detect the status of the Interface Switch (IS) and sending of successful IS opening and closing SMSs
 - POD management (active user code)
 - Management of the list of caller IDs (CLI) up to 5000 callers enabled
 - Detection of mobile network coverage
 - Full compatibility with medium-voltage PI LOVATO Electric PMVF30: no software/hardware updates or programming required
 - **Compatibility with third-party PIs where the remote disconnection signal is transmitted via digital input (dry contact)**
- For additional information contact our Technical support
Tel. + 39 035 4282422; E-mail: service@LovatoElectric.com.

Software

To configure the EXCGSM01 modem (using the RJ45-USB programming cable included), the EXCGSMSW software must be used. This can be downloaded for free from the www.LovatoElectric.com website. The software allows you to set:

- the users enabled to exchange messages with the modem
 - the identifier of the modem, for example the active customer code (POD) in CEI 0-16 applications;
 - the functions assigned to the digital output and input and to analog input;
 - the texts of the SMS associated with the commands
 - the logic of the actions taken following the SMS arrival, change of input status, alarm situations.
- Configuration is also possible off-line, creating a file to transfer to the modem at another time.

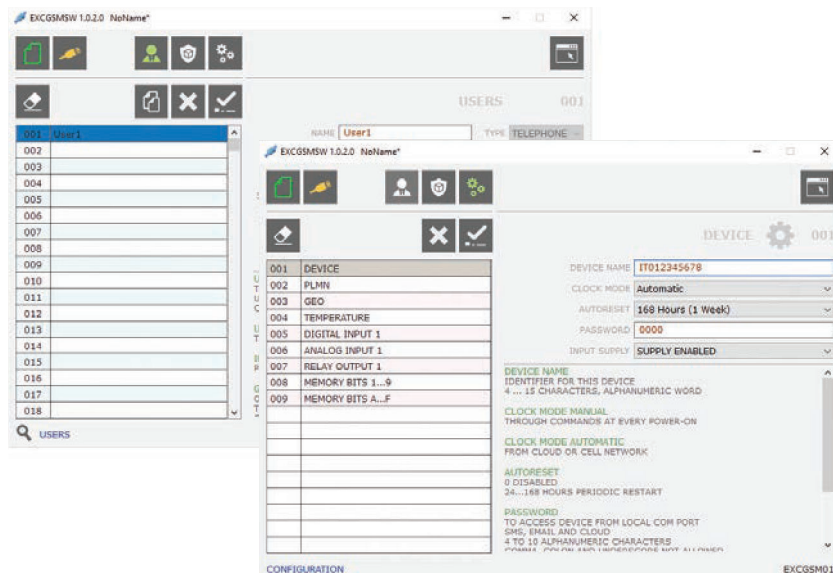

Operational characteristics

- MODEM**
- 35mm DIN (IEC/EN/BS 60715) rail fixing
 - 4 modules
 - Supply: 100...240VAC
 - Consumption: 5VAC
 - 1 digital output 3A 250VAC
 - 1 self-supplied digital input
 - 1 analog input 0...10V, 0...20mA, NTC
 - Housing for 3V and 1.8V SIM card
 - SIM PIN management
 - Temperature sensor
 - Update time, sunrise and sunset via GSM network
 - Position update via GSM
 - Certified according to FCC rules, part 15B
 - Operating temperature: -20...+60°C
 - Protection rating: IP40 on front; IP20 on terminals.

AERIAL

- Quad band 850/900/1800/1900MHz
- Degree of protection: outside IP69K
- 2.5m cable
- Fixing via M10 hole:
 - with adhesive seal
 - with threaded pin and nut.

Compliance

Compliant with electrical safety standards: EN/BS 62368, EN/BS 62311.

PMVF20...

Three-phase connection

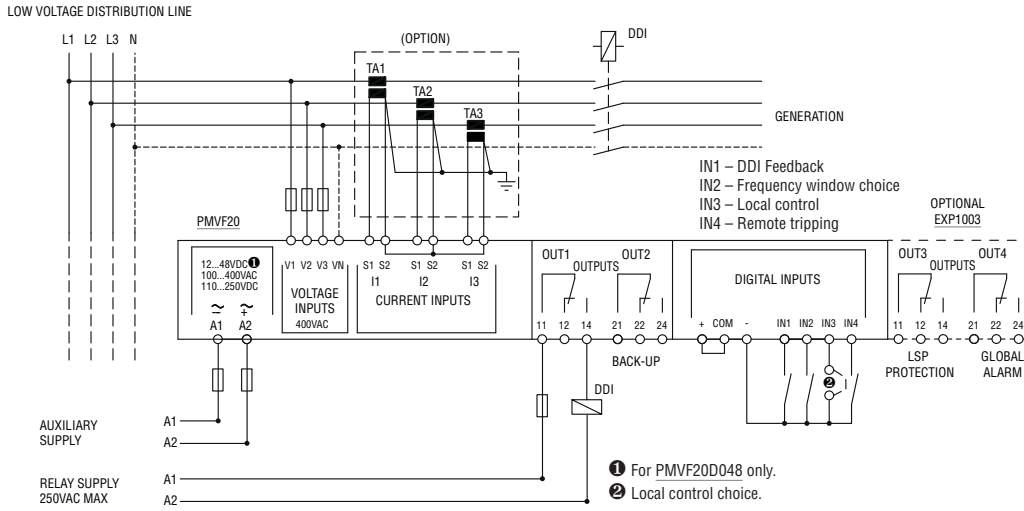

Rear view

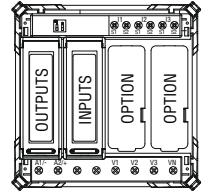

PMVF51

Three-phase connection

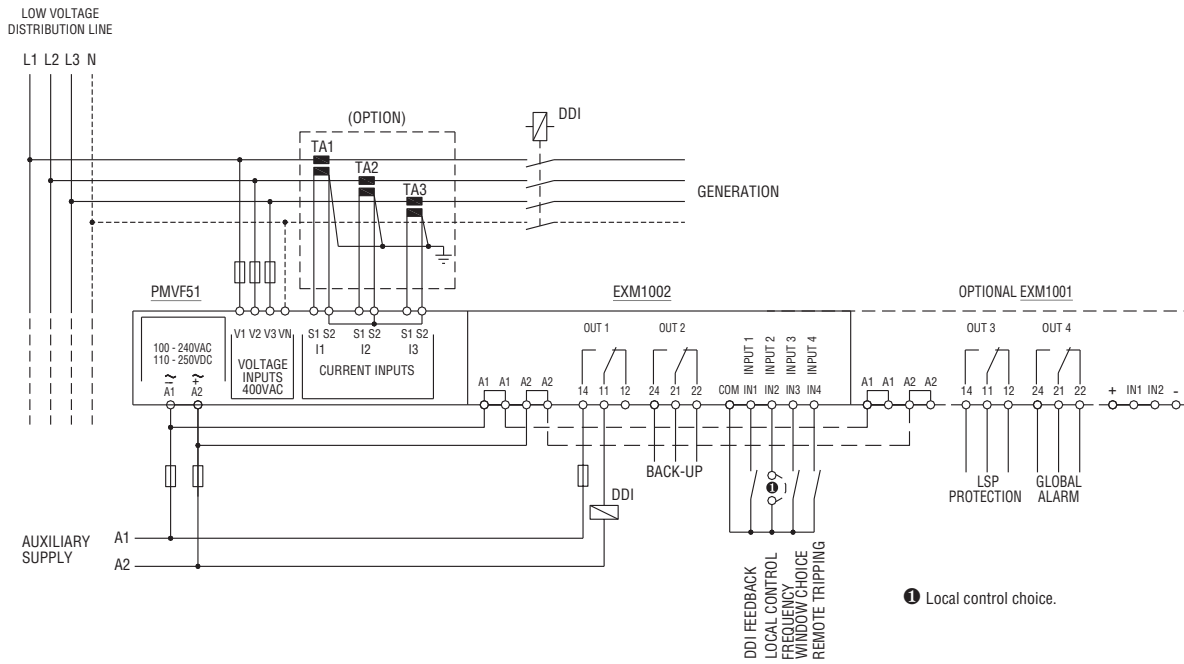

PMVF60

Three-phase connection

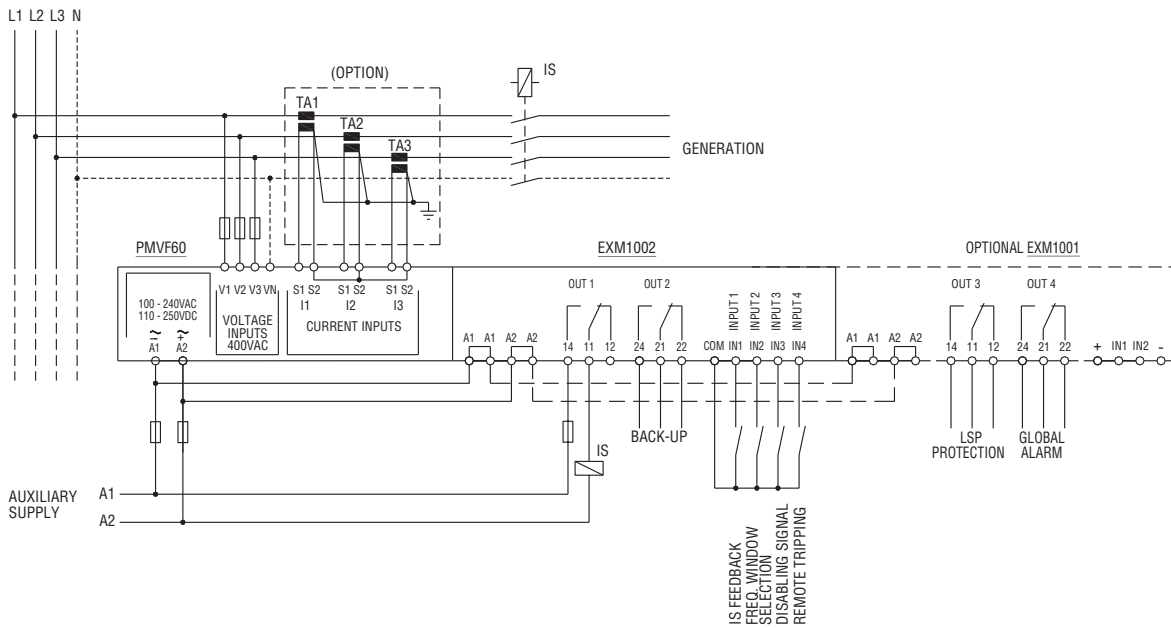

PMVF70 - PMVF80

Three-phase connection

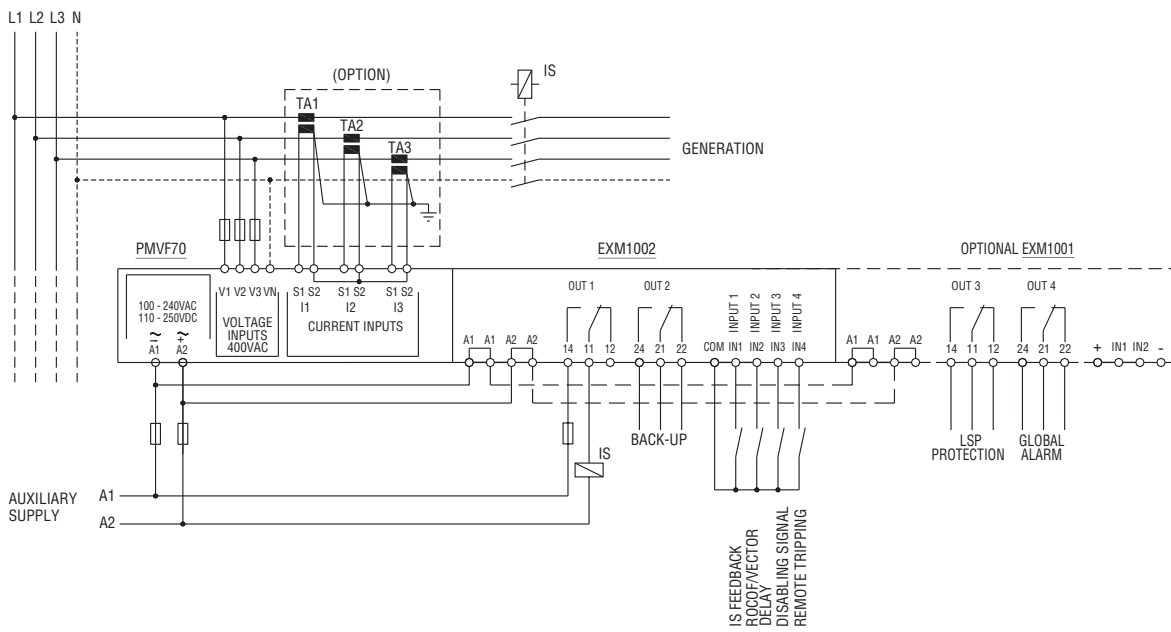

PMVF30...

Connection through VTs in Medium Voltage
Three-phase connection

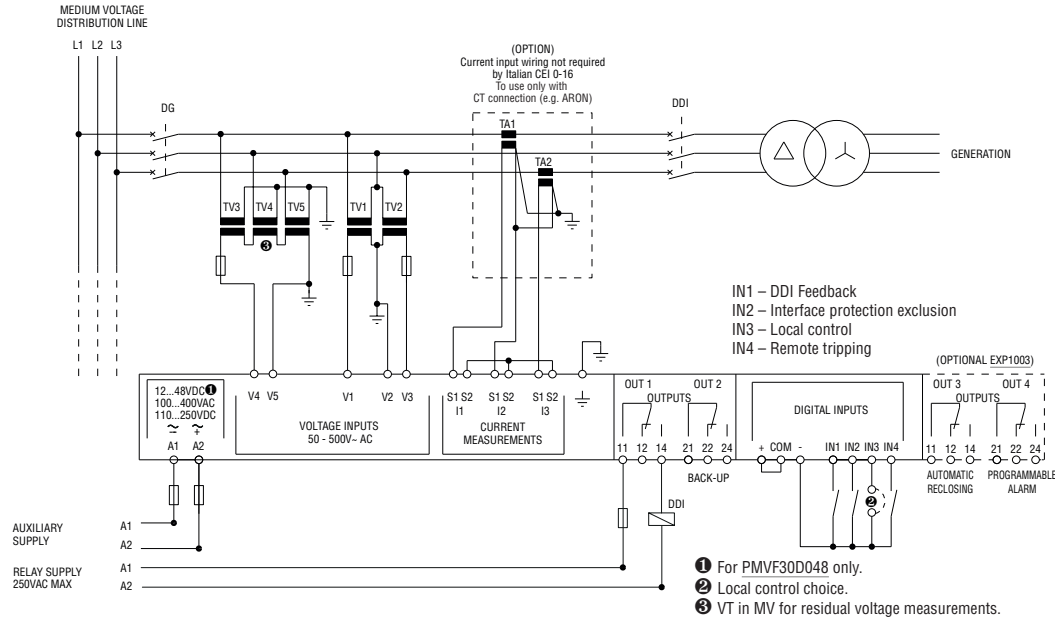

Rear view

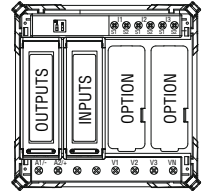

Direct connection in Low Voltage Three-phase connection

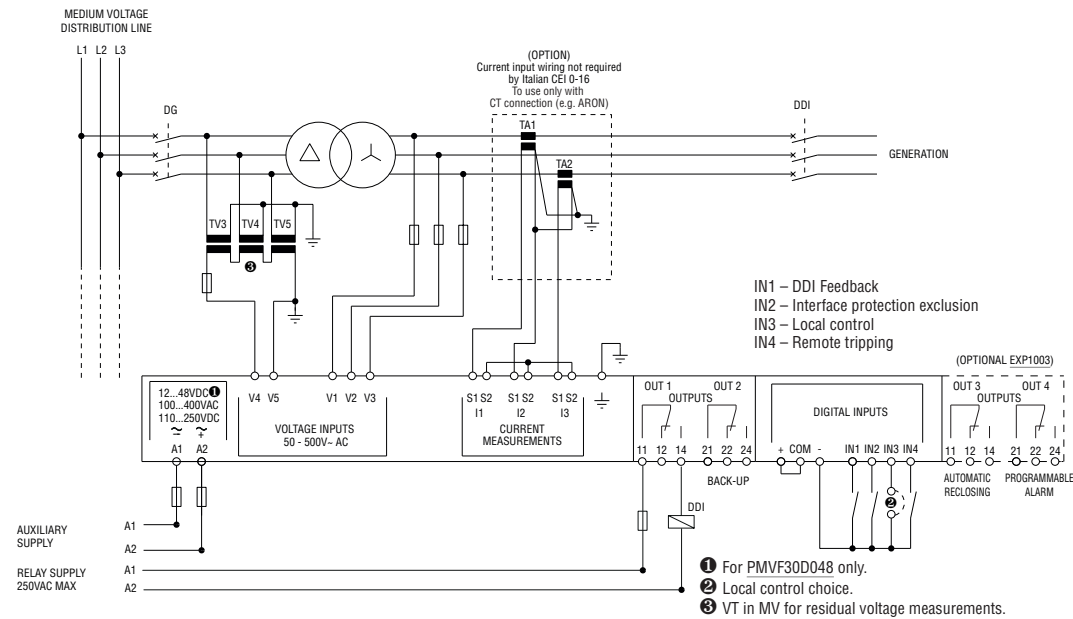

Rear view

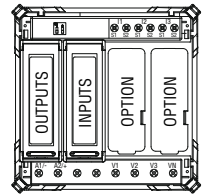

PMVFUPS01

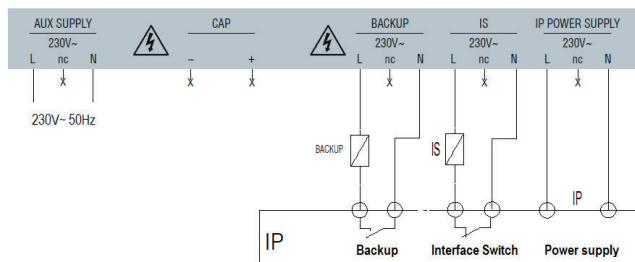

PMVF30... with EXCGSM01

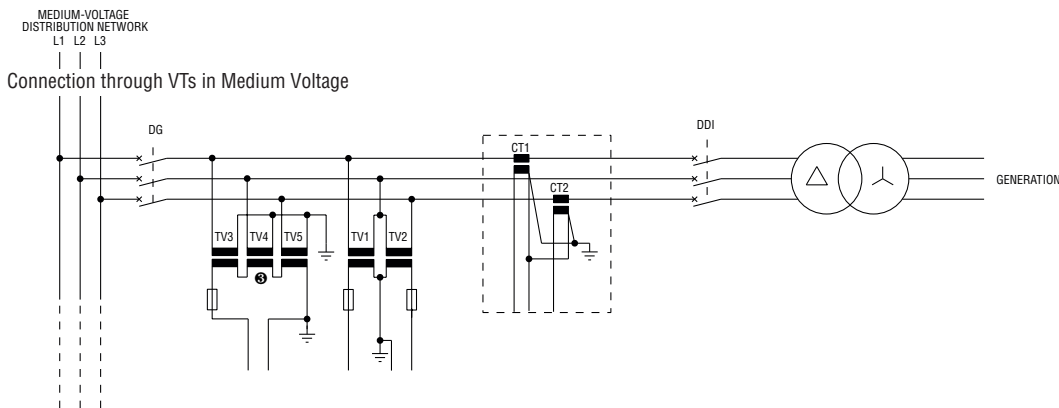

Direct connection in Low Voltage - Three-phase connection

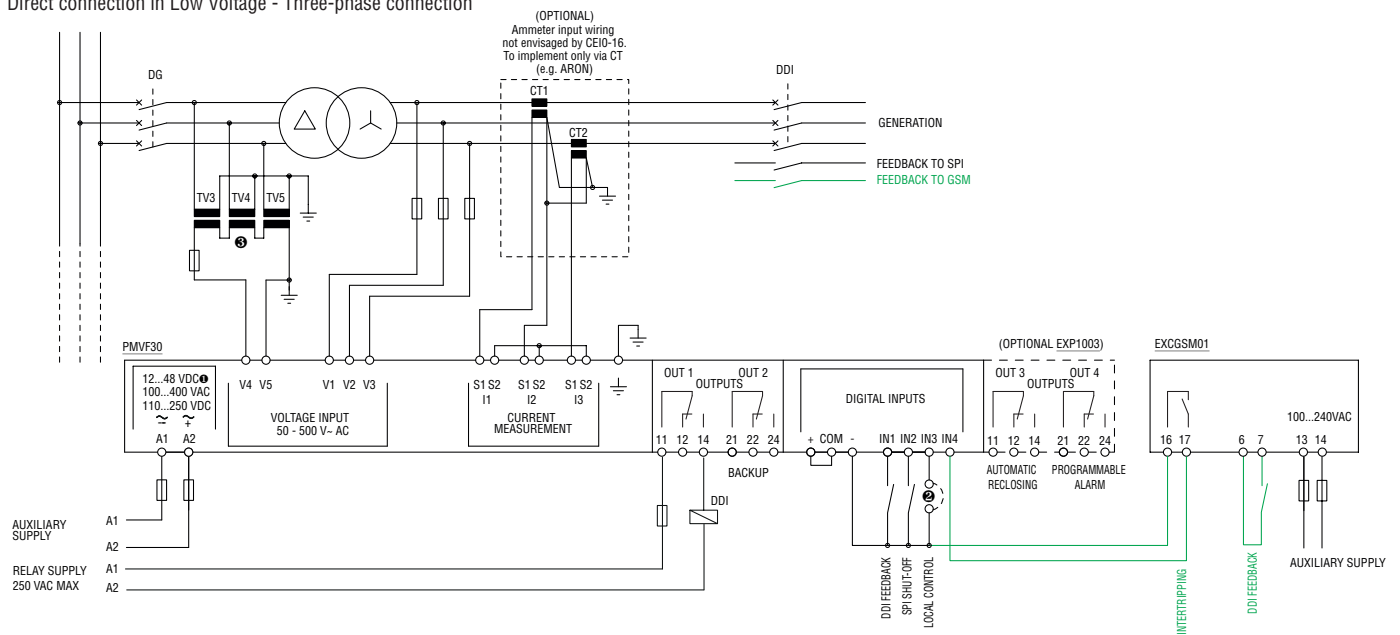

- ❶ For PMVF30D048 only.
- ❷ Local control choice.
- ❸ VT in MV for residual voltage measurements.

The connections coloured in GREEN, in addition to the GSM Modem, represent the only wiring necessary for the adaptation.

EXCGSM01 modem wiring diagram with other interface protections (PI) with self-supplied remote disconnection input

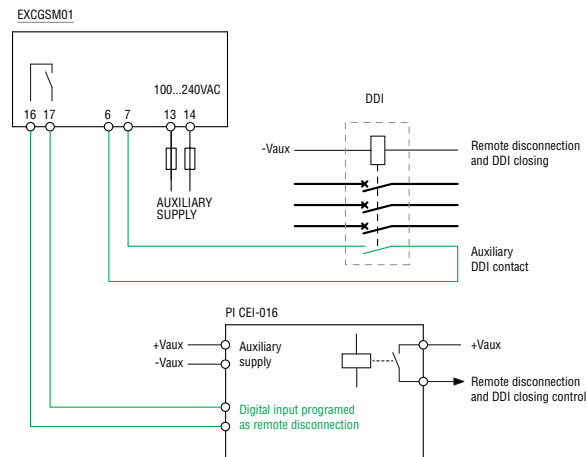

The connections coloured in GREEN, in addition to the GSM Modem, represent the only wiring necessary for the adaptation.

EXCGSM01 modem wiring diagram with other interface protections (PI) with remote disconnection input to be supplied

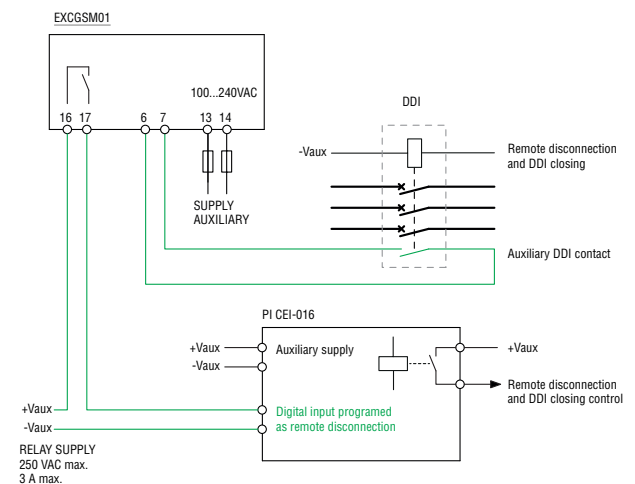

19 Monitoring relays

Technical characteristics Voltage monitoring relays



INDEX

TYPE	Single phase	PMV55	—	—	—	—
	Three phase	—	PMV10	PMV20	PMV30	PMV40
	Three phase with/without neutral	—	—	—	—	—
DESCRIPTION						
	Minimum and maximum AC voltage		Phase loss and incorrect phase sequence		Minimum AC voltage, phase loss and incorrect phase sequence	Asymmetry, phase loss and incorrect phase sequence
CONTROL CIRCUIT						
Rated voltage to control (Ue)	110...127VAC	208...480VAC	100...240VAC	208...240VAC		
	208...240VAC		208...575VAC	380...575VAC		
	380...440VAC		380...600VAC	600VAC		
Maximum voltage set-point	105...115% Ue	—	—	—	—	
Minimum voltage set-point	80...95% Ue	—	—	80...95% Ue	—	
Asymmetry set-point	—	—	—	—	5...15%Ue	
Minimum and maximum frequency set-point	—	—	—	—	—	
Tripping time	0.1...20s		60ms		0.1...20s	
Resetting time	0.1...20s (0.5s at power up)		0.5s		0.1...20s (0.5s at power up)	
Resetting hysteresis	3%		5%		3%	
Instantaneous tripping for Ue	<70% Ue configured		Umin<70% Ue		<70% Ue configured	<70% Ue configured
Repeat accuracy	< ±0.1%		< ±1%		< ±0.1%	< ±0.1%
POWER SUPPLY						
Auxiliary voltage (Us)	Self powered					
Operating range	0.7...1.2Ue		0.85...1.1Ue		0.7...1.2Ue	
Frequency	50/60Hz ±5%					
Power consumption (maximum)	10VA (208...240VAC)ⓘ 17VA (380...440VAC)ⓘ	20VAⓘ	28VAⓘ		11VA (208...240VAC)ⓘ 30VA (380...575VAC)ⓘ 19VA (600VAC)ⓘ	
Power dissipation (maximum)	1.5W	2.2W			2.5W	
RELAY OUTPUTS						
Number of relays	1					
Relay state	Normally energised De-energises at tripping					
Contact arrangement	1 changeover SPDT					
Rated operational voltage	250VAC					
Maximum switching voltage	400VAC					
Conventional free-air thermal current (Ith)	8A					
UL/CSA and IEC/EN/BS 60947-5-1 designation	B300					
Electrical life (with rated load)	10 ⁵ cycles					
Mechanical life	30x10 ⁶ cycles					
Indications	1 green LED for power on and tripping 2 red LEDs for tripping		1 green LED for power on and tripping		1 green LED for power on and tripping 1 red LED for tripping	
CONNECTIONS						
Terminal tightening torque (maximum)	0.8Nm (7lb.in; 7...9lb.in for UL/CSA)					
Conductor section min...max	0.2...4.0mm ² (24...12AWG; 18...12AWG for UL/CSA)					
INSULATION (input-output)						
IEC rated insulation voltage Ui	440VAC	480VAC			600VAC	
IEC rated impulse withstand voltage Uimp	6kV					
IEC power frequency withstand voltage	4kV					
AMBIENT CONDITIONS						
Operating temperature	-20...+60°C					
Storage temperature	-30...+80°C					
HOUSING						
Material	Self-extinguishing polyamide					

ⓘ Power consumption (maximum) at 50Hz.

19 Monitoring relays

Technical characteristics
Voltage monitoring relays

	—	—	—	—	—	—
	PMV50	PMV70	—	—	—	—
	—	—	PMV50N	PMV70N	PMV80N	PMV95N
	Minimum and maximum AC voltage, phase loss and incorrect phase sequence	Minimum and maximum AC voltage, phase loss, incorrect phase sequence and asymmetry	Minimum and maximum AC voltage, phase loss, neutral loss and incorrect phase sequence	Minimum and maximum AC voltage, phase loss, neutral loss, incorrect phase sequence and asymmetry	Minimum and maximum AC voltage and frequency, phase loss, neutral loss and incorrect phase sequence	Minimum and maximum AC voltage and frequency, phase loss, neutral loss, incorrect phase sequence and asymmetry
	208...240VAC	208...240VAC	208...240VAC	208...240VAC	208...240VAC	208...240VAC
	380...575VAC	380...440VAC	380...440VAC	380...440VAC	380...440VAC	380...575VAC
	600VAC	600VAC	480...600VAC	480...600VAC	480...600VAC	—
	105...15% Ue	105...115% Ue	105...115% Ue	105...115% Ue	105...115% Ue	105...115% Ue
	80...95% Ue	80...95% Ue	80...95% Ue	80...95% Ue	80...95% Ue	80...95% Ue
	—	5...15% Ue	—	5...15% Ue	—	5...15% Ue
	—	—	—	—	±1...10% rated frequency	±1...10% rated frequency
	0.1...20s				0.1...20s	0.1...5s freq.
	0.1...20s (0.5s at power up)	0.5s	0.1...20s (0.5s at power up)	0.5s	0.5s	0.1...30s (0.5s at power up)
	3%	3%	3%	3%	3% 0.5% freq.	1...5%
	<70% Ue configured < ±0.1%					
	Self powered					
	0.7...1.2Ue					
	50/60Hz ±5%	50/60Hz ±10%				
	11VA (208...240VAC)ⓘ 30VA (380...575VAC)ⓘ 19VA (600VAC)ⓘ	27VA			30VA	
	2.5W	1.9W			2.5W	
	1	2			1	
	Normally energised De-energises at tripping					
	1 changeover SPDT	2 changeover SPDT			1 changeover SPDT	
	250VAC					
	400VAC					
	8A					
	B300					
	10 ⁵ cycles					
	30x10 ⁶ cycles					
	1 green LED for power on and tripping 2 red LEDs for tripping	1 green LED for power on and tripping 3 red LEDs for tripping	1 green LED for power on and tripping 2 red LEDs for tripping	1 green LED for power on and tripping 3 red LEDs for tripping		1 green LED for power 5 red LEDs for tripping
	0.8Nm (7lb.in; 7...9lb.in for UL/CSA - PMV50N/70N/80N excluded)					
	0.2...4.0mm ² (24...12AWG; 18...12AWG for UL/CSA - PMV50N/70N/80N excluded)					
	600VAC					
	6kV					
	4kV					
	-20...+60°C					
	-30...+80°C					
	Self-extinguishing polyamide					

19 Monitoring relays

Technical characteristics
Current monitoring relays

TYPE	PMA20	PMA30	PMA40
DESCRIPTION	Single-phase maximum current monitoring AC/DC multiscale	Single-phase minimum or maximum current monitoring AC/DC multiscale	Single-phase minimum and maximum current monitoring AC/DC multiscale
CONTROL CIRCUIT			
Rated current	5 or 16A		0.02 - 0.05 - 0.25 - 1 - 5 - 16A
Rated frequency	50/60Hz ±5%		
Overload capacity	5 le for 1s 160A for 10ms Constant 16A	50mA - 1A inputs: 5 le for 1s 10le for 10ms Constant 2le	16A input: 5 le for 1s 160A for 10ms Constant 16A
Connection	Direct or by current transformer		
Adjustment	Tripping values 5...100% f.s.		
	Tripping time 0.1...30s		
	Inhibition time 1...60s		
	1...50%	3% fixed	
Resetting	Automatic or manual		
External input	Resetting or inhibition		—
Repeat accuracy	±1% with constant parameters		
AUXILIARY SUPPLY			
Auxiliary supply voltage Us	24...240VAC/DC		
Operating range	0.85...1.1Us		
Rated frequency	50/60Hz ±5%		
Power consumption (maximum)	3.2VA	7VA	
Power dissipation (maximum)	1.6W	1.7W	
RELAY OUTPUTS			
Number of relays	1		2
Relay state	Normally energised / de-energised (selectable)		
Contacts arrangement	1 changeover contact SPDT each		
Rated operational voltage	250VAC		
Maximum switching voltage	400VAC		
IEC conventional free air thermal current Ith	8A		
UL/CSA and IEC/EN/BS 60947-5-1 designation	B300		
Electrical life (with rated load)	10 ⁵ cycles		
Mechanical life	30x10 ⁶ cycles		
Indications	1 green LED for power on/inhibition 1 red LED for tripping	1 green LED for power on/inhibition 2 red LEDs for max/min tripping	
CONNECTIONS			
Tightening torque maximum	0.8Nm (7lb.in; 7...9lb.in per UL/CSA)		
Conductor section min...max	0.2...4.0mm ² (24...12AWG; 18...12AWG per UL/CSA)		
INSULATION (input-output)			
IEC rated insulation voltage Ui	415VAC		
IEC rated impulse withstand voltage Uimp	4kV		
IEC power frequency withstand voltage	2.5kV		
AMBIENT CONDITIONS			
Operating temperature	-20...+60°C		
Storage temperature	-30...+80°C		
HOUSING			
Material	Self-extinguishing polyamide		

19 Monitoring relays

Technical characteristics
Pump protection

TYPE	PMA50	
DESCRIPTION	Single and three-phase pump protection (motor under-load and over-current control) monitoring for max AC current, min $\cos\varphi$, phase loss and incorrect phase sequence	
CURRENT AND $\cos\varphi$ CONTROL CIRCUIT		
Rated current I_e	5 or 16A	
Rated frequency	50/60Hz $\pm 5\%$	
Overload capacity	5 I_e for 1s 160A for 10ms Constant 16A	
Connection	Direct or by current transformer	
Adjustments	End-scale value	5 or 16A
	Tripping for MAX current	10...100 I_e
	Tripping for $\cos\varphi$	0.1...0.99 $\cos\varphi$ (Min)
	Tripping delay	0.1...10s
	Inhibition time	1...60s
	Automatic resetting delay	OFF...100min
External input	Consent for running/resetting	
Repeat accuracy	$\pm 1\%$ with constant parameters	
VOLTAGE CONTROL CIRCUIT		
Voltage measuring range (U_e)	80...660VAC	
Tripping time for phase loss	60ms	
AUXILIARY SUPPLY		
Auxiliary supply voltage U_s	220...240VAC	
	380...415VAC (maximum voltage for UL/CSA)	
	440...480VAC	
Operating range	0.85...1.1 U_s	
Frequency range	50/60Hz $\pm 5\%$	
Power consumption (maximum)	4.5VA	
Power dissipation (maximum)	2.3W	
RELAY OUTPUTS		
Number of relays	1	
Relay state	Normally energised, de-energises at tripping	
Contact arrangement	1 changeover contact SPDT	
Rated operational voltage	250VAC	
Maximum switching voltage	400VAC	
IEC conventional free air thermal current I_{th}	8A	
UL/CSA and IEC/EN/BS 60947-5-1 designation	B300	
Electrical life (With rated load)	10 ⁵ cycles	
Mechanical life	30x10 ⁶ cycles	
Indications	1 green LED for power on/inhibition 2 red LEDs for tripping	
CONNECTIONS		
Tightening torque maximum	0.8Nm (7lb.in)	
Conductor section min...max	0.2...4.0mm ² (24...12AWG; 18...12AWG per UL/CSA)	
INSULATION (input-output)		
IEC rated insulation voltage U_i	600VAC	
IEC rated impulse withstand voltage U_{imp}	6kV	
IEC power frequency withstand voltage	2.5kV	
AMBIENT CONDITIONS		
Operating temperature	-20...+60°C	
Storage temperature	-30...+80°C	
HOUSING		
Material	Self-extinguishing polyamide	

19 Monitoring relays

Technical characteristics
Frequency monitoring relays

TYPE		PMF20
DESCRIPTION		Single-phase minimum and maximum frequency control
FREQUENCY CONTROL CIRCUIT		
Rated frequency		50 or 60Hz selectable
Operating frequency range		40...70Hz
Adjustment	MAX tripping	101...110% operating frequency
	MIN tripping	90...99% operating frequency
	Resetting hysteresis	0.5%
	Inhibition time	0.1...20s
	Reset delay	0.1...20s
Resetting		Automatic
Repeat accuracy		< ±0.1%
AUXILIARY POWER SUPPLY		
Rated supply voltage U _e		220...240VAC 380...415VAC
Operating range		0.85...1.1U _e
Rated frequency		50/60Hz
Power consumption (maximum)		10VA (220...240VAC); 17VA (380...415VAC)
Power dissipation (maximum)		1.5W
RELAY OUTPUTS		
Number of relays		1
Relay state		Normally energised, de-energises at tripping ^❶
Contact arrangement		1 changeover contact SPDT
Rated operational voltage		250VAC
Maximum switching voltage		400VAC
IEC conventional free air thermal current I _{th}		8A
UL/CSA and IEC/EN/BS 60947-5-1 designation		B300
Electrical life (with rated load)		10 ⁹ cycles
Mechanical life		30x10 ⁶ cycles
Indications		1 green LED for power on/tripping 2 red LEDs for min-max tripping
CONNECTIONS		
Tightening torque maximum		0.8Nm (7lb.in)
Conductor section min-max		0.2...4.0mm ² (24...12AWG)
INSULATION (input - output)		
IEC rated insulation voltage U _i		575VAC
IEC rated impulse withstand voltage U _{imp}		6kV
IEC power frequency withstand voltage		4kV
AMBIENT CONDITIONS		
Operating temperature		-20...+60°C
Storage temperature		-30...+80°C
HOUSING		
Material		Self-extinguishing polyamide

❶ Normally de-energised, energises at tripping with MAX function configured.

19 Monitoring relays

Technical characteristics
Interface protection system units

TYPE	PMVF20	PMVF20D048
AUXILIARY POWER SUPPLY		
Rated control supply voltage U_s	100...400VAC/110...250VDC	12...48VDC
Operating limits	90...440VAC/93.5...300VDC	9...70VDC
Frequency	45...55Hz	—
Power consumption max	3.9VA	2.5W
Power dissipation max	3.4W	2.5W
Micro-breaking immunity	≤ 50 ms at 110VAC ; ≤ 200 ms at 230VAC	≤ 15 ms at 12VDC; ≤ 30 ms at 24VDC; ≤ 70 ms at 48VDC
Overload category	III	III
VOLTAGE INPUTS		
Maximum rated operating voltage	400VAC L-L; 230VAC L-N 50Hz	
Measuring range	20...480VAC L-L; 10...276VAC L-N	
Frequency range	45...55Hz	
Overload category	IV	
CURRENT INPUTS (OPTIONAL)		
Rated operational current I_e	1A or 5A in AC programmable	
Measuring range	For 1A scale: 0.01...1.2A; for 5A scale: 0.01...6A	
Type of input	Shunts powered by external current transformer (low voltage) 5A max.	
Type of measurement	RMS	
Overload capacity	$\pm 20\%$ I_e	
Overload peak	50A for 1 second	
Burden (per phase)	≤ 0.6 W	
RELAY OUTPUTS		
Number of outputs	2	
Type of output	1 changeover contact/SPDT each	
Rated operating voltage	250VAC	
UL/CSA and IEC/EN/BS 60947-5-1 designation	5A 250VAC AC1 /B300 ; 5A 30VDC	
Overload category	III	
DIGITAL INPUTS		
Number and type of inputs	4 negative (NPN)	
Input voltage	24VDC isolated	
Input current	7mA	
SUPPLY/VOLTAGE MEASURING CIRCUIT CONNECTIONS		
Type of terminals	Screw - removable	
Conductor section (min...max)	0.2...2.5mm ² (24...12AWG)	
Tightening torque	0.5Nm (4.5lb.in)	
CURRENT MEASURING CIRCUIT CONNECTIONS		
Type of terminals	Screw - fixed	
Number of terminals	6 for external CT connections	
Conductor section (min...max)	0.2...4mm ² (26...10AWG)	
Tightening torque	0.8Nm (7lb.in)	
RELAY OUTPUT CONNECTIONS		
Type of terminals	Screw - removable	
Conductor section (min...max)	0.2...2.5 mm ² (24...12AWG)	
Tightening torque	0.5Nm (4.5lb.in)	
INPUT CONNECTIONS – Input terminals		
Type of terminals	Screw - removable	
Conductor section (min...max)	0.2...1.5 mm ² (28...14AWG)	
Tightening torque	0.18Nm (1.7lb.in)	
INPUT CONNECTIONS – COM and auxiliary voltage terminals		
Type of terminals	Screw - removable	
Conductor section (min...max)	0.2...2.5 mm ² (24...12AWG)	
Tightening torque	0.5Nm (4.5lb.in)	
HOUSING		
Material	Polyamide	
Version	Flush mount 96x96mm / 3.78x3.78"	

19 Monitoring relays

Technical characteristics
Interface protection system units

TYPE	PMVF51 - PMVF60 - PMVF70 - PMVF80
AUXILIARY POWER SUPPLY	
Rated control supply voltage U_s	100...240VAC/110...250VDC
Operating limits	85...264VAC/93.5...300VDC
Frequency	45...55Hz
Power consumption	AC supply 4.6VA at 110VAC; 12.5VA at 230VAC DC supply 23mA at 110VDC; 11mA 250VDC
Power dissipation	AC supply 2.5W at 110VAC; 2.7W at 230VAC DC supply 2.3W at 110VDC; 2.5W at 250VDC
Micro-breaking immunity	≤ 50 ms at 100VDC; ≤ 200 ms at 240VDC
Overload category	II
VOLTAGE INPUTS	
Maximum rated operating voltage	400VAC L-L; 230VAC L-N 50Hz
Measuring range	20...480VAC L-L; 10...276VAC L-N
Frequency range	45...55Hz
Overload category	IV
CURRENT INPUTS (OPTIONAL)	
Rated operational current I_e	1A or 5A in AC programmable
Measuring range	For 1A scale: 0.01...1.2A; for 5A scale: 0.01...6A
Type of measurement	RMS
Overload capacity	$\pm 20\%$ I_e
Overload peak	50A for 1 second
Burden (per phase)	≤ 0.6 W
RELAY OUTPUTS	
Number of outputs	2 ^①
Type of output	1 changeover contact/SPDT each
Rated operating voltage	250VAC
UL/CSA and IEC/EN/BS 60947-5-1 designation	For NO contact: 5A 250VAC AC1/C300; 5A 30VDC For NC contact: 2A 250VAC AC1 / C300; 2A 30VDC
Overload category	II
DIGITAL INPUTS	
Number and type of inputs	4 positive (PNP)
Input voltage	24VDC isolated
Input current	7mA
SUPPLY/VOLTAGE MEASURING CIRCUIT CONNECTIONS	
Type of terminals	Screw - removable
Conductor section (min...max)	0.2...4mm ² (24...12AWG)
Tightening torque	0.8Nm (4.5lb.in)
CURRENT MEASURING CIRCUIT CONNECTIONS	
Type of terminals	Screw - fixed
Number of terminals	6 for external CT connections
Conductor section (min...max)	0.2...2.5mm ² (24...12AWG)
Tightening torque	0.44Nm (4lb.in)
RELAY OUTPUT CONNECTIONS	
Type of terminals	Screw - removable
Conductor section (min...max)	0.2...2.5 mm ² (24...12AWG)
Tightening torque	0.44Nm (4lb.in)
INPUT CONNECTIONS – Input terminals	
Type of terminals	Screw - removable
Conductor section (min...max)	0.2...2.5 mm ² (24...12AWG)
Tightening torque	0.5Nm (4.5lb.in)
HOUSING	
Material	Polyamide
Version	Modular 6U

① Single insulation between the two outputs. Both outputs must use the same voltage group.

19 Monitoring relays

Technical characteristics
Interface protection system units

TYPE	PMVF30	PMVF30D048
AUXILIARY POWER SUPPLY		
Rated control supply voltage U_s	100...400VAC / 110...250VDC	
Operating limits	90...440VAC / 93,5...300VDC	
Frequency	45...55Hz	
Power consumption max	3.9VA	2.9W
Power dissipation max	3.4W	2.9W
Micro-breaking immunity	$\leq 30\text{ms}$ a 110VAC; $\leq 140\text{ms}$ a 230VAC	
Overload category	III	
VOLTAGE INPUTS		
Maximum rated operating voltage	50...500VAC (for voltages/frequency) / 50...150V (for residual voltage measurement)	
Measuring range (U_n)	400-150,000V (VT primary)	
Frequency range	45...55Hz	
Overload category	IV	
CURRENT INPUTS (OPTIONAL)		
Rated operational current I_e	1A or 5A in AC programmable	
Measuring range	For 1A scale: 0.01...1.2A; for 5A scale: 0.01...6A	
Type of input	Shunts powered by external current transformer (low voltage) 5A max.	
Type of measurement	RMS	
Overload capacity	$\pm 100\%$ I_e	
Overload peak	50A for 1 second	
Burden (per phase)	$\leq 0.3\text{W}$	
RELAY OUTPUTS		
Number of outputs	2	
Type of output	1 changeover contact/SPDT each	
Rated operating voltage	250VAC	
UL/CSA and IEC/EN/BS 60947-5-1 designation	5A 250VAC AC1 /B300; 5A 30VDC	
Overload category	III	
DIGITAL INPUTS		
Number and type of inputs	4 negative (NPN)	
Input voltage	24VDC isolated	
Input current	7mA	
SUPPLY/VOLTAGE MEASURING CIRCUIT CONNECTIONS		
Type of terminals	Screw - removable	
Number of terminals	2 for power supply; 5 for voltage control	
Conductor section (min...max)	0.2...2.5mm ² (24...12AWG)	
Tightening torque	0.5Nm (4.5lb.in)	
CURRENT MEASURING CIRCUIT CONNECTIONS		
Type of terminal	Screw - fixed	
Number of terminals	6 for external CT connections	
Conductor section (min...max)	0.2...4mm ² (26...10AWG)	
Tightening torque	0.8Nm (7lb.in)	
RELAY OUTPUT CONNECTIONS		
Type and (number) of terminals	Screw - removable (3)	
Conductor section (min...max)	0.2...2.5 mm ² (24...12AWG)	
Tightening torque	0.5Nm (4.5lb.in)	
INPUT CONNECTIONS – Input terminals		
Type and (number) of terminals	Screw - removable (4)	
Conductor section (min...max)	0.2...1.5 mm ² (28...14AWG)	
Tightening torque	0.18Nm (1.7lb.in)	
INPUT CONNECTIONS – COM and auxiliary voltage terminals		
Type and (number) of terminals	Screw - removable (3)	
Conductor section (min...max)	0.2...2.5 mm ² (24...12AWG)	
Tightening torque	0.5Nm (4.5lb.in)	
HOUSING		
Material	Polyamide	
Version	Flush mount 96x96mm / 3.78x3.78"	



- Level monitoring relays for electrically conductive liquids
- Modular and plug-in versions
- Adjustable 2.5...200kΩ sensitivity
- Single and three-pole probes
- Float switches
- Start-up priority change relays.

	SEC. - PAGE
Level monitoring relays	
Modular version for conductive liquids	20 - 3
Plug-in version for conductive liquids	20 - 5
Probes, electrode holders and electrodes	20 - 6
Float switches	20 - 7
Float switches for grey water	20 - 7
Float switches for drinking water	20 - 8
Float switches for dirty water	20 - 8
Start-up priority change relays	
Modular version	20 - 9
Plug-in version	20 - 9
Accessories	20 - 9
Dimensions	20 - 10
Wiring diagrams	20 - 11
Technical characteristics	20 - 14



Page 20-3

LEVEL CONTROL RELAYS

- For conductive liquids
- Single, dual or multivoltage
- Emptying or filling functions
- Multifunctions
- Automatic reset
- Modular and plug-in versions.



Page 20-6

PROBES, ELECTRODES AND ELECTRODE HOLDERS

- Single pole
- Three pole.



Page 20-7

FLOAT SWITCHES

- Versions for grey water, drinking water and dirty water
- Versions with PVC and Neoprene cable
- Emptying or filling functions.



Page 20-9

START-UP PRIORITY CHANGE RELAYS

- 2 outputs
- Single or multivoltage
- Modular and plug-in versions.



LEVEL CONTROL RELAYS

START-UP PRIORITY CHANGE RELAYS FOR 2 MOTORS

Description	LEVEL CONTROL RELAYS						START-UP PRIORITY CHANGE RELAYS FOR 2 MOTORS		
	LVM20	LVM25	LVM30	LVM40	LV1E	LV2E	LVMP05	LVMP10	CSP2E
Modular version	●(2U)	●(1U)	●(3U)	●(3U)			●(1U)	●(3U)	
Plug-in version					● (8 pin)	● (11 pin)			● (11 pin)
3 detecting electrodes (MIN, MAX and COM)	●	●	●		●	●			
5 detecting electrodes (MIN1, MAX1, MIN2, MAX2 and COM)				●					
Sensitivity adjustment 2.5...50kΩ	●		●						
Sensitivity adjustment 2.5...100kΩ		●							
Sensitivity adjustment 2.5...200kΩ				●					
Fixed sensitivity: 7...8kΩ					●	●			
Adjustable sensitivity full-scale value 25-50-100-200 kΩ				●					
Separate sensitivity adjustment for MAX probe (foam detection)				●					
Emptying function	●	●	●	●	●	●			
Filling function		●	●	●					
Emptying function with MIN and/or MAX alarm				●					
Filling function with MIN and/or MAX alarm				●					
Emptying function with pump priority change				●					
Filling function with pump priority change				●					
Tank filling, well drawing functions and alarm				●					
Filling-emptying adjustment selector		●	●						
Programming selector for 5 different functions				●					
Motor start-up priority change							●		
Motor start-up priority change with stand-by motor function								●	●
Page	20-3			20-4	20-5		20-9		



Some permitted liquid substances				Liquid substances not permitted
Type of liquid	Resistivity kΩcm	Type of liquid	Resistivity kΩcm	
Drinking water	5...10	Milk	~1	<ul style="list-style-type: none"> • Purified water • Deionised water • Petrol • Oil • Liquid gases • Paraffin • Ethylene glycol • Paints • Liquids with a high percentage of alcohol
Well water	2...5	Whey	~1	
River water	2...15	Fruit juices	~1	
Rainwater	15...25	Vegetable juices	~1	
Sludge	0.5...2	Soups	~1	
Seawater	~0.03	Wine	~2.2	
Salt water	~2.2	Beer	~2.2	
Natural/hard water	~5	Coffee	~2.2	
Chlorinated water	~5	Suds	~18	
Condensed water	~18			

N.B. The resistivity values in the table are purely indicative.

Single-voltage relay



LVM20...

Order code	Auxiliary supply voltage	Type of output contact	Qty per pack	Wt
	[V] 50/60Hz	4 ¹	n°	[kg]
Emptying function. Automatic reset.				
LVM20A024	24VAC	1 C/O (SPDT)	1	0.215
LVM20A127	110...127VAC	1 C/O (SPDT)	1	0.215
LVM20A240	220...240VAC	1 C/O (SPDT)	1	0.215
LVM20A415	380...415VAC	1 C/O (SPDT)	1	0.215

Operational characteristics

- Used with 3 sensing electrodes, MIN, MAX and COM
- 2.5...50kΩ adjustable sensitivity
- Double insulation between each supply, electrodes and output relay circuits
- Fixed probe signal delay: <1s
- Green LED indicator for power on
- Red LED indicator for output relay state
- Modular DIN 43880 housing (2 modules)
- IEC degree of protection: IP40 on front (only when mounted in housing or electric board with IP40); IP20 on terminals.

Certifications and compliance

Certifications obtained: UL Listed, EAC, for USA and Canada (cULus-File E93601), as Auxiliary Devices - Level control relays.

Compliant with standards: IEC/EN/BS 60255-27, IEC/EN/BS 61000-6-2, IEC/EN/BS 61000-6-3, UL508, CSA C22.2 no. 14.

Probes and electrode holders

Use probes and electrode holders type: 11SN1/31PS31/31PS3S/31SCM/31CGL or similar (see page 20-6).

Multi-voltage relay



LVM25240

Order code	Auxiliary supply voltage	Type of output contact	Qty per pack	Wt
	[V] 50/60Hz	4 ¹	n°	[kg]
Emptying or filling functions. Automatic reset.				
LVM25240	24...240VAC/DC	1 C/O (SPDT)	1	0.095

Operational characteristics

- Used with 3 sensing electrodes, MIN, MAX and COM
- 2.5...100kΩ adjustable sensitivity
- Insensitivity to stray electrode-cable capacitance
- Programming selector for emptying or filling function with fail-safe operation
- Double insulation between each supply, electrodes and output relay circuits
- Fixed probe signal delay: <1s
- Green LED indicator for power on
- Red LED indicator for output relay state
- Modular DIN 43880 housing (1 module)
- IEC degree of protection: IP40 on front (only when mounted in housing or electric board with IP40); IP20 on terminals.

Certifications and compliance

Certifications obtained: UL Listed, for USA and Canada (cULus-File E93601), as Auxiliary Devices - Level control relays, EAC.

Compliant with standards: IEC/EN/BS 60255-27, IEC/EN/BS 60255-26, UL508, CSA C22.2 n° 14.

Probes and electrode holders

Use probes and electrode holders type: 11SN1/31PS31/31PS3S/31SCM/31CGL or similar (see page 20-6).



LVMKIT25

Order code	Description	Qty per pack	Wt
		n°	[kg]
Level control relay LVM25 240 and SN1 electrodes kit.			
LVMKIT25	Level control relay LVM25240 and two 11SN1 probes	1	0.192

Operational characteristics

- Used with 3 sensing electrodes, MIN, MAX and COM
- 2.5...50kΩ adjustable sensitivity
- Programming selector for emptying or filling function with fail-safe operation
- Double insulation between each supply, electrodes and output relay circuits
- Adjustable probe signal delay: 1...10s or pump start delay: 0...300s
- Green LED indicator for power on
- Red LED indicator for output relay state
- Modular DIN 43880 housing (3 modules)
- IEC degree of protection: IP40 on front (only when mounted in housing or electric board with IP40); IP20 on terminals.

Certifications and compliance

Certifications obtained: UL Listed, for USA and Canada (cULus-File E93601), as Auxiliary Devices - Level control relays, EAC.

Compliant with standards: IEC/EN/BS 60255-27, IEC/EN/BS 61000-6-2, IEC/EN/BS 61000-6-3, UL508, CSA C22.2 n° 14.

Probes and electrode holders

Use probes and electrode holders type: 11SN1/31PS31/31PS3S/31SCM/31CGL or similar (see page 20-6).

Dual-voltage relay



LVM30...

Order code	Auxiliary supply voltage	Type of output contact	Qty per pack	Wt
	[V] 50/60Hz	4 ¹	n°	[kg]
Emptying or filling functions. Automatic reset.				
LVM30A240	24/220...240VAC	2 C/O (SPDT)	1	0.315
LVM30A415	110...127VAC 380...415VAC	2 C/O (SPDT)	1	0.315

Single-voltage multifunction relay



LVM40...

FUNCTIONS

A- Emptying with MIN and/or MAX alarms.

B- Filling with MIN and/or MAX alarms.

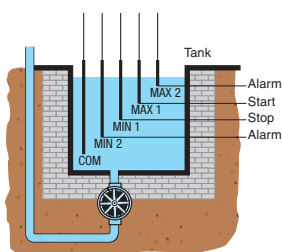

EXAMPLE OF EMPTYING OPERATION

To achieve this type of operation, two electrodes are used to control the liquid between the fixed limits using MIN1 and MAX1 and two alarm levels using MIN2 and MAX2. When one of the alarm electrodes is wet, the alarm relay is de-energised.

The alarm can be caused by pump malfunction, insufficient pump delivery capacity, MAX control level failure or MIN level electrode shorted.

With a proper connection, only the MIN alarm or MAX alarm can be activated or neither of the two can be activated so the relative output contacts can be used for pump control.

C- Emptying with pump priority change.

D- Filling with pump priority change.

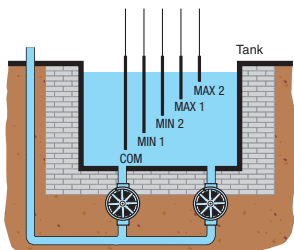

EXAMPLE OF EMPTYING OPERATION

This operation is obtained by using four electrodes positioned at four different levels and two relay outputs to control two pumps. For example, one can place the four electrodes, MIN1, MIN2, MAX1 and MAX2, in increasing order from the lowest to the highest levels and must control the tank emptying. Usually the level is controlled between the MIN1 and MAX1 levels by starting one of the two pumps. This case is different so the pumps can be maintained at the best efficiency and optimise their wear. When the liquid wets the MAX2 level and because the first pump is faulty or else a higher delivery capacity is needed, the second stand-by pump is activated to back up the first pump. When the liquid lowers and no longer wets the MIN2 level, the second pump is stopped and then when the MIN1 level is no longer wet, the first pump is stopped too.

E- Tank filling and well drawing with alarm.

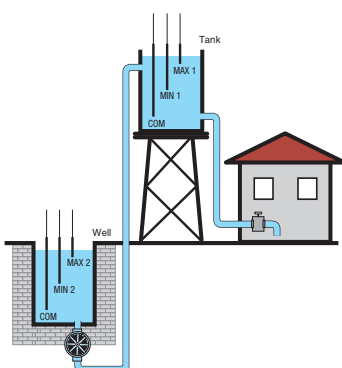

EXAMPLE

Two electrodes are used in this operation to control the tank level and another two for the well. One relay is used to activate the pump while the other for dry running / no water alarm.

When the well liquid wets the MAX2 level and the liquid wets the MIN1 tank level, the tank-filling pump is activated.

When the tank MAX1 level is wet, the pump is stopped. During the tank filling, the pump could stop before the MAX1 level is wet because the well MIN2 level is no longer wet.

Should the tank MIN1 level no longer be wet at which the pump should restart but the well MIN2 level is also no longer wet, then the alarm relay is de-energised.

Order code	Auxiliary supply voltage	Type of output contacts	Qty per pack	Weight
	[V] 50/60Hz	①	n°	[kg]

Multifunction Automatic reset.

LVM40A024	24VAC	1+1NO	1	0.278
LVM40A127	110...127VAC	1+1NO	1	0.278
LVM40A240	220...240VAC	1+1NO	1	0.278
LVM40A415	380...415VAC	1+1NO	1	0.278

① Two relay outputs; one with C/O (SPDT) and one with N/O (SPST).

Operational characteristics

- Use with 5 sensing electrodes, MIN1, MAX1, MIN2, MAX2 and COM
- 2.5...200kΩ adjustable sensitivity
- Adjustable sensitivity full-scale value: 25-50-100-200kΩ
- Separate sensitivity adjustment of MAX electrodes for foam detection
- Insensitivity to stray electrode-cable capacitance
- Programming selector for 5 different functions:
 - Emptying function and alarms (pos. A)
 - Filling function and alarms (pos. B)
 - Emptying function with pump priority start-up change (pos. C)
 - Filling function with pump priority start-up change (pos. D)
 - Well draining and tank filling and alarms (pos. E)
- Double insulation between each supply, electrodes and output relay circuits
- Adjustable probe signal delay: 1...10s
- Adjustable pump start delay: 0...30min
- Green LED indicator for power on
- Red LED indicators for output relay and electrode state
- Modular DIN 43880 housing (3 modules)
- IEC degree of protection: IP40 on front (only when mounted in housing or electric board with IP40); IP20 on terminals.

Certifications and compliance

Certifications obtained: UL Listed, for USA and Canada (cULus-File E93601), as Auxiliary Devices - Level control relays, EAC.

Compliant with standards: IEC/EN/BS 60255-27, IEC/EN/BS 61000-6-2, IEC/EN/BS 61000-6-3, UL508, CSA C22.2 n° 14.

Probes and electrode holders

Use probes and electrode holders type:

11SN1/31PS31/31PS3S/31SCM/31CGL or similar (see page 20-6).

Single-voltage relay



31LV1E...

Order code	Auxiliary supply voltage	Type of output contact	Qty per pack	Wt
	[V] 50/60Hz	1	n°	[kg]

Emptying function.
Automatic reset.

31LV1E24	24VAC	1 C/O (SPDT)	1	0.263
31LV1E110	110...120VAC	1 C/O (SPDT)	1	0.263
31LV1E230	220...240VAC	1 C/O (SPDT)	1	0.263
31LV1E400	380...415VAC	1 C/O (SPDT)	1	0.263

Operational characteristics

- Used with 3 sensing electrodes, MIN, MAX and COM
- 7...8kΩ fixed sensitivity
- Red LED indicator for output relay state
- Max. relay-electrode cable length: 500m/547yd single-core, double insulated cables
- Mounting on 35mm/1.38" (IEC/EN/BS 60715) DIN rail or 8-pin plug-in housing
- 8-pin plug-in housing (socket 31S8, see page 20-9)
- IEC degree of protection: IP30.

Certifications and compliance

Certifications obtained: EAC.
Compliant with standards: IEC/EN/BS 60255-27.

Probes and electrode holders

Use probes and electrode holders type: 11SN1/31PS31/31PS3S/31SCM/31CGL or similar (see page 20-6).

Dual-voltage relay



31LV2E...

Order code	Auxiliary supply voltage	Type of output contact	Qty per pack	Wt
	[V] 50/60Hz	1	n°	[kg]

Emptying function.
Automatic reset.

31LV2E48	24/48VAC	1 C/O (SPDT)	1	0.266
31LV2E220	110...120VAC/ 220...240VAC	1 C/O (SPDT)	1	0.266
31LV2E400	220...240VAC/ 380...415VAC	1 C/O (SPDT)	1	0.266

Operational characteristics

- Used with 3 sensing electrodes, MIN, MAX and COM
- 7...8kΩ fixed sensitivity
- Red LED indicator for output relay state
- Max. relay-electrode cable length: 500m/547yd single-core, double insulated cables
- Mounting on 35mm/1.38" (IEC/EN/BS 60715) DIN rail or 11-pin plug-in housing
- 11-pin plug-in housing (socket 31S11, see page 20-9)
- IEC degree of protection: IP30.

Certifications and compliance

Certifications obtained: EAC.
Compliant with standards: IEC/EN/BS 60255-27.

Probes and electrode holders

Use probes and electrode holders type: 11SN1/31PS31/31PS3S/31SCM/31CGL or similar (see page 20-6).

Probes and electrode holders



11SN1



31SCM...



31CGL125...



31PS31



31PS3S

Electrodes



31ASTA...

Order code	Probe included	Probe length [mm/in]	Qty per pack n°	Weight [kg]
Single pole electrodes.				
11SN1	Yes	1000/39.9"	10	0.050
31SCM04	Yes	43/1.7"	1	0.060
31SCM50	Yes	500/19.7"	1	0.115
31SCM100	Yes	1000/39.4"	1	0.162
31CGL1253	Yes	327/12.9"	1	0.126
31CGL1255	Yes	500/19.7"	1	0.158
31CGL1257	Yes	700/27.6"	1	0.208
31CGL12510	Yes	1000/39.4"	1	0.281
Three pole electrode.				
31PS31	Yes	300/11.8"	1	0.120
Electrode holder (for 3 rod probes).				
31PS3S	No	—	1	0.184

① Total electrode length.

General characteristics

11SN1 SINGLE POLE PROBES

A single pole probe used for level control in wells or storage tanks. It comprises of an AISI 303 stainless steel electrode, a plastic (PPOX) holder and a cable gland.

A seal ring and the tightening of the cable gland PG7 prevent water from entering the cable terminal connector and causing its oxidation.

Cable connection: screw.

The external cable diameter must be 2.5 to 6mm/Ø0.1 to 0.24" to warrant perfect sealing.

Maximum connection cable section: 2.5mm²

Maximum operating temperature: +60°C.

Application: tanks and deep wells.

31SCM... PROBES

A single pole probe used for level control on boilers, autoclaves and in general where pressure (10bar maximum) and high temperature (+100°C maximum) are present. It comprises of an AISI 303 stainless steel electrode embedded in an aluminium oxide body and a 3/8" GAS threaded metal support holder.

Cable connection: threaded rod with nut.

Application: tanks, pressurised tanks and boilers.

31CGL125... PROBES

A single pole probe with AISI 302 electrode, used for level control on boilers and autoclaves and in general wherever pressure is maximum up to 10bar.

Maximum operating temperature: +180°C.

Threaded coupling: 3/8" GAS.

Cable connection: threaded rod with nut.

Application: tanks, pressurised tanks and boilers.

31PS31 PROBE

A small electrode holder, complete with three AISI 304 stainless steel probes.

Particularly suited to small containers whenever pressure is maximum up to 2bar.

Maximum operating temperature: +70°C.

Threaded coupling: 1/2" GAS.

Faston termination; related lugs supplied.

Application: tanks and automatic dispensers.

31PS3S ELECTRODE HOLDER

A thermoset resin electrode holder to be used with three probes (rods probes to be ordered separately) and complete with terminal cover.

Maximum operating temperature: +100°C.

2" GAS threaded coupling.

Cable connection: screw.

Application: tanks.

Certification and compliance

Certification obtained: EAC.

Compliant with standards: IEC/EN/BS 60255-27.

Order code	Rod probe length [mm/in]	Qty per pack n°	Weight [kg]
For 31SCM... probes.			
31ASTA460MM4	460/18.11"	1	0.053
31ASTA960MM4	960/37.8"	1	0.103
For 31PS3S electrode holder.			
31ASTA460MM6	460/18.11"	1	0.100
31ASTA960MM6	960/37.8"	1	0.210

General characteristics

Stainless steel AISI 304 electrodes with 4M or 6M threaded extremity suitable as extensions for 31SCM... probe or as rod probe for 31PS3S electrode holder.

For connecting 31SCM... probes with electrode extension unit (31ASTA...MM4), see page 20-9.

Certification

Certification obtained: EAC.

For grey water



Order code	Cable material	Cable length	Counterweight included	Qty	Wt
		[m]		n°	[kg]
LVFSP1W03	PVC	3	Yes	1	0.610
LVFSP1W05	PVC	5	Yes	1	0.830
LVFSP1W10	PVC	10	Yes	1	1.410
LVFSP1W15	PVC	15	Yes	1	1.930
LVFSP1W20	PVC	20	Yes	1	2.380
LVFSN1W03	Neoprene	3	Yes	1	0.640
LVFSN1W05	Neoprene	5	Yes	1	0.880
LVFSN1W10	Neoprene	10	Yes	1	1.510
LVFSN1W15	Neoprene	15	Yes	1	2.080
LVFSN1W20	Neoprene	20	Yes	1	2.480

Filling function

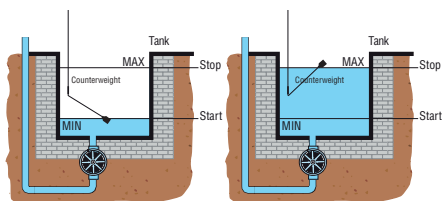

This function is achieved by connecting the black and blue float terminals. The level regulator contact closes the lower circuit at minimum level and opens the circuit when the float reaches the upper maximum level. The MIN and MAX levels can be adjusted by varying the distance between counterweight and float.

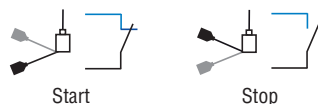

Emptying function

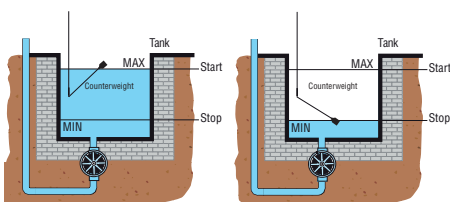

This function is achieved by connecting the black and brown float terminals. The level regulator contact closes the upper circuit at maximum level and opens the circuit when the float reaches the lower minimum level. The MIN and MAX levels can be adjusted by varying the distance between counterweight and float.



General characteristics

Float switches are used in the automation of electrical equipment, such as: pumps, solenoid valves, alarms, motorised sluice gates, etc. All versions feature an internal changeover contact operated in accordance with the level of liquid where the float is located. The cables used are high-quality and offer excellent mechanical or chemical resistance over time.

The cables are 3x1 type, that is 3 wires with section 1mm². This allows the user to choose the filling and emptying function during regulator wiring.

They are used for the civil and industrial control of levels of grey water, e.g. rainwater, groundwater or cooling water from industry. They are available with PVC and neoprene cables of various lengths.

Operational characteristics

- Upper switching angle: 30° ±5°
- Lower switching angle: 30° ±5°
- 130g external counterweight included
- Float casing material: polypropylene
- Cable A05 VV-F3X1 (PVC) available in lengths of 3, 5, 10, 15 and 20m/3.28, 5.47, 10.94, 16.40 and 21.87yd and cable H07 RN-F3X1 (Neoprene) available in lengths of 3, 5, 10, 15 and 20m/3.28, 5.47, 10.94, 16.40 and 21.87yd
- Rated cable diameter: 9mm/0.35" (PVC and Neoprene)
- Relay with changeover contact 10(8)A 250VAC 50/60Hz
- Maximum installation depth: 20m/21.26yd
- Maximum pressure: 2bar
- Operating temperature: 0...+50°C
- Storage temperature: -20...+80°C
- IEC degree of protection: IP68
- Insulation class: II.

Certifications and compliance

Certifications: TÜV-SUD.
Compliant with standards: IEC/EN/BS 60730-1, IEC/EN/BS 60730-2-15.

For drinking water



LVFSA1D...

Order code	Cable material	Cable length	Counter-weight included	Qty	Wt
		[m]		n°	[kg]
LVFSA1D03	PVC ACS+AD8	3	Yes	1	0.630
LVFSA1D05	PVC ACS+AD8	5	Yes	1	0.850
LVFSA1D10	PVC ACS+AD8	10	Yes	1	1.430
LVFSA1D15	PVC ACS+AD8	15	Yes	1	1.950
LVFSA1D20	PVC ACS+AD8	20	Yes	1	2.400

Filling function

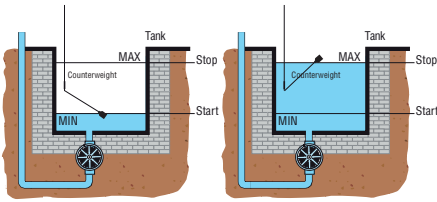

This function is achieved by connecting the black and blue float terminals. The level regulator contact closes the lower circuit at minimum level and opens the circuit when the float reaches the upper maximum level. The MIN and MAX levels can be adjusted by varying the distance between counterweight and float.

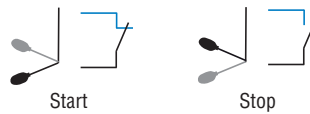

Emptying function

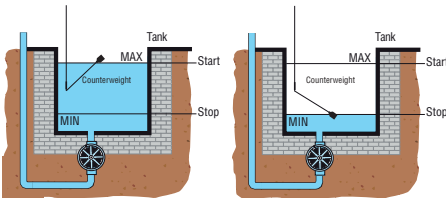

This function is achieved by connecting the black and brown float terminals. The level regulator contact closes the upper circuit at maximum level and opens the circuit when the float reaches the lower minimum level. The MIN and MAX levels can be adjusted by varying the distance between counterweight and float.

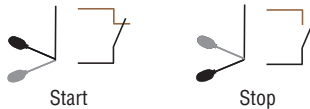

For dirty water



Order code	Cable material	Cable length	Counter-weight	Qty	Wt
		[m]		n°	[kg]
LVFSN1B05	Neoprene	5	Internal	1	1.250
LVFSN1B10	Neoprene	10	Internal	1	1.860
LVFSN1B15	Neoprene	15	Internal	1	2.460
LVFSN1B20	Neoprene	20	Internal	1	3.060

Filling function

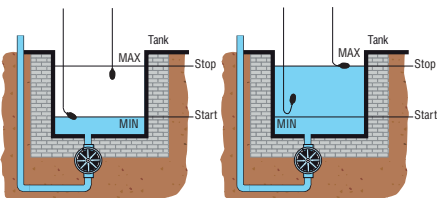

This function uses two floats and is achieved by connecting the black and blue float terminals. The MIN and MAX levels can be adjusted by varying the position of the floats.

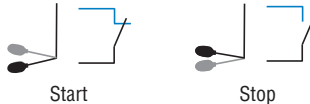

Emptying function

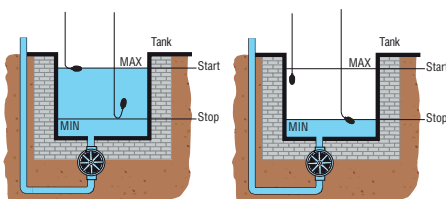

This function uses two floats and is achieved by connecting the black and brown float terminals. The MIN and MAX levels can be adjusted by varying the position of the floats.

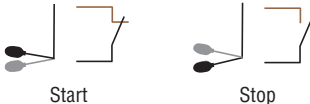

It is possible to use even a single float for black water, adjusting the level in a fixed range of 10cm max, a solution which is not advisable for turbulent waters.

General characteristics

Float switches LVFSA A1 D type are suitable for drinking water and foodstuffs applications such as aqueducts, fountains, aquariums, drinks, fish hatcheries, swimming pools, etc. They are realised with a non-toxic polypropylene outer shell, a stainless steel untreated sphere, and an AD8 cable with health certification ACS (Attestation de Conformité Sanitaire) with outer sheath with PVC suitable for drinkable water immersion and use with food products. They are provided with stainless steel counter weight AISI 316. All versions, which differ in the length of the cable, feature an internal changeover contact operated in accordance with the level of liquid where the float is located. The cables are 3x1 type, that is 3 wires with section 1mm². This allows the user to choose the filling and emptying function during regulator wiring.

Operational characteristics

- Upper switching angle: 30° ±5°
- Lower switching angle: 30° ±5°
- Stainless steel counterweight AISI 316 included
- Float casing material: polypropylene
- PVC cable ACS + AD8 certified
- Microswitch with changeover contact: 10(8)A 250VAC 50-60Hz
- Maximum installation depth: 20m/21.87yd
- Maximum pressure: 2bar
- Operating temperature: 0...+50°C
- Storage temperature: -20...+80°C
- Degree of protection: IP68
- Insulation class: II.

Certifications and compliance

Certifications: Health certification ACS (Attestation de Conformité Sanitaire) for the cable. Compliant with standards: IEC/EN/BS 60730-1, IEC/EN/BS 60730-2-15.

General characteristics

These float switches are used for the civil and industrial control of levels of dirty water, e.g. sewage or waste water from industry. The float switches comprises of a one-piece external blow-moulded polypropylene casing, with fixed internal counterweight located in the cable exit area. The regulator contact is positioned centrally in its own watertight chamber. This is insulated from the external casing by injecting closed-cell foam. This solution further increases protection against moisture leakage and heat insulates the watertight chamber housing the contact, eliminating the creation of condensation.

Operational characteristics

- Upper switching angle: 30° ±5°
- Lower switching angle: 20° ±5°
- Internal counterweight
- Float casing material: polypropylene
- Cable H07 RN-F3X1 (Neoprene) available in lengths of 5, 10, 15 and 20m/5.47, 10.94, 16.40 and 21.87yd
- Rated cable diameter: 9mm/0.35"
- Relay with changeover contact 10(4)A 250VAC 50/60Hz
- Maximum installation depth: 100m/109.36yd
- Maximum pressure: 10bar
- Operating temperature: 0...+40°C
- Storage temperature: -20...+80°C
- IEC degree of protection: IP68
- Insulation class: II.

Certifications and compliance

Certifications: TÜV-SUD. Compliant with standards: IEC/EN/BS 60730-1, IEC/EN/BS 60730-2-15.



Modular version



LVMP05



LVMP10...

Order code	Auxiliary supply voltage	Type of output contacts	Qty per pack	Weight
	[V]	↘	n°	[kg]
2 outputs. AC and DC supply voltage.				
LVMP05	24/48VDC 24...240VAC	2NO with same common	1	0.090
2 outputs. AC supply voltage. Possible starting of stand-by motor.				
LVMP10A024	24VAC	2 NO (SPST)	1	0.250
LVMP10A127	110...127VAC	2 NO (SPST)	1	0.250
LVMP10A240	220...240VAC	2 NO (SPST)	1	0.250
LVMP10A415	380...415VAC	2 NO (SPST)	1	0.250

General characteristics

Priority change relays are designed to balance the operating time and hence the wear of pumps, compressors, generators, when two units, primary and stand-by, are installed.

Operational characteristics

- Operating limits: 0.85...1.1 Ue
- Connection: permanent
- Green LED indicator for power on
- Red LED indicators for output relay state 1 for LVMP05, 2 for LVMP10
- Modular DIN 43880 housing (1 module LVMP05, 3 modules LVMP10)
- IEC degree of protection: IP40 on front (only when mounted in housing or electric board with IP40); IP20 on terminals.

Certifications and compliance

Certifications obtained: UL Listed, for USA and Canada (cULus-File E93601), as Auxiliary Devices - Automatic starting control, EAC.

Compliant with standards: IEC/EN/BS 60255-27, IEC/EN/BS 61000-6-2, IEC/EN/BS 61000-6-3, UL508, CSA C22.2 n° 14.

Plug-in version



31CSP2E...

Order code	Auxiliary supply voltage	Type of output contacts	Qty per pack	Weight
	[V] 50/60Hz	↘	n°	[kg]
2 outputs. AC supply voltage. Possible starting of stand-by motor.				
31CSP2E24	24VAC	2 NO (SPST)	1	0.150
31CSP2E110	110VAC	2 NO (SPST)	1	0.150
31CSP2E220	220VAC	2 NO (SPST)	1	0.150
31CSP2E230	230...240VAC	2 NO (SPST)	1	0.150

General characteristics

Priority change relays are designed to balance the operating time, and hence the wear of pumps, compressors, generators, when two units, primary and stand-by, are installed.

Operational characteristics

- Operating limits: 0.85...1.1 Ue
- Connection: permanent
- Voltage applied to input contacts: 15VDC not insulated at power supply
- Input contacts current consumption: about 1mA.
- 11-pin plug-in housing (see socket 31S11).
- IEC degree of protection: IP30.

Certifications and compliance

Certifications obtained: EAC.

Compliant with standards: IEC/EN/BS 60255-27, IEC/EN/BS 61000-6-2, IEC/EN/BS 61000-6-3.

Accessories



31RE213



31S8



31S11



31RE014

Order code	Description	Qty per pack	Weight
		n°	[kg]
31RE213	Coupler unit for 31SCM... with electrode extension ASTA...MM4	1	0.008
31S8	8-pin socket for screw fixing or mounting on 35mm/1.38" DIN rail (IEC/EN/BS 60715), used with LV1E... relay. Screw terminals	10	0.061
31S11	11-pin socket for screw fixing or mounting on 35mm/1.38" DIN rail (IEC/EN/BS 60715), used with LV2E... and CSP2E... relays. Screw terminals	10	0.064
31RE014	Relay-socket retention bracket; 31S8 or 31S11 types only	10	0.001

Operational characteristics

SOCKETS FOR INSTALLING PLUG-IN LEVEL CONTROL RELAYS.

- Max. wire section for sockets: 2x2.5mm²/2x14AWG
- Tightening torque: 0.8Nm/7.1lb.in
- Ratings: 10A - 400VAC.

Certifications and compliance

Certifications obtained: EAC.

Compliant with standards: IEC/EN/BS 61984, IEC/EN/BS 61210, IEC/EN/BS 60999-1.

LEVEL CONTROL AND START-UP PRIORITY CHANGE RELAYS

LVM25... - LVMP05

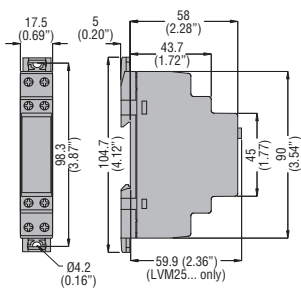

LVM20...

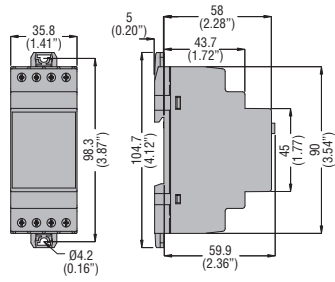

LVM30... - LVM40... - LVMP10

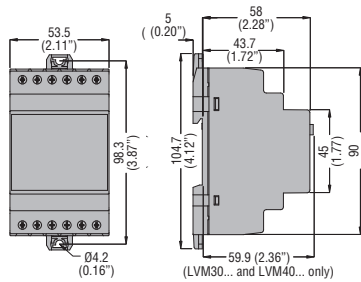

31LV1E... - 31LV2E... - 31CSP2E...

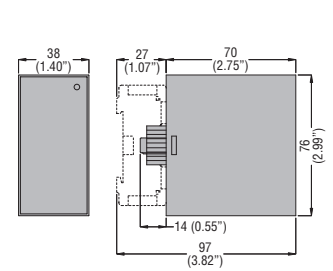

PROBES AND ELECTRODE HOLDERS FOR CONDUCTIVE LIQUIDS

11SN1

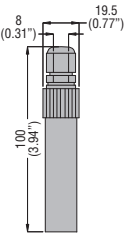

31SCM...

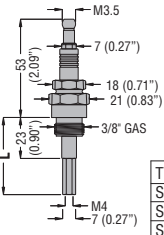

TYPE	L
SCM04	43 (1.69")
SCM50	500 (19.68")
SCM100	1000 (39.37")

31CGL125...

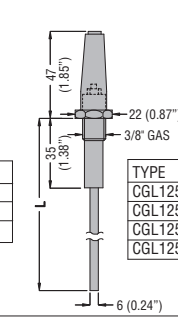

TYPE	L
CGL1253	327 (12.87")
CGL1255	500 (19.68")
CGL1257	700 (27.56")
CGL12510	1000 (39.37")

31PS31

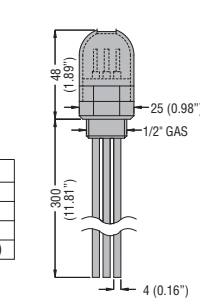

31PS3S

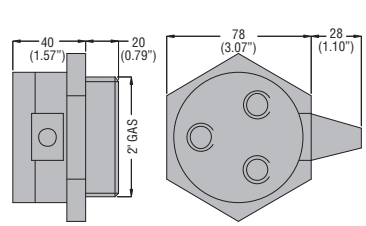

ELECTRODES

31ASTA460MM4 31ASTA960MM4

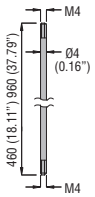

31ASTA460MM6 31ASTA960MM6

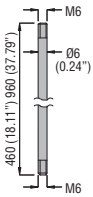

Coupler unit

31RE213

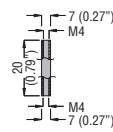

FLOAT SWITCHES

LVFS...W... LVFS...D...

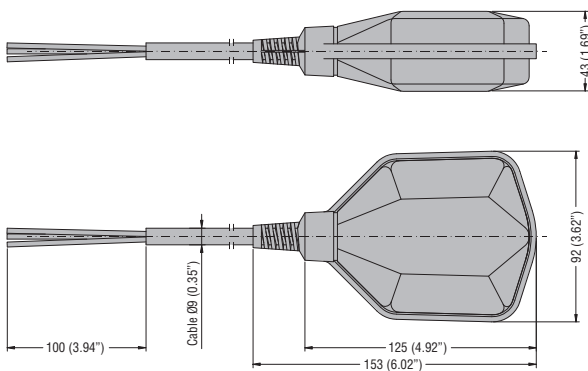

LVFSN1B...

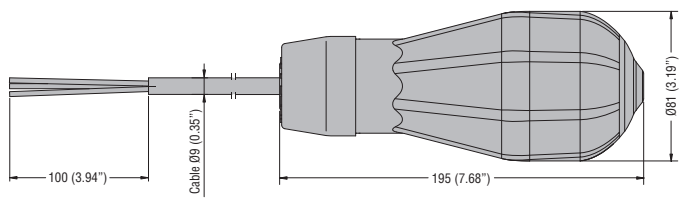

ACCESSORIES

31S8 - 31S11

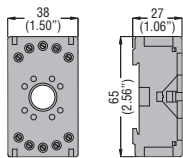

31RE014

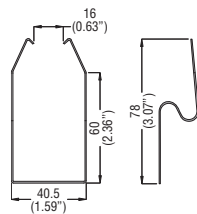

Emptying function

LVM20

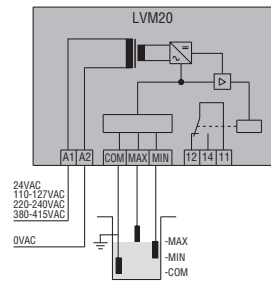

Emptying function with 3 electrodes

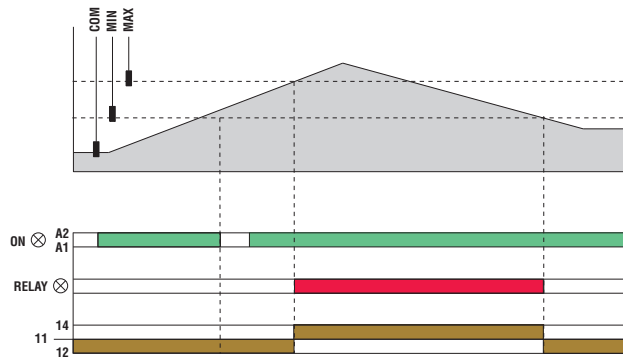

Emptying function with 2 electrodes

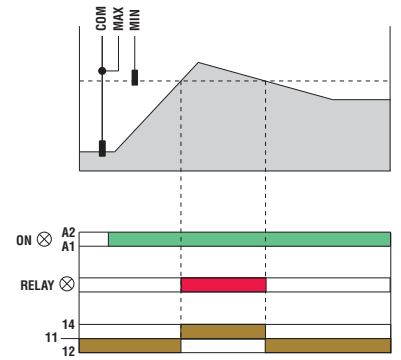

Emptying or filling functions

LVM25

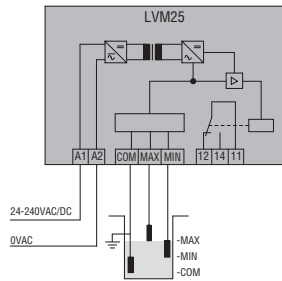

Emptying function (DOWN) Connection with 3 electrodes

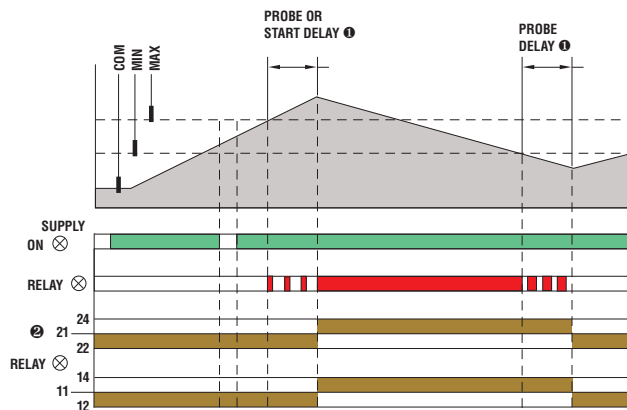

Connection with 2 electrodes

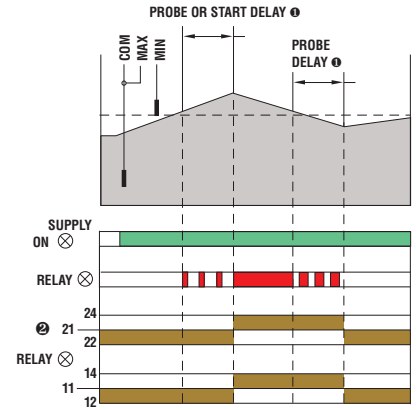

LVM30

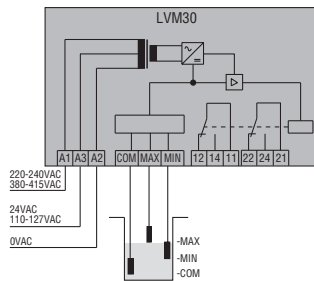

Filling function (UP) Connection with 3 electrodes

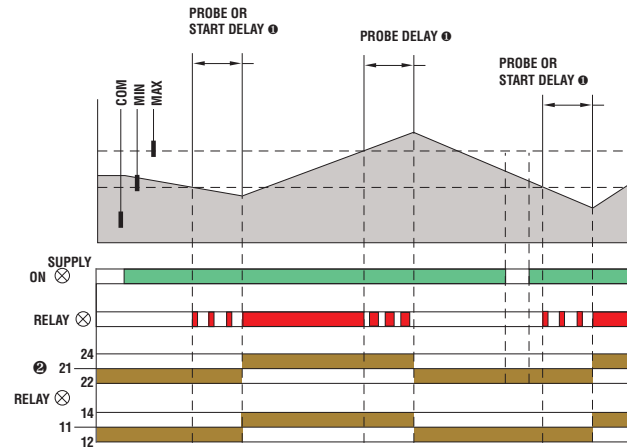

Connection with 2 electrodes

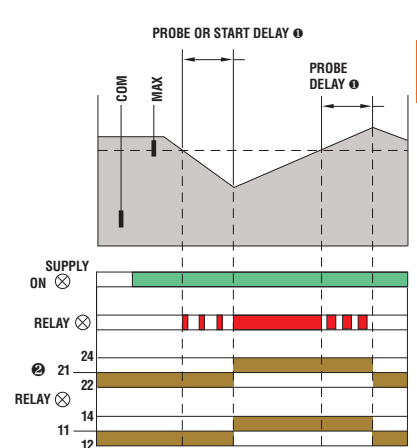

- ① Delay for LVM30 only.
- ② Changeover contact (SPDT) for LVM30 only.

Multifunctions.
LVM40

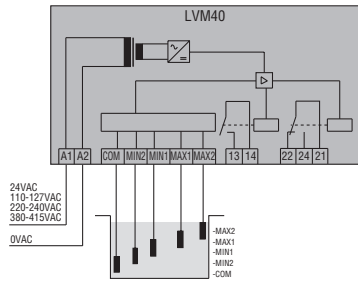

Emptying function + alarms

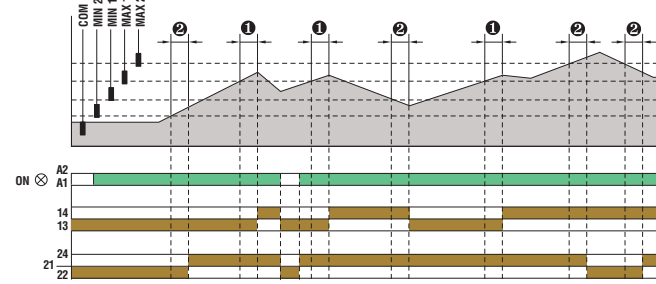

Filling function + alarms

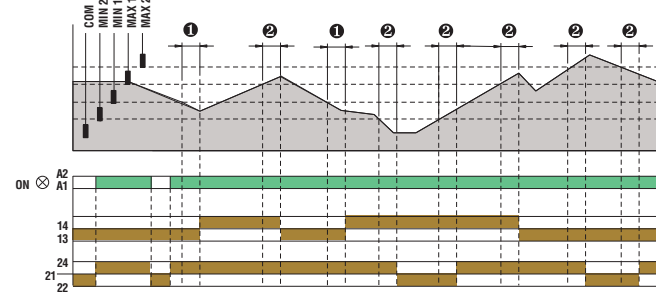

Emptying function + pump change

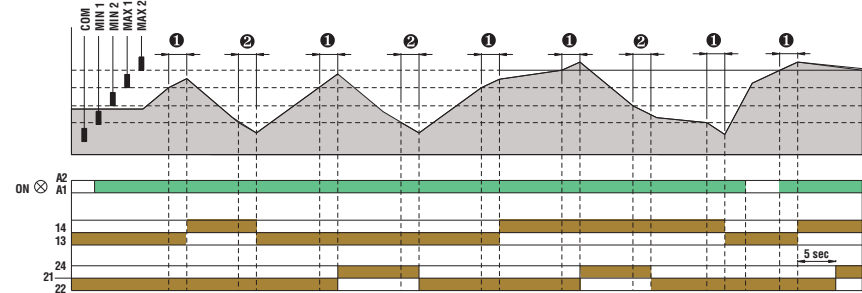

Filling function + pump change

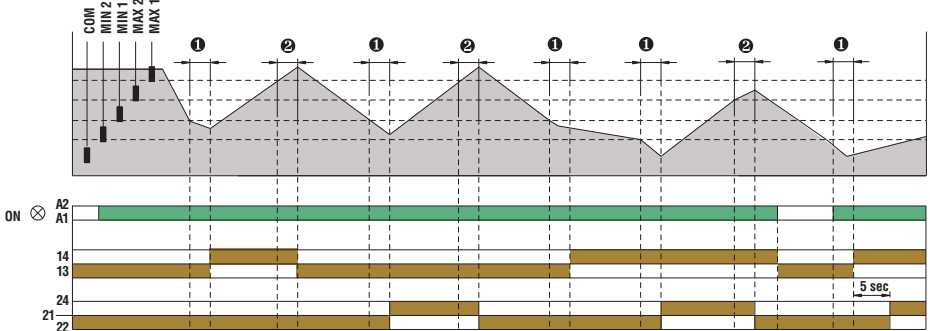

Filling tank and draining well function + alarm

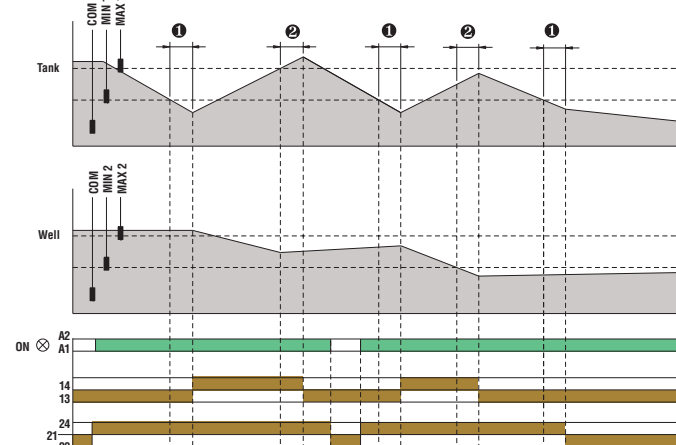

- ① Probe delay + start delay.
- ② Probe delay.

Emptying function

31LV1E

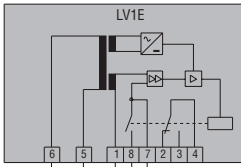

31LV2E

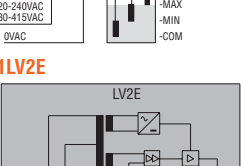

31LV2E

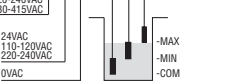

Emptying function with 3 electrodes

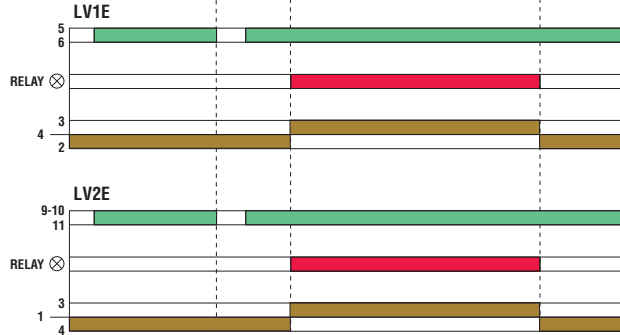
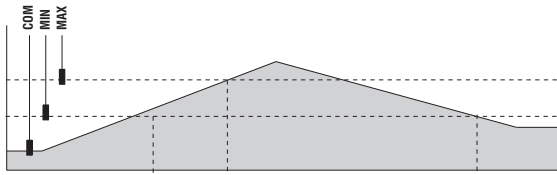

Emptying function with 2 electrodes

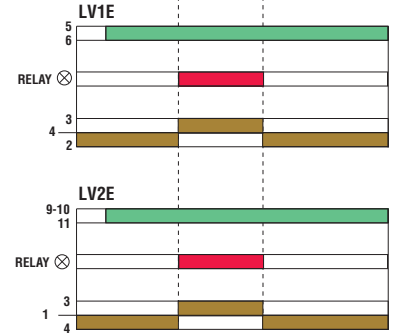
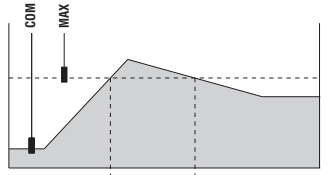

Priority change relays

LVMP05

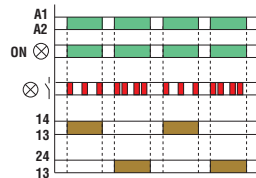
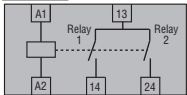

LVMP10

2-wire connection

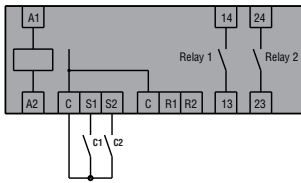

C1 = Primary
C2 = Secondary / Standby

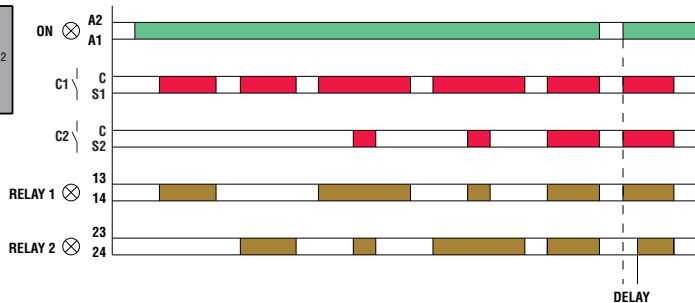

3-wire connection

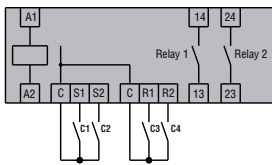

C1 = Start Primary
C2 = Start Standby
C3 = Stop Primary
C4 = Stop Standby

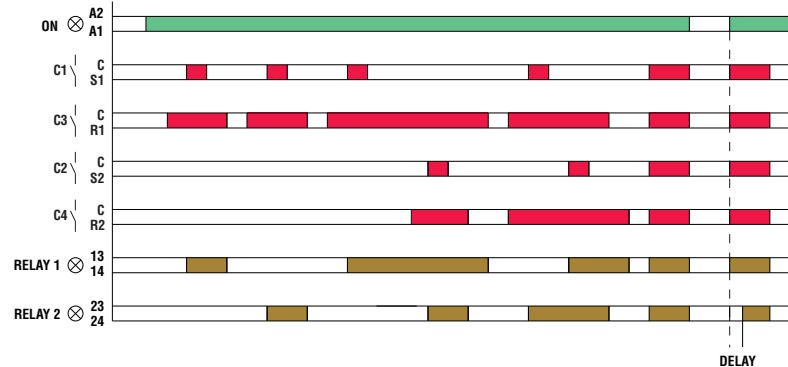

31CSP2E

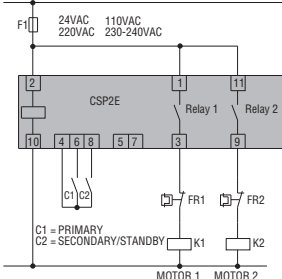

C1 = PRIMARY
C2 = SECONDARY/STANDBY

TYPE	LVM20...	LVM25...	LVM30...	LVM40...
DESCRIPTION	Modular Automatic reset			
Application (examples)	Single voltage Emptying function	Multi voltage Emptying or filling function	Dual voltage Emptying or filling function	Single voltage Multifunctions
Operating principle	Electrical conductivity of liquids			
AUXILIARY SUPPLY				
Rated supply voltage Us	24VAC 110...127VAC 220...240VAC 380...415VAC	24...240VAC/DC	24/220...240VAC 110...127/380...415VAC	24VAC 110...127VAC 220...240VAC 380...415VAC
Operating voltage range	0.85...1.1 Us; 50/60Hz ±5%			
Power consumption (maximum)	3.5VA	3VA	5.5VA	4.5VA
Power dissipation (maximum)	1.8W	1.2W	2.8W	2.8W
LEVEL ELECTRODES				
Number of connectable electrodes	3	3	3	5
Type of electrode	Electrode and electrode holders: SN1 / SCM / CGL / PS31 / PS3S or similar			
Electrode voltage	7.5VAC	10Vpp	7.5VAC	10Vpp
Sensitivity	2.5...50kΩ	2.5...100kΩ	2.5...50kΩ	2.5...200kΩ
TIME DELAYS				
Tripping time (minimum)	≤ 600ms	≤ 1s	1s	1s
Resetting time (minimum)	≤ 750ms	≤ 1s	1s	1s
Probe tripping delay	—	—	OFF...10s	1...10s
Relay energising delay	—	—	OFF...300s	0...30min
RELAY OUTPUTS				
Number of relays	1	1	2	2
Relay state	Normally de-energised, energises at tripping			
Contact arrangement	1 changeover / SPDT	1 changeover / SPDT	2 changeover / SPDT each	1 changeover / SPDT and 1 with 1 N/O - SPST
Rated utilisation voltage	250VAC			
Maximum switching voltage	400VAC			
IEC conventional free air thermal current Ith	8A			
UL/CSA and IEC/EN/BS 60947-5-1 designation	B300			
Electrical life (with rated load)	10 ⁵ cycles			
Mechanical life	30x10 ⁶ cycles			
Indications	1 green LED for power on 1 red LED for relay state	1 green LED for power on 1 red LED for relay state	1 green LED indicator for power on 1 red LED for relay state	1 green LED indicator for power on 2 red LEDs for relay state 2 red LEDs for probe state
INSULATION				
IEC rated insulation voltage Ui	415VAC	240VAC	415VAC	415VAC
IEC rated impulse withstand voltage Uimp	6kV	4kV	6kV	6kV
IEC power frequency withstand voltage	4kV	2kV	4kV	4kV
Double insulation Supply/relay/electrode	≤ 250VAC	≤ 250VAC ^①	≤ 250VAC	≤ 250VAC
CONNECTIONS				
Tightening torque maximum	0.8Nm (7lb.in; 7-9lb.in for UL/CSA)			
Conductor section min-max	0.2...4mm ² (24...12AWG; 18...12AWG for UL/CSA)			
AMBIENT CONDITIONS				
Operating temperature	-20...+60 °C			
Storage temperature	-30...+80 °C			
HOUSING				
Material	Self-extinguishing polyamide			
Typical configuration (examples)	LVM20 + n° 3 SN1 electrodes LVM30 + n° 3 SN1 electrodes		LVM25 + n° 3 SN1 electrodes LVM40 + n° 5 SN1 electrodes	
Maximum cable length	②			

① Double insulation between supply, electrodes and output relay circuit.

② Voltage applied to input contacts, not insulated at power supply.

③ Consult Technical support for more information; see contact Tel. +39 035-4282422 - E-mail: service@LovatoElectric.com.

	31LV1E...	31LV2E...	LVMP05	LVMP10	31CSP2E
	Plug-in		Modular	Modular	Plug-in
	Automatic resetting		—	—	—
	Single voltage	Dual voltage	Multistage	Single voltage	Single voltage
	Emptying function		Priority change relay for motors		
	Electrical conductivity of liquids		—		
	24VAC 110...120VAC 220...240VAC 380...415VAC	24/48VAC 110...120VAC/220...240VAC 220...240VAC/380...415VAC	24/48VDC 24...240VAC	24VAC 110...127VAC 220...240VAC 380...415VAC	24VAC [Ⓜ] 110VAC [Ⓜ] 220VAC [Ⓜ] 230/240VAC [Ⓜ]
	0.8...1.1 Us; 50/60Hz				
	5.5VA 2.8W		1.6VA 0.9W	4.8VA 3W	5VA 3W
	3		—	—	—
	Electrode and electrode holders: SN1 / SCM / CGL / PS31 / PS3S / or similar				
	9VAC (voltage between probes)				
	7...8 kΩ fixed				
	≤ 50ms		—	—	—
	≤ 100ms		—	—	—
	—		—	—	—
	—		—	—	—
	1		2	2	2
	Normally de-energised, energises at tripping				
	1 changeover contact / SPDT		2 N/O with same common	2 N/O - SPST	2 N/O - SPST
	220VAC 380VAC		250VAC	250VAC	250VAC
	5A		8A	8A	5A
	B300		B300	B300	B300
	2.5x10 ⁵ cycles 50x10 ⁶ cycles		10 ⁵ cycles 30x10 ⁶ cycles	10 ⁵ cycles 30x10 ⁶ cycles	10 ⁵ cycles 30x10 ⁶ cycles
	1 red LED for relay state		1 green LED for power on 1 red LED for relay state	1 green LED for power on 2 red LED for relays state	1 green/red LED for relay state
	415VAC		250VAC	415VAC	250VAC
	5kV		4kV	4kV	4kV
	2kV		2kV	2.5kV	2.5kV
	—				
	—		0.8Nm (7lb.in; 7-9lb.in for UL/CSA)		—
	—		0.2...4.0mm ² (24...12AWG; 18...12AWG for UL/CSA)		—
	-20...+60°C				
	-30...+80°C				
	Self-extinguishing polycarbonate		Self-extinguishing polyamide	Self-extinguishing polyamide	Self-extinguishing polycarbonate
	LV1E + n° 3 SN1 electrode		—	—	—
	LV2E + n° 2 SN1 electrodes + reset button		—	—	—
	500m/547yd single-core, double insulated cables		—	—	—

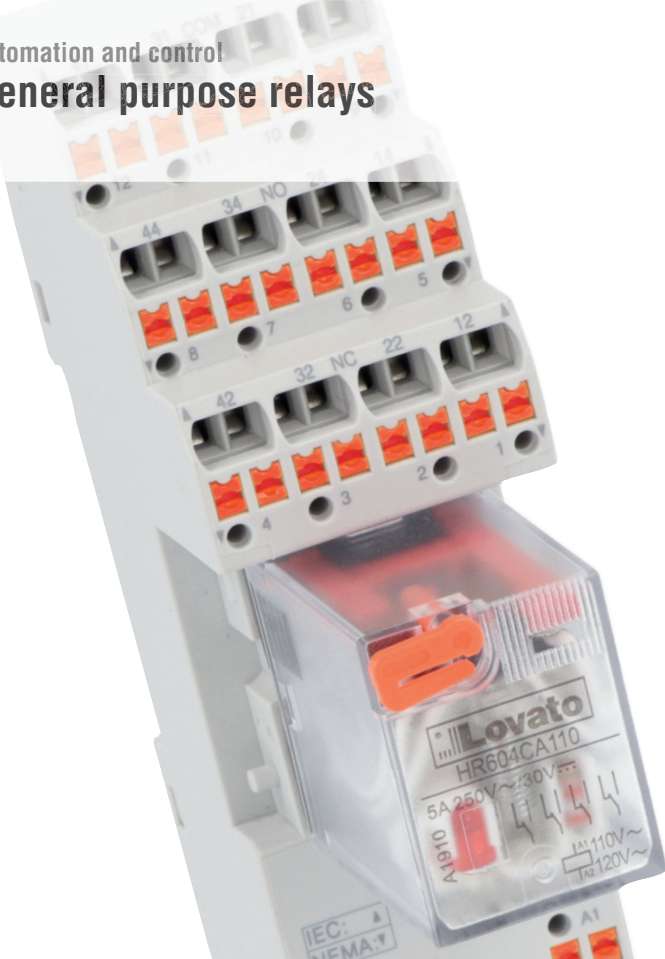

- Electromechanical and SSR (solid state relay) versions
- AC or DC coils
- Sockets with screw, spring or PIN for Printed Circuit Board terminals
- Relays with LED state indicator and mechanical actuator
- Parallel busbars and surge suppressor filters
- Power relays with Atex certificate.

General purpose relays

	SEC. - PAGE
Electromechanical slim relays	21 - 4
SSR (solid state relay) slim relays	21 - 4
Miniature relays	21 - 5
Miniature relays clear enclosure	21 - 6
Miniature relays with LED state indicator and mechanical actuator	21 - 6
Industrial relays with LED state indicator and mechanical actuator	21 - 7
8-pin and 11-pin industrial relays with LED state indicator and mechanical actuator	21 - 8
Power relays with Atex certificate	21 - 8

Dimensions	21 - 9
-------------------------	---------------

Wiring diagrams	21 - 10
------------------------------	----------------

Technical characteristics	21 - 12
--	----------------



Page 21-4

HR10

- Slim electromechanical relay with
- Socket width 6.2mm
- 1 changeover contact
- lth rated current 6A
- Sockets with built-in LED
- Sockets with screw or spring terminals
- Control voltage from 12 to 230VAC/DC
- 20 poles parallel busbars
- Available version with relay factory assembled on the socket.



Page 21-4

HR20

- Slim solid state relay (SSR)
- Socket width 6.2mm
- 1 solid-state (SSR) output
- Output current 2A in AC and 4A in DC
- Sockets with built-in LED
- Sockets with screw or spring terminals
- Control voltage 24VDC
- 20 poles parallel busbars
- High switching speed
- Theoretically infinite electrical life
- Zero crossing.



Page 21-5

HR30

- Miniature relay
- Socket width 15.8mm
- 1 or 2 changeover contacts
- lth rated current:
 - 1 contact: 10A (16A on PCB)
 - 2 contacts: 8A
- AC or DC control voltage
- Sockets with screw, spring or pins for PCB terminals
- 8 poles parallel busbars
- Small dimensions
- Can be used for direct mounting on PCB
- Snap-on surge suppressor filters.



Page 21-6

HR40

- Miniature relay in clear enclosure
- Socket width 15.8mm
- 1 or 2 changeover contacts
- lth rated current:
 - 1 contact: 10A (16A on PCB)
 - 2 contacts: 10A
- AC or DC control voltage
- Sockets with screw, spring or pins for PCB terminals
- 8 poles parallel busbars
- Clear enclosure for contacts visibility
- Can be used for direct mounting on PCB
- Snap-on surge suppressor filters.



Page 21-6

HR50

- Miniature relay with LED status indicator and mechanical actuator
- Socket width 15.8mm
- 1 or 2 changeover contacts
- lth rated current:
 - 1 contact: 10A (16A on PCB)
 - 2 contacts: 8A
- LED and mechanical status indicator
- Mechanical test actuator with latch option
- AC or DC control voltage
- Sockets with screw, spring or pins for PCB terminals
- 8 poles parallel busbars
- Can be used for direct mounting on PCB
- Snap-on surge suppressor filters.



Page 21-7

HR60

- Industrial relay with LED status indicator and mechanical actuator
- Socket width 27mm
- 2 or 4 changeover contacts
- lth rated current:
 - 2 contacts: 7A
 - 4 contacts: 5A
- LED and mechanical status indicator
- Mechanical test actuator with latch option
- AC or DC control voltage
- Sockets with screw or spring terminals
- Snap-on surge suppressor filters.



Page 21-8

HR70





















- Industrial relay with LED status indicator and mechanical actuator
- Socket width 38mm
- 8-pin and 11-pin industrial relay
- 2 or 3 changeover contacts
- lth rated current: 10A
- LED and mechanical state indicator
- Mechanical test actuator with latch option
- Versions with AC or DC control.



Page 21-8

HR80

- Power relays with Atex certificate
- In 30A
- 2 normally open or 2 changeover contacts
- Faston terminals
- Screw fixing.

Relays	Code	Contacts	Rated current	Control voltage	Sockets				
SLIM RELAYS		HRA101CE024	1 C/O	6A	24VAC/DC	Version with relay assembled on socket			
		HRA101CE024SⓈ	1 C/O	6A	24VAC/DC				
		HR101CE012	1 C/O	6A	12VAC/DC	 HR1XS024 - HR1XS024SⓈ HR1XS110 - HR1XS110SⓈ HR1XS230 - HR1XS230SⓈ HR1XS024 - HR1XS024SⓈ			
		HR101CE024	1 C/O	6A	24VAC/DC				
		HR101CE060	1 C/O	6A	110...125VAC/DCⓈ 220...240VAC/DCⓈ				
		HR201AS024	1 SSR	2A (AC)	24VDC				
		HR201DS024	1 SSR	4A (DC)	24VDC				
	MINIATURE RELAYS		HR301CD012	1 C/O	16AⓈ	12VDC	Max 10A  HR5XS21 Screw terminals. Contact terminals all on upper side.  HR5XS22 Screw terminals.  HR5XS21S Spring terminals.  HR5XS21P PIN terminals. For Printed Circuit Board.		
			HR301CD024	1 C/O	16AⓈ	24VDC			
HR301CD048			1 C/O	16AⓈ	48VDC				
HR301CA024			1 C/O	16AⓈ	24VAC				
HR301CA110			1 C/O	16AⓈ	110...120VAC				
HR301CA230			1 C/O	16AⓈ	230VAC				
HR302CD012			2 C/O	8A	12VDC				
HR302CD024			2 C/O	8A	24VDC				
HR302CD048			2 C/O	8A	48VDC				
HR302CA024			2 C/O	8A	24VAC				
HR302CA110			2 C/O	8A	110...120VAC				
HR302CA230			2 C/O	8A	230VAC				
MINIATURE RELAYS CLEAR ENCLASURE				HR401CD012	1 C/O	16AⓈ		12VDC	
				HR401CD024	1 C/O	16AⓈ		24VDC	
	HR402CD012	2 C/O		10A	12VDC				
	HR402CD024	2 C/O		10A	24VDC				
	MINIATURE RELAYS WITH LED STATE INDICATOR AND MECHANICAL ACTUATOR			HR501CD012	1 C/O	16AⓈ	12VDC		
				HR501CD024	1 C/O	16AⓈ	24VDC		
				HR501CD048	1 C/O	16AⓈ	48VDC		
				HR501CD110	1 C/O	16AⓈ	110VDC		
				HR501CA024	1 C/O	16AⓈ	24VAC		
				HR501CA110	1 C/O	16AⓈ	110...120VAC		
HR501CA230			1 C/O	16AⓈ	230VAC				
HR502CD012			2 C/O	8A	12VDC				
HR502CD024			2 C/O	8A	24VDC				
HR502CD048			2 C/O	8A	48VDC				
HR502CD110	2 C/O	8A	110VDC						
HR502CA012	2 C/O	8A	12VAC						
HR502CA024	2 C/O	8A	24VAC						
HR502CA110	2 C/O	8A	110...120VAC						
HR502CA230	2 C/O	8A	230VAC						
INDUSTRIAL RELAYS WITH LED INDICATOR AND MECHANICAL ACTUATOR		HR602CD012	2 C/O	7A	12VDC	 HR6XS21 Screw terminals. Contact terminals on upper side.  HR6XS22 Screw terminals.  HR6XS41S Spring terminals.  HR6XS41 Screw terminals. Contact terminals on upper side.  HR6XS42 Screw terminals.  HR6XS41S Spring terminals.			
		HR602CD024	2 C/O	7A	24VDC				
		HR602CD048	2 C/O	7A	48VDC				
		HR602CA012	2 C/O	7A	12VAC				
		HR602CA024	2 C/O	7A	24VAC				
		HR602CA110	2 C/O	7A	110...120VAC				
		HR602CA230	2 C/O	7A	230VAC				
		HR604CD012	4 C/O	5A	12VDC				
		HR604CD024	4 C/O	5A	24VDC				
		HR604CD048	4 C/O	5A	48VDC				
		HR604CA012	4 C/O	5A	12VAC				
		HR604CA024	4 C/O	5A	24VAC				
		HR604CA110	4 C/O	5A	110...120VAC				
		HR604CA230	4 C/O	5A	230VAC				
8-PIN AND 11-PIN INDUSTRIAL RELAYS WITH LED STATE INDICATOR AND MECHANICAL ACTUATOR		HR702CD024	2 C/O	10A	24VDC	8-pin  HR7XS1 Screw terminals. 11-pin  HR7XS2 Screw terminals.			
		HR702CD048	2 C/O	10A	48VDC				
		HR702CD110	2 C/O	10A	110VDC				
		HR702CA024	2 C/O	10A	24VAC				
		HR702CA110	2 C/O	10A	110...120VAC				
		HR702CA230	2 C/O	10A	230VAC				
		HR703CD024	3 C/O	10A	24VDC				
		HR703CD048	3 C/O	10A	48VDC				
		HR703CD110	3 C/O	10A	110VDC				
		HR703CA024	3 C/O	10A	24VAC				
HR703CA110	3 C/O	10A	110...120VAC						
HR703CA230	3 C/O	10A	230VAC						
POWER RELAYS WITH ATEX CERTIFICATE		HR8020A024	2 NO	30A	24VACⓈ				
		HR8020A230	2 NO	30A	240VACⓈ				
		HR802CA024	2 C/O	30A	24VACⓈ				
		HR802CA230	2 C/O	30A	240VACⓈ				

Code	Retaining clips	Code	Marker tags	Code	Parallel busbars	Code	Surge suppressor filters
	Included in the socket	HR1X30 		HR1X9020 (black) 	20 poles		
		HR1X3016 (strip with 16 tags) 		HR1X9120 (red) 			
HR3X88 Ⓞ 							
HR3X86 Ⓞ 							
HR5X88 Ⓞ 		HR5X30 Ⓞ 		HR5X9008 (black) ④ 	8 poles		
HR5X86 Ⓞ 				HR5X9002 Ⓞ 	2 poles	Resistor - Capacitor HR6X77024 6...24VAC/DC HR6X77230 110...230VAC/DC	
HR5X87 Ⓞ 						Diode + LED HR6X78024 6...24VDC	
HR6X88 Ⓞ 		HR6X30 		HR5X9002 Ⓞ 	2 poles		
HR6X87 							
HR7X87 							

Ⓞ Final S in code indicates spring terminals.
 ② Voltage dependent on selected relay socket; rated insulation voltage only for relay 60VDC.
 ③ Rated current if the relay is soldered directly onto the board; with socket the maximum current is 10A.
 ④ For sockets with screw terminals.
 ⑤ Only mounting on socket HR5XS21P.
 ⑥ Not suitable for HR5XS21P socket.
 ⑦ Bus jumper for A2 terminal; for spring terminals sockets only.
 ⑧ Not suitable for spring terminals sockets.
 ⑨ Other voltages available on request: 24, 120, 208, 220, 277VAC - 5, 6, 12, 24, 48, 110VDC.

Slim relays



HRA10...



HR10...



HR20...

Order code	Control voltage	Contacts	Rated current	Description	Qty per pkg
			[A]		no.

Slim electromechanical relays assembled on the socket.

HRA101CE024	24VAC/DC	1 C/O	6	Screw terminals	10
HRA101CE024S	24VAC/DC	1 C/O	6	Spring terminals	10

Slim electromechanical relays.

HR101CE012	12VDC	1 C/O	6	12VAC/DC control when on HR1XS024 or HR1XS024S socket	20
-------------------	-------	-------	---	---	----

HR101CE024	24VDC	1 C/O	6	24VAC/DC control when on HR1XS024 or HR1XS024S socket	20
-------------------	-------	-------	---	---	----

HR101CE060	60VDC	1 C/O	6	110...125VAC/DC control when on HR1XS110 or HR1XS110S socket. 220...240VAC/DC control when on HR1XS230 or HR1XS230S socket	20
-------------------	-------	-------	---	--	----

Slim SSR (solid state relay) relays.

HR201AS024	24VDC	1 SSR	2	Output 24...280VAC	20
HR201DS024	24VDC	1 SSR	4	Output 3...28VDC	20

General characteristics

Slim-type relays have a reduced width that permits considerable optimisation of space. All sockets are equipped with supply indicator LED and retain/release clips. The availability of electromechanical and solid-state (SSR) versions permits the installation of the most technically suitable solution in accordance with system requirements. The socket terminals can be screw or spring type.

The parallel busbars make for quick wiring.

Operational characteristics

- Rated insulation voltage: 250V
- Rated impulse withstand voltage: 4kV
- Relay control voltage: 12, 24, 60VDC
- Relay control voltage + socket: 12, 24, 110...125, 220...240VAC/DC
- Max controllable power in AC-1: 1500W
- Max controllable power in AC-15: 360VA.

Certifications and compliance

Certifications obtained: cURus, CSA, EAC, VDE for electromechanical relays HR10..., cURus, TÜV for SSR relay HR20....

Compliant with standards: IEC/EN/BS 61810-1 for electromechanical relays, IEC/EN/BS 62314 for SSR.

Sockets



HR1XS...



HR1XS...S

Order code	Control voltage	Terminals	Description	Qty per pkg
	AC/DC			no.

Sockets for relays.

HR1XS024	12...24V	Screw	Use with relay HR101CE012, HR101CE024 and HR20...	10
-----------------	----------	-------	---	----

HR1XS110	110...125V	Screw	Use with relay HR101CE060	10
-----------------	------------	-------	---------------------------	----

HR1XS230	220...240V	Screw	Use with relay HR101CE060	10
-----------------	------------	-------	---------------------------	----

HR1XS024S	12...24V	Spring	Use with relay HR101CE012, HR101CE024 and HR20...	10
------------------	----------	--------	---	----

HR1XS110S	110...125V	Spring	Use with relay HR101CE060	10
------------------	------------	--------	---------------------------	----

HR1XS230S	220...240V	Spring	Use with relay HR101CE060	10
------------------	------------	--------	---------------------------	----

General characteristics

HR1X... sockets are equipped with supply indicator LED and retain/release clips. The socket terminals can be screw or spring type. Parallel busbars can be fitted to the sockets, for quick wiring. These busbars plug in, on both the screw and spring sockets, leaving the cable entry terminals free.

Operational characteristics

- Rated insulation voltage: 250V
- Rated impulse withstand voltage: 4kV
- Relay control voltage: 12, 24, 60VDC
- Relay control voltage + socket: 12, 24, 110...125, 220...240VAC/DC
- Green indication LED
- Fitting on DIN rail
- Operating temperature: HR1XS024 -40...+70°C, HR1XS110 and HR1XS230 -40...+55°C.

Certifications and compliance

Certifications obtained: cURus, CSA, EAC, VDE for electromechanical relay HR10..., cURus, TÜV for SSR relay HR20....

Compliant with standards: IEC/EN/BS 61810-1 for electromechanical relays, IEC/EN/BS 62314 for SSR.

Accessories



HR1X30...



HR1X9020

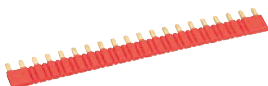

HR1X9120

Order code	Description	Qty per pkg
		no.
HR1X30	Marker tags	100
HR1X3016	Marker tags - strip with 16 tags	20
HR1X9020	20-pole parallel busbar - black	10
HR1X9120	20-pole parallel busbar - red	10

Miniature relays



HR30...

new

new

Order code	Control voltage	Contacts	Rated current	Description	Qty per pkg
			[A]		no.
Miniature relays.					
HR301CD012	12VDC	1 C/O	16	Fitting on socket HR5XS2... (max 10A)	20
HR301CD024	24VDC	1 C/O	16	Fitting on socket HR5XS2... (max 10A)	20
HR301CD048	48VDC	1 C/O	16	Fitting on socket HR5XS2... (max 10A)	20
HR301CA024	24VAC	1 C/O	16	Fitting on socket HR5XS2... (max 10A)	20
HR301CA110	110/120VAC	1 C/O	16	Fitting on socket HR5XS2... (max 10A)	20
HR301CA230	230VAC	1 C/O	16	Fitting on socket HR5XS2... (max 10A)	20
HR302CD012	12VDC	2 C/O	8	Fitting on socket HR5XS2...	20
HR302CD024	24VDC	2 C/O	8	Fitting on socket HR5XS2...	20
HR302CD048	48VDC	2 C/O	8	Fitting on socket HR5XS2...	20
HR302CA024	24VAC	2 C/O	8	Fitting on socket HR5XS2...	20
HR302CA110	110/120VAC	2 C/O	8	Fitting on socket HR5XS2...	20
HR302CA230	230VAC	2 C/O	8	Fitting on socket HR5XS2...	20

General characteristics

Miniature relays have compact dimensions but high functional performance. It's the ideal device for those looking for a cost-effective solution without compromising performance.

Operational characteristics

- Rated insulation voltage: 250V
- Rated impulse withstand voltage: 4kV
- Relay control voltage: 12, 24 and 48VDC - 24, 110/120 and 230VAC, 50/60Hz
- Max controllable power in AC-1 (1C/2C): 4000/2000W
- Max controllable power in AC-15 (1C/2C): 300/150VA
- Maximum current (1C/2C): 16A/8A.

Certifications and compliance

Certifications obtained: cURus, CSA, EAC, VDE (VDE except for HR301CA...).

Compliant with standards: IEC/EN/BS 61810-1.

Sockets



HR5XS21

HR5XS22



HR5XS21S



HR5XS21P

Order code	Description	Qty per pkg
		no.
Sockets for relays (supplied without retain/release clip). Terminal layout see page 21-10.		
HR5XS21	Screw terminals, contact terminals all on upper side	10
HR5XS22	Screw terminals. Fitting on DIN rail or with screws	10
HR5XS21S	Spring terminals. Fitting on DIN rail or with screws	10
HR5XS21P	PIN terminals for Printed Circuit Board	40

General characteristics

HR5X... series sockets can have screw terminals or spring terminals for quick wiring. A socket with pins for PCB is also available. Screw terminals are available in 2 versions: with contact terminals separated from the coil terminals or with NC contact terminals near the coil terminals. Surge suppressor filters, parallel busbars and tags for wiring can be snap-fitted to the sockets.

Operational characteristics

- Rated insulation voltage: 250V
- Rated impulse withstand voltage: 4kV
- Maximum current: 10A
- Terminal layout see page 21-10
- Operating temperature: -40...+70°C.

Certifications and compliance

Certifications obtained: cURus, CSA, EAC (PCB socket is cURus only).

Compliant with standards: IEC/EN/BS 61810-1.

Accessories



HR3X88



HR3X86



HR5X30



HR6X78024



HR5X9008



HR5X9002

new

Order code	Description	Qty per pkg
		no.
HR3X88	Retain/release clip. Not suitable for HR5XS21P socket	20
HR3X86	Retaining clip. Only mounting on socket HR5XS21P	10
HR5X30	Marker tags	100
HR6X78024	Plug-in surge suppressor filters. 6...24VDC with LED	10
HR6X77024	Plug-in surge suppressor filters. 6...24VAC/DC (RC)	10
HR6X77230	Plug-in surge suppressor filters. 110...230VAC/DC (RC)	10
HR5X9008	8-pole parallel busbar - black - for sockets with screw terminals	10
HR5X9002	Bus jumper for A2 terminals; for spring terminal sockets only	10

HR5XS21S socket with Push-in technology

Push-in wiring without using a screwdriver for cables with end lugs. They guarantee fast wiring and clamping force maintained over time even in the presence of vibrations and / or shocks. To connect cables without end lug and for cables removal, a screwdriver needs to push the handy buttons.

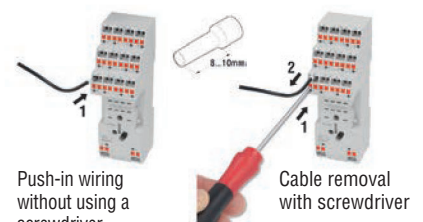

Push-in wiring without using a screwdriver

Cable removal with screwdriver

Miniature relays clear enclosure



HR40...

Order code	Control voltage	Contacts	Rated current	Description	Qty per pkg
			[A]		no.

Miniature relays clear enclosure.

new

HR401CD012	12VDC	1 C/O	16	Mounting on HR5XS2... socket (max 10A)	50
HR401CD024	24VDC	1 C/O	16		50
HR402CD012	12VDC	2 C/O	10	Mounting on HR5XS2... socket	50
HR402CD024	24VDC	2 C/O	10		50

Miniature relays with LED state indicator and mechanical actuator



HR50...

Order code	Control voltage	Contacts	Rated current	Description	Qty per pkg
			[A]		no.

Miniature relays with LED state indicator and mechanical actuator.

new

HR501CD012	12VDC	1 C/O	16	Mounting on HR5XS2... socket (max 10A)	10
HR501CD024	24VDC	1 C/O	16		10
HR501CD048	48VDC	1 C/O	16		10
HR501CD110	110VDC	1 C/O	16		10
HR501CA024	24VAC	1 C/O	16		10
HR501CA110	110/120VAC	1 C/O	16		10
HR501CA230	230VAC	1 C/O	16		10
HR502CD012	12VDC	2 C/O	8	Mounting on HR5XS2... socket	10
HR502CD024	24VDC	2 C/O	8		10
HR502CD048	48VDC	2 C/O	8		10
HR502CD0110	110VDC	2 C/O	8		10
HR502CA012	12VAC	2 C/O	8		10
HR502CA024	24VAC	2 C/O	8		10
HR502CA110	110/120VAC	2 C/O	8		10
HR502CA230	230VAC	2 C/O	8		10

Sockets



HR5XS21

HR5XS22



HR5XS21S



HR5XS21P

Order code	Description	Qty per pkg
		no.

Sockets for relays (supplied without retain/release clip). Terminal layout see page 21-10.

HR5XS21	Screw terminals, contact terminals all on upper side. Fitting on DIN rail or with screws	10
HR5XS22	Screw terminals. Fitting on DIN rail or with screws	10
HR5XS21S	Spring terminals. Fitting on DIN rail or with screws	10
HR5XS21P	PIN terminals for Printed Circuit Board	40

Accessories



HR5X86

HR5X87



HR5X88



HR5X30



HR6X78024

HR6X77230



HR5X9008



HR5X9002

new

Order code	Description	Qty per pkg
		no.
HR5X86	Metal retaining clip. Only mounting on HR5XS21P socket	10
HR5X87	Metal retaining clip. Not suitable for HR5XS21P socket	20
HR5X88	Plastic retaining clip. Not suitable for HR5XS21P socket	10
HR5X30	Marker tags	100
HR6X78024	Plug-in surge suppressor filters. 6...24VDC with LED	10
HR6X77230	Plug-in surge suppressor filters. 6...24VAC/DC (RC)	10
HR6X77230	Plug-in surge suppressor filters. 110...230VAC/DC (RC)	10
HR5X9008	8-pole parallel busbar - black	10
HR5X9002	Bus jumper for A2 terminals; for spring terminal sockets only	10

General characteristics

HR40... and HR50... miniature relays have reduced dimensions and, in addition to the high electrical performance. HR40... has a clear enclosure that allow contacts visibility for wear and tear check. HR50... is equipped with the following functions: LED to indicate voltage on the coil, mechanical contact state indicator and mechanical test actuator. The mechanical actuator is particularly useful for performing functional tests; it can also keep the relay closed continuously.

Operational characteristics

- Rated insulation voltage: 250V (400V with pollution degree 2)
- Relay control voltage:
 - HR40... and HR50...: 12 and 24VDC (48VDC for HR50... only)
 - HR50...: 12, 24, 110/120 and 230VAC 50/60Hz
- Max AC-1 controllable power (1C/2C):
 - HR40...: 3840/2500W
 - HR50...: 4000/2000W
- Max AC-15 controllable power: 150VA
- Maximum current (1C/2C):
 - HR40...: 16/10A
 - HR50...: 16A/8A.

Certifications and compliance

Certifications obtained: HR401C... cURus; HR402C... cURus, TÜV; HR501C... and HR502C... cURus, CSA, EAC, VDE. Note: HR502CA012 no certification. Compliant with standards: IEC/EN/BS 61810-1.

General characteristics

HR5X... series sockets can have screw terminals or spring terminals for quick wiring. A socket with pins for PCB is also available. Screw terminals are available in 2 versions: with contact terminals separated from the coil terminals or with NC contact terminals near the coil terminals. Surge suppressor filters, parallel busbars and tags for wiring can be snap-fitted to the sockets intended for DIN rail mounting.

Operational characteristics

- Rated insulation voltage: 250V
- Rated impulse withstand voltage: 4kV
- Maximum current: 10A
- Terminal layout see page 21-10
- Operating temperature: -40...+70°C.

Certifications and compliance

Certifications obtained: cURus, CSA, EAC (PCB socket is cURus only). Compliant with standards: IEC/EN/BS 61810-1.

HR5XS21S socket with Push-in technology

Push-in wiring without using a screwdriver for cables with end lugs. They guarantee fast wiring and clamping force maintained over time even in the presence of vibrations and / or shocks. To connect cables without end lug and for cables removal, a screwdriver needs to push the handy buttons.

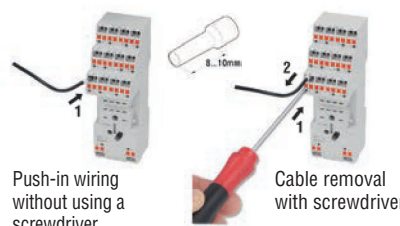

Push-in wiring without using a screwdriver

Cable removal with screwdriver

Industrial relays with LED state indicator and mechanical actuator



HR60...

Order code	Control voltage	Contacts	Rated current	Description	Qty per pkg no.
Industrial relays with LED state indicator and mechanical actuator.					
HR602CD012	12VDC	2 C/O	7	Fitting on socket HR6XS2...	10
HR602CD024	24VDC	2 C/O	7	Fitting on socket HR6XS2...	10
HR602CD048	48VDC	2 C/O	7	Fitting on socket HR6XS2...	10
HR602CA012	12VAC	2 C/O	7	Fitting on socket HR6XS2...	10
HR602CA024	24VAC	2 C/O	7	Fitting on socket HR6XS2...	10
HR602CA110	110/120VAC	2 C/O	7	Fitting on socket HR6XS2...	10
HR602CA230	230VAC	2 C/O	7	Fitting on socket HR6XS2...	10
HR604CD012	12VDC	4 C/O	5	Fitting on socket HR6XS4...	10
HR604CD024	24VDC	4 C/O	5	Fitting on socket HR6XS4...	10
HR604CD048	48VDC	4 C/O	5	Fitting on socket HR6XS4...	10
HR604CA012	12VAC	4 C/O	5	Fitting on socket HR6XS4...	10
HR604CA024	24VAC	4 C/O	5	Fitting on socket HR6XS4...	10
HR604CA110	110/120VAC	4 C/O	5	Fitting on socket HR6XS4...	10
HR604CA230	230VAC	4 C/O	5	Fitting on socket HR6XS4...	10

General characteristics

HR60... type industrial relays are available in 2/4-changeover-contact versions. They are equipped with LEDs that indicate control voltage, a mechanical contact state indicator and a mechanical actuator. The actuator is particularly useful for performing functional tests; it can also keep the relay closed continuously.

Operational characteristics

- Rated insulation voltage: 250V
- Rated impulse withstand voltage: 4kV
- Relay control voltage: 12, 24 or 48VDC - 12, 24, 110/120 and 230VAC, 50/60Hz
- Max controllable current in AC-1 (2C/4C): 7/5A
- Maximum current (2C/4C): 7A/5A.

Certifications and compliance

Certifications obtained: cURus, CSA, EAC, VDE.
Compliant with standards: IEC/EN/BS 61810-1.

Sockets



HR6XS21 HR6XS41

new



HR6XS42 HR6XS41S

new

Order code	Description	Qty per pkg no.
Sockets for relays (supplied without retain/release clip) for fitting on DIN rail or with screws. Terminal layout see page 21-10 and 11. For relays with 2 changeover contacts.		
HR6XS21	Screw terminals, contact terminals all on upper side	10
HR6XS22	Screw terminals	10
HR6XS41S	Spring terminals with Push-in technology	10
For relays with 4 changeover contacts.		
HR6XS41	Screw terminals, contact terminals all on upper side	10
HR6XS42	Screw terminals	10
HR6XS41S	Spring terminals with Push-in technology	10

General characteristics

HR6X... series sockets have screw terminals and are supplied in two versions for relays with 2 or 4 contacts. Surge suppressor filters and tags for wiring can be plugged in to the sockets. They can be fixed on DIN rail or with screws.

Operational characteristics

- Rated insulation voltage: 250V
- Rated impulse withstand voltage: 4kV
- Maximum current: 10A
- Terminal layout see page 21-10 and 11
- Operating temperature: -40...+70°C.

Certifications and compliance

Certifications obtained: cURus, CSA, EAC.
Compliant with standards: IEC/EN/BS 61810-1.

Accessories



HR6X88

HR6X87

HR5X30

HR5X9002

HR6X78024

new

Order code	Description	Qty per pkg no.
HR6X87	Metal retaining clip	20
HR6X88	Plastic retain/release clip	20
HR6X30	Marker tag for sockets with screw terminals	100
HR5X30	Marker tag for sockets with spring terminals	100
HR6X78024	Plug-in surge suppressor filters. 6...24VDC with LED	10
HR6X77024	Plug-in surge suppressor filters. 6...24VAC/DC (RC)	10
HR6X77230	Plug-in surge suppressor filters. 110...230VAC/DC (RC)	10
HR5X9002	Bus jumper for A2 terminals; for spring terminal sockets only	10

HR6XS41S socket with Push-in technology

Push-in wiring without using a screwdriver for cables with end lugs. They guarantee fast wiring and clamping force maintained over time even in the presence of vibrations and / or shocks. To connect cables without end lug and for cables removal, a screwdriver needs to push the handy buttons.

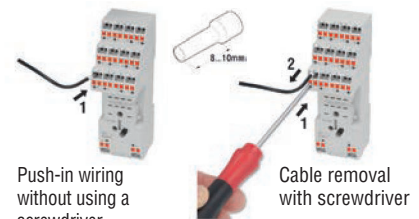

Push-in wiring without using a screwdriver

Cable removal with screwdriver

❶ Not suitable for sockets with spring terminals.

8-pin and 11-pin industrial relays with LED state indicator and mechanical actuator



HR70...

Order code	Control voltage	Contacts	Rated current	Description	Qty per pkg
			[A]		no.

Industrial relays with LED state indicator and mechanical actuator. 8-pin type.

HR702CD024	24VDC	2 C/O	10	Fitting on socket HR7XS1	10
HR702CD048	48VDC	2 C/O	10	Fitting on socket HR7XS1	10
HR702CD110	110VDC	2 C/O	10	Fitting on socket HR7XS1	10
HR702CA024	24VAC	2 C/O	10	Fitting on socket HR7XS1	10
HR702CA110	110/120VAC	2 C/O	10	Fitting on socket HR7XS1	10
HR702CA230	230VAC	2 C/O	10	Fitting on socket HR7XS1	10

Industrial relays with LED state indicator and mechanical actuator. 11-pin type.

HR703CD024	24VDC	3 C/O	10	Fitting on socket HR7XS2	10
HR703CD048	48VDC	3 C/O	10	Fitting on socket HR7XS2	10
HR703CD110	110VDC	3 C/O	10	Fitting on socket HR7XS2	10
HR703CA024	24VAC	3 C/O	10	Fitting on socket HR7XS2	10
HR703CA110	110/120VAC	3 C/O	10	Fitting on socket HR7XS2	10
HR703CA230	230VAC	3 C/O	10	Fitting on socket HR7XS2	10

General characteristics

HR70... type industrial relays are available in 2 or 3 changeover versions. They are equipped with LEDs that indicate control voltage, mechanical contact state indicator and mechanical actuator. The actuator is particularly useful for performing functional tests; it can also keep the relay closed continuously. HR70... has high electrical endurance performance and lends itself to the most heavy-duty applications.

Operational characteristics

- Rated insulation voltage: 250V
- Rated impulse withstand voltage: 4kV
- Relay control voltage: 24 and 48VDC- 24, 110/120 and 230VAC, 50/60Hz
- Maximum current: 10A.

Certifications and compliance

Certifications obtained: cURus, CSA, EAC. Compliant with standards: IEC/EN/BS 61810-1.

Sockets



HR7XS1

HR7XS2

Order code	Description	Qty per pkg
		no.

Sockets for relays (supplied without retaining clip), for fitting on DIN rail or with screws. Terminal layout see page 21-11.

HR7XS1	8-pin for HR702C... Screw terminals	10
HR7XS2	11-pin for HR703C... Screw terminals	10

General characteristics

HR7X... series sockets have screw terminals and are supplied in two versions for relays with 2 or 3 contacts (8-pin - 11-pin). They can be fixed on DIN rail or with screws.

Operational characteristics

- Rated insulation voltage: 250V
- Rated impulse withstand voltage: 4kV
- Maximum current: 10A
- Operating temperature: -40...+70°C.

Certifications and compliance

Certifications obtained: cURus, CSA, EAC. Compliant with standards: IEC/EN/BS 61810-1.

Accessories



HR7X87

Order code	Description	Qty per pkg
		no.

HR7X87	Metal retaining clip	20
---------------	----------------------	----

Power relays with Atex certificate



HR80...

new

Order code	Control voltage ^②	Contacts	Rated current	Characteristics	Qty per pkg
			[A]		no.

HR8020A024	24VAC	2 NO	30	Faston terminals. Screw fixing	10
HR8020A230	240VAC	2 NO	30	Faston terminals. Screw fixing	10
HR802CA024	24VAC	2 C/O	30 ^①	Faston terminals. Screw fixing	10
HR802CA230	240VAC	2 C/O	30 ^①	Faston terminals. Screw fixing	10

① 3A for NC contact.

② Other voltages available on request: 24, 120, 208, 220, 277VAC - 5, 6, 12, 24, 48, 110VDC.

General characteristics

The HR80... power relays, thanks to the Atex certification, are particularly suitable for refrigeration systems that use propane gas. The compact structure and the front Faston terminals make them easy to install even in small spaces and speed up wiring.

Operational characteristics

- Rated insulation voltage: 250V (277V for UL)
- Rated impulse withstand voltage:
 - 4kV between contacts and coil
 - 1.5kV between open contacts
 - 2kV between poles
- Max current 30A for NO contacts; 3A for NC contacts
- Faston terminals 6.3x0.8mm.

Certifications and compliance

Certifications obtained: cURus, Atex. Compliant with standards: IEC/EN/BS 61810-1.

HR10... - HR10... - HR20 with socket HR1XS...

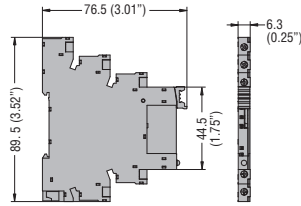

HR30... - HR40... - HR50... with socket HR5XS21

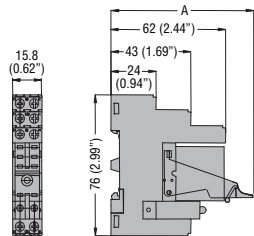

A: 64mm (2.52") with HR3X88
75mm (2.95") with XR5X88

HR30... - HR40... - HR50... with socket HR5XS21S

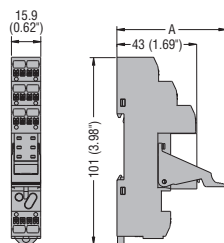

A: 60mm (2.36") with HR3X88
70mm (2.75") with XR5X88

HR30... - HR40... - HR50... with socket HR5XS22

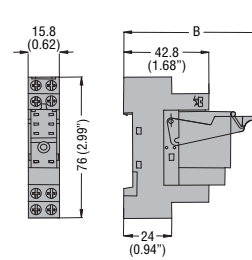

B: 57.5mm (2.26") with HR3X88
68mm (2.68") with XR5X88

HR5XS21P

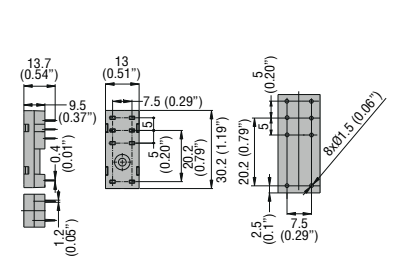

HR60... with socket HR6XS21 - HR6XS41

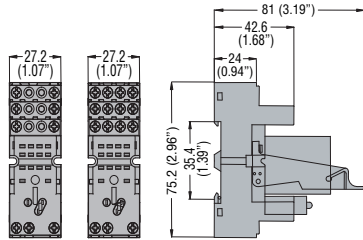

HR602C... - HR604C... with socket HR6XS41S

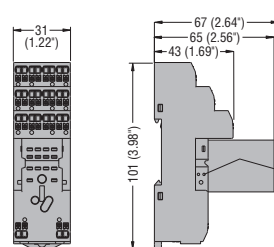

HR60... with socket HR6XS22 - HR6XS42

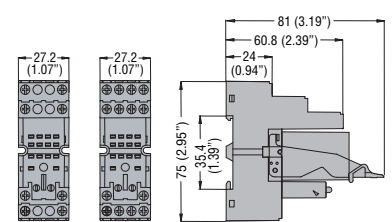

HR7XS1

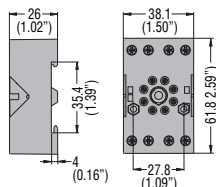

HR7XS2

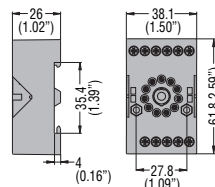

HR702C... - HX703C...

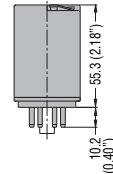

HR8020... - HX802C...

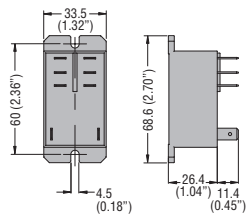

HR10 - HR20

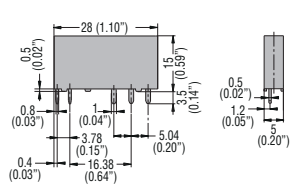

PCB layout

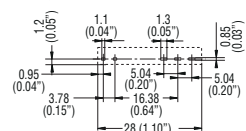

Connections



HR30

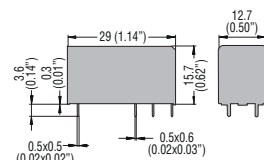

PCB layout

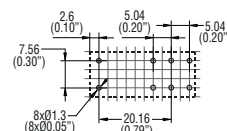

Connections

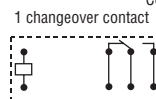

HR40 - HR50

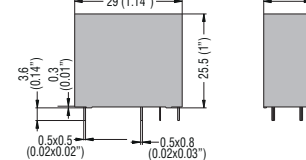

PCB layout

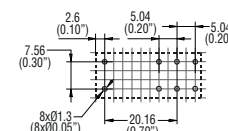

Connections



HR101C..., HRA101C...

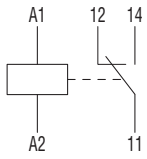

HR201A...

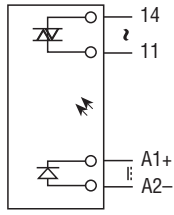

HR201D...

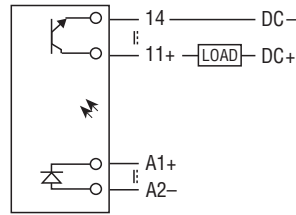

HR1XS...

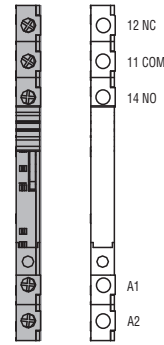

HR301C...

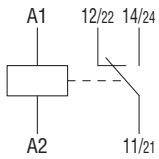

HR302C...

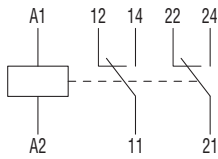

HR5XS21

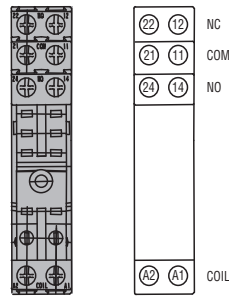

HR5XS21S

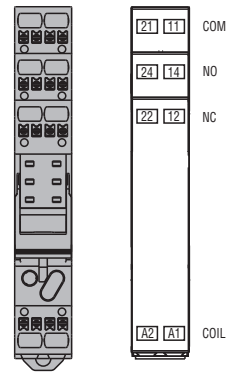

HR5XS22

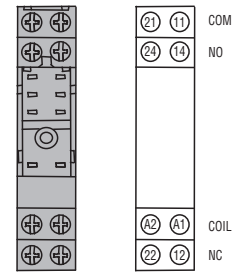

HR401C... - HR501C...

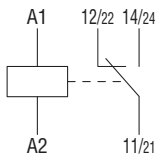

HR402C... - HR502C...

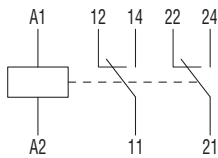

HR602C...

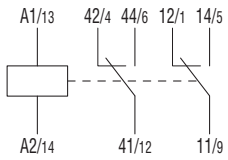

HR6XS21

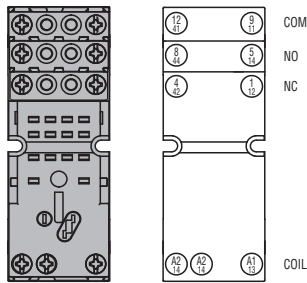

HR6XS41S

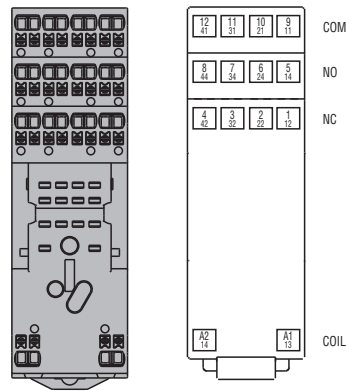

HR6XS22

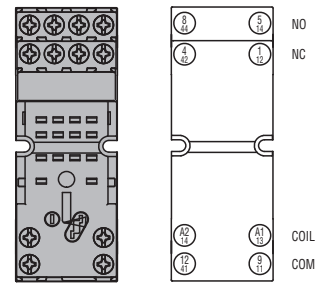

HR604C...

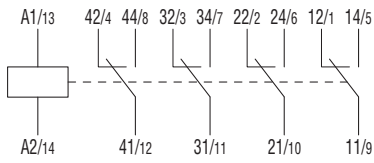

HR6XS41

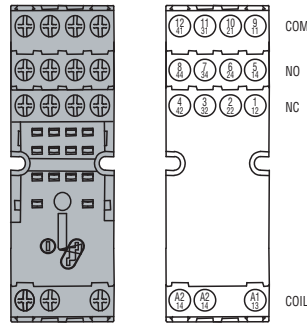

HR6XS41S

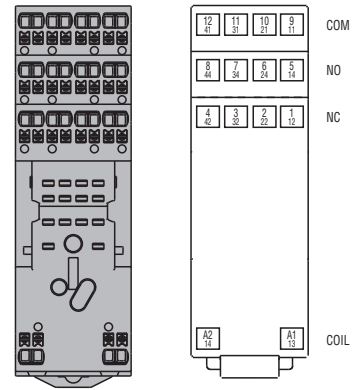

HR6XS42

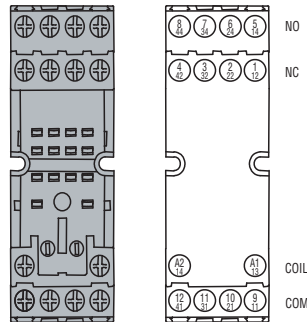

HR702C...

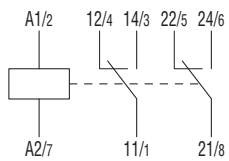

HR7XS1

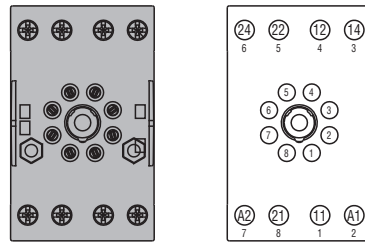

HR703C...

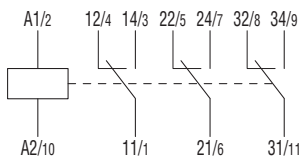

HR7XS2

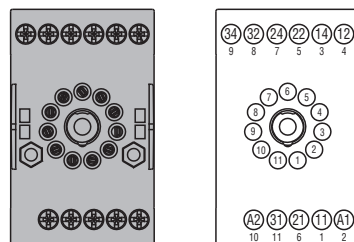

HR8020...

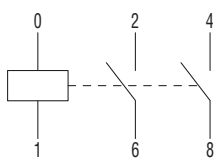

HR802C...

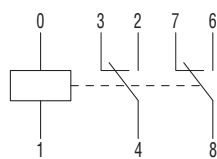

21 General purpose relays

Technical characteristics

Type		HRA10.. HR10...	HR20 1AS024	HR201DS024	HR301C...	HR302C...	HR401C...	HR402C...	
CHARACTERISTICS OF THE CONTACTS									
Contact configuration		1 C/O	1 static	1 static	1 C/O	2 C/O	1 C/O	2 C/O	
Rated insulation voltage U_i	V	250	2500 (in/out)	2500 (in/out)	250	250	250	250	
Rated impulse withstand voltage U_{imp}	kV	4	–	–	6	6	4	5	
Conventional free air thermal current I_{th}	A	6	2	4	16 ^②	8	16 ^②	10	
Maximum instantaneous current	A	20 (500ms)	80 (10ms)	48 (10ms)	60 ^①	20 ^①	60	26	
Rated operating voltage AC1	VA	1500	④	⑤	4000	2000	4000	2500	
Rated operating voltage AC15 (230VAC)	VA	360	④	⑤	300 ^①	150 ^①	500	400	
Single-phase motor control (230VAC)	kW	0.186	④	⑤	0.4	0.2	0.37	0.3	
Rated operating voltage DC1: 30/110/220V	A	6 / 0.2 / 0.12	④	⑤	12 / 0.3 / 0.1	8 / 0.3 / 0.1	10 / 0.3 / 0.12	8 / 0.3 / 0.12	
Minimum switching load	V / mA	5 / 100	24 / 0.1	3 / 0.02	5 / 100		5 / 100		
Contact impedance	mΩ	100	–	–	100		100		
Contact material		Ag/Ni	–	–	Ag/SnO ₂		Ag/SnO ₂		
Max socket terminal tightening torque	Nm	0.5			0.6		0.6		
Socket screw tightening tool (cross / flat blade)		Phillips 0 / 3.5mm			Phillips 1 / 4.5mm ^③		Phillips 1 / 4.5mm ^③		
Wire section on sockets with screw terminals (min...max)	mm ²	0.5...1.5 (0.75...2.5)			0.5...2.5		0.5...2.5		
	AWG	20...16 (20...14)			20...14		20...14		
OPERATING TIMES									
Closing	ms	≤8	10	0.3	< 10		< 15		
Opening	ms	≤4	10	0.3	< 5		< 5		
ENDURANCE									
Mechanical	Cycles	10,000,000	Theoretically infinite		10,000,000		10,000,000		
Electrical with load AC1	Cycles	30,000 ^①	Theoretically infinite		50,000 ^①		100,000 ^①		
COIL CHARACTERISTICS									
Average coil consumption AC (50/60Hz) at 20°C	VA	0.2	–	–	0.9		–	–	
Average coil consumption DC at 20°C	W	0.2	–	–	0.45		0.7	0.5	
Operating range	closing (% U_n)	≥75	80...120	80...120	70...110AC / 75...110DC		75...110	75...110	
	opening (% U_n)	≥5			20...55AC / 10...30DC		10...30	10...30	
Maximum cycle frequency	cycles/h	10,000	>100,000	>100,000	3,600		3,600	3,600	
AMBIENT CONDITIONS									
Operating temperature	°C	-40...+70	-30...+80		-40...+85		-40...+85		
Storage temperature	°C	-40...+80	-30...+100		-40...+85		-40...+85		
Fitting position		Any							
OTHER CHARACTERISTICS									
Indicator LED		Yes (on the socket)			No		No		
Mechanical contact position indicator		No			No		No		
Mechanical test actuator		No			No		No		
Socket fixing		On 35mm DIN rail			On 35mm DIN rail and with screws				

- ① NO contact.
- ② Maximum socket current of 10A.
- ③ 2.5mm flat blade for versions with spring terminals.
- ④ 2A output 24...280VAC.
- ⑤ 4A output 3...28VDC.

21 General purpose relays

Technical characteristics

	HR501C...	HR502C...	HR602C...	HR604C...	HR702C...	HR703C...	HR8020...	HR802C...
	1 C/O	2 C/O	2 C/O	4 C/O	2 C/O	3 C/O	2 NO	2 C/O
	250		500		250		250	
	6		4		6		4	
	16 ⓪	8	7	5	10	10	30	30 NO (3 NC)
	20 ⓪	10 ⓪	-	-	-	-	-	-
	4000	2000	1750	1250	2500	2500	-	-
	150 ⓪	150 ⓪	150 ⓪	150 ⓪	500	500	-	-
	0.1	-	0.37	0.37	1.2	1.2	2.2	2.2
	12 / 0.3 / 0.1	8 / 0.3 / 0.1	12 / 0.3 / 0.1	8 / 0.3 / 0.1	10 / - / -	10 / - / -	-	-
	5 / 100		5 / 100		5 / 100		-	-
	100		100		100		50	
	Ag/Ni		Ag/Ni		Ag/Ni		Ag/SnO ₂	
	0.6		0.6		0.6		-	
	Phillips 1 / 4.5mm ⓪		Phillips 1 / 4.5mm		Phillips 1 / 4.5mm		-	
	0.5...2.5		0.5...2.5		0.5...2.5		-	
	20...14		20...14		20...14		-	
	< 15		< 25		< 30		25	
	< 15		< 25		< 30		25	
	10,000,000		20,000,000		5,000,000		5,000,000	
	30,000 ⓪	50,000 ⓪	100,000		100,000		100,000	
	1		1.7		3		4	
	0.4		1.1		1.5		1	
	70...110AC / 75...110DC		70...110AC / 75...110DC		70...110AC / 75...110DC		80...110	
	20...55AC / 10...30DC		20...55AC / 10...30DC		20...55AC / 10...30DC		20...55	
	3,600		3,600		3,600		360	
	-40...+70		-40...+70		-40...+55		-40...+85	
	-40...+85		-40...+80		-40...+70		-40...+85	
	Any							
	Yes		Yes		Yes		No	
	Yes		Yes		Yes		No	
	Yes		Yes		Yes		No	
	On 35mm DIN rail and with screws		On 35mm DIN rail and with screws		On 35mm DIN rail and with screws		Screw fixing	

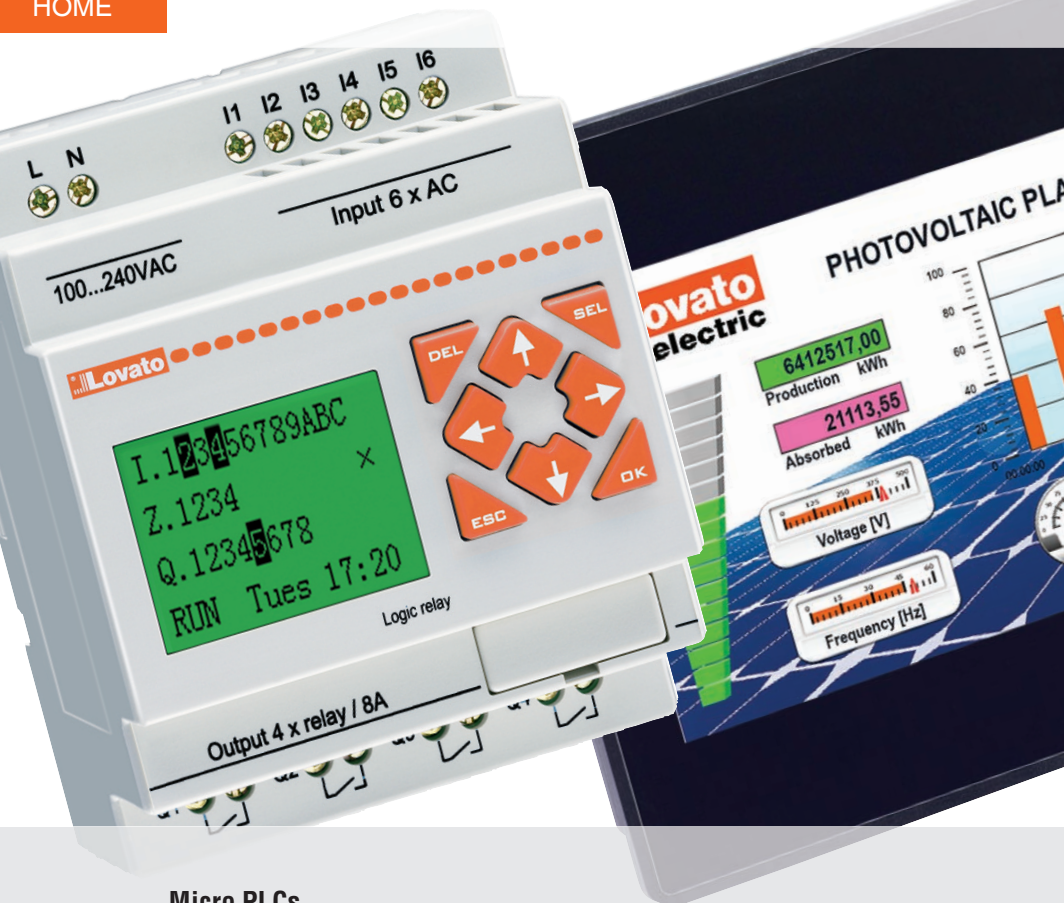

- 10, 12 and 20 Input-Output base modules
- Expansion modules with 4 digital Inputs and 4 digital Outputs
- Expansion modules with analog Inputs-Outputs
- RS485 Modbus-RTU slave communication module
- USB or RS232 cable for connection to PC or operator panel
- Program backup memory connection
- On-board programming languages: Italian, English, Spanish, French, German, Portuguese, Chinese, Polish, Russian, Turkish.
- Software programming languages: Italian, English and Spanish
- HMI with graphic touchscreen display, 64k colors, format 4.3", 7" and 10.1".

	SEC. - PAGE
Micro PLCs	
Base modules	22 - 4
Expansion and communication modules.....	22 - 4
Accessories	22 - 5
Kit	22 - 5
HMI	22 - 7
Dimensions	22 - 8
Wiring diagrams	22 - 9
Technical characteristics	22 - 10





Page 22-4

MICRO PLCs

- 10 Inputs/Outputs (LRD10...)
- 12 Inputs/Outputs (LRD12...)
- 20 Inputs/Outputs (LRD20...)
- 12VDC, 24VDC, 24VAC or 100...240VAC power supply
- Relay or transistor outputs.



Page 22-4

EXPANSION AND COMMUNICATION MODULES

- 4 digital inputs / 4 digital outputs
- Analog inputs, 0...10V or 0/4...20mA
- Analog outputs, 0...10V or 0/4...20mA
- Relay or transistor outputs
- PT100 temperature sensor inputs
- Modbus-RTU protocol slave communication unit
- 24VDC, 24VAC or 100...240VAC power supply.

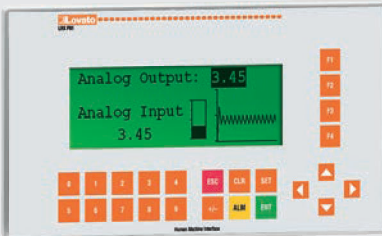

Page 22-5

ACCESSORIES

- Program backup memory
- Programming and supervision software
- Power supply unit
- HMI operator panel with graphic LCD.



Page 22-5

STARTER AND TRAINING KITS

- Complete kit to begin using micro PLCs, each equipped with LRD micro PLC, programming and supervision software and USB connecting cable
- Training kits complete with micro PLC and Inputs/Outputs simulation board.



Page 22-7

HMI

- TFT graphic display with touchscreen, 64k colors
- Available in formats 4.3", 7" and 10.1"
- Programming software
- IP66, Type 2 and 4X.

MICRO PLC - EXCEPTIONAL PERFORMANCE!



- **SYSTEM CONTROL AND SUPERVISION**
 - Contact status viewing in simple pages on display
 - Possibility to add the micro PLC to data networks. By using **Synergy** supervision and energy management software, a multiclient structure can also be managed through Web interface.
- **QUICK CONTROL BOARD INSTALLATION**
 - Fewer number of components
 - Less wiring with minor number of connections.
- **REPETITIVENESS**
 - Less errors during panel assembly
 - Considerable time saving.
- **FLEXIBILITY**
 - Quick correction of abnormal conditions at final testing
 - Fast changes on control boards.

● **FUNCTION BLOCKS AND MEMORY**

Timer (T) (delay on/off, recycle, pulsing, ...)	31
Real Time Clock (RTC) (daily, weekly, monthly and yearly mode)	31
Counter (C)	31
Analog comparator (G)	31
User's pages (H) - 16 characters - 4 lines	31
Auxiliary relays - Markers (M + N memory types)	63 + 63
Arithmetic operation: addition/subtraction and multiplication/division	31 + 31
Data register (DR)	240
Possibility to save in the internal memory:	
- Auxiliary relays	
- Counter values	
- Data registers.	

● **PROGRAM SIZE**

Language	
LADDER (contact scheme)	300 lines
FBD (function blocks)	260 blocks

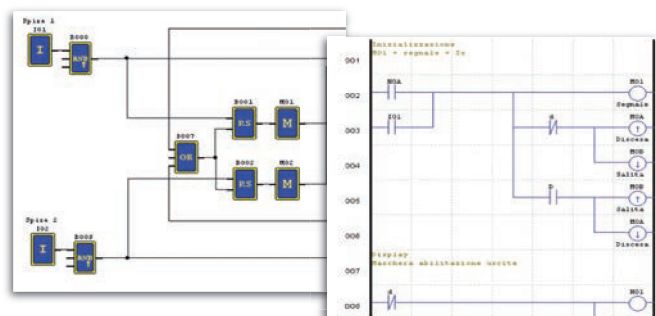

FUNCTIONS

● **PWM OUTPUT**

Pulse train generation with programmable pulse time and frequency

$$V_{out} = 24VDC \times \frac{T_{on}}{T}$$

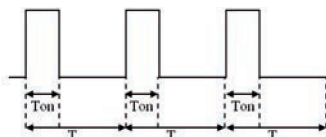

● **MULTIPLEXER**

Selection of 1 of 4 values according to the combination of two digital signals

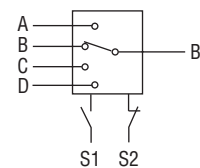

● **HIGH SPEED INPUT**

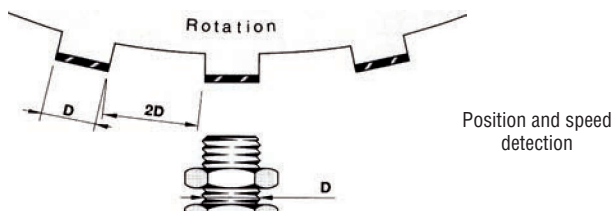

● **SHIFT FUNCTION** - activation of pulsed outputs in sequence

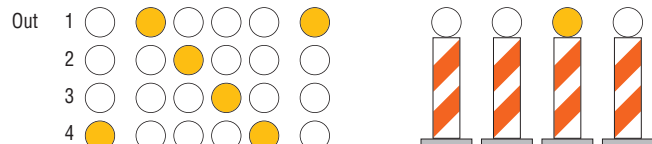

● **PID**

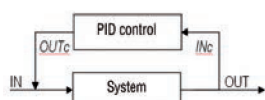

IN: heating switch on and required temperature setting
 OUT: current room temperature
 INc: measured room temperature in an exact spot
 OUTc: temperature adjusting and controlling.

● **BOOLEAN LOGIC BLOCKS**

Output activation based on a series of digital signals

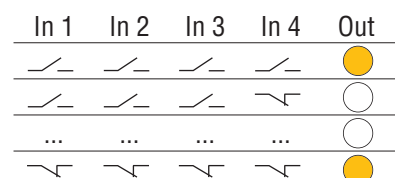

HMI OPERATOR PANEL LRXP01

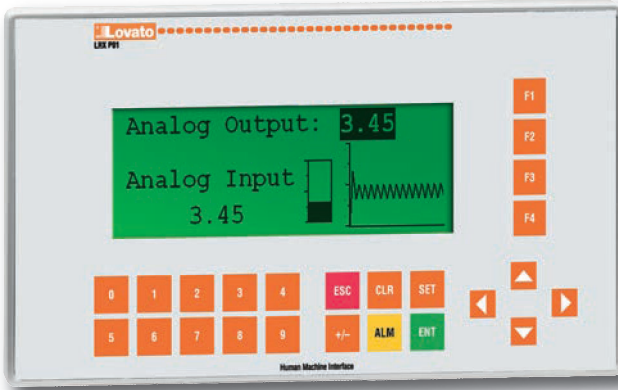

HMI INTERFACE

LRXP01 is a HMI operator panel, used with many types of PLCs or other intelligent controllers equipped with communication port with Modbus-RTU protocol.

By using the HMI, the values of both PLC inner registers and relay status can be monitored or modified with the keys of the frontal keyboard. This enables the functioning of machinery and equipment to be simple and direct.

The LRXSWP01 editor software permits to make dedicated screens by taking advantage of the graphic display to view bitmaps, bar graphs and trend lines.

BACKLIGHT 192x64 PIXEL GRAPHIC LCD

<p>Read numerical values</p> <p>Static text</p>	<p>Dynamic text</p> <p>Read status (bits)</p>	<p>Commands</p> <p>Display bar graphs and trend lines</p>	<p>Write numerical values</p>
<p>Images</p>			

COMMUNICATION MODES

LRXP01 supports Modbus-RTU protocol and can be connected to devices via the integrated RS232 and RS485 communication ports.

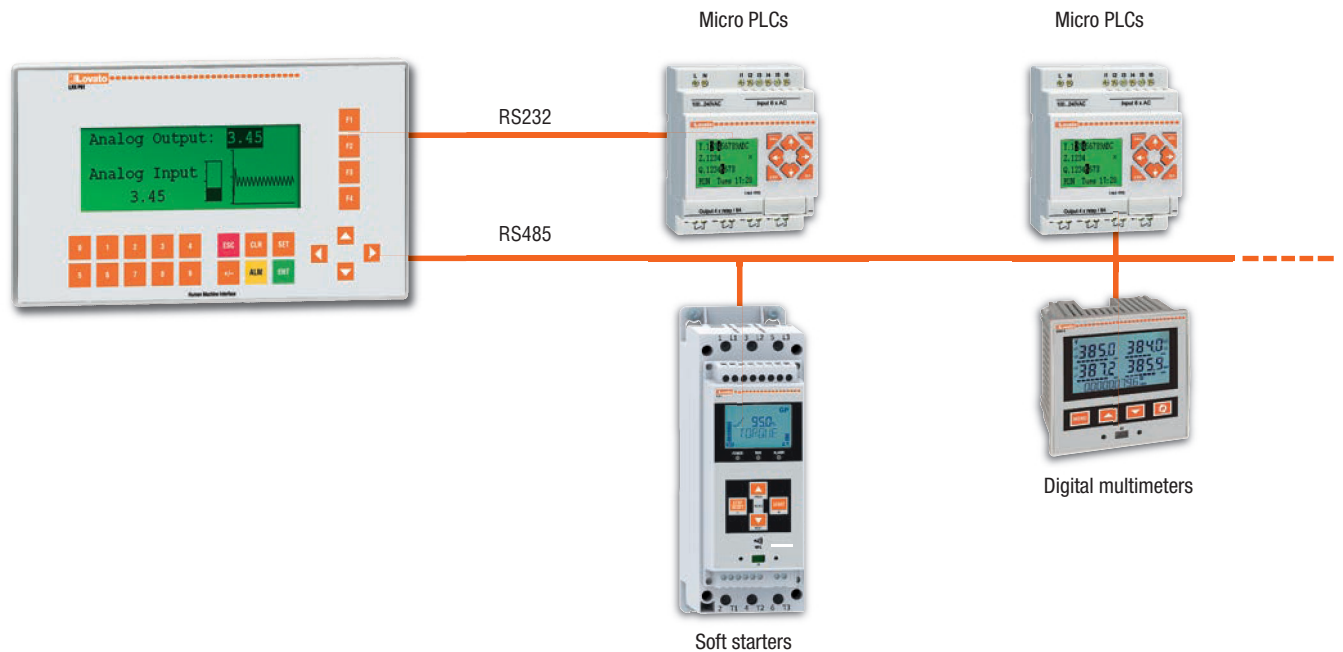

Base modules



LRD10...
LRD12...

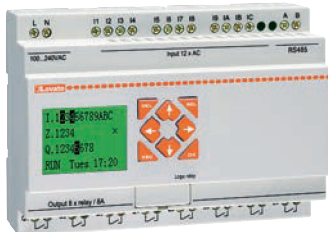

LRD20RD024P1

Order code	Auxiliary supply voltage	Inputs/Outputs	Qty per pkg	Wt
			n°	[kg]
Base modules.				
LRD12RD024	24VDC	8/4 relay	1	0.241
LRD12TD024	24VDC	8/4 transistor	1	0.220
LRD20RD024	24VDC	12/8 relay	1	0.360
LRD12RA024	24VAC	8/4 relay	1	0.250
LRD20RA024	24VAC	12/8 relay	1	0.368
LRD10RA240	100...240VAC	6/4 relay	1	0.242
LRD20RA240	100...240VAC	12/8 relay	1	0.367
LRD20RD012	12VDC	12/8 relay	1	0.360
Base modules with RS485 onboard.				
LRD20RD024P1	24VDC	12/8 relay	1	0.360

General characteristics

FUNCTIONS

- Addition-Subtraction on variables
- Multiplication-Division on variables
- Comparator on variables
- HMI display for parameter viewing and programming
- PWM output
- High speed input (1kHz)
- PID function
- Multiplexer
- Analog ramp
- Register transfer (numerical variables and status)
- Shift function
- Boolean logic blocks
- LRD20RD024P1 with RS485 port onboard.

Operational characteristics

- 8A lth current relay outputs for AC and DC versions
- 0.3A 24VDC transistor outputs for DC version
- 0...10V analog inputs for DC version
- Version: modular for mounting on 35mm DIN rail (IEC/EN/BS 60715) or M4x15mm/0.59" screw fixing
- Type of terminal: Screw
- IEC degree of protection: IP20.

Certifications and compliance

Certifications obtained: UL Listed, for USA and Canada (cULus - File E300049), as Programmable Controllers; EAC. Compliant with standards: IEC/EN/BS 61131-2, UL508, CSA C22.2 n°142.

Expansion and communication modules



LRE...

Order code	Auxiliary supply voltage	Inputs/Outputs	Qty per pkg	Wt
			n°	[kg]
Expansion and communication modules❶.				
LRE02AD024	24VDC	2 analog outputs 0...10V/0...20mA	1	0.160
LRE04AD024	24VDC	4 analog inputs 0...10V/0...20mA	1	0.160
LRE04PD024	24VDC	4 PT100 temp. sensor inputs	1	0.160
LRE08RD024	24VDC	4/4 relay	1	0.171
LRE08TD024	24VDC	4/4 transistor	1	0.151
LRE08RA024	24VAC	4/4 relay	1	0.180
LRE08RA240	100...240VAC	4/4 relay	1	0.180
LREP00	RS485 Modbus-RTU protocol communication unit		1	0.134

❶ The expansion modules are supplied with connector for base module.

INPUTS/OUTPUTS REFERENCE TABLE

BASE MODULES				BASE + DIGITAL EXPANSIONS
Type	Power supply	Inputs	Outputs	Max I/O
LRD12RD024	24VDC	6 digital + 2 digital/analog	4 relay	12 + 24
LRD12TD024	24VDC	6 digital + 2 digital/analog	4 transistor	12 + 24
LRD20RD012	12VDC	8 digital + 4 digital/analog	8 relay	20 + 24❷
LRD20RD024	24VDC	8 digital + 4 digital/analog	8 relay	20 + 24
LRD20RD024P1	24VDC	8 digital + 4 digital/analog	8 relay	20 + 24
LRD10RA240	100...240VAC	6 digital	4 relay	10 + 24
LRD20RA240	100...240VAC	12 digital	8 relay	20 + 24
LRD12RA024	24VAC	8 digital	4 relay	12 + 24
LRD20RA024	24VAC	12 digital	8 relay	20 + 24
EXPANSION AND COMMUNICATION MODULES				
LRE02AD024	24VDC	—	2 analog	—
LRE04AD024	24VDC	4 analog	—	—
LRE04PD024	24VDC	4 PT100	—	—
LRE08RD024	24VDC	4 digital	4 relay	—
LRE08TD024	24VDC	4 digital	4 transistor	—
LRE08RA240	100...240VAC	4 digital	4 relay	—
LRE08RA024	24VAC	4 digital	4 relay	—
LREP00	24VDC	RS485 Modbus-RTU protocol slave communication unit		

❷ Expansion modules supplied at 24VDC.

Accessories



LRX1V3D024



LRXM00



LRXC03

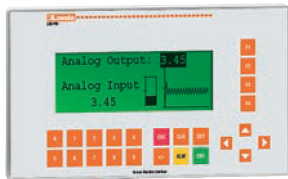

LRXP01



LRXC02

Kit



LRDKIT...

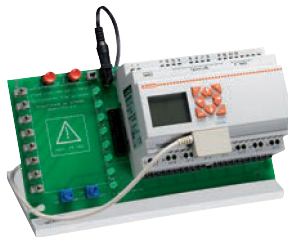

LRDDEM...

Order code	Description	Qty per pkg	Wt
		n°	[kg]
LRXM00	Program backup memory	1	0.011
LRXC00	PC (RS232)-LRD programming cable or LRXP01 (RS232)-LRD direct connection	1	0.083
LRXC03	PC (USB)-LRD programming cable	1	0.080
LRXSW	Programming and supervision software (CD-ROM)	1	0.057
LRX1V3D024	Power supply unit, 100...240VAC/24VDC, 1.3A modular version (4U)	1	0.220
LRXP01	HMI operator panel, 24VDC, RS232, RS485 (Modbus-RTU Master)	1	0.200
LRXC02	PC (RS232)-LRXP01 programming cable	1	0.180
LRXSWP01	Programming software for LRXP01 operator panel (CD-ROM)	1	0.057

Order code	Description	Qty per pkg	Wt
		n°	[kg]
Kits.			
LRDKIT12RD024	LRD starter kit with LRD12RD024 base module, LRXSW software and LRXC03 cable	1	0.424
LRDKIT12RA024	LRD starter kit with LRD12RA024 base module, LRXSW software and LRXC03 cable	1	0.424
LRDKIT10RA240	LRD starter kit with LRD10RA240 base module, LRXSW software and LRXC03 cable	1	0.424
Training kits.			
LRDDEM12RD024	Training kit with LRD12RD024 mounted on inputs/outputs simulation board	1	0.920
LRDDEM20RD024	Training kit with LRD20RD024 mounted on inputs/outputs simulation board	1	1.060

Backup memory and power supply unit general characteristics

- The LRXM00 backup memory allows the saving of the user's program and to simply and quickly transfer it to other base modules.
- The LRX1V3D024 power supply produces a DC voltage to supply the LRD base and expansion modules when 24VDC is not available in the panel. The power supply can also be used to power eventual 24VDC auxiliary circuits.

HMI panel LRXP01 general characteristics

- 24VDC power supply
 - RS232 communication port:
 - Direct connection to LRD base modules using cable LRXC00
 - Connection to other devices using a standard D-SUB 9 serial cable
 - RS485 communication port
 - LRXSWP01 editor software for graphic pages configuration
 - IEC degree of protection: IP65.
- FUNCTIONS
- Send commands
 - Read status
 - Static and dynamic texts
 - Write variables
 - Read variables:
 - Numerical values
 - Bar graphs
 - Trends.

Programming using software LRXSW

At any time and with extreme simplicity, LRD can be set up and reprogrammed to satisfy new requirements and improve the operation of a system.

Programming is simple and intuitive and can be done directly on the base module keypad or by personal computer, connected by LRXC00 (RS232) or LRXC03 (USB) interface and using the relative LRXSW software freely downloadable from www.LovatoElectric.com.

With a personal computer, two programming languages can be used: FBD (Function Block Diagrams) and LADDER (contact scheme).

Both of the following can be accomplished:

- Simulate the program directly "off-line" with a personal computer to test if it runs correctly.
- Use the supervision mode to check the project "on-line".

8 function keys on the front, dedicated to on-board adjustment, control and supervision of digital input and output status, analog input values, time and date entry and the operation status of the micro PLC itself.

Certifications and compliance

Certifications obtained: UL Listed, for USA and Canada (cULus - File E300049), as Programmable Controllers for power supply and HMI units and base module of kits, EAC. Compliant with standards: IEC/EN/BS 61131-2, UL508, CSA C22.2 n°142.

Maximum combinations

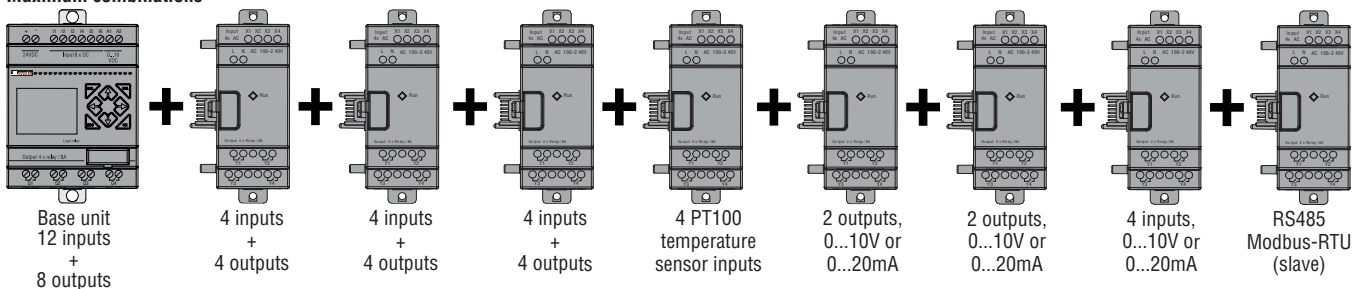

- 24 digital inputs (4 configurable as analog 0...10V input)
- 20 digital outputs (relay, transistor or mixed)
- 4 analog inputs for PT100 temperature sensors
- 4 analog outputs configurable as 0...10V or 0/4...20mA
- 4 analog inputs configurable as 0...10V or 0/4...20mA
- 1 RS485 communication module.

N.B. The sequence and the maximum number of the products given above must be respected for correct operation.

HMI LRH SERIES



- HMI WITH COLOR TOUCHSCREEN DISPLAY**
 The HMI LRH series have a graphic TFT display with 64k colors, touchscreen, easy to program and extremely flexible. They can be interfaced with different type of devices, from PLC to any kind of intelligent controller provided with communication port, like multimeters, drives, process controllers. The LRHSW programming software allows the configuration of the HMI in a simple and intuitive way, thanks to the graphical interface with which you can create customized screens to show images, trends, bar graphs, analog indicators, dynamic objects and other functionalities. The HMI LRH series are the ideal solution for the supervision and control of small and large automation scenarios that are more and more required in the world of Industry 4.0.

- WIDESCREEN DISPLAY WITH HIGH VISIBILITY**
 - TFT display with resistive touchscreen
 - High brightness thanks to the LED backlighting
 - 64k colors
 - Available in formats 4.3", 7" and 10.1".
- SIMPLICITY AND EFFICIENCY**
 - Simple and elegant design with low energy consumption
 - High robustness, thanks to the use of highly reliable industrial components
 - Plastic enclosure, degree of protection IP66, Type 2 and 4X.

- CONNECTIVITY FOR EASY INTEGRATION**
 - 3 built-in communication ports: Ethernet, USB and serial (type RS232-RS485-RS422, configurable via software LRHSW)
 - Support of communication protocols Modbus-RTU Master/Slave, Modbus TCP Client/Server, OPC UA Client/Server, Simatic S7 Ethernet and MQTT.
- POWERFUL AND INTUITIVE PROGRAMMATION**
 - High performance CPU
 - Extensive gallery of widgets, objects and pre-configured scenarios for typical applications
 - Data acquisition and display on numeric indicators, trends or graphical gauges
 - Support of vector graphics, images, analog indicators, bar graphs
 - Advanced functionalities: dynamic objects, alarms and events management, support of multilingual applications, recipes, tags editor, user and password management, script language
 - Advanced properties of the objects: e-mail, events scheduler, etc
 - Support of HTML5 and JavaScript
 - Possibility to simulate the program by working off-line.



Power supply
12-24VDC

USB port

Ethernet port
10/100 MBIT

Serial port
RS485, RS232, RS422



- PRE-CONFIGURED SCENARIOS**
 Preconfigured and ready to use scenarios for typical applications managed with LOVATO Electric products (remote control of a micro PLC, supervision of a pumping station with variable speed drive, monitoring of a photovoltaic system with energy meter, soft starter monitoring, control and supervision of a power factor correction plant, monitoring of an automatic transfer switch ATS panel, command and monitoring of a mains-generator application, etc.) freely downloadable from the website www.LovatoElectric.com, download section, software & upgrades.

HMI



LRHA04



LRHA07

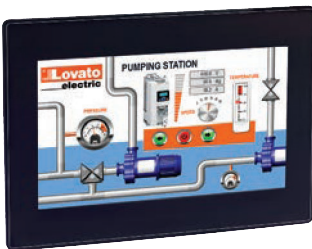

LRHA10



EXCCAB02

Order code	Description	Qty per pkg	Wt
		n°	[kg]
HMI.			
LRHA04	4.3" TFT LCD display	1	0.400
LRHA07	7" TFT LCD display	1	0.600
LRHA10	10.1" TFT LCD display	1	1.000
Programming software for HMI.			
LRHSW01	User licence for LRHSW software (available for download from www.LovatoElectric.com website), valid for 1 station	1	—
LRHSW01CD	CD-ROM with LRHSW programming software, including one LRHSW01 licence	1	0.057
RS485 connection cable.			
EXCCAB02	RS485 connection cable for LRH, length 3m	1	0.150
HMI kits and micro PLC.			
LRDKITHMIA04	Kit with LRD20RD024P1 micro PLC, LRHA04 HMI and EXCCAB02 cable	1	1.000
LRDKITHMIA07	Kit with LRD20RD024P1 micro PLC, LRHA07 HMI and EXCCAB02 cable	1	1.200

Model	LRHA04	LRHA07	LRHA10
SYSTEM RESOURCES			
Display	4.3" TFT 16:9	7" TFT 16:9	10.1" TFT 16:9
Colors	64K		
Resolution	480x272 pixel	800x480 pixel	1024x600 pixel
Brightness	200Cd/m ²		
Dimming	Yes		
Touchscreen	Resistive		
CPU	ARM Cortex A8 300MHz	ARM Cortex A8 1GHz	ARM Cortex A8 1GHz
Operative system	Linux 3.12		
Flash	2GB	4GB	4GB
RAM	256MB	512MB	512MB
Application memory	60MB		
Real Time Clock, RTC backup, Buzzer	Yes		
INTERFACES			
Ethernet	1 (10/100 Mbit)		
USB	1 (Host v2.0, max 500mA)		
Serial	1 (RS232, RS485, RS422, software configurable)		
FUNCTIONALITIES			
Vector graphics	●		
Dynamic objects	●		
Font TrueType	●		
Alarms	●		
Event list	●		
Recipes	●		
User management	●		
Trends	●		
Multi-language management	●		

General characteristics

- Widescreen display with resistive touchscreen
- Available in formats 4.3", 7" and 10.1"
- LED backlight
- Ethernet, USB and serial port (type RS232-RS485-RS422, configurable via software LRHSW)
- Lightweight and low-power design
- Highly reliable industrial components
- Powerful and intuitive programming with software LRHSW (downloadable from the website www.LovatoElectric.com or purchasable on Cd-rom), with 30-days trial license included
- Support of protocols Modbus-RTU Master/Slave, Modbus-TCP Client/Server, OPC UA Client/Server, Simatic S7 Ethernet and MQTT
- Support of vector graphics
- Rich library of preconfigured and ready to use graphical objects (widgets): static or dynamic images, buttons, sliders, lights, bar graphs, gauges, meters, media widgets, etc.
- Possibility to create custom widgets
- Tags editor to create, import or export tags
- Alarm handling with management of events and actions (e.g. alerts with pop-up messages, send email, write tags, etc.)
- Data-logging with presentation of the collected data in graphical trends and tables, with possibility to save the data in a .CSV file
- Recipe data handling
- Scheduler engine to execute specific actions at set intervals, or on a time basis
- Automatic generation of customizable reports
- Multilingual projects management with texts in True Type font
- Data transfer function to exchange data between the devices connected to the HMI
- Powerful script language with JavaScript editor
- Web access: support of HTML5 technology to allow users to access HMI projects from a remote web browser running on a computer or on a mobile device (smartphone or tablet)
- Advanced user management with possibility to configure different levels of authorizations and permissions on the access to pages or to the actions on the widgets of the projects, with dedicated credentials
- Monitoring and remote control of the project running on the HMI from a PC with the software LRHSW Client, installed together with the programming software LRHSW
- On-line and off-line simulation of the applications.

Operational characteristics

- Rated auxiliary power supply: 12-24VDC
- Operating range: 10...32VDC
- Operating temperature: 0...+50°C
- Storage temperature: -20...+70°C
- Humidity: 5-85% RH, non condensing
- Protection degree: IP66, Type 2 and 4X (front); IP20 (rear).

Preconfigured scenarios

Preconfigured and ready to use scenarios for typical applications managed with LOVATO Electric products (remote control of a micro PLC, supervision of a pumping station with variable speed drive, monitoring of a photovoltaic system with energy meter, soft starter monitoring, control and supervision of a power factor correction plant, monitoring of an automatic transfer switch ATS panel, command and monitoring of a mains-generator application, etc.) freely downloadable from the website www.LovatoElectric.com, download section software & upgrades.

Certifications and compliance

Certifications obtained: UL Listed, for USA and Canada (cULus – File E199715), EAC, RCM.
Compliant with standards: emissions EN/BS 61000-6-4, immunity EN/BS 61000-6-2 for installation in industrial environments; emissions EN/BS 61000-6-3, immunity EN/BS 61000-6-1 for installation in residential environments; UL508.

BASE MODULES
LRD10... - LRD12...

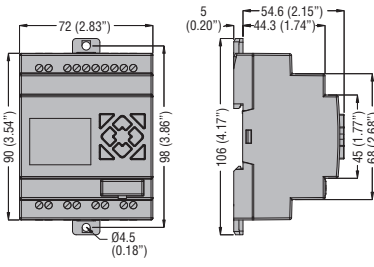

LRD20...

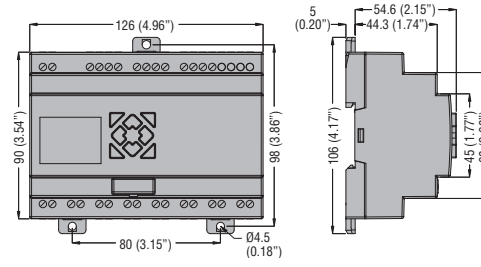

EXPANSION AND COMMUNICATION MODULES
LRE...

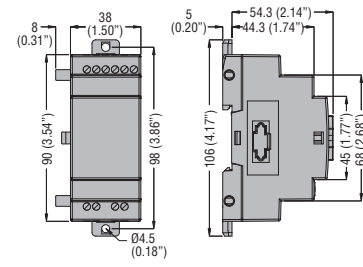

ACCESSORIES

LRX1V3D024 power supply unit

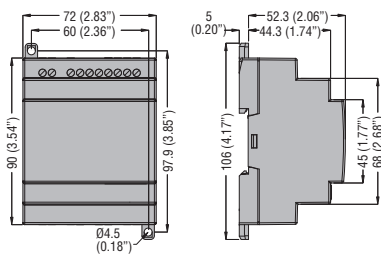

LRXP01 HMI operator panel

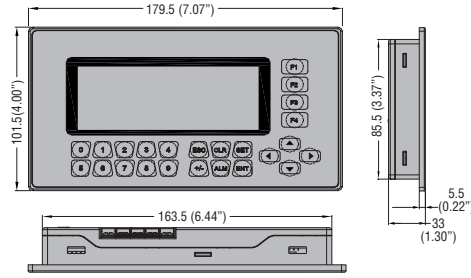

Cutout

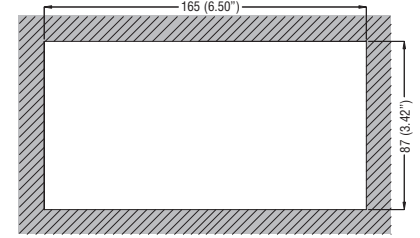

HMI

LRHA04

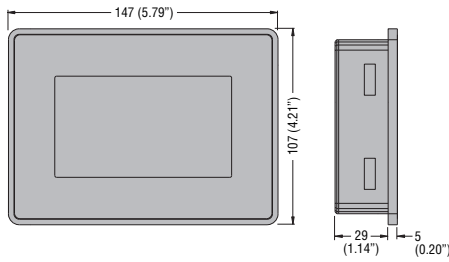

Cutout

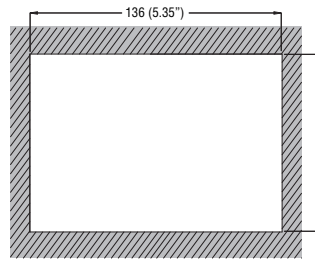

LRHA07

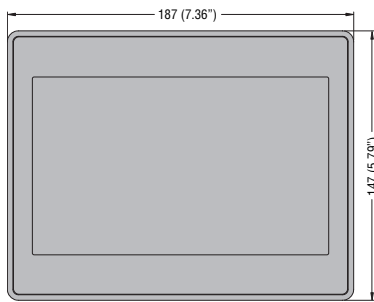

Cutout

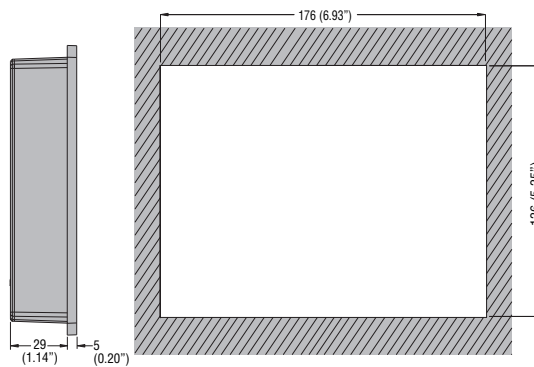

LRHA10

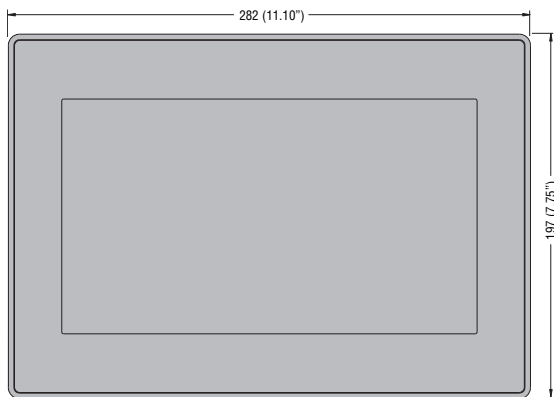

Cutout

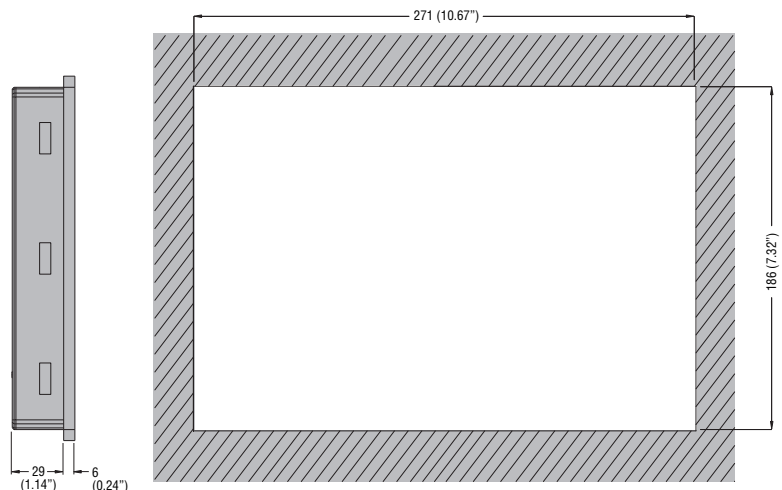

BASE MODULES

LRD12RD024

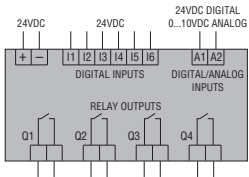

LRD12TD024

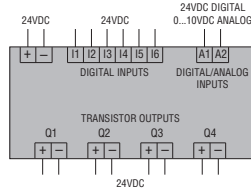

LRD12RA024

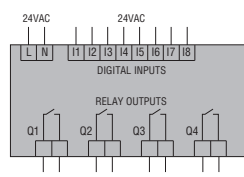

LRD10RA240

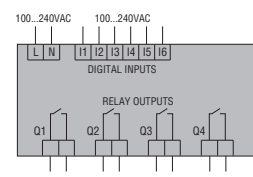

LRD20RD012 - LRD20RD024

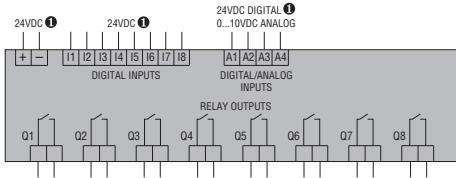

① 12VDC for LRD20RD012.

LRD20RD024P1

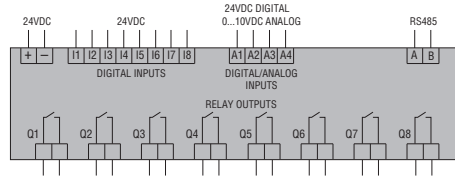

LRD20RA024

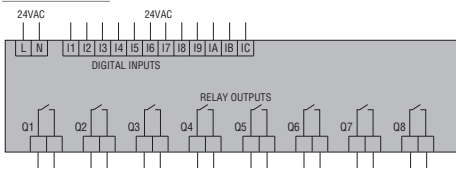

LRD20RA240

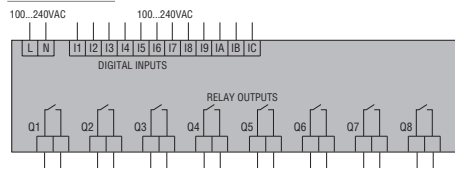

EXPANSION AND COMMUNICATION MODULES

LRE02AD024

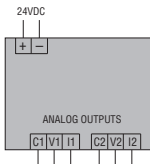

LRE04AD024

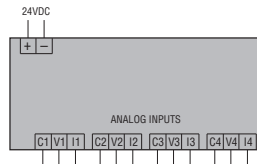

LRE04PD024

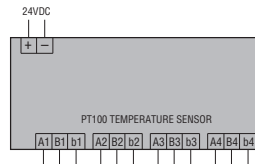

LRE08RD024

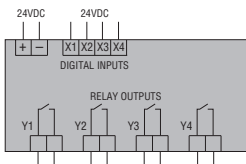

LRE08TD024

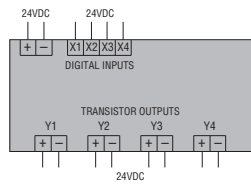

LRE08RA024

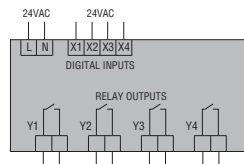

LRE08RA240

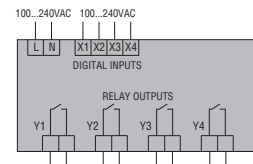

ACCESSORIES

Power supply unit

LRX1V3D024

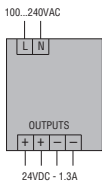

RS485 communication unit

LREP00



Operation panel

L_RXP01

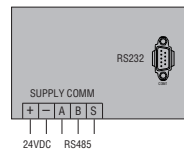

HMI

LRHA...

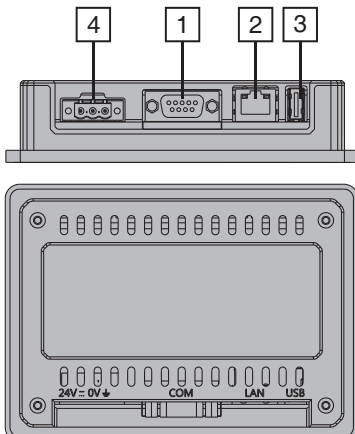

- 1 Serial port (type RS232, RS485, RS422 software configurable)
- 2 Ethernet port
- 3 USB port
- 4 Power supply 12-24VDC

BASE MODULES		LRD...D012		LRD...D024		LRD...A024		LRD...A240	
POWER SUPPLY									
IEC rated voltage U _e (frequency range)		12VDC		24VDC		24VAC (50...60Hz)		100...240VAC (50...60Hz)	
Operating limits		10.4...14.4VDC		20.4...28.8VDC		20.4...28.8VAC (47...63Hz)		85...265VAC (47...63Hz)	
Average current consumption		265mA		125mA (LRD12...) 185mA (LRD20...)		290mA		100mA	
DIGITAL INPUTS									
Rated voltage		12VDC		24VDC		24VAC (50...60Hz)		100...240VAC (50...60Hz)	
Input voltage	State 0	<2.5VDC		<5VDC		<6VAC		<40VAC	
	State 1	>7.5VDC		>15VDC		>14VAC		>79VAC	
Delay time	0 to 1	4ms (0.5ms for high speed)		4ms (0.5ms for high speed)		90ms		50/45ms (U _e =120VAC) - 22/18ms (U _e =240VAC)	
	1 to 0	4ms (0.3ms for high speed)		4ms (0.3ms for high speed)		90ms		50/45ms (U _e =120VAC) - 90/85ms (U _e =240VAC)	
ANALOG INPUTS (FOR DC SUPPLY VERSIONS ONLY)									
Input signal range		0...10V		—		—		—	
Display resolution		0.01V		—		—		—	
Current consumption at 10VDC		<0.17mA		—		—		—	
Input impedance		>40kΩ		—		—		—	
Admissible overload		14VDC		28VDC		—		—	
Sampling time		5...20ms (LADDER); 2...10ms (FBD)		—		—		—	
Maximum cable length		≤30m/98ft of screened type		—		—		—	
DIGITAL OUTPUTS									
Type of output / IEC rated current I _{th}		Relay / 8A (LDR...R... / LRE08R... only) Transistor / 0.3A 24VDC (LRD...T... / LRE08T... only)							
Applied voltage		Max 265VAC / 30VDC (LDR...R... / LRE08R... only) 10...28.8VDC (LRD...T... / LRE08T... only)							
AMBIENT CONDITIONS									
Operating temperature		-20...+55°C							
Storage temperature		-40...+70°C							
Relative humidity		20...90% without condensation							
HOUSING									
Version		Modular for mounting on 35mm DIN rail (IEC/EN/BS 60715) or M4x20mm screw fixing							
Connections	Type of terminal	Screw							
	Conductor section	0.14...2.5mm ² / 26...14AWG							
	Tightening torque	0.6Nm / 5.3lb.in							
	Maximum cable length	≤100m/328ft							
IEC degree of protection		IP20							

EXPANSION MODULES		LRE02AD024		LRE04AD024		LRE04PD024	
POWER SUPPLY							
IEC rated voltage U _e		24VDC		24VDC		24VDC	
Operating limits		20.4...28.8VDC		20.4...28.8VDC		20.4...28.8VDC	
ANALOGIC INPUTS/OUTPUTS							
Type of channels		2 outputs configurable for voltage or current		4 inputs configurable for voltage or current		4 inputs for PT100 temperature sensors	
Operating limits		0...10V 0...20mA		0...10V 0...20mA		-100...+600°C	
Display resolution		0.00...10.00V 0.00...20.00mA		0.00...10.00V 0.00...20.00mA		-100.0...+600.0°C	
Resolution		10mV 40μA		10mV 40μA		0.1°C	
Accuracy		±2.5%		±2.5%		±1%	
Power consumption		70mA		70mA		70mA	

COMMUNICATION MODULE		LREP00	
IEC rated voltage U _e		24VDC	
RS485 connection		Isolated	
Baud-rate		4800...57600bps	
Terminator resistor		Integrated 120Ω	
Cable length		0.14...1.5mm ² (26...16AWG)	
Tightening torque		0.6Nm (5.4lb.in)	

HMI OPERATOR PANEL	LRXP01
SUPPLY	
IEC rated voltage Ue	24VDC
Operating limits	20.4...26.4 VDC (-15%...+10%)
Power consumption	1.9 W
AMBIENT CONDITIONS	
Operating temperature	0...+55°C
Storage temperature	-40...+70°C
Altitude	≤2000m
Relative humidity	10...95% (non-condensing)
Maximum pollution degree	2 (IEC/EN/BS 61131-3)
Vibration resistance	15g
Shock resistance	0.5g
Conductor section	0.4...3.3 mm ² (22-12 AWG)
Tightening torque	1.8 Nm / 10.4lb.in
IEC degree of protection	IP65

HMI	LRHA04	LRHA07	LRHA10
POWER SUPPLY			
Rated voltage Ue	12-24VDC		
Operating range	10...32VDC		
Max current consumption at 24VDC	0.25A	0.3A	0.38A
ENVIRONMENT CONDITIONS			
Operating temperature	0...+50°C		
Storage temperature	-20...+70°C		
Relative humidity	5...85% (non condensing)		
Protection degree	IP66, Type 2, 4X (front); IP20 (rear)		



- Versions: modular and 35mm DIN rail mount
- Output voltage adjustment by front potentiometer
- Short-circuit protection
- Built-in input voltage surge suppressor
- Used as power supply for DC electromechanical and electronic equipment
- Redundancy modules

	SEC. - PAGE
Modular switching power supplies	
Single phase	23 - 2
Compact DIN rail mount switching power supplies	
Single phase	23 - 2
DIN rail mount switching power supplies	
Single phase	23 - 3
Two phase	23 - 3
Three phase	23 - 3
Redundancy modules	23 - 3
Dimensions	23 - 4
Wiring diagrams	23 - 5
Technical characteristics	23 - 6



Page 23-2

**POWER SUPPLIES DIN RAIL MOUNT
MODULAR VERSION**

- Single phase
- Output voltage: 12 or 24VDC
- Output power: 10...100W.



Page 23-2

**POWER SUPPLIES DIN RAIL MOUNT
COMPACT VERSION**

- Single phase
- Output voltage: 24VDC
- Output power: 30...120W.



Page 23-3

**POWER SUPPLIES DIN RAIL MOUNT
VERSION**

- Single, two and three phase
- Output voltage: 24 or 48VDC
- Output power: 5...960W.



Page 23-3

REDUNDANCY MODULES

- Modular and 35mm DIN rail mount
- Output voltage: 12 or 24VDC
- Output current: 10 or 20A.

Modular version



PSL1M010...



PSL1M03312
PSL1M03624

Order code	Rated output voltage	Rated output current	Output power	Qty per pkg	Wt
	[V]	[A]	[W]	n°	[kg]
Single phase.					
PSL1M01012	12VDC	0.83	10	1	0.065
PSL1M02412		2	24	1	0.130
PSL1M03312		2.75	33	1	0.190
PSL1M05412		4.5	54	1	0.250
PSL1M07212		6	72	1	0.380
PSL1M01024	24VDC	0.42	10	1	0.065
PSL1M02424		1	24	1	0.130
PSL1M03624		1.5	36	1	0.190
PSL1M06024		2.5	60	1	0.250
PSL1M10024		4.2	100	1	0.380

General characteristics

Switching power supplies transform an AC input voltage into a DC output one. This type of equipment is used in industrial and domestic automation fields. The power supplies are equipped with switching technology offering very high efficiency in an extremely compact size. Dimensions are compatible with modular consumer panels and its plastic housing is suitable for building automation installations as well as industrial automation applications. The wide range of power supply voltages and the choice of DC current outputs provide for the best adaptability to supply voltage needs of the most common electronic and electromechanical devices.

Protections:

- Short circuit
- Overload
- Input voltage peaks.

Indications:

- LED indicator for low voltage conditions
- LED indicator for power on.

Operational characteristics

- Rated supply voltage: 100...240VAC
- Rated output voltage: 12VDC for PSL1M...12 types; 24VDC for PSL1M...24 types
- Mains frequency: 50/60Hz
- Output voltage adjustment by front potentiometer (except for PSL1M010...)
- High efficiency up to 89%
- 35mm DIN rail (IEC/EN/BS 60715) mounting
- Screw connection terminals
- Modular DIN 43880 housing; number of modules:
 - 1 for PSL1M010...
 - 2 for PSL1M024...
 - 3 for PSL1M03312 and PSL1M03624
 - 4 for PSL1M05412 and PSL1M06024
 - 5 for PSL1M07212 and PSL1M10024
- IEC degree of protection: IP20 on terminals.

Certifications and compliance

Certifications obtained: UL Listed for USA and Canada (cULus-File E318016) as Power Supplies in power circuit and motor-mounted apparatus category; EAC, RCM. Compliant with standards: IEC/EN/BS 62368-1, IEC/EN/BS 61000-6-2, IEC/EN/BS 61000-6-3, UL508, CSA C22.2 n° 107-1.

Compact DIN rail mount version



PSE1...

new

Order code	Rated output voltage	Rated output current	Output power	Qty per pkg	Wt
	[V]	[A]	[W]	n°	[kg]
Single phase.					
PSE103024	24VDC	1.25	30	1	0.140
PSE105024		2.1	50	1	0.200
PSE107224		3	72	1	0.250
PSE110024		4.2	100	1	0.350
PSE112024		5	120	1	0.610

General characteristics

The PSE1... power supplies have compact dimensions and are DIN rail mountable. They are used to supply electromechanical and electronic devices with DC control, such as contactors, time relays, sensors, PLCs, DC motors, displays, SSRs and other equipment normally found in automation systems.

Protections:

- Short circuit
- Overload
- Input voltage peaks.

Indications:

- LED indicator for power on.

Operational characteristics

- Rated supply voltage: 100...240VAC
- Rated output voltage: 24VDC
- Mains frequency: 50/60Hz
- Output voltage adjustment by front potentiometer
- High efficiency up to 89%
- 35mm DIN rail (IEC/EN/BS 60715) mounting
- Screw connection terminals
- IEC degree of protection: IP20 on terminals.

Certifications and Compliance

Certifications obtained: cULus (pending for PSE112024), EAC, RCM. Compliant with standards: IEC/EN/BS 62368-1, IEC/EN/BS 61000-6-2, IEC/EN/BS 61000-6-3, UL508, CSA C22.2 No. 107.1.

DIN Rail mount version



PSL100524
PSL101024
PSL101824

PSL1030...
PSL1060...



PSL1100...
PSL1240...
PSL1300...



PSL148024
PSL148048



PSL3960...

Order code	Rated output voltage [V]	Rated output current [A]	Output power [W]	Qty per pkg n°	Wt [kg]	
Single phase.						
PSL100524	24VDC	0.21	5	1	0.120	
PSL101024		0.42	10	1	0.120	
PSL101824		0.75	18	1	0.150	
PSL103024		1.25	30	1	0.270	
PSL106024		2.5	60	1	0.340	
PSL110024		4.2	100	1	0.430	
PSL112024		5	120	1	0.920	
PSL124024		10	240	1	1.380	
PSL130024		12.5	300	1	1.400	
PSL148024		20	480	1	1.920	
PSL103048		48VDC	0.625	30	1	0.270
PSL106048			1.25	60	1	0.340
PSL110048			2.1	100	1	0.430
PSL112048			2.5	120	1	0.920
PSL124048	5		240	1	1.380	
PSL130048	6.25		300	1	1.400	
PSL148048	10		480	1	1.920	

Two phase.					
PSL210024	24VDC	4.2	100	1	0.500
PSL210048	48VDC	2.1	100	1	0.500

Three phase ^① .					
PSL312024	24VDC	5	120	1	0.800
PSL324024		10	240	1	1.100
PSL348024		20	480	1	1.720
PSL396024	48VDC	40	960	1	3.400
PSL324048		5	240	1	1.100
PSL348048		10	480	1	1.720
PSL396048		20	960	1	3.400

① Two-phase connection is admissible with a 25% output power derating.

General characteristics

This type of equipment is used to power supply electromechanical and electronic devices with DC control, such as contactors, time relays, sensors, PLCs, DC motors, displays, SSRs and other equipment normally found in automation systems and networks.

Protections:

- Short circuit
- Overload
- Input voltage peaks.

Indications:

- LED indicator for low voltage conditions
- LED indicator for power on.

Operational characteristics

- Rated supply voltage:
100...240VAC (PSL1005...PSL1100...)
115/230VAC self-configurable (PSL1120...PSL1480...)
400...500VAC (PSL2... and PSL3...)
- Rated output voltage: 24VDC (PSL...24) / 48VDC (PSL...48)
- Mains frequency: 50/60Hz
- Output voltage adjustment by front potentiometer
- PFC function for types:
PSL112024...PSL396024
PSL112048...PSL396048
- Parallel connection for types: PSL1100...PSL3960... (except for PSL312024)
- High efficiency up to 93%
- 35mm DIN rail (IEC/EN/BS 60715) mounting
- Screw connection terminals
- Plastic or metal housing depending on type
- IEC degree of protection: IP20 on terminals.

Certifications and compliance

Certifications obtained: UL Listed for USA and Canada (cULus-File E318016) as Power Supplies in power circuit and motor-mounted apparatus category; EAC, RCM. Compliant with standards: IEC/EN/BS 62368-1, IEC/EN/BS 61000-6-2, IEC/EN/BS 61000-6-3, UL508, CSA C22.2 n° 107.1.

Redundancy modules



PSLRM1024



PSLR2024

Order code	Rated voltage [V]	Rated output current [A]	Qty per pkg n°	Wt [kg]
Modular version DIN rail mount version.				
PSLRM1024	12...24VDC	10	1	0.075
DIN rail mount version.				
PSLR2024	24VDC	20	1	0.210

Indications (PSLR2024)

Input voltage A	Input voltage B	LED A	LED B	Relay A	Relay B
Within limits	Within limits	ON	ON	Energ.	Energ.
Within limits	<MIN or >MAX	ON	OFF	Energ.	De-energ.
<MIN or >MAX	Within limits	OFF	ON	De-energ.	Energ.
<MIN or >MAX	<MIN or >MAX	OFF	OFF	De-energ.	De-energ.

General characteristics

They are used for the redundancy connection of two or more power supplies to enhance the reliability of the DC supply. The redundancy modules ensure a perfect insulation between the power supplies connected.

Indications (only for PSLR2024):

- LED indicator for DC voltage within limit
- Alarm relay.

Operational characteristics

- Rated input voltage:
12...24VDC (PSLRM1024)
24VDC (PSLR2024)
- Rated input current:
10A (PSLRM1024)
20A (PSLR2024)
- Rated output current :
10A (PSLRM1024)
20A (PSLR2024)
- Maximum output current:
16A per 300s (PSLRM1024)
30A per 300s (PSLR2024)
- Modular housing DIN 43880 2 modules (PSLRM1024)
- 35mm DIN rail mounting (IEC/EN/BS 60715)
- Screw connection terminals
- Plastic housing
- IEC degree of protection: IP20 on terminals.

Certifications and compliance

Certifications obtained: cULus (only for PSLR2024), EAC, RCM. Compliant with standards: IEC/EN/BS 62368-1 (only for PSLR2024), IEC/EN/BS 61000-6-2, IEC/EN/BS 61000-6-3, UL508 (only for PSLR2024), CSA C22.2 n°107.1 (only for PSLR2024).

23 Switching power supplies

Dimensions [mm (in)]

MODULAR SWITCHING POWER SUPPLIES

PSL1M010...

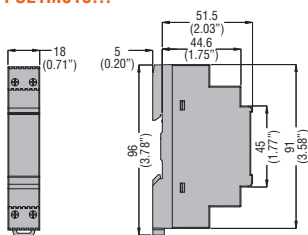

PSL1M024...

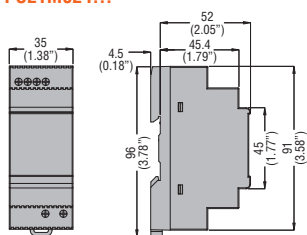

PSL1M03312 - PSL1M03624

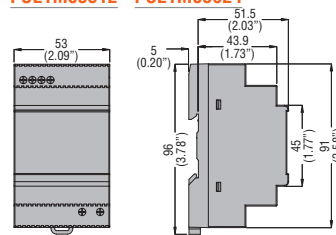

PSL1M05412 - PSL1M06024

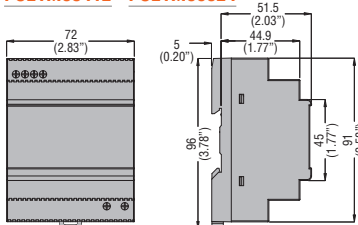

PSL1M07212 - PSL1M10024

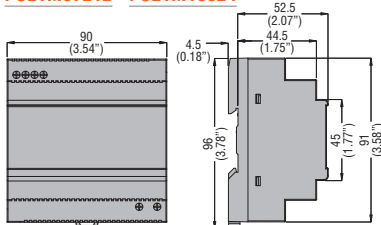

COMPACT DIN RAIL MOUNT SWITCHING POWER SUPPLIES

PSE103024

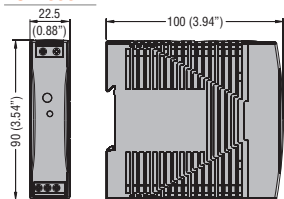

PSE105024

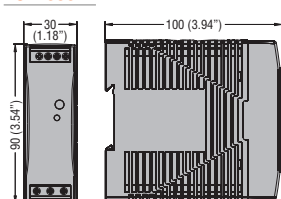

PSE107224

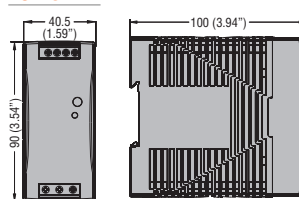

PSE110024

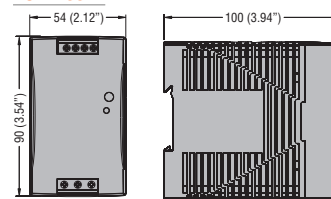

PSE112024

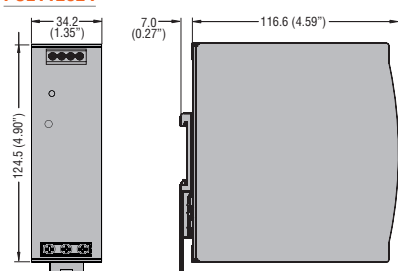

DIN RAIL MOUNT SWITCHING POWER SUPPLIES

PSL100524...PSL110048

PSL2100...

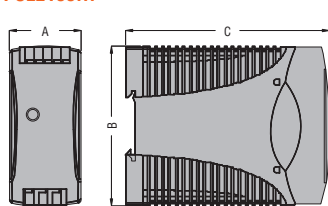

TYPE	A	B	C
PSL100524	22.5 (0.88")	90 (3.54")	115 (4.53")
PSL101024	22.5 (0.88")	90 (3.54")	115 (4.53")
PSL101824	22.5 (0.88")	90 (3.54")	115 (4.53")
PSL1030...	40.5 (1.59")	90 (3.54")	115 (4.53")
PSL1060...	40.5 (1.59")	90 (3.54")	115 (4.53")
PSL1100...	54 (2.12")	90 (3.54")	115 (4.53")
PSL2100...	54 (2.12")	90 (3.54")	115 (4.53")

PSL112024...PSL148048

PSL3...

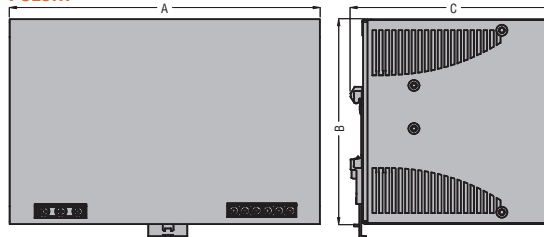

TYPE	A	B	C
PSL1120...	64 (2.52")	124.5 (4.90")	123.6 (4.87")
PSL1240...	83.5 (3.29")	124.5 (4.90")	123.6 (4.87")
PSL1300...	83.5 (3.29")	124.5 (4.90")	123.6 (4.87")
PSL1480...	175.5 (6.91")	124.5 (4.90")	125 (4.92")
PSL312024	74.3 (2.92")	124 (4.88")	118.8 (4.68")
PSL3240...	89 (3.50")	124 (4.88")	118.8 (4.68")
PSL3480...	150 (5.90")	124 (4.88")	118.8 (4.68")
PSL3960...	275.8 (10.86")	125.9 (4.96")	120.9 (4.76")

REDUNDANCY MODULES

PSLRM1024

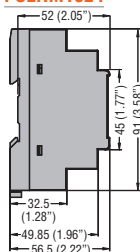

PSLR2024

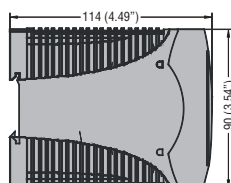

MODULAR SWITCHING POWER SUPPLIES

PSL1M0102

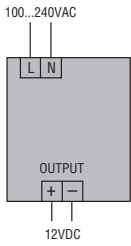

PSL1M01024

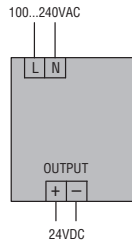

PSL1M02412 - PSL1M03312 PSL1M05412 - PSL1M07212

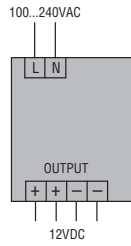

PSL1M02424 - PSL1M03624 PSL1M06024 - PSL1M10024

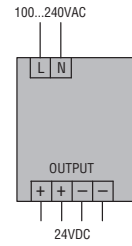

COMPACT DIN RAIL MOUNT SWITCHING POWER SUPPLIES

PSE103024

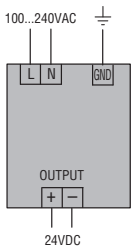

PSE105024 - PSE107224 PSE110024 - PSE112024

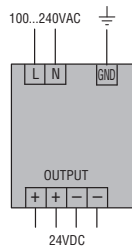

DIN RAIL MOUNT SWITCHING POWER SUPPLIES

PSL100524 PSL101024 PSL101824

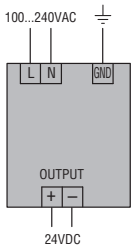

PSL1030... PSL1060...

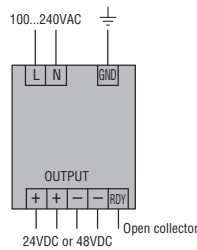

PSL1100...

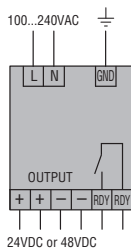

PSL1120... PSL1240... - PSL1300... PSL1480...

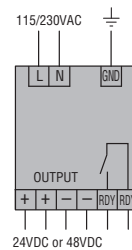

PSL2100...

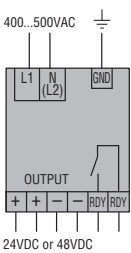

PSL312024 - PSL3240...^① PSL3480...^① - PSL3960...^①

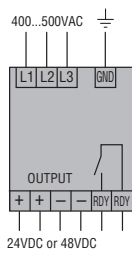

① Two-phase connection is permissible with a 25% output power derating.

REDUNDANCY MODULES

PSLRM1024

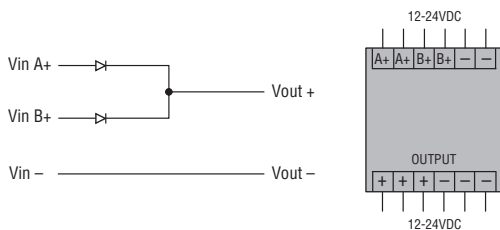

PSLR2024

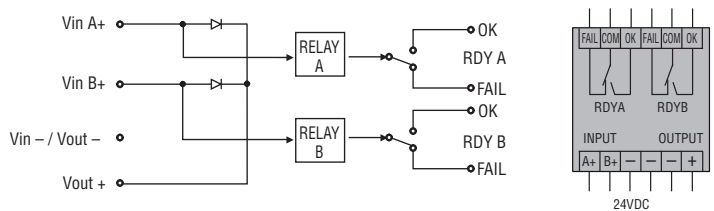

MODULAR SWITCHING POWER SUPPLIES PSL1M... TYPES

TYPE	Single phase	PSL1M01012 - PSL1M01024	PSL1M02412 - PSL1M02424	PSL1M03312 - PSL1M03624	PSL1M05412 - PSL1M06024	PSL1M07212 - PSL1M10024
INPUT CHARACTERISTICS						
Rated supply voltage	Multivoltage 100...240VAC					
Operating range	90...264VAC / 120...375VDC					
Consumption (max)	300mA	600mA	900mA	1.5A	1.7/2.2A	
Frequency range	47...63Hz					
PFC	—					
Insulation voltage Input/output	3000VAC (4242VDC)					
Internal fuse ❶	T1A 250VAC	T2A 250VAC			T3A 250VAC	
OUTPUT CHARACTERISTICS						
Voltage	12VDC (PSL1M...12); 24VDC (PSL1M...24)					
Voltage trimming (potentiometer)	—	12...14VDC (PSL1M...12) 24...28VDC (PSL1M...24)				
Current	0.83A (PSL1M...12) 0.42A (PSL1M...24)	2A (PSL1M...12) 1A (PSL1M...24)	2.75A (PSL1M...12) 1.5A (PSL1M...24)	4.5A (PSL1M...12) 2.5A (PSL1M...24)	6A (PSL1M...12) 4.2A (PSL1M...24)	
Temperature coefficient	±0.03%/°C					
Line adjustment	±1%					
Load adjustment	±1%					
Efficiency	78% (PSL1M...12) 80% (PSL1M...24)	84% (PSL1M...12) 85% (PSL1M...24)	83% (PSL1M...12) 84% (PSL1M...24)	84% (PSL1M...12) 86% (PSL1M...24)	86% (PSL1M...12) 89% (PSL1M...24)	
Overload protection	125...185%	120...160%	110...150%	110...150%	110...150%	
Short-circuit protection	Hiccup	Hiccup	Fold forward			
Ripple noise	50mV					
Parallel connection (n° of units)❷	—					
INDICATIONS						
LED indicator for power on	Yes					
LED indicator for low voltage	Yes					
Power Rdy (Ready) output	—					
AMBIENT CONDITIONS						
Operating temperature ❸	-40...+71°C					
Derating of the output power	from +61°C to +71°C by 2.5%/°C		from +56°C to +71°C by 2.5%/°C		from +61°C to +71°C by 2.5%/°C	
Storage temperature	-40...+85°C					
HOUSING						
Material	Plastic					

❶ No replacement by user.

❷ Minimum load of 150mA.

❸ Maximum surrounding temperature of 50°C for use according to UL508.

COMPACT DIN RAIL MOUNT SWITCHING POWER SUPPLIES **PSE1...** TYPES

	<u>PSE103024</u>	<u>PSE105024</u>	<u>PSE107224</u>	<u>PSE110024</u>	<u>PSE112024</u>
Multivoltage 100...240VAC					
85...264VAC / 120...375VDC					
	750mA	1.3A	1.7A	2.3A	2.9A
47...63Hz					
-					
3000VAC (4242VDC)					
	T2A 250VAC	T2A 250VAC	T3.15A 250VAC	T3.15A 250VAC	T4A 250VAC
24VDC					
22.5...28.5VDC					
	1.25A	2,1A	3A	4,2A	5A
±0.03%°C					
±1%					
±1%					
	Up to 86%	Up to 87%	Up to 89%	Up to 88%	Up to 89%
140%					
Hiccup					
100mV					
-					
Yes					
-					
-					
-25...+71°C					
from +51°C (+46°C for PSE110024) to +71°C by 2.5%/°C					
-40...+85°C					
Plastic					Metallic

DIN RAIL MOUNT SWITCHING POWER SUPPLIES PSL... TYPES								
TYPE	Single phase	PSL100524	PSL101024	PSL101824	PSL103024 PSL103048	PSL106024 PSL106048	PSL110024 PSL110048	
	Two phase	—	—	—	—	—	—	
	Three phase	—	—	—	—	—	—	
INPUT CHARACTERISTICS								
Rated supply voltage	Multivoltage 100...240VAC							
Operating range	90...264VAC / 120...375VDC			85...264VAC / 90...375VDC			90...264VAC 120...375VDC	
Consumption (max)	200mA	300mA	500mA	800mA	1.5A	2.4A		
Frequency range	47...63Hz							
PFC	—							
Insulation voltage Input/output	3000VAC (4242VDC)							
Internal fuse ❶	T2A 250VAC						T3.15A 250VAC	
OUTPUT CHARACTERISTICS								
Voltage	24VDC (PSL...24); 48VDC (PSL...48)							
Voltage trimming (potentiometer)	21.6...28.8VDC			24...28VDC 48...55VDC			22.5...28.5VDC 47...56VDC	
Current	0.21A	0.42A	0.75A	1.25A 0.625A	2.5A 1.25A	4.2A 2.1A		
Temperature coefficient	±0.03%/°C							
Line adjustment	±1%			±0.5%			±1%	
Load adjustment	±2%			±0.5%			±1%	
Efficiency	72%	76%	77%	86%	89%	86% 88%		
Overload protection	110...165%			110...150%			110...140%	
Short-circuit protection	Hiccup			Fold forward				
Ripple & noise	50mV							
Parallel connection (n° of units)❸	—						3	
INDICATIONS								
LED indicator for power on	Yes							
LED indicator for low voltage	Yes			—			Yes	
Power Rdy (Ready) output	—			Yes			Yes	
AMBIENT CONDITIONS								
Operating temperature ❹	-20...+71°C			-40...+71°C			-35...+71°C	
Storage temperature	-25...+85°C			-40...+85°C				
Derating of the output power	from +61°C to +71°C by 2.5%/°C							
HOUSING								
Material	Plastic							
❶ No replacement by user. ❷ Two-phase connection is possible with 25% power derating, except types PSL2100... and PSL312024. ❸ Minimum load of 150mA. ❹ Maximum surrounding temperature of 50°C for use according to UL508.								

PSL112024 PSL112048	PSL124024 PSL124048	PSL130024 PSL130048	PSL148024 PSL148048	—	—	—	—	—
—	—	—	—	PSL210024 PSL210048	—	—	—	—
—	—	—	—	—	PSL312024	PSL324024 PSL324048	PSL348024 PSL348048	PSL396024 PSL396048
Self-configurable 115/230VAC				Multivoltage 400...500VAC Ⓢ				
90...132VAC / 180...264VAC 210...375VDC			90...264VAC 120...375VDC	340...575VAC 480...820VDC				
2.8A	5.4A	6A	7A	750mA	500mA	850mA	1.4A	2.4A
47...63Hz								
0.7	0.75		0.97	0.55			0.65	0.8
3000VAC (4242VDC)								
T3.15A 250VAC	T6.3A 250VAC	T8A 250VAC	T10A 250VAC	T2A 600VAC			T3.15A 500VAC	T5A 500VAC
24VDC (PSL...24); 48VDC (PSL...48)								
22.5...28.5VDC 47...56VDC				22.5...28.5 VDC	22.5...28.5VDC 47...56VDC			
5A 2.5A	10A 5A	12.5A 6.25A	20A 10A	4.2A 2.1A	5A	10A 5A	20A 10A	40A 20A
0.03%/°C								
±0.5%				±1%				
±1%								
86% 87%	89% 90%	89% 90%	87% 89%	89%	90% 91%	90% 91%	92% 93%	
110...145%	120...145%		110...140%	115...135%		120...140%	110...135%	
Fold forward				Hiccup			Fold forward	Hiccup
50mV	100mV			50mV	100mV			80mV
3				2	—	2	2	3
Yes								
Yes								
Yes								
-35...+71°C	-40...+71°C	-30...+71°C	-40...+71°C			-30...+71°C	-40...+71°C	
-40...+85°C								
from +61°C to +71°C by 2.5%/°C		from +56°C to +71°C by 2.5%/°C		from +61°C to +71°C by 2.5%/°C			3.5%/°C (>60°C)	
Metal				Plastic	Metal			

REDUNDANCY MODULES PSLR...

TYPE	PSLRM1024	PSLR2024
INPUTS CHARACTERISTICS		
Rated input voltage	12-24VDC	24VDC
Operating range	9...35VDC	21...28VDC
Number of input	2	2
Rated input current	10A	20A
Maximum input current (for channel)	8A for 300s	15A for 300s
OUTPUTS CHARACTERISTICS		
Output voltage drop	0.5V	0.5V
Rated output current	10A	20A
Maximum reverse voltage	35V	30V
Maximum output current	16A for 300s	30A for 300s
INDICATIONS		
DC ON indicator for input A	-	Yes
DC ON indicator for input B	-	Yes
Power Rdy (Ready) output	-	Ok if input >20V (±5%) or <30V(±5%) Fail if input <20V (±5%) or >30V(±5%) Rating 1A 30VDC
AMBIENT CONDITIONS		
Operating temperature / Storage temperature	-40...+71°C / -40...+85°C	
HOUSING		
Material	Plastic	Plastic



- Switching and linear technology
- 1 charging level
- Versions for non-sealed and sealed lead-acid batteries, 1.25 to 12A ratings
- Charging current limitation selectable.

Automatic battery chargers for lead-acid batteries

	SEC. - PAGE
Switching BCF series, modular version	24 - 2
Switching BCG series	24 - 3
Linear BCE series	24 - 4
Dimensions	24 - 5
Wiring diagrams	24 - 6
Technical characteristics	24 - 7



Page 24-2

SWITCHING BATTERY CHARGERS MODULAR VERSION

- For lead-acid batteries up to 50Ah rating
- Rated output current:
 - 2.5 and 4.5A at 12VDC
 - 1.25 and 2.5A at 24VDC
- Electronic lock for shorted battery, reverse polarity and output overload
- Automatic reset at end of alarm conditions
- Output for alarm remote indication.



Page 24-3

SWITCHING BATTERY CHARGERS

- For lead-acid batteries up to 150Ah rating
- Rated output current:
 - 6A and 12A at 12VDC
 - 5A and 10A at 24VDC
- Electronic lock for shorted battery, reverse polarity and output overload
- Automatic reset at end of alarm conditions
- Output for alarm remote indication.



Page 24-4

LINEAR BATTERY CHARGERS

- For lead-acid batteries up to 150Ah rating
- Rated output current:
 - 3A, 6A, 12A at 12VDC
 - 2.5A, 5A, 10A at 24VDC
- Electronic lock for shorted battery, reverse polarity, output overload and disconnected battery
- Output for alarm remote indication.

For lead-acid batteries. Modular version



BCF...

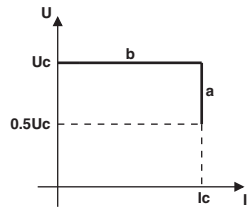

a - constant current charge
b - constant voltage charge

Order code	Rated output current	Rated output voltage in DC	Qty per pkg	Wt
	[A]	[V]	n°	[kg]
1 charging level.				
BCF025012	2.5	12	1	0.332
BCF045012	4.5		1	0.336
BCF012524	1.25	24	1	0.332
BCF025024	2.5		1	0.332

Alarms	VDC ON GREEN LED	BAT LOW RED LED	RELAY
Correct output voltage	ON	OFF	Energised
Reverse polarity	ON	ON	Energised
Short circuit/ Overload	OFF	OFF	De-energised

Type	Maximum power consumption		dissipation	Internal fuse mains side (Type T)
	[VA]	[W]	[W]	[A]
BCF025012	80	40	6	2ⓘ
BCF045012	150	70	9	2ⓘ
BCF012524	80	39	6	2ⓘ
BCF025024	150	77	9	2ⓘ

ⓘ Not replaceable.

General characteristics

- Switching technology
 - Wide auxiliary supply range
 - Screw fixing or 35mm DIN rail mount (IEC/EN/BS 60715).
- Protection:
- Mains input fuse
 - Battery output fuse
 - Electronic lock in case of short circuit on battery terminals, reverse battery polarity and output overload
 - Automatic reset at end of alarm conditions.

LED indications:

- Correct output voltage
- Reverse battery polarity.

Operational characteristics

- Auxiliary supply voltage: 100...240VAC $\pm 10\%$ 50/60Hz $\pm 5\%$
- Fixed charging current
- Current limitation
- Charging current according to DIN 41773 standards
- Fixed clamping screw terminal block with captive screws
- IEC degree of protection: IP20.

Alarm output circuit

- Type of output: 3A 250VAC AC1 duty relay, normally energised.

Certifications and compliance

Certifications obtained: EAC; UL Recognized for USA and Canada (cURus - File E360865), as Power Supplies - Component.

Products having this type of marking are intended for use as components of complete workshop-assembled equipment. Compliant with standards: IEC/EN/BS 62368-1, IEC/EN/BS 61000-6-2, IEC/EN/BS 61000-6-3, UL 60950-1, CSA C22.2 n°60950-1.

For lead-acid batteries



BCG...



BCGX00

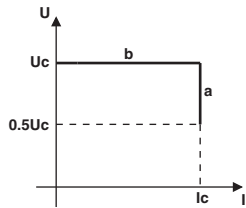

a - constant current charge
b - constant voltage charge

Order code	Rated output current	Rated output voltage in DC	Qty per pkg	Wt
	[A]	[V]	n°	[kg]
1 charging level.				
BCG0612	6	12	1	0.532
BCG1212	12		1	0.710
BCG0524	5	24	1	0.532
BCG1024	10		1	0.710
Accessories.				
BCGX00	Adapter for 35mm DIN rail vertical mount of BCG0612 and BCG0524		1	0.022

Alarms	ON GRN LED	REV RED LED	ALA RED LED	CHG YEL RED	RELAY
Correct output voltage	ON	OFF	OFF	OFF	Energ.
Charging	ON	OFF	OFF	ON①	Energ.
Low battery voltage	ON	OFF	ON	ON②	De-energ.
Reverse polarity	OFF	ON	OFF	OFF	De-energ.
Short circuit / Overload	ON	OFF	ON	OFF	De-energ.

① Steady light if the charging current is more than approx. 30% of programmed current value.

② Flashing during Hiccup operating conditions.

Type	Maximum power consumption			Internal fuse Mains side (type T)
	[VA]	[W]	[W]	[A]
BCG0612	230	97	14	4③
BCG1212	284	290	29	6.3
BCG0524	364	158	20	6.3③
BCG1024	630	311	41	8

③ Not replaceable.

General characteristics

- Switching technology
- Wide auxiliary supply range
- High efficiency
- Two charging voltages selectable by DIP-switch
- Boost external control for full battery charging
- Hiccup function for battery recharging when its voltage is lower than 50% rated value
- Charging current limiting trimmer resistor
- Screw fixing or 35mm DIN rail mount (IEC/EN/BS 60715).

Protection:

- Input fuse on AC side
- Electronic lock in case of short circuit on battery terminals, reverse battery polarity and output overload
- Automatic reset at end of alarm conditions.

LED indications:

- Power on
- Charging operation (>30% I_c)
- Overload or short circuit conditions
- Reverse battery polarity.

Operational characteristics

- Auxiliary supply voltage: 110...240VAC ±10% 50/60Hz ±10%
- Charging voltage selectable by DIP-switch
- Maximum charging current can be set with a trimmer on the front: 20...100% of the rated current value
- Current limitation
- Charging cycle according to DIN 41773 standards
- IEC degree of protection: IP20.

Alarm output circuit

- Type of output: 5A 30VDC duty relay, normally energised.

Certifications and compliance

Certifications obtained: EAC; UL Recognized for USA and Canada (cURus - File E360865), as Power Supplies - Component.

Products having this type of marking are intended for use as components of complete workshop-assembled equipment. Compliant with standards: IEC/EN/BS 62368-1, IEC/EN/BS 61000-6-2, IEC/EN/BS 61000-6-4, UL 60950-1, CSA C22.2 n°60950-1.

For lead-acid batteries



31BCE0312
31BCE2V524



31BCE0612
31BCE0524



31BCE1212
31BCE1024

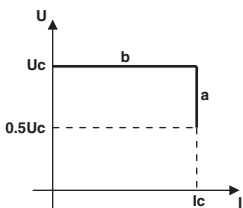

a - constant current charge
b - constant voltage charge

Order code	Rated output current	Rated output voltage in DC	Qty per pkg	Wt
	[A]	[V]	n°	[kg]
1 charging level.				
31BCE0312	3	12	1	1.984
31BCE0612	6		1	4.832
31BCE1212	12		1	8.690
31BCE2V524	2.5	24	1	1.992
31BCE0524	5		1	4.960
31BCE1024	10		1	9.560

Alarms	ON GREEN LED	ALARM RED LED	CHARGE GREEN LED	RELAY
Correct output voltage	ON	OFF	OFF	Energ.
Charging	ON	OFF	ON	Energ.
Low battery voltage	ON	ON	OFF	De-energ.
Reverse polarity	ON	ON	OFF	De-energ.
Short circuit / Overload	ON	ON	OFF	De-energ.
Battery disconnected	ON	ON	OFF	De-energ.

Type	Maximum power consumption	dissipation	Mains fuse (type)
	[VA]	[W]	[A]
BCE0312	117	24	1 (T) ext ❶
BCE0612	222	46	4 (F) int
BCE1212	400	73	6.3 (F) int
BCE2V524	166	26	1 (T) ext ❶
BCE0524	317	40	4 (F) int
BCE1024	610	66	6.3 (F) int

❶ Not supplied; installed by customer.

General characteristics

- Linear technology
- Housing for internal panel mounting by screws.
- Protection:
- Mains input fuse (except for BCE2V5 and BCE03)
- Battery output fuse
- Electronic lock in case of short circuit on battery terminals, reverse battery polarity, output overload (<0.5 Ue) and disconnected battery.

LED Indications:

- Power on
- Charge (I > 0.2 Ic)
- Alarm for protection tripping.

Operational characteristics

- Auxiliary supply voltage: 220...240VAC ±10%, 50/60Hz ±5%
- Charging current: 30...100% Ie adjustable
- Charging cycle according to DIN 41773 standards
- Current limitation
- Clamping screw terminal block with captive screws:
 - Removable for BCE03 and BCE2V5
 - Fixed for BCE05, BCE06, BCE10 and BCE12
- IEC degree of protection: IP00.

Alarms

Possible causes of alarm include:

- Low battery voltage
- Battery fuse blown
- Battery not connected
- Battery polarity inverted (reverse polarity).

BCE2V524 - BCE0312

These types have a static alarm output for the control of a relay or indicator, maximum 300mA duty. If it is connected to a relay, this must be normally energised in absence of alarm. In alarm conditions with ALARM LED switched on or in absence of supply, the relay de-energises.

BCE0524 - BCE0612 - BCE1024 - BCE1212

These types have a normally energised relay alarm output. In alarm conditions with ALARM LED switched on or in absence of supply, the relay de-energises.

Alarm output circuit

BCE2V524 - BCE0312

- Type of output:
 - Negative static; NPN transistor❷
 - Maximum voltage applicable to load: +V battery terminal
 - Maximum output current: 300mA
 - Maximum overload current for 1 second: 2A
 - Dynamic over-voltage protection with inductive load.

BCE0524 - BCE0612 - BCE1024 - BCE1212

- Type of output
 - Relay: 1 changeover contact (SPDT)
 - Rated voltage: 250VAC
 - IEC rated capacity in AC1 duty: 5A 250VAC Ith
 - IEC rated capacity in DC13 or DC14 duty: 5A 30VDC
 - Electrical life: >10⁵ cycles
 - Mechanical life: >30x10⁵ cycles.

❷ The output is not overload or short-circuit protected. It is however capable of switching on a 3W filament bulb.

Certifications and compliance

Certifications obtained: EAC.
Compliant with standards: IEC/EN/BS 60950-1.

DERATING CURVES

BCE2V524 - BCE0312

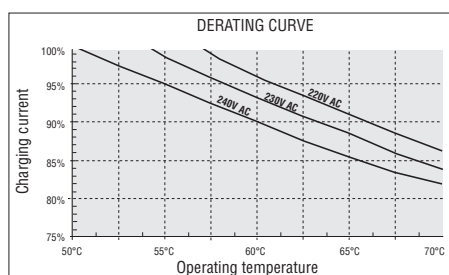

BCE0524 - BCE0612

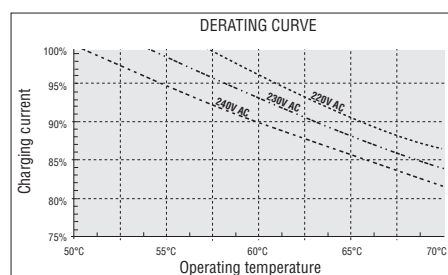

BCE1024 - BCE1212

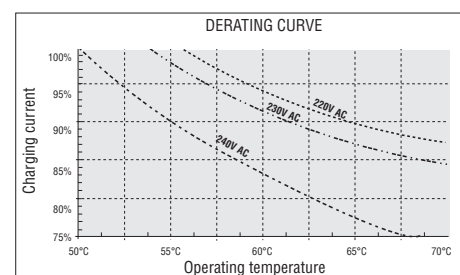

24 Automatic battery chargers

Dimensions [mm (in)]

BCF...

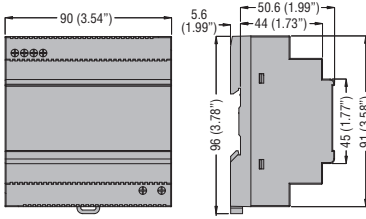

BCG0612 - BCG0524

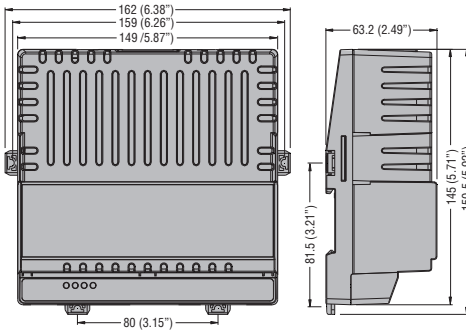

Mounting adapter BCGX00

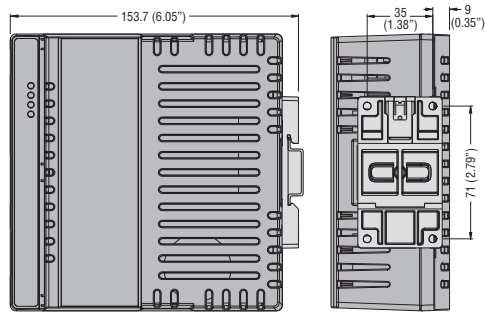

BCG1212 - BCG1024

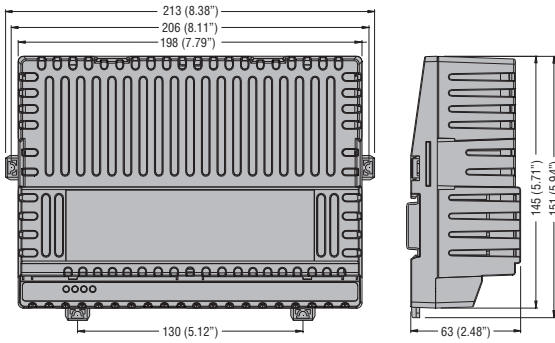

BCE0312 - BCE2V524

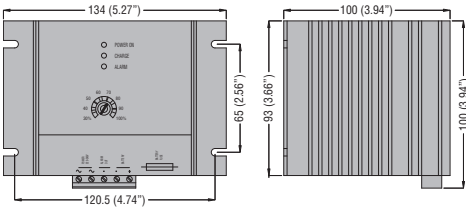

BCE0612 - BCE0524

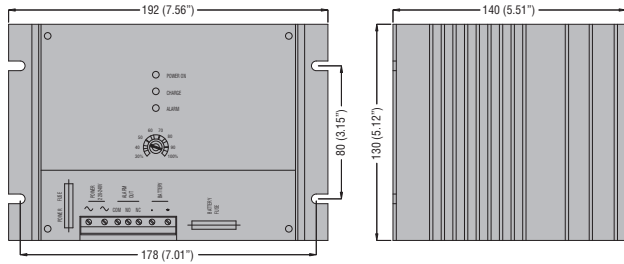

BCG1212 - BCE1024

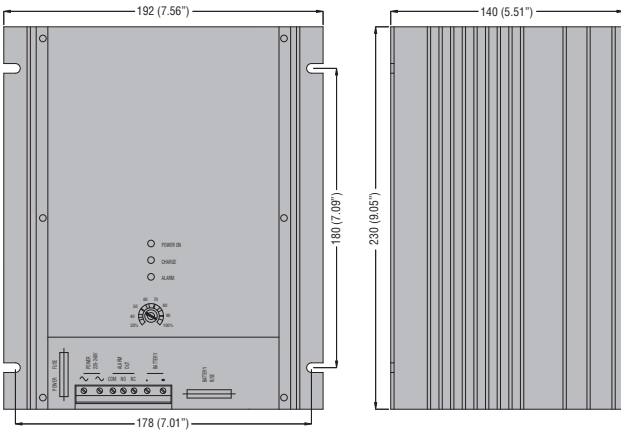

BCF...

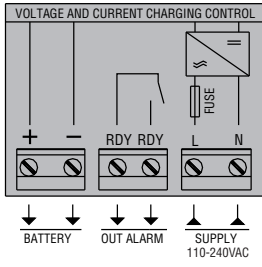

BCG...

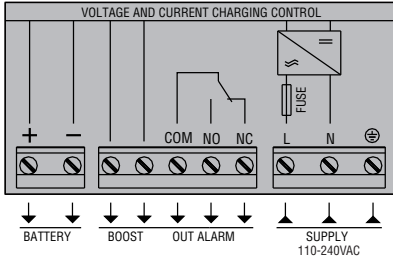

BCE2V5... - BCE03...

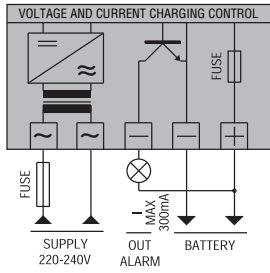

BCE05... - BCE06... - BCE10... - BCE12...

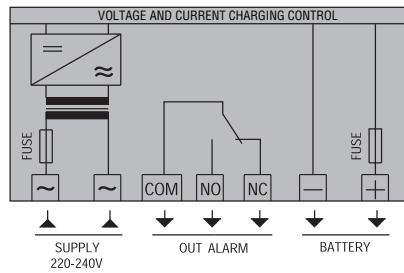

24 Automatic battery chargers

Technical characteristics

TYPE	BCF...	BCG...	BCE...
Description	Single phase automatic battery charger 1 charging level for lead-acid batteries	Single phase automatic battery charger 1 charging level for lead-acid batteries	Single phase automatic battery charger 1 charging level for lead-acid batteries
Supply voltage	100...240VAC ±10% 50/60Hz ±5%	110...240VAC ±10% 50/60Hz ±10%	220...240VAC ±10% 50/60Hz ±5%
Rated output voltage (Uoc)	12-24VDC		
Rated charging current (Ic)	2.5-4.5A (12VDC) 1.25-2.5A (24VDC)	6-12A (12VDC) 5-10A (24VDC)	3-6-12A (12VDC) 2.5-5-10A (24VDC)
CHARGING CYCLE			
Reference standards	DIN 41773		
Diagram	<p>a - constant current charge b - constant voltage charge</p>		
End charging voltage U _c	12V battery: 13.6VDC (2.27V/cell) 24V battery: 27.2VDC (2.27V/cell)	12V battery with DIP2: – in pos. V1: 13.8V – in pos. V2: 13.5V (default) 24V battery with DIP2: – in pos. V1: 27.6V – in pos. V2: 27.0V (default)	12V battery: 13.8VDC (2.3V/cell) 24V battery: 27.6VDC (2.3V/cell)
Charging current	Fixed	Adjustable 20% to 100% I _c (using potentiometer/trimpot)	Adjustable 30% to 100% I _c (using potentiometer)
Current limit	Yes		
Boost	—	+4.4% U _c	—
PROTECTION			
Type	<ul style="list-style-type: none"> – Mains supply fuse – Charging inhibition due to: <ul style="list-style-type: none"> • Short circuit at battery terminals • Reverse battery polarity • Low voltage at battery poles (<0.5 U_{oc}) • Output overload 	<ul style="list-style-type: none"> – Mains supply fuse – Charging inhibition due to: <ul style="list-style-type: none"> • Short circuit at battery terminals • Reverse battery polarity • Low voltage at battery poles (<0.5 U_{oc}) • Output overload 	<ul style="list-style-type: none"> – Mains supply fuse (5, 6, 10, 12A types only) – Battery output fuse – Charging inhibition due to: <ul style="list-style-type: none"> • Short circuit at battery terminals • Reverse battery polarity • Low voltage at battery poles (<0.5 U_{oc}) • Disconnected battery
ALARM OUTPUT CIRCUIT			
Type of output	1 relay 3A 250VAC AC1	1 relay 5A 30VDC	Static (NPN transistor) ①; relay with 1 c/o contact (SPDT), 5A 250VAC ②
AMBIENT CONDITIONS			
Operating temperature	-40...+51°C	-30...+55°C (+55...+70°C with 1-5%I _c /°C derating by trimpot)	-10...+50°C
Storage temperature	-40...+85°C	-30...+80°C	-30...+80°C
HOUSING			
Version	Modular	Internal panel mount	Internal panel mount
Mounting	35mm DIN rail (IEC/EN/BS 60715)	35mm DIN rail (IEC/EN/BS 60715) or screw fixing	Screw fixing
IEC degree of protection	IP20	IP20	IP00
Cooling	Natural		
Connections	Fixed terminals	Fixed terminals	Removable/plug-in terminals① Fixed terminals②

① For 2.5A and 3A types only.
② For 5, 6, 10 and 12A types only.



- Single and three-phase energy meters
- MID certified versions with UTF certificates
- cULus certified versions
- Power analyzer and multifunction digital metering instruments, expandable, with icon display, monochrome or colour
- Digital voltmeters, ammeters, wattmeters, frequency meters and $\cos\phi$ meters
- Connection to single, two and three-phase and for power monitoring systems
- Ideal for distribution systems, electricity cogeneration and within machinery installations
- High measurement accuracy
- Totally programmable digital and analog inputs and outputs
- RS485, RS232, USB, Ethernet, Profibus DP and M-Bus communication ports.

	SEC. - PAGE
Energy meters	
Single-phase.....	25 - 12
Single-phase, MID certified	25 - 13
Three-phase with or without neutral	25 - 14
Three-phase with neutral, MID certified	25 - 15
Three-phase with neutral, with UTF certificates	25 - 16
Data concentrator	25 - 18
Power analyzers and EASY BRANCH power monitoring system	
Power analyzer with widescreen colour LCD	25 - 19
EASY BRANCH power monitoring system	25 - 20
Multifunction digital metering instruments	
Modular LCD multimeters	25 - 21
Flush-mount LCD multimeters	25 - 23
Digital metering instruments	
Modular LED measuring instruments	25 - 24
Flush-mount LED measuring instruments	25 - 26
Communication devices, protection covers, accessories	25 - 29
Converter, gateway, connecting cables	25 - 30
Current transformers	25 - 31
Dimensions	25 - 36
Wiring diagrams	25 - 39
Technical characteristics	25 - 42



Page 25-12

ENERGY METERS

- Single-phase, three-phase with neutral, three-phase with or without neutral
- Direct connection or by current transformers
- MID or cULus certified versions
- Versions expandable with EXM... expansion modules
- Versions with built-in RS485 or M-Bus communication ports.



Page 25-18

DATA CONCENTRATORS

- Energy consumption data storage for network usage
- Connection up to 14 energy meters equipped with static output
- Expandable with EXM... expansion modules
- Built-in RS485 communication port.



Page 25-19

POWER ANALYZERS WITH WIDESCREEN COLOUR LCD

- Widescreen colour LCD display
- Flush-mount 92x92mm
- Versions with built-in RS485 communication port
- Versions with built-in Ethernet and data memory
- Versions expandable with EXP... expansion modules
- NFC and optical port
- Compatibility with EASY BRANCH power monitoring system.



Page 25-21

DIGITAL LCD MULTIMETERS AND POWER ANALYZERS

- Graphic or icon LCD
- Modular and flush-mount 92x92mm
- Versions expandable with EXM... and EXP... expansion modules
- Version with built-in RS485 communication port.
- Flush-mount version with current reading through Rogowski coils.



Page 25-24

LED MEASURING INSTRUMENTS

- Voltmeters, ammeters and wattmeters
- Modular and flush-mount 96x48mm versions.



Page 25-31

CURRENT TRANSFORMERS

- Primary current: 5...4000A
- Secondary current: 5A
- Solid and split-core types
- Instrument and accuracy versions.
- Wound primary CT for low currents
- Busbar versions.

SINGLE-PHASE DIRECT CONNECTION

Type	DMED100T1	DMED110T1	DMED111	DMED112	DMED115T1	DMED120T1	DMED121	DMED122	DMED130LM
Maximum current	40A	40A	40A	40A	40A	63A	63A	63A	63A
Display									
Vertical, no backlight	●	●	●	●					
Horizontal, backlight					●	●	●	●	●
Measurements									
kWh	●	●	●	●	●	●	●	●	●
kWh, kW with average and max demand		●	●	●	●	●	●	●	●
kvarh, kvar, V, I, Hz, PF, total and partial hour counter		●	●	●		●	●	●	●
Interface									
Pulse output	●								
Programmable output (pulses/thresholds)		●			●	●			
Built-in Modbus-RTU (RS485)			●				●		
Built-in M-Bus				●				●	
MID version -25...55°C ^①	●	●	●	●		●	●	●	
MID version -25...70°C ^②			●						
Load management									●
Compatibility with Synergy, Synergy _{can} and Xpress software			●				●		

THREE-PHASE

Type	DMED300T2	DMED301	DMED302	DMED305T2	DMED330	DMED332	DMED310T2
Maximum current	80A	80A	80A	CT /5 or CT /1	CT /5 or CT /1	CT /5 or CT /1	CT /5
Connection type							
Direct	●	●	●				
Via CT				●	●	●	●
Interface							
Programmable output (pulses/thresholds)	●			●			●
Built-in Modbus-RTU (RS485)		●			●		
Built-in M-Bus			●			●	
Expandability							
Communication (RS485, Ethernet, USB)							●
Relay outputs for load disconnection							●
Data memory (Data logger)							●
MID version -25...55°C ^{①④}	●	●	●	●	●	●	●
MID version -25...70°C ^②		●					
cULus version (ANSI C12.20) ^③	●	●					
Compatibility with Synergy, Synergy _{can} and Xpress software		●			●		●

① For MID versions add "MID"

② For MID7 versions add "MID7"

③ For UL versions add "UL"

④ UTF certified versions available on request.

DIN RAIL MOUNTING (MODULAR)

Type	DMG100	DMG110	DMG200	DMG210	DMG300
Maximum rated voltage	600VAC	600VAC	690VAC	690VAC	690VAC
Voltage and current measure accuracy	0.5%	0.5%	0.5%	0.5%	0.2%
Active energy measure accuracy	Class 1	Class 1	Class 1	Class 1	Class 0.5s
Single-phase energy meter	●	●			
Harmonic analysis	15 th order	15 th order	THD only	THD only	31 st order
Boolean logic					●
Expandable with EXM... modules					3 modules
Display type	Icons	Icons	Graphic	Graphic	Graphic
Built-in communication port		RS485		RS485	
Communication port with EXM... modules					RS232 USB RS485 Ethernet
Ethernet-RS485 gateway function					●

FLUSH MOUNTING

Type	DMG600	DMG610	DMG611	DMG615	DMG620	DMG7000	DMG7500	DMG8000	DMG9000
Maximum rated voltage	600VAC	600VAC	600VAC	600VAC	600VAC	600VAC	600VAC	600VAC	600VAC
Current reading	CT /5A or CT /1A	CT /5A or CT /1A	Rogowski coils	CT /5A or CT /1A	CT /5A or CT /1A	CT /5A or CT /1A	CT /5A or CT /1A	CT /5A or CT /1A	CT /5A or CT /1A
Voltage and current measure accuracy	0.5%	0.5%	0.5%	0.2%	0.2%	0.2%	0.2%	0.2%	0.2%
Active energy measure accuracy	Class 1	Class 1	Class 1	Class 0.5s	Class 0.5s	Class 0.5s	Class 0.5s	Class 0.5s	Class 0.5s
Single-phase energy meter	●	●	●	●	●	●	●	●	●
Harmonic analysis	15 th order	15 th order	15 th order	15 th order	15 th order	63 rd order	63 rd order	63 rd order	63 rd order
Neutral-earth voltage									●
Neutral current	Calculated	Calculated	Calculated	Calculated	Calculated	Calculated	Calculated	Calculated	Measured
PLC logic						●	●	●	●
Display type	Icons	Icons	Icons	Icons	Icons	Colour graphic	Colour graphic	Colour graphic	Colour graphic
Built-in communication port		RS485	RS485	RS485	Ethernet		RS485	Ethernet	RS485 Ethernet
Expandable with EXP... modules	1 module	1 module	1 module	1 module	1 module	3 modules	3 modules	3 modules	3 modules
Communication port with EXP... modules	RS232 USB RS485 Ethernet	RS232 USB RS485 Ethernet	RS232 USB RS485 Ethernet	RS232 USB RS485 Ethernet	RS232 USB RS485 Ethernet	RS232 USB RS485 Ethernet Profibus DP	RS232 USB RS485 Ethernet Profibus DP	RS232 USB RS485 Ethernet Profibus DP	RS232 USB RS485 Ethernet Profibus DP
Data memory								●	●
Ethernet-RS485 gateway function						●	●	●	●
Energy quality according to EN 50160									●
Compatibility with EASY BRANCH power monitoring system							●	●	●
Degree of protection	IP54	IP54	IP54	IP54	IP54	IP65	IP65	IP65	IP65

● Coils and calibration report included.

POWER ANALYZERS WITH WIDESCREEN COLOUR LCD DMG SERIES



WIDESCREEN COLOR LCD
The large size of the colour LCD (4.3") allows for the optimal view of measures and parameters in a clear, simple and intuitive way.
The standard cutout dimensions (92x92mm) ensures a perfect compatibility with the usual front panel solutions.



10 LANGUAGES
The language shown can be selected from a large number of choices: English, French, German, Italian, Spanish, Portuguese, Polish, Russian, Czech, Chinese.

PROGRAMMABLE LEDs
3 front LEDs are programmable and let the user know the status of the device at any time: alarms programmed by the user, status of digital inputs or outputs, emission of pulses indicating energy consumption, communication in progress.



HIGH ACCURACY LEVEL FOR MEASUREMENTS
The measurements are verified according to the recognized international standards for measuring instruments: IEC 62053-22 (class 0.5s), IEC 62053-24 (class 1) and IEC 61557-12 (class 0.5).

NFC CONFIGURATION
Thanks to NFC technology, it is possible to configure and modify parameters (even when the device is not powered) through **NFC LOVATO** App, which can be downloaded for free from the Google Play Store and App Store for Android and iOS smart devices.



PLC LOGIC
Thanks to the built-in PLC logic, the power analyzers can perform simple automations related to timers and alarm states and digital inputs. Programming with "contacts" (**Ladder**) is simple and intuitive thanks to the use of **Xpress** configuration software.

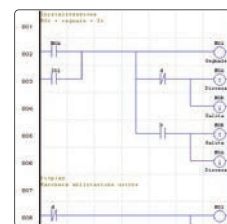

	DMG7000	DMG7500	DMG8000	DMG9000
Built-in RS485 port	-	●	-	●
Built-in Ethernet port (with web-server)	-	-	●	●
Ethernet-RS485 gateway function	+ EXP1012 + EXP1013	+ EXP1013	+ EXP1012	●
Memory for data collection	-	-	●	●
Statistics of network quality according to EN50160	-	-	-	●
Neutral current measurement through dedicated CT	-	-	-	●
Neutral-Earth voltage measurement	-	-	-	●
Compatibility with EASY BRANCH power monitoring system	-	●	●	●

EVERYTHING UNDER CONTROL!

MEASUREMENTS
DMG power analyzers display all the measurements useful for a complete check of the electrical network. The voltage measurement input does not require external transformers **up to 600VAC**.

CHARTS AND HARMONICS
The electrical measurements are shown with waveform charts, polar diagrams and representations of the **harmonic spectrum up to the 63rd order** which is a useful tool to better understand the state of the system.

STATISTICS
The DMG9000 model also provides statistics on the quality of the network according to the **EN50160** standard - class C - (voltage dips, overvoltages, interruptions, low frequency noises and much more).

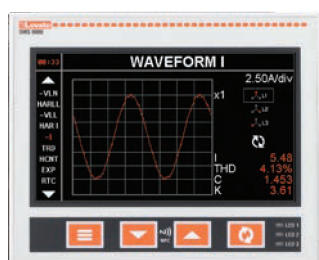

Waveforms



Polar diagram



Currents

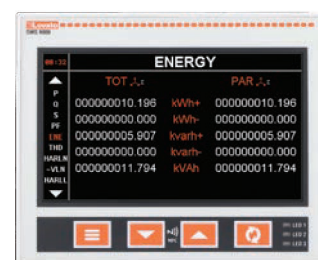

Energy consumption control

EXPANDABILITY AND COMMUNICATION

● **EXPANDABILITY**

Possibility to add **up to 3** EXP... series expansion modules (additional inputs, outputs and communication ports).

● **INTEGRATION WITH SIGNALS FROM THE FIELD**

Thanks to the EXP... expansion modules it is possible to add **digital and analog inputs** by which field measurements such as gas or water consumption, tank levels, temperatures, pressures and much more are integrated into the data collection in order to obtain a complete energy management.

● **OPTICAL PORT**

The optical port compatible with the communication devices CX01 and CX02 is available and allows, thanks to **Xpress** software, the parameter configuration, the electrical network diagnostics and the firmware update of the power analyzer.

● **DEGREE OF PROTECTION: IP65**

Possibility of use in harsh environments thanks to the gasket on the back which guarantees the **IP65** degree of protection.

● **COMMUNICATION**

Availability of models with built-in **RS485** and **Ethernet** communication ports.

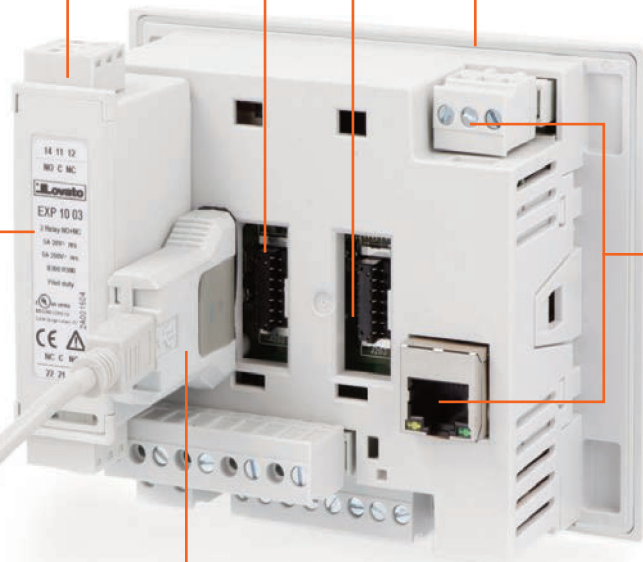

● **EASY BRANCH POWER MONITORING SYSTEM**

Thanks to the EXS... modules, a simplified and very fast wiring can be achieved in panels where it is necessary to read the electrical parameters of different loads, drastically reducing the costs and the installation times.



WEB-SERVER FUNCTION IN DMG8000 AND DMG9000



● **SETTING OF ALL PARAMETERS**

The programming of the parameters, as well as from the front panel, can also be done through the browser on a PC. The built-in web-server also allows the setting of the parameters of the EASY BRANCH power monitoring system, such as the descriptions of the individual measurement points.

● **WEBSERVER AND BUILT-IN DATA MEMORY**

A flash data memory allows archiving of historical data. Through the built-in webserver the user can:

- select the measures (up to 128);
- set the sampling frequency;
- download the .CSV file with the acquired informations.

For example, by sampling 20 measurements with 1 minute of sampling time, 10 days of data can be stored.

● **MEASUREMENT VIEW**

Representation of the measured values by means of tables and charts.

EASY BRANCH POWER MONITORING SYSTEM

When inside an electrical panel the parameters of several loads have to be monitored, **EASY BRANCH** power monitoring system is a more efficient and simple alternative solution to install than the traditional one which requires an independent instrument for each measuring point. The electrical distribution panels in shopping centres or in the departments of a production facility represent ideal applications for **EASY BRANCH** system by LOVATO Electric.

SYSTEM COMPONENTS



DMG7500 - 8000 - 9000
Power analyzer

● **DMG7500, DMG8000, DMG9000 power analyzers.**

The power analyzers represent the heart of the system: they measure the electrical voltage in the switchboard and the input current, record the total measurements upstream of the distribution and the measurements of each individual monitored load available on their display. The electrical quantities can also be viewed via the built-in communication ports (RS485 or Ethernet).



On the **DMG8000** and **DMG9000** models, the system measurements can be viewed within a web page and can be recorded in the data memory to get historical trends.



EXS0000
Bus module

● **EXS0000 bus module**

Installed in one of the expansion slots of the power analyzer, by using a standard Ethernet cable (cat.6) it connects and supplies **up to 8 current measuring modules EXS4...** which are automatically recognized without the need for settings by the installer.

When connecting 5 or more EXS4 current modules ... the **EXS0000** bus module requires a 24VDC - 0.2A power supply.

MAX 8 EXS4... current measuring modules can be connected to the EXS0000 bus module, to monitor up to:

- 33 three-phase loads;
 - 99 single phase loads.
- Including the loads connected to the power analyzer.

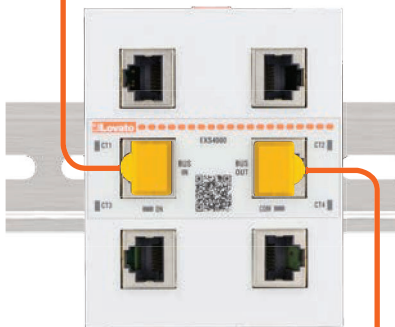

EXS4000
Current measuring module with 4 inputs for electronic RJ45 CTs

● **Current measuring module EXS4000**

The module collects the measurements of the loads monitored by the electronic current transformers EXS3... (three-phase or single-phase) or EXS1... (single-phase). Each module measures **up to 4 three-phase loads or 12 single-phase loads** or a mixed single-phase and three-phase configuration. The module automatically recognizes the connected electronic current transformer and highlights, through diagnostic LEDs, the correct self-configuration of the measurement points and the correct coupling with the power analyzer.

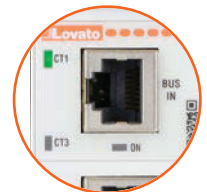

Correct self-configuration LED

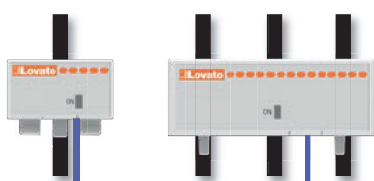

EXS1... - EXS3...
Electronic current transformer

● **Electronic current transformers EXS1... and EXS3...**

They are current transducers suitable to be installed immediately downstream of the magnetic circuit breakers thanks to their compact size. Available **for single-phase or three-phase loads**, the diameter and pitch of the pass-through holes have been designed to be in line with the ones of the MCBs:

- for sizes up to 63A: $\varnothing = 7\text{mm}$ and 18mm pitch;
- for sizes up to 125A: $\varnothing = 12\text{mm}$ and 27mm pitch.

They connect to the EXS4000 current monitoring module via pre-wired **2 meter RJ45 cable**, thus making the connection fast and fail-safe.

EXS3 ... can be programmed to manage even single-phase loads.



Correct coupling signalling LED



2m pre-wired cable

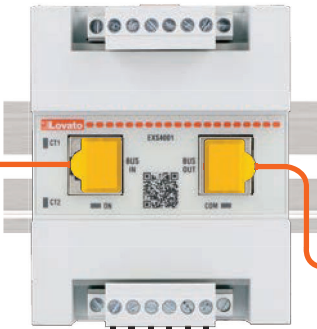

● **Current measuring module EXS4001**

It offers the possibility of connecting monitored measuring points with traditional current transformers within the EASY BRANCH system, managing for each module **up to 2 three-phase loads or 6 single-phase loads** or a mixed single-phase and three-phase configuration. Current transformers of any type with secondary /5A or /1A can be used. The module highlights the successful coupling with the power analyzer through diagnostic LEDs.



Correct coupling signalling LED

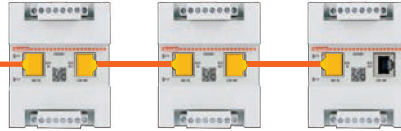

EXS4001

Current measuring module with 2 inputs for three-phase traditional CTs or 6 inputs for single-phase traditional CTs

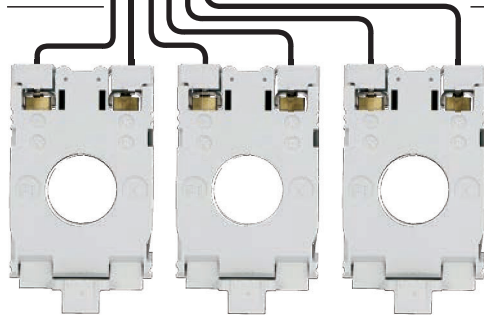

DM...

Current transformers

● **Traditional current transformer DM...**

Current transformers (CTs) type DM... are mounted in an electrical system to reduce the line current to a secondary value of 5A and compatible with EXS4001 current measuring modules.

They are available in many versions:

- with wire-wound primary for reduced currents;
- solid core type;
- high precision for very accurate measurements;
- split-core and pre-wired types which are suitable for updating the panels;
- **primary current from 5 to 4000A.**

● **Gateway data logger**

A gateway data logger is the key device for the implementation of a modern and well-designed energy monitoring system.

It collects data from LOVATO Electric devices or from environmental sensors relating to any type of energy carrier (water, air, gas, electricity and steam) equipped with a compatible protocol.

The data collected, as well as being represented by the integrated web-server, can be transmitted to **Synergy** supervision software of LOVATO Electric or forwarded to remote servers in formats suitable for appropriate processing.



EXCGLA01

Gateway data logger

● **Supervision software**

All the data of the EASY BRANCH system are available on the central power analyzer and, through its communication ports, it is possible to collect them remotely by connecting directly with a browser if the model chosen is DMG8000 or DMG9000, or through **Synergy** software installed on a local server, or using **Synergy** Cloud if the gateway data logger EXCGLA01 is added to the system.



SYNERGY

Supervision software

EASY BRANCH PLUG & PLAY SYSTEM ADVANTAGES

● **4 COMPONENTS NEEDED**

The EASY BRANCH system consists of a few elements to add to the power analyzer: EXS0000 module to get the communication bus, the EXS4... module to measure currents and the EXS1..., EXS3 electronic current transformers... or traditional /5A or /1A CTs.

Up to 33 three-phase or 99 single-phase measuring points can be obtained!

● **DRAMATIC REDUCTION OF WIRING TIMES**

In a monitoring system with traditional measuring instruments, 4 voltage and 6 current cables are required for each three-phase measuring point and two additional cables for the auxiliary power supply are added: a total of 12 cables to be connected for each measuring point.

With the EASY BRANCH system, for each additional current measuring module (EXS4000) only one cable with **RJ45** terminal must be connected, getting 4 three-phase or 12 single-phase measurement points, each of which is connected with a cable with RJ45 terminal, drastically reducing the wiring time.

● **STOP TO WIRING MISTAKES!**

In a monitoring system with traditional measuring instruments, 12 cables to be connected for each three-phase measuring point can cause various wiring errors (phase sequence, phase correspondence between voltages and currents, current transformers sense) which cause errors in reading the electrical quantities and delay the commissioning of the switchboard.

The EASY BRANCH system, thanks to the **RJ45** connections of the electronic CTs, is foolproof!



● **SETTING TIME REDUCTION**

EXS1... and EXS3... electronic transformers have a **self-recognition** system with the current module to which they are connected, avoiding the installer the need to set the CT primary and the type of connection (single-phase, three-phase). A LED on the electronic transformers indicates the correct power supply, while a LED on EXS4000 current measuring module indicates the correct coupling.

● **NO SPECIAL CABLES NEEDED**

No special cable is needed to connect the current measuring modules to EASY BRANCH bus: **a standard Cat.6 Ethernet cable is enough.**

● **COMPARISON BETWEEN EASY BRANCH AND TRADITIONAL MEASURING SYSTEMS**

If 5 three-phase loads are to be monitored in an electrical panel:

- **EASY BRANCH SYSTEM:** 1 power analyzer, 1 display where to search for measurements, 1 EXS0000 bus module, 1 EXS4000 current measuring module, 4 three-phase electronic transformers and only 12 cables to be wired
- **TRADITIONAL SYSTEM:** 5 multimeters, 5 displays where to search for measurements, 15 current transformers and 60 cables to be wired.

The more the measuring points increase, the more the advantages in favour of the EASY BRANCH system are evident.

● **MEASUREMENT ACCURACY**

The EASY BRANCH system guarantees high measurement accuracy according to IEC61557-12 and IEC62053-22/23 standards.

PLANT MANAGEMENT WITH EASY BRANCH

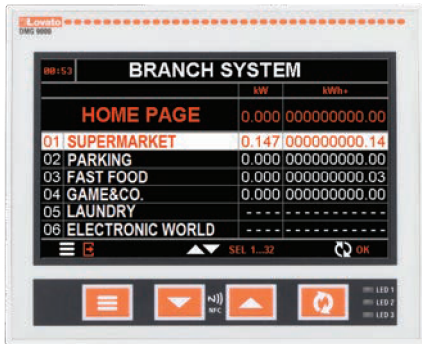

DMG7500 - 8000 - 9000
Power analyzer



EXS0000
Bus module for EASY BRANCH system

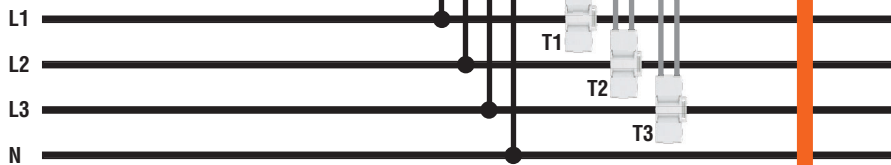

EXS1080
80A single-phase electronic current transformer with RJ45 cable, 2m long

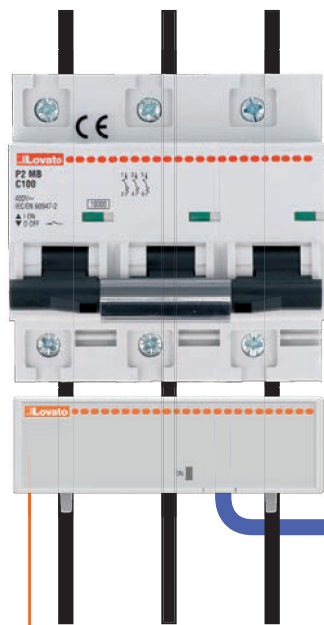

EXS3125
125A three-phase electronic current transformer with RJ45 cable, 2m long

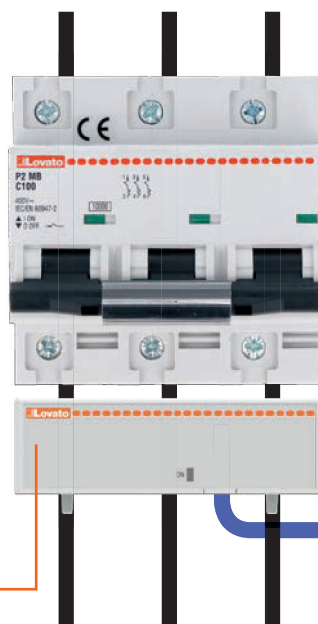

EXS3080
125A three-phase electronic current transformer with RJ45 cable, 2m long

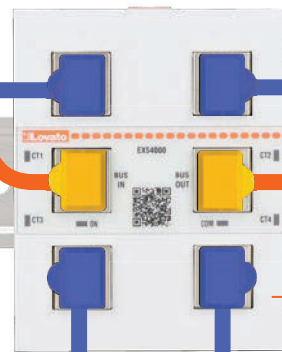

EXS4000
Current measuring module with 4 inputs for electronic RJ45 CTs



EXS3063
63A three-phase electronic current transformer with RJ45 cable, 2m long

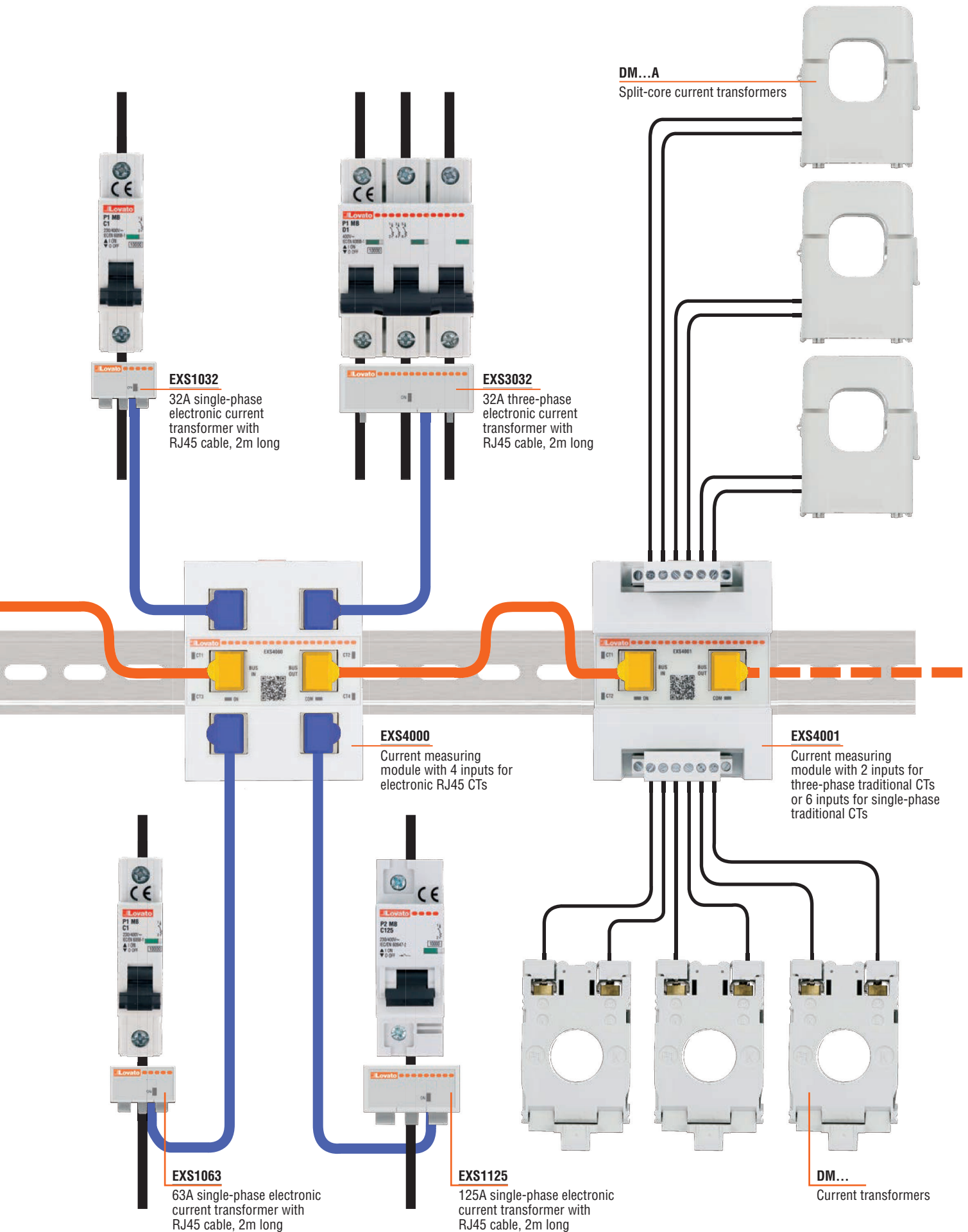

ENERGY MANAGEMENT SOLUTION BY LOVATO ELECTRIC

For the purpose of monitoring and energy saving, LOVATO Electric provides a complete and integrated solution consisting of:

- **hardware devices** for energy measurement and control (power analyzers, multimeters, energy meters, variable speed drives, soft starters, automatic power factor controllers, gateway data loggers, etc.);
- webserver **software** to continuously monitor energy vectors via the Web.

Synergy by LOVATO Electric is an energy monitoring and analysis system with a professional, flexible and integrated approach from an Industry 4.0 perspective. Thanks to the LOVATO Electric **measurement devices** equipped with a communication port and through the web-based supervision platform, it is possible to monitor real time measurements, consult graphics, receive alarms, export customized reports and carry out commands and settings.

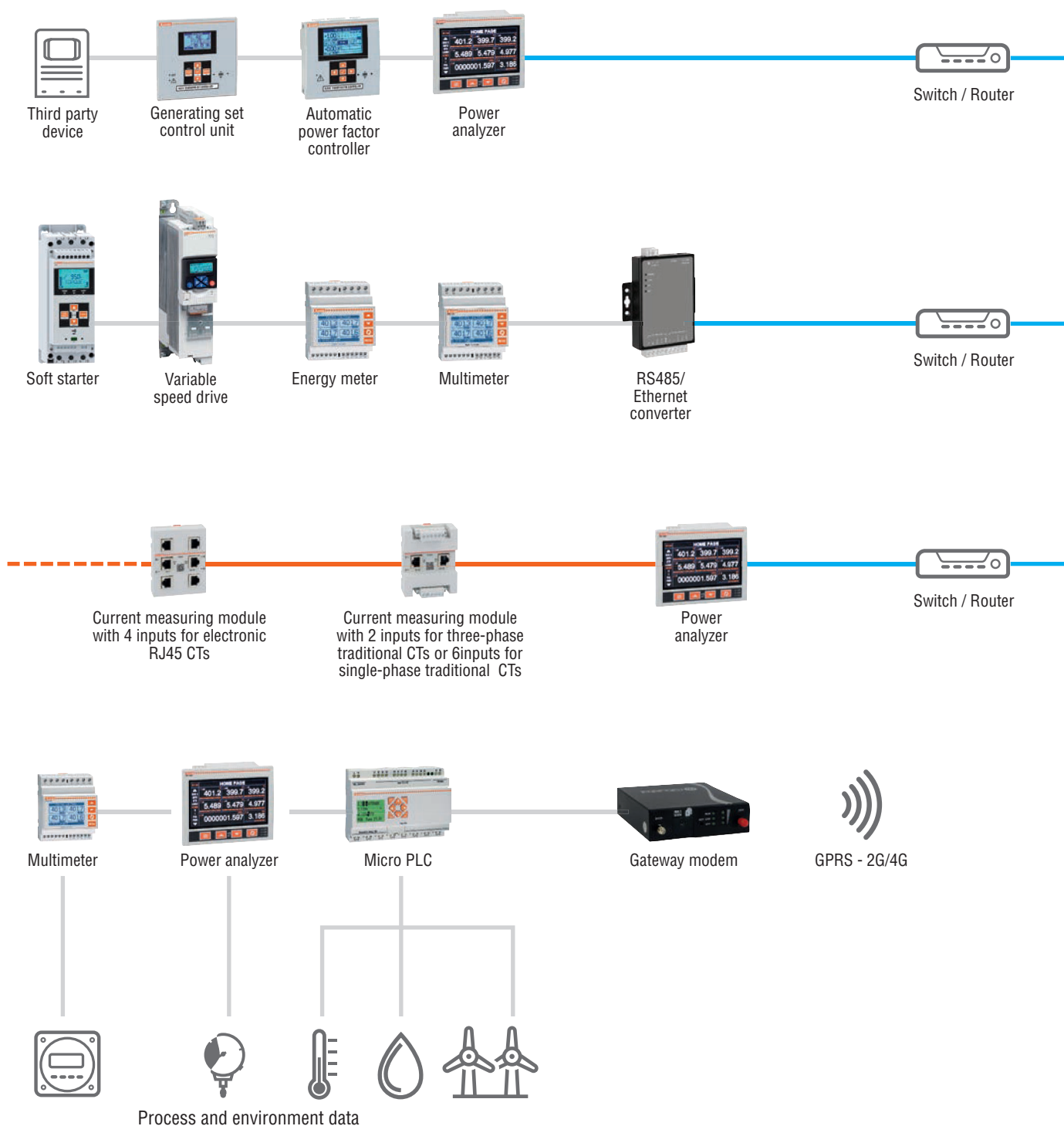

GATEWAY DATA LOGGER LOCAL WEBSERVER

LOVATO Electric **EXCGLA01** gateway data logger provides access to an integrated webservice which allows local consultation of the monitored data and acts as a gateway to **Synergy** supervision software.



Gateway data logger

Built-in webservice information view



Pre-defined live pages, charts and data logs

MONITORING AND SUPERVISION SOFTWARE



Synergy is a software which can be completely customized by the user who can thus have the key indicators of the monitored systems, be notified in the event of alarms for anomalies in consumption and monitor performance over time. It is open to the integration of third-party instrumentation thanks to the use of the MODBUS communication protocol and the ability to integrate any device equipped with analog or digital output.

Multi-device



Laptop



Tablet



Smartphone

Multi-users



Administrators



Powerusers



Users



Customizable Dashboard, Data Log and Reports

Single-phase



DMED110T1...
DMED110T1A120
DMED111
DMED112

new



DMED115T1...
DMED120T1...
DMED121 - DMED122

Order code	Description	Qty per pkg	Wt
		n°	[kg]
Digital meter, with LCD screen.			
DMED100T1	40A direct connection, 1U 1 pulse output, 220...240VAC	1	0.086
DMED100T1A120	40A direct connection, 1U 1 pulse output, 110...120VAC	1	0.086
DMED110T1	40A direct connection, 1U 1 program. static output, multi-measurements①, 220...240VAC	1	0.090
DMED110T1A120	40A direct connection, 1U 1 program. static output, multi-measurements①, 110...120VAC	1	0.090
DMED111	40A direct connection, 1U, RS485 interface multi-measurements①, 110...240VAC	1	0.090
DMED112	40A direct connection, 1U, M-Bus interface multi-measurements①, 110...240VAC	1	0.090
Digital meter with backlight LCD display.			
DMED115T1	40A direct connection, 2U, 1 program. static output, multi-measurements ②, 220-240VAC	1	0.090
DMED120T1	63A direct connection, 2U 1 program. static output, multi-measurements ①, 220-240VAC	1	0.148
DMED120T1A120	63A direct connection, 2U 1 program. static output, multi-measurements①, 110...120VAC	1	0.148
DMED121	63A direct connection, 2U, RS485 interface multi-measurements①, 110...240VAC	1	0.148
DMED122	63A direct connection, 2U, M-Bus interface multi-measurements①, 110...240VAC	1	0.148

Order code	Description	Qty per pkg	Wt
		n°	[kg]
Digital meter with backlight LCD display per load management.			
DMED130LM	63A direct connection, 4U, multi-measurement①, 2 inputs and 2 relay outputs for load management, 220...240VAC	1	0.300

Single-phase Load management



DMED130LM

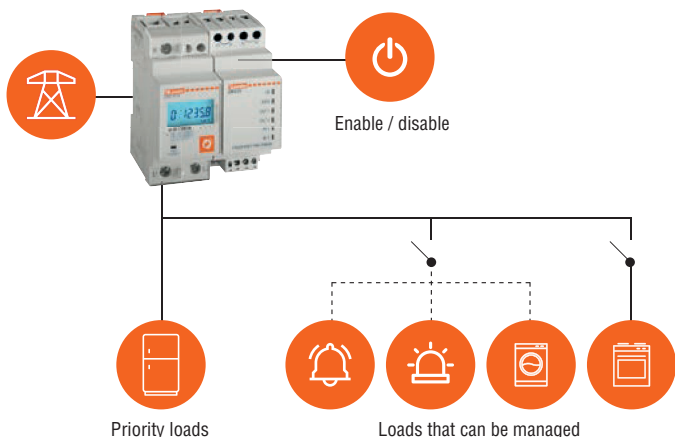

General characteristics

The energy meters are instruments for energy consumption measurement in single-phase installations with direct connection.

Operational characteristics

- LCD meter: with 5+1 digit count for DMED100T1..., DMED110T1..., DMED111, DMED112; backlight with 6+1 digit count for DMED115T1, DMED120T1..., DMED121, DMED122, DMED130LM
- Direct connection
- Active energy measurement and accuracy: Class 1 (IEC/EN/BS 62053-21)
- Reactive energy measurement and accuracy: Class 2 (IEC/EN/BS 62053-23)
- Metrological LED with pulse emission for consumption indication
- Clearable partial energy measurement
- Built-in RS485 or M-Bus ports for pulse output models (except DMED130LM) compatible with **Synergy** and **Xpress**
- Modular housing: 1 module for DMED100T1, DMED110T1, DMED111 and DMED112; 2 module for all other types
- Sealable terminal blocks, standard supplied
- EN degree of protection: IP40 on front; IP20 at terminals.

Synergy supervision and energy management software
See Section 30.

Xpress configuration and remote control software
See Section 30.

EXM series expansion modules
See page 31-3.

Certifications and compliance

Certifications obtained: cULus (DMED100..., DMED110..., DMED120..., DMED121), EAC (for all DMED... type), RCM (for all DMED...type, DMED122 except).
Compliant with standards: IEC/EN/BS 50470-1, IEC/EN/BS 61010-1 per tipi DMED....; UL 61010-1, CSA C22-2 n° 61010-1 for DMED100..., DMED110..., DMED120..., DMED121.

① Multi-measurements:

- Total and partial active energy
- Total and partial reactive energy
- Voltage
- Current
- Active and reactive power
- Power factor
- Frequency
- Total and partial hour counter
- Average active power (calculation made using the last 15 minutes of data)
- Maximum demand.

② Multi-measurements:

- Total and partial active energy
- Active power
- Average active power (calculation made using the last 15 minutes of data)
- Maximum demand.

Single-phase, MID certified

MID



DMED110T1MID
DMED111MID
DMED112MID



DMED111MID7



DMED120T1MID
DMED121MID
DMED122MID

new

Order code	Description	Qty per pkg	Wt
		n°	[kg]
Digital meter with LCD display.			
DMED100T1MID	40A direct connection, 1U 1 pulse output, 230VAC	1	0.090
DMED110T1MID	40A direct connection, 1U 1 programmable static output, multi-measurements ①, 230VAC	1	0.090
DMED111MID	40A direct connection, 1U, RS485 interface, measurements ①, 230VAC	1	0.090
DMED111MID7	40A direct connection, 1U, RS485 interface, measurements ①, 230VAC, -25...+70°C	1	0.090
DMED112MID	40A direct connection, 1U, M-Bus interface, measurements ①, 230VAC	1	0.090
DMED120T1MID	63A direct connection, 2U 1 programmable static output, multi-measurements ①, 230VAC	1	0.152
DMED121MID	63A direct connection, 2U, RS485 interface multi-measurements ①, 230VAC	1	0.148
DMED122MID	63A direct connection, 2U, M-Bus interface multi-measurements ①, 230VAC	1	0.148

General characteristics

The DME... series energy meters, MID certified, are needed for billing purposes between electricity suppliers and consumers and for energy consumption measurement in directly connected single-phase installations. MID is the Measuring Instruments Directive of the European Union; instruments must be certified accordingly whenever used for monetary transactions in this territory.

Operational characteristics

- LCD meter: DMED100/110/111/112T1MID; backlight with 6+1 digit count for DMED120/121/122MID
- Direct connection
- Active energy measurement and accuracy: Class B (EN 50470-3)
- Reactive energy measurement and accuracy: Class 2 (IEC/EN/BS 62053-23)
- Metrological LED with pulse emission for consumption indication
- Clearable partial energy measurements
- One output: pulse for DMED100T1MID; programmable static for other types
- Built-in RS485 or M-Bus ports for pulse output models compatible with Synergy and Xpress
- 70°C model ideal for electric vehicle charging stations
- Modular housing
- Sealable terminal blocks, standard supplied
- EN degree of protection: IP40 on front; IP20 at terminals.

Synergy supervision and energy management software
See Section 30.

Xpress configuration and remote control software
See Section 30.

EXM series expansion modules
See page 31-3.

Certifications and compliance

Certifications obtained: MID Class B (EN 50470-1, EN 50470-3), certifications per module B (type tests) + module D (production conformity).
Compliant with standards: EN 50470-1, EN 50470-3, TR50579.

- ① Multi-measurements:
 - Total and partial active energy
 - Total and partial reactive energy
 - Voltage
 - Current
 - Active and reactive power
 - Power factor
 - Frequency
 - Total and partial hour counter
 - Average active power (calculation made using the last 15 minutes of data)
 - Maximum demand.

Three-phase with or without neutral, non expandable



DMED300T2
DMED301
DMED302

new



DMED305T2
DMED330
DMED332

new

Three-phase with or without neutral, expandable



DMED310T2



EXM1010

Order code	Description	Qty per pkg	Wt
		n°	[kg]

Digital meter for three-phase with neutral. 80A direct connection.

DMED300T2	2 programmable static outputs, multi-measurements ^① , 4U	1	0.360
DMED300T2UL	2 programmable static outputs, multi-measurements ^① , cULus certified, 4U	1	0.360
DMED301	4U, RS485 interface, multi-measurements ^① , 4U	1	0.360
DMED301UL	RS485 interface, multi-measurements ^① , cULus certified, 4U	1	0.360
DMED302	4M-Bus interface, multi-measurements ^① , 4U	1	0.360

Digital meter for three-phase with or without neutral. Connection by CT /5A.

DMED305T2	2 programmable static outputs, multi-measurements ^① , 4U	1	0.332
DMED330	RS485 interface, multi-measurements ^① , 4U	1	0.332
DMED332	M-Bus interface, multi-measurements ^① , 4U	1	0.332

Order code	Description	Qty per pkg	Wt
		n°	[kg]

Digital meter for three-phase with or without neutral. Connection by CT /5A.

DMED310T2	4U, 2 programmable static outputs, multi-measurements ^① , expandable with EXM... modules series, 4U	1	0.332
------------------	--	---	-------

Order code	Description
------------	-------------

DMED310T2 EXPANSION MODULES.
Inputs and outputs.

EXM1000	2 digital inputs and 2 static outputs, opto-isolated
EXM1001	2 opto-isolated digital inputs and 2 relay outputs rated 5A 250VAC

Communication ports.

EXM1010	Opto-isolated USB interface
EXM1011	Opto-isolated RS232 interface
EXM1012	Opto-isolated RS485 interface
EXM1013	Opto-isolated Ethernet interface
EXM1020	Opto-isolated RS485 interface and 2 relay outputs rated 5A 250VAC
EXM1030	Data storage, clock-calendar (RTC) with backup reserve energy for data logging

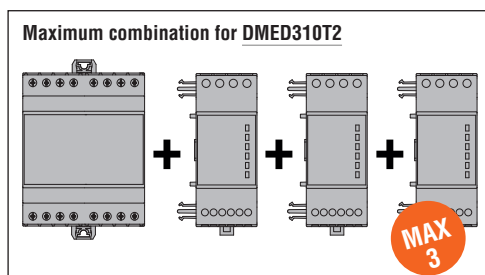

General characteristics

The energy meters are digital meters/analyzers of electric energy for systems with direct three-phase connection or by CT.

Operational characteristics

- LCD multifunction meter
- Nominal supply voltage: 380...415VAC (L-L); UL nominal supply voltage: 120VAC (L-N), 240VAC (L-L), 60Hz, direct two-phase + N
- Active energy measurement and accuracy: Class 0.5s (IEC/EN/BS 62053-22) for DMED305T2, DMED330 and DMED332; Class 1^② (IEC/EN/BS 62053-21) for DMED300T2, DMED301 and DMED302; Class 0.5 (ANSI C12.20) for DME3...UL
- Active energy measurement and accuracy: Class 2 (IEC/EN/BS 62053-23)
- Metrological LED with pulse emission for consumption indication
- Clearable partial active energy measurements
- 1 programmable digital input
- 2 programmable static outputs for DMED300T2, DMED305T2 and DMED310T2
- Built-in RS485 or M-Bus ports for pulse output models compatible with Synergy and Xpress
- Optical interface for EXM... expansion modules with DMED310T2
- Modular housing, 4 module
- Sealable terminal blocks, standard supplied
- EN degree of protection: IP40 on front; IP20 at terminals.

Synergy supervision and energy management software
See Section 30.

Xpress configuration and remote control software
See Section 30.

EXM series expansion modules
See page 31-3.

Certifications and compliance

Certifications obtained: EAC, RCM for all types, cULus for DMED...UL.
Compliant with standards: IEC/EN/BS 50470-1, IEC/EN/BS 61010-1, IEC 61010-2-030.

① Multi-measurements:

- Total and partial active energy
- Total and partial reactive energy
- Voltage
- Current
- Active and reactive power
- Power factor
- Frequency
- Total and partial hour counter
- Average active power (calculation made using the last 15 minutes of data)
- Maximum demand.

② Class 1 according to IEC/EN/BS 62053-21, accuracy measured in the 0.75A-80A range: 0.5%

Energy meters
MID certified

Three-phase with neutral, non expandable, MID certified

MID



DMED300T2MID
DMED301MID
DMED301MID7
DMED302MID

new



-25...+70°C



DMED305T2MID
DMED330MID
DMED332MID

Three-phase with neutral, expandable, MID certified

MID



DMED310T2MID



EXM1010

Order code	Description	Qty per pkg	Wt
		n°	[kg]

Digital meter for three-phase with neutral. 80A direct connection.

DMED300T2MID	2 programmable static outputs, multi-measurements❶, 4U	1	0.360
DMED301MID	RS485 interface, multi-measurements❶, 4U	1	0.360
DMED301MID7	RS485 interface, multi-measurements❶, -25...+70°C, 4U	1	0.360
DMED302MID	M-Bus interface, multi-measurements❶, 4U	1	0.360

Digital meter for three-phase with neutral. Connection by CT /5A.

DMED305T2MID	2 programmable static outputs, multi-measurements❶, 4U	1	0.332
DMED330MID	RS485 interface, multi-measurements❶, 4U	1	0.332
DMED332MID	M-Bus interface, multi-measurements❶, 4U	1	0.332

Order code	Description	Qty per pkg	Wt
		n°	[kg]

Digital meter for three-phase with neutral. Connection by CT /5A.

DMED310T2MID	2 programm. static outputs, multi-measurements❶, expandable, with EXM... modules series, 4U graphic LCD display	1	0.332
--------------	---	---	-------

Order code	Description
------------	-------------

DMED310T2 MID EXPANSION MODULES. Inputs and outputs.

EXM1000	2 digital inputs and 2 static outputs, opto-isolated
EXM1001	2 opto-isolated digital inputs and 2 relay outputs rated 5A 250VAC

Communication ports.

EXM1010	Opto-isolated USB interface
EXM1011	Opto-isolated RS232 interface
EXM1012	Opto-isolated RS485 interface
EXM1013	Opto-isolated Ethernet interface
EXM1020	Opto-isolated RS485 interface and 2 relay outputs rated 5A 250VAC

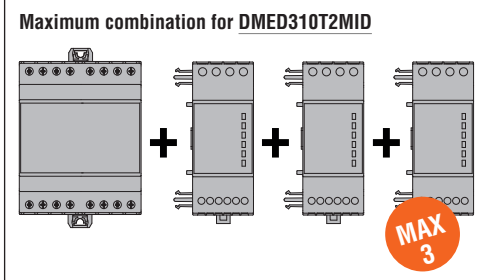

General characteristics

The DME... series energy meters, MID certified, are compulsory in Europe, are needed for billing purposes between electricity suppliers and consumers and for energy consumption measurement in directly or CT connected three-phase installations.

Operational characteristics

- LCD multifunction meter
- Nominal supply voltage: 230VAC (L-N); 400VAC (L-L)
- Voltage range: 187...264VAC (L-N); 323...456VAC (L-L)
- Active energy measurement and accuracy: Class B (EN 50470-3)
- Reactive energy measurement and accuracy: Class 2 (IEC/EN/BS 62053-23)
- Metrological LED with pulse emission for consumption indication
- Clearable partial energy measurements
- 1 programmable digital input
- Built-in RS485 or M-Bus ports for pulse output models compatible with Synergy and Xpress
- 70°C model ideal for electric vehicle charging stations
- Optical interface for EXM... expansion modules with DMED310T2MID
- Modular housing 4 module
- Sealable terminal blocks, standard supplied
- EN degree of protection: IP40 on front; IP20 at terminals.

Synergy supervision and energy management software See Section 30.

Xpress configuration and remote control software See Section 30.

EXM series expansion modules See page 31-3.

Certifications and compliance

Certifications obtained: MID Class B (EN 50470-1, EN 50470-3), certifications per module B (type tests) + per module D (production conformity). Compliant with standards: EN/BS 50470-1, EN/BS 50470-3, TR50579.

❶ Multi-measurements:

- Total and partial active energy
- Total and partial reactive energy
- Voltage
- Current
- Active and reactive power
- Power factor
- Frequency
- Total and partial hour counter
- Average active power (calculation made using the last 15 minutes of data)
- Maximum demand.

Three-phase with neutral,
MID certified

MID



DMED300F



EXM1010

Order code	Description	Qty per pkg	Wt
		n°	[kg]

Digital meter for three-phase with neutral, non expandable, complete with UTF certificates for installations in Italy.

DMED300F	DMED300T2MID, complete with UTF certificate	1	0.360
DMED301F	DMED301MID, complete with UTF certificate	1	0.381
DMED305F	DMED305T2MID, complete with UTF certificate	1	0.381
DMED330F	DMED330MID, complete with UTF certificate	1	0.381

Digital meter for three-phase with neutral, expandable, complete with UTF certificates for installations in Italy.

DMED310F	DMED310T2MID, complete with UTF certificate	1	0.381
-----------------	---	---	-------

Order code	Description
------------	-------------

DMED310F EXPANSION MODULES.
Inputs and outputs.

EXM1000	2 digital inputs and 2 static outputs, opto-isolated
EXM1001	2 opto-isolated digital inputs and 2 relay outputs rated 5A 250VAC
EXM1002	4 opto-isolated digital inputs and 2 relay outputs rated 5A 250VAC

Communication ports.

EXM1010	Opto-isolated USB interface
EXM1011	Opto-isolated RS232 interface
EXM1012	Opto-isolated RS485 interface
EXM1013	Ethernet interface with Web server function
EXM1020	Opto-isolated RS485 interface and 2 relay outputs rated 5A 250VAC

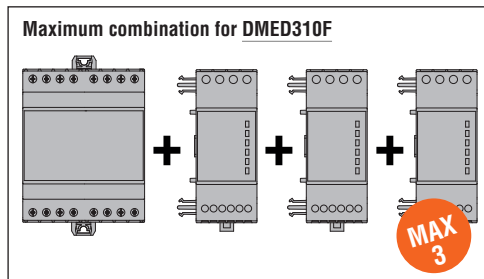

General characteristics

The UTF (Finance Technical Office) certification is required in Italy in case of applications where taxes have to be paid due to energy production (Italian regulations for plants >20kW). The certificates must be associated to the energy meter (MID version) and to each single current transformer is needed (see page 25-17 for selection).

DME... energy meters, MID version, for three-phase systems with or without current transformers can be supplied with the certificates included (DME...F). DMED310F... can be expanded up to 3 EXM... modules.

If required, the fifth certificate relevant to the meter and current transformer combination can be supplied as well (see page 25-17).

Operational characteristics

- LCD multifunction meter
- Nominal supply voltage: 230VAC (L-N); 400VAC (L-L)
- Voltage range: 187...264VAC (L-N); 323...456VAC (L-L)
- Active energy measurement and accuracy: Class B (EN 50470-3)
- Reactive energy measurement and accuracy: Class 2 (IEC/EN/BS 62053-23)
- Metrological LED with pulse emission for consumption indication
- Clearable partial energy measurements
- 1 programmable digital input
- Models with 2 programmable static outputs and built-in RS485 compatible with Synergy and Xpress
- Optical interface for EXM... expansion modules with DMED310F
- Modular housing 4 module
- Sealable terminal blocks, standard supplied
- EN degree of protection: IP40 on front; IP20 at terminals.

Multi-measurements

- Total and partial active energy
- Total and partial reactive energy
- Voltage
- Current
- Active and reactive power
- Power Factor
- Frequency
- Total and partial hour counter
- Average active power (calculation made using the last 15 minutes of data)
- Maximum demand.

Synergy supervision and energy management software
See Section 30.

Xpress configuration and remote control software
See Section 30.

EXM series expansion modules
See page 31-3.

Certifications and compliance

Certifications obtained: MID Class B (EN 50470-1, EN 50470-3), certifications per module B (type tests) + per module D (production conformity) for DMED300F and DMED310F energy meters.

UTF certificates are standard supplied.

Compliant with standards: EN 50470-1, EN 50470-3, TR 50579.

Current transformer kit with UTF certificates



DM...

new

new

Order code	Description of CTs included	Qty per pkg n°	Wt [kg]
Kit comprising of three /5A and class 0.5s current transformers			
DM1TP0060FKIT	3 DM1TP0060, complete with UTF certificate	1	1.440
DM1TP0080FKIT	3 DM1TP0080, complete with UTF certificate	1	1.440
DM1TP0100FKIT	3 DM1TP0100, complete with UTF certificate	1	1.560
DM1TP0150FKIT	3 DM1TP0150, complete with UTF certificate	1	1.680
DM1TP0200FKIT	3 DM1TP0200, complete with UTF certificate	1	1.620
DM1TP0250FKIT	3 DM1TP0250, complete with UTF certificate	1	1.620
DM1TP0300FKIT	3 DM1TP0300, complete with UTF certificate	1	1.680
DM1TP0400FKIT	3 DM1TP0400, complete with UTF certificate	1	1.680
DM1TP0600FKIT	3 DM1TP0600, complete with UTF certificate	1	1.680
DM3TP0500FKIT	3 DM3TP0500, complete with UTF certificate	1	2.160
DM3TP0600FKIT	3 DM3TP0600, complete with UTF certificate	1	2.160
DM3TP0800FKIT	3 DM3TP0800, complete with UTF certificate	1	2.280
DM4TP1200FKIT	3 DM4TP1200, complete with UTF certificate	1	2.280
DM5TP1000FKIT	3 DM5TP1000, complete with UTF certificate	1	2.820
DM5TP1250FKIT	3 DM5TP1250, complete with UTF certificate	1	2.760
DM5TP1600FKIT	3 DM5TP1600, complete with UTF certificate	1	2.880
DM5TP2000FKIT	3 DM5TP2000, complete with UTF certificate	1	2.940
DM5TP2500FKIT	3 DM5TP2500, complete with UTF certificate	1	3.120
DM5TP3000FKIT	3 DM5TP3000, complete with UTF certificate	1	2.940

General characteristics

The UTF (Finance Technical Office) certification is required in Italy in case of applications where taxes have to be paid due to energy production (Italian regulations for plants >20kW). The certificates must be associated to the energy meter (MID version, see page 25-12 for selection) and to each single current transformer is needed.

The DM...TP type accuracy current transformers (CTs) can be provided in a kit version made by three CTs and relative UTF certificates.

If required, the fifth certificate relevant to the meter and current transformer combination can be supplied as well.

The DM...TP type accuracy current transformers (CTs) are installed in an electrical system to reduce the line current to a secondary value of 5A compatible with the ammeter inputs of the digital multimeters or protection relays.

DM...TP are accuracy current transformers in class 0.5s without a primary winding and are normally used for high primary current values starting from 60A.

The number of loops of the primary cable does not modify the accuracy but converts the primary current value proportional to secondary current (see page 25-33).

Operational characteristics

- Operating frequency: 50...60Hz
- Secondary output current: 5A
- Overload withstand: 120% I_{pn}
- Rated insulation voltage U_i: 720V
- Rated short time thermal current I_{th}: 40-60I_{pn} for 1 second
- Rated dynamic current I_{dyn}: 2.5I_{th} for 1 second
- Insulation (dry type): class E
- Screw fixing terminals
- Sealable terminal covers
- Fixing on 35mm DIN rail (IEC/EN/BS 60715) or by screws (fixing elements standard supplied with the product)
- EN degree of protection: IP30.
- Ambient conditions
 - Operating temperature: -25...+50°C
 - Storage temperature: -40...+80°C.
 - Relative humidity, non condensing: 90%.

Compliance

Compliant with standards: IEC/EN/BS 61869-2, IEC/EN/BS 61869-1.

System certificate



Order code	Description
DMCERTUTF	UTF system certificate

Expandable



DMECD



EXM1010

Order code	Description	Qty per pkg	Wt
		n°	[kg]
Data concentrator for general use.			
DMECD	With 8 programmable digital inputs, expandable, for data collection + pulse count from DMED..., RS485 port	1	0.337

Order code	Description
------------	-------------

DME CD EXPANSION MODULES.
Inputs and outputs.

EXM1000	2 digital inputs and 2 static outputs, opto-isolated
EXM1001	2 opto-isolated digital inputs and 2 relay outputs rated 5A 250VAC
EXM1002	4 opto-isolated digital inputs and 2 relay outputs rated 5A 250VAC

Communication ports.

EXM1010	Opto-isolated USB interface
EXM1011	Opto-isolated RS232 interface
EXM1012	Opto-isolated RS485 interface
EXM1013	Opto-isolated Ethernet interface
EXM1020	Opto-isolated RS485 interface and 2 relay outputs, rated 5A 250VAC
EXM1030	Data storage, clock-calendar (RTC) with backup reserve energy for data logging

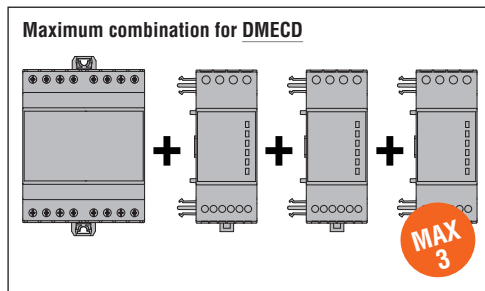

General characteristics

DMECD is equipped with 8 inputs, which can be increased up to a maximum of 14 with expansion modules EXM1000/1001/1002, that allow to indirectly interface devices without communication as long as they have at least one pulse output.

It is capable of pulse counting that comes in from the outputs of meters for energy, water, gas and other types of consumption: All data is viewed on its display or can also be available for PCs through its built-in RS485 interface using Synergy or Xpress software.

It can be expanded with up to 3 EXM... series modules by optical interface.

With the programmable functions, average values can be determined for instantaneous quantities, such as power, speed, production rate, gas and water consumption, etc.

Operational characteristics

- Backlight graphic LCD meter, multifunction
- Nominal supply voltage: 100...240VAC/110...250VDC
- Voltage range: 85...264VAC/93.5...300VDC
- 8 inputs, expandable with EXM... modules up to 14
- Built-in RS485 communication port
- Modbus-RTU, ASCII and TCP communication protocol
- Clearable total and partial counters for each channel
- Programmable general counters
- Calculation of derivative average values
- Mathematical operations among counters
- Modular housing, 4 module
- EN degree of protection: IP40 on front; IP20 at terminals.

Synergy supervision and energy management software
See Section 30.

Xpress configuration and remote control software
See Section 30.

EXM series expansion modules
See page 31-3.

Certifications and compliance

Certifications obtained: cULus, EAC.
Compliant with standards: IEC/EN/BS 61010-1, IEC/EN/BS 61000-6-2, IEC/EN/BS 61000-6-3.

Power analyzers with widescreen colour LCD



DMG...



new

Order code	Description	Qty per pkg	Wt
		n°	[kg]
Auxiliary supply 100...240VAC.			
DMG7000	Expandable with 3 EXP... modules	1	0.375
DMG7500	Expandable with 3 EXP... modules, built-in RS485 port, compatible with EASY BRANCH power monitoring system	1	0.375
DMG8000	Expandable with 3 EXP... modules, built-in Ethernet port, data memory for logging, compatible with EASY BRANCH power monitoring system	1	0.375
DMG9000	Expandable with 3 EXP... modules, built-in RS485 and Ethernet port, data memory for logging, compatible with EASY BRANCH power monitoring system	1	0.375

Expansion modules



EXP10...



Order code	Description	Qty per pkg	Wt
		n°	[kg]
Inputs and outputs.			
EXP1000	4 opto-isolated digital inputs	1	0.060
EXP1001	4 opto-isolated static outputs	1	0.054
EXP1002	2 digital inputs and 2 static outputs, opto-isolated	1	0.058
EXP1003	2 relay outputs rated 5A 250VAC	1	0.050
EXP1004	2 analog inputs, opto-isolated 0/4...20mA or PT100 or 0...±10V or 0...±5V	1	0.056
EXP1005	2 analog outputs, opto-isolated 0/4...20mA, 0-10V or 0...±5V	1	0.064
EXP1008	2 opto-isolated digital inputs and 2 relay outputs rated 5A 250VAC	1	0.058
Communication ports.			
EXP1010	Opto-isolated USB interface	1	0.060
EXP1011	Opto-isolated RS232 interface	1	0.040
EXP1012	Opto-isolated RS485 interface	1	0.050
EXP1013	Opto-isolated Ethernet interface	1	0.060
EXP1014	Opto-isolated Profibus-DP interface	1	0.080

Communication devices



CX01



CX02

Order code	Description	Qty per pkg	Wt
		n°	[kg]
CX01	USB/optical device with PC ↔ LOVATO Electric product connecting cable, for programming, data download, diagnostics and firmware upgrade	1	0.090
CX02	Wi-Fi device for PC ↔ LOVATO Electric product programming, data download, diagnostics and cloning	1	0.090

General characteristics

DMG... power analysers display electrical values on their large colour LCD display with exceptional accuracy to enable precise monitoring of power grids. They are designed in flush-mount housing (cutout 92x92mm/3.62x3.62") with 3 slots for EXP series plug-in expansion modules to adapt them to a variety of applications.

The use of NFC technology allows the user to configure the unit and make settings with a smart device. The optical port on the back of the unit enables the user to make settings, run power grid diagnostics and update the unit's firmware. The graphic interface, available in 10 languages (English, French, German, Italian, Spanish, Portuguese, Polish, Russian, Czech and Chinese), has been designed to facilitate the display of data, including:

- Voltage (phase, phase-to-phase and system)
- Phase current (calculated neutral current, and measured neutral current on the DMG9000)
- Measurements on 4 quadrants
- Power (active, reactive and apparent phase and total power)
- Power factor (phase and total)
- Frequency
- Maximum (HIGH), minimum (LOW) and average (AVERAGE) of all measured values
- Peak power/current (max demand)
- Voltage and current asymmetry and active power unbalance
- Total harmonic distortion (voltage and current)
- Voltage and current harmonic analysis up to the 63rd order
- Active, reactive and apparent energy metering (partial and total)
- Hour meter (total and partial, programmable).

The EASY BRANCH multi-circuit measurement system

The DMG7500, DMG8000 and DMG9000 can also be used in multi-circuit applications when more than one load is to be monitored in the electrical switch board. All values are shown on the display or via the integrated communications interface.

Refer to page 25-20 for the components of the EASY BRANCH measurement system.

Operational characteristics

- Auxiliary power: 100...240VAC/110...250VDC
- Voltage measurement range: 50...720VAC L-L
- can be used in medium and high voltage systems using TV
- Nominal input current: 5A or 1A with an external current transformer
- Frequency measurement range: 45...66Hz, 360...440Hz
- Accuracy (IEC/BS 61557-12):
 - voltage: Class 0.5 (Vref = 400VAC L-L)
 - current: Class 0.2 (Iref = 5AAC)
 - power: Class 0.5 (active), Class 1 (reactive)
 - power factor: Class 0.5
 - frequency: Class 0.02
 - THD and harmonics V and I: Class 5
 - active energy: Class 0.5s
 - active energy: Class 0.5s (IEC/EN/BS 62053-22)
 - reactive energy: Class 1 (IEC/EN/BS 62053-24)
- Integrated data memory (DMG8000, DMG9000)
- Integrated communications ports (RS485 or Ethernet)
- Communications protocols: Modbus-RTU, ASCII and TCP
- Compatible with Synergy, Xpress and App NFC
- Protection rating: IP65 for front panel.

Synergy supervision and energy management software
See Section 30.

Xpress configuration and remote control software
See Section 30.

Lovato App NFC
See Section 30.

EXP series expansion modules
See page 31-2.

Certifications and compliance
Compliant with standards: IEC/EN/BS 61010-1, IEC/EN/BS 61000-6-2 and IEC/EN/BS 61000-6-4.

For versions with 12...48VDC power, contact our Technical Service office; see contact details on inside front cover.

EASY BRANCH power monitoring system



EXS0000



EXS4000



EXS4001



EXS1063

EXS3063

new

Order code	Description	Qty per pkg	Wt
		n°	[kg]

Modules for EASY BRANCH system.			
EXS0000	Bus module for EASY BRANCH power monitoring system	1	0.090
EXS4000	Current measuring module with 4 inputs for electronic RJ45 CTs	1	0.140
EXS4001	Current measuring module with 2 inputs for three-phase traditional CTs or 6 inputs for single-phase traditional CTs	1	0.210

Electronic current transformers for EASY BRANCH system. Single-phase.			
EXS1032	32A single-phase electronic current transformer with RJ45 cable, 2m long	1	0.060
EXS1063	63A single-phase electronic current transformer with RJ45 cable, 2m long	1	0.060
EXS1080	80A single-phase electronic current transformer with RJ45 cable, 2m long	1	0.105
EXS1125	125A single-phase electronic current transformer with RJ45 cable, 2m long	1	0.105

Three-phase. ①			
EXS3032	32A three-phase electronic current transformer ① with RJ45 cable, 2m long	1	0.080
EXS3063	63A three-phase electronic current transformer ① with RJ45 cable, 2m long	1	0.080
EXS3080	80A three-phase electronic current transformer ① with RJ45 cable, 2m long	1	0.135
EXS3125	125A three-phase electronic current transformer ① with RJ45 cable, 2m long	1	0.135

Traditional current transformers.
See page 25-31 to 25-35.

① Configurable as single-phase current transformer (3 single-phase measure per each EXS3...).

General characteristics

The EASY BRANCH multi-circuit metering system is a modern solution to the need for electrical parameter metering when more than one load is to be monitored inside a single electrical enclosure. Each DIN rail mounting current metering unit can monitor 2 or 4 measurement points and display the values on the DMG7500, DMG8000 or DMG9000 power analysers to which it is connected, thus centralising the display of data, which includes:

- Phase current
- Measurements on 4 quadrants
- Power (active, reactive and apparent phase and total power)
- Power factor (phase and total)
- Maximum (HIGH), minimum (LOW) and average (AVERAGE) of all measured values
- Peak power/current (max demand)
- Current asymmetry and active power unbalance
- Total harmonic distortion (current)
- Current harmonic analysis up to the 63rd order
- Active, reactive and apparent energy metering (partial and total).

The RJ45 port on the EXS4000 metering module provides foolproof connection of EXS1... and EXS3... electronic current transformers.

The values can also be monitored using the communications ports of DMG... power analysers, to which up to 8 current metering modules can be connected in cascade thanks to the integrated communications bus with standard Ethernet cable (cat. 6), which also provides power.

Connecting 5 or more EXS4... current metering modules requires a 24VDC-0.2A power supply. Each measurement point can be configured as single- or three-phase, up to a total of 33 three-phase or 99 single-phase points.

Operational characteristics of EXS4... current measuring modules

- Power supplied by the bus cable (connecting 5 or more EXS4... current metering modules requires a 24VDC-0.2A power supply)
- nominal input current:
EXS4000: 32A, 63A, 80A or 125A, depending on the connected EXS1... or EXS3... electronic transformer.
EXS4001: 5A or 1A via external current transformer
- Accuracy (IEC/BS 61557-12):
 - current: Class 0.5 (Iref = 5AAC)
 - power: Class 1 (active), Class 2 (reactive)
 - power factor: Class 1
 - THD and current harmonics: Class 5
 - active energy: Class 1
 - active energy: Class 1 (IEC/EN/BS 62053-21)
 - reactive energy: Class 2 (IEC/EN/BS 62053-23)
- Diagnostics LED indicates correct power supply and electronic current transformer recognition
- Mounts to 35mm omega rail (IEC/EN/BS 60715).

Operational characteristics of EXS1... - EXS3... electronic current transformers

- Diagnostics LED to confirm connection
- Pre-wired cable: 2m
- RJ45 connector.

Synergy supervision and energy management software
See Section 30.

Xpress configuration and remote control software
See Section 30.

Lovato App NFC
See Section 30.

Certifications and compliance

Compliant with standards: IEC/EN/BS 61010-1, IEC/EN/BS 61000-6-2 and IEC/EN/BS 61000-6-4.

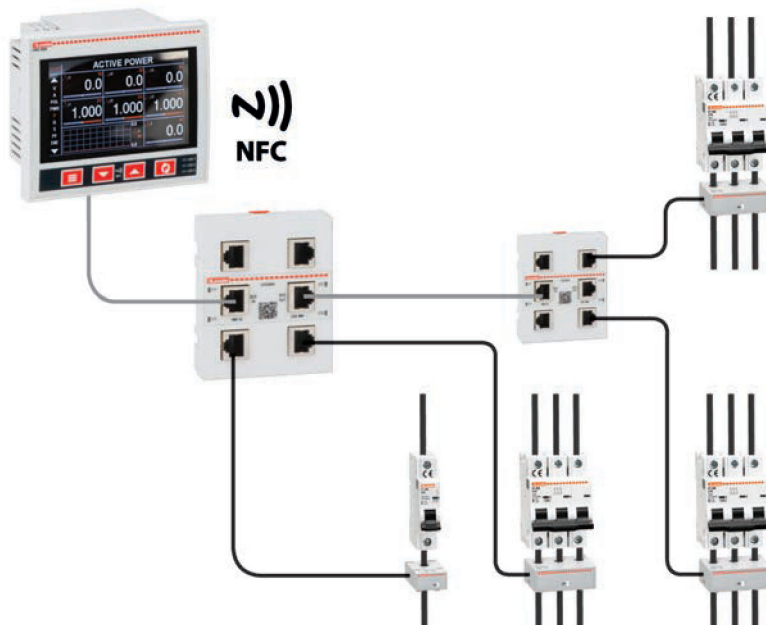

Digital metering instruments.
Metering and current transformer kits

Modular LCD multimeters, non expandable



DMG1...



DMG200 - DMG210

Kits with CT



DMGKIT100150

Order code	Description	Qty per pkg.	Wt
		n°	[kg]
DMG100	Icon LCD, auxiliary supply 100...240VAC/120...250VDC. Multilanguage: Italian, English, French, Spanish, Portuguese and German	1	0.294
DMG110	Icon LCD, built-in RS485 port, auxiliary supply 100...240VAC/120...250VDC. Multilanguage: Italian, English, French, Spanish, Portuguese and German	1	0.294
DMG200	Graphic 128x80 pixel LCD, auxiliary supply 100-240VAC/110-250VDC. Multilanguage: Italian, English, French, Spanish and Portuguese	1	0.294
DMG200L01	Graphic 128x80 pixel LCD, auxiliary supply 100-240VAC/110-250VDC. Multilanguage: English, Czech, Polish, German and Russian	1	0.294
DMG210	Graphic 128x80 pixel LCD, built-in RS485 port, auxiliary supply 100-240VAC/110-250VDC. Multilanguage: Italian, English, French, Spanish and Portuguese	1	0.300
DMG210L01	Graphic 128x80 pixel LCD, built-in RS485 port, auxiliary supply 100-240VAC/110-250VDC. Multilanguage: English, Czech, Polish, German and Russian	1	0.300

Order code	Description	Qty per pkg.	Wt
		n°	[kg]
DMGKIT100060	Composed of one DMG100 multimeter and n°3 CTs 60/5A for Ø22mm cable	1	1.035
DMGKIT100100	Composed of one DMG100 multimeter and n°3 CTs 100/5A for Ø22mm cable	1	1.035
DMGKIT100150	Composed of one DMG100 multimeter and n°3 CTs 150/5A for Ø23mm cable	1	0.856
DMGKIT100250	Composed of one DMG100 multimeter and n°3 CTs 200/5A for Ø23mm cable	1	0.856

General characteristics

DMG... digital multimeters are available with a modular housing, 4 module size, and are equipped with a graphic backlight LCD (except DMG100/110 with icon display) capable of providing extremely clear, intuitive and flexible viewing of all electrical parameters of an installation.

For DMG110 and DMG210 versions, there is a built-in isolated RS485 interface.

Main measurements:

- Voltage: phase, line and system values
- Current: phase values (neutral current calculated)
- Power: apparent, active and reactive phase and total values
- P.F.: Power Factor per phase and total
- Frequency of measured voltage value
- HIGH-LOW-AVERAGE value functions of all measurements
- Maximum demand of power and current values
- Asymmetric voltage and current
- Total harmonic distortion (THD) of voltage and current values
- Energy meters for active, reactive and apparent values
- Hour counter (total and partial, 1 on DMG200/210, 4 programmable on DMG100/110)
- Phase energy (DMG100/110)
- Harmonic analysis up to the 15th order (DMG100/110).

Operational characteristic

- Auxiliary supply voltage range: 100...240VAC / 110...250VDC
- Maximum rated measurement voltage
 - 600VAC (DMG100/110)
 - 690VAC (DMG200/210)
- Voltage measurement range:
 - 50...720VAC phase-to-phase (DMG100/110)
 - 20...830VAC phase-to-phase (DMG200/210)
- Usage in medium and high-voltage systems with voltage transformers
- Rated input current: With external CT /5A (also 1A for DMG100/110)
- Current measurement range with CT up to 10,000A
- Frequency measurement range: 45...66Hz, 360...440Hz
- True RMS measurements for voltage and current values
- Accuracy:
 - Voltage: ±0.5% (50...720VAC for DMG1... (50...830VAC) for DMG2...
 - Current: ±0.5% (0.1...1.1In)
 - Power: ±1% f.s.
 - Frequency: ±0.05%
 - Active energy: Class 1 (IEC/EN/BS 62053-21)
 - Reactive energy: Class 2 (IEC/EN/BS 62053-23)
- Non-volatile memory for data storage
- Communication protocol Modbus-RTU and ASCII (only for DMG110 and DMG210)
- Programming and remote control by software (only for DMG110 and DMG210; compatible with Synergy and Xpress software)
- Modular housing, 4 module
- EN degree of protection: IP40 on front; IP20 at terminals.

CURRENT TRANSFORMERS OF DMG... KITS

- Operating frequency: 50...60Hz
- Secondary output current: 5A
- Overload withstand: 120% I_{pn}
- Rated insulation voltage U_i: 720V
- Rated short time thermal current I_{th}: 40...60I_{pn} for 1 second
- Rated dynamic current I_{dyn}: 2.5I_{th} for 1 second
- Insulation (dry type): class E
- Faston terminals
- EN degree of protection: IP30.

Synergy supervision and energy management software
See Section 30.

Xpress configuration and remote control software
See Section 30.

Certifications and compliance

Certifications obtained: cULus, EAC and RCM.
Compliant with standards: DMG100/110: IEC/EN/BS 61010-1, IEC/EN/BS 61010-2-030, IEC/EN/BS 61000-6-2, IEC/EN/BS 61000-6-3, UL 61010-1, CSA C22.2 n° 61010-1, UL 61010-2-030, CSA 22.2 n° 61010-2-030.
DMG200/210: IEC/EN/BS 61010-1, IEC/EN/BS 61000-6-2, IEC/EN/BS 61000-6-4, UL 61010-1, UL508, CSA C22.2 n°14.

Modular LCD multimeters, expandable



DMG300

Order code	Description	Qty per pkg	Wt
		n°	[kg]
DMG300	Graphic 128x80 pixel LCD, harmonic analysis, auxiliary supply 100...240VAC/110...250VDC, expandable with modules series EXM... Multilanguage: Italian, English, French, Spanish and Portuguese	1	0.320
DMG300L01	Graphic 128x80 pixel LCD, harmonic analysis, auxiliary supply 100...240VAC/110...250VDC, expandable with modules series EXM... Multilanguage: English, Czech, Polish, German and Russian	1	0.320

Expansion modules



EXM1010

Order code	Description
DMG300 AND DMG300L01 EXPANSION MODULES. Inputs and outputs.	
EXM1000	2 digital inputs and 2 static outputs, opto-isolated
EXM1001	2 opto-isolated digital inputs and 2 relay outputs rated 5A 250VAC
EXM1002	4 opto-isolated digital inputs and 2 relay outputs rated 5A 250VAC
Communication ports.	
EXM1010	Opto-isolated USB interface
EXM1011	Opto-isolated RS232 interface
EXM1012	Opto-isolated RS485 interface
EXM1013	Opto-isolated Ethernet interface
EXM1020	Opto-isolated RS485 interface and 2 relay outputs rated 5A 250VAC
EXM1030	Data storage, clock-calendar (RTC) with backup battery for data logging

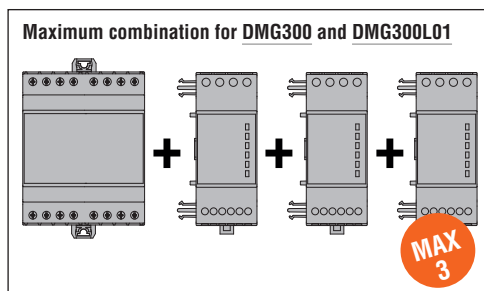

General characteristics

DMG300... digital multimeters are available with a modular housing, 4 module size, and are equipped with a graphic backlight LCD capable of providing extremely clear, intuitive and flexible viewing of all electrical parameters of a system. The very accurate measurements combined with their extreme compactness provide an ideal solution for every type of application. Expandable with up to 3 module EXM... series by optical interface.

Main measurements:

- Voltage: phase, line and system values
- Current: phase values (neutral current calculated)
- Power: apparent, active and reactive phase and total values
- P.F.: Power Factor per phase and total
- Frequency of measured voltage value
- HIGH-LOW-AVERAGE value functions for all measurements
- Maximum demand of power and current values
- Voltage and current asymmetry
- Total harmonic distortion (THD) of voltage and current values
- Harmonic analysis of voltage and current up to 31° order
- Energy meters for active, reactive, apparent partial and total values, programmable tariff functions
- Hour counter for programmable total and partial hours
- Pulse counter for general use: consumption pulse counting for water, gas, etc. with expansion module only.

Operational characteristics

- Auxiliary supply voltage range: 85...264VAC / 93.5...300VDC
- Voltage measurement range: 20...830VAC phase-to-phase
10...480VAC phase-neutral
- Usage in medium and high-voltage systems with voltage transformers
- Rated input current: With external CT, 5A or 1A
- Current measurement range with CT up to 10,000A
- Frequency measurement range: 45...66Hz, 360...440Hz
- True RMS measurements for voltage and current values
- Measurements accuracy:
 - Voltage: ±0.2% (50...830VAC)
 - Current: ±0.2% (0.1...1.1In)
 - Power: ±0.5% f.s.
 - Power factor: ±0.5%
 - Frequency: ±0.05%
 - Active energy: Class 0.5s (IEC/EN/BS 62053-22)
 - Reactive energy: Class 2 (IEC/EN/BS 62053-23)
- Non-volatile memory for data storage
- Communication protocol Modbus-RTU, ASCII and TCP (only with communication expansion modules)
- Programming and remote control by software (only with communication expansion modules); compatible with **Synergy** and **Xpress** software
- Modular housing, 4 module
- EN degree of protection: IP40 on front; IP20 at terminals.

Synergy supervision and energy management software
See Section 30.

Xpress configuration and remote control software
See Section 30.

EXM series expansion modules
See page 31-3.

Certifications and compliance

Certifications obtained: UL Listed, for USA and Canada (cULus - File E93601), as Auxiliary Devices - Multimeters; EAC and RCM for all.

Compliant with standards: IEC/EN/BS 61010-1, IEC/EN/BS 61000-6-2, IEC/EN/BS 61000-6-4, UL508, CSA C22.2 n° 14.

Flush-mount LCD multimeters, expandable



DMG600 - DMG610
DMG615 - DMG620



DMG611R...

new

Order code	Description	Qty per pkg	Wt [kg]
	Icon LCD 72x46mm/2.83x1.81", backlight, harmonic analysis, auxiliary supply 100...440/110...250VDC, expandable with modules series EXP...	n°	[kg]
DMG600	Front optical port, multilanguage ^①	1	0.300
DMG610	Front optical port, built-in RS485 serial port, multilanguage ^①	1	0.350
DMG611R0100	Front optical port, built-in RS485 serial port, multilanguage ^① . Current reading through 3 Rogowski coils included, max current 100A	1	0.350
DMG611R0500	Front optical port, built-in RS485 serial port, multilanguage ^① . Current reading through 3 Rogowski coils included, max current 500A	1	0.350
DMG611R3000	Front optical port, built-in RS485 serial port, multilanguage ^① . Current reading through 3 Rogowski coils included, max current 3000A	1	0.350
DMG611R6300	Front optical port, built-in RS485 serial port, multilanguage ^① . Current reading through 3 Rogowski coils included, max current 6300A	1	0.350
DMG615	Front optical port, built-in RS485 serial port, multilanguage ^① . class 0.5s	1	0.350
DMG620	Front optical port, built-in Ethernet port, multilanguage ^① . class 0.5s	1	0.350

^① Italian, English, French, Spanish and Portuguese.

General characteristics

DMG6... digital multimeters are capable of viewing the measurements with high accuracy on the wide icon LCD, which allow to control energy distribution networks. They are available with a flush-mount housing, (96x96mm/3.78"x3.78") and 1 expansion slot to fit plug-in expansion modules, suitable for numerous applications. The main features include an extended power supply voltage range, high measurement accuracy, expandability and icon interactive interface for simple use. They are equipped with a front optical port for programming via USB (CX01) or Wi-Fi (CX02) communication devices to allow:

- Configuration of parameters
 - Parameters copy
 - Cloning of stored data.
- Main measurements:
- Voltage: phase, line and system values
 - Current: phase values (neutral current calculated)
 - Power: apparent, active and reactive phase and total values
 - P.F.: Power Factor per phase and total
 - Frequency of measured voltage value
 - HIGH-LOW-AVERAGE value functions for all measurements
 - Maximum demand of power and current values
 - Voltage and current asymmetry
 - Total harmonic distortion (THD): voltage and current
 - Harmonic analysis of voltage and current up to the 15th order
 - Energy meters for active, reactive, apparent partial and total values
 - Hour counter for programmable total and partial hours.

Operational characteristics

- Auxiliary supply voltage range:
 - 100...440VAC / 110...250VDC[Ⓜ]
- Voltage measurement range: 50...720VAC L-L
- Usage in medium and high voltage systems with voltage transformers
- Rated input current: By external CT 5A or 1A
- Current reading through Rogowski coils for DMG611...
- Frequency measurement range 45...66Hz, 360...440Hz
- True RMS measurements: for voltage and current
- Measurement accuracy:
 - Voltage: ±0.5% (50...720VAC)
 - Current: ±0.5% (0.1...1.1In)
 - Power: ±1% f.s.
 - Frequency: ±0.05%
 - Active energy: Class 1 (IEC/EN/BS 62053-21)
 - Reactive energy: Class 2 (IEC/EN/BS 62053-23)
- Measurement accuracy DMG615/620::
 - Voltage: ±0.2% (50...720VAC)
 - Current: ±0.2% (0.1...1.1In)
 - Power: ±0.5% f.s.
 - Frequency: ±0.05%
 - Active energy: Class 0.5 (IEC/EN/BS 62053-22)
 - Reactive energy: Class 2 (IEC/EN/BS 62053-23)
- Non-volatile memory for data storage
- Communication protocol Modbus-RTU, ASCII and TCP
- Compatible **Synergy** and **Xpress** software
- Flush-mount housing 96x96mm/3.78"x3.78"
- EN degree of protection: IP54 on front.

Synergy supervision and energy management software
See Section 30.

Xpress configuration and remote control software
See Section 30.

EXP series expansion modules
See page 31-2.

Certifications and compliance

Certifications obtained: cULus (except DMG611... and DMG620), EAC, RCM; UL listed for USA and Canada (cULus - File E93601), as Auxiliary Devices - Multimeters. Compliant with standards: IEC/EN/BS 61010-1, IEC/EN/BS 61010-2-030, IEC/EN/BS 61000-6-2, IEC/EN/BS 61000-6-3, UL 61010-1, CSA C22.2 n° 61010-1, UL 61010-2-030, CSA 22.2 n° 61010-2-030.

[Ⓜ] Consult Technical support about versions with supply 12...48VDC

Expansion modules



EXP10...



Order code	Description	Qty per pkg	Wt [kg]
	EXPANSION MODULES Inputs and outputs.		
EXP1000	4 opto-isolated digital inputs		
EXP1001	4 opto-isolated static outputs		
EXP1002	2 digital inputs and 2 static outputs, opto-isolated		
EXP1003	2 relay outputs rated 5A 250VAC		
EXP1008	2 opto-isolated digital inputs and 2 relay outputs rated 5A 250VAC		
	Communication ports.		
EXP1010	Opto-isolated USB interface		
EXP1011	Opto-isolated RS232 interface		
EXP1012	Opto-isolated RS485 interface		
EXP1013	Opto-isolated Ethernet interface		

Communication devices



CX01



CX02

Order code	Description	Qty per pkg	Wt [kg]
		n°	[kg]
CX01	USB/optical device with PC ↔ LOVATO Electric product connecting cable, for programming, data download, diagnostics and firmware upgrade	1	0.090
CX02	Wi-Fi device for PC ↔ LOVATO Electric product programming, data download, diagnostics and cloning	1	0.090



Modular LED instruments single-phase, non expandable



DMK80R1



DMK81R1

Order code	Displayed measurements	Relay output	Qty per pkg	Wt
	n°	n°	n°	[kg]
Voltmeter.				
DMK80R1 	1 voltage value 1 max voltage value 1 min voltage value	1	1	0.268
Ammeter.				
DMK81R1 	1 current value 1 max current value 1 min current value	1	1	0.268

 Relay output with control and protection functions.

General characteristics

The DMK8... instruments are available with modular housing, 3 module size.

Measurements are True RMS values and provide for reliable operation even in the presence of harmonics.

Operational characteristics

- Auxiliary supply voltage: 220...240VAC
- Operating frequency: 50...60Hz
- True RMS measurements
- Max and min measurement storage
- 1 relay output with 1 changeover contact (SPDT)
- Modular DIN 43880 housing, 3 modules
- Terminals: 4mm²
- EN degree of protection: IP40 on front; IP20 on terminals.

DMK80R1

- Voltage measurement range: 15...660VAC
- Operating frequency range: 45...65Hz
- Programmable VT ratio: 1.00...500.00
- Accuracy: $\pm 0.25\%$ f.s. ± 1 digit

DMK81R1

- Current measurement range: 0.05...5.75A
- Operating frequency range: 45...65Hz
- Programmable CT ratio: 5...10,000
- Accuracy: $\pm 0.5\%$ f.s. ± 1 digit

Control and protection functions

DMK80R1

- Voltage loss or failure: OFF/5...85%
- Maximum voltage: OFF/102...120%
- Minimum voltage: OFF/70...98%
- Time delay for max-min voltage or voltage loss : 0.0...900.0 seconds.

DMK81R1

- Current loss: OFF/2...100%
- Maximum current: OFF/102...200%
- Maximum current instantaneous tripping: OFF/110...600%
- Minimum current: OFF/5...98%
- Time delay for max-min current or current loss : 0.0...900.0 seconds.

Certifications and compliance

Certifications obtained: EAC.

Compliant with standards: IEC/EN/BS 61010-1, IEC/EN/BS 61000-6-2, IEC/EN/BS 61000-6-3.

 Independent adjustable delays.

Modular LED instruments three-phase, non expandable



DMK70R1



DMK71R1



DMK75R1

Order code	Displayed measurements	Relay output	Qty per pkg	Wt [kg]
	n°	n°	n°	[kg]
Voltmeter.				
DMK70R1 Ⓢ	3 phase voltage values 3 phase to phase voltage values 3 max phase voltage values 3 max phase to phase voltage values 3 min phase voltage values 3 min phase to phase voltage values	1	1	0.264
Ammeter.				
DMK71R1 Ⓢ	3 phase current values 3 max phase current values 3 min phase current values	1	1	0.272
Combined voltmeter, ammeter and wattmeter.				
DMK75R1 ⓈⓈ	3 phase voltage values 3 phase to phase voltage values 3 phase current values 4 active power values, phase and total 3 maximum phase voltage values 3 maximum phase to phase voltage values 3 maximum phase current values 4 max active power, phase and total 3 minimum phase voltage values 3 minimum phase to phase voltage values 3 minimum phase current values 4 min active power, phase and total	1	1	0.280

- ① Connection also to single-phase.
- Ⓢ Relay output with control and protection functions.

General characteristics

The DMK7... instruments are available with modular housing, 3 module size. Measurements are True RMS values and provide for reliable operation even in the presence of harmonics.

Operational characteristics

- Auxiliary supply voltage: 220...240VAC
- Operating frequency: 50...60Hz
- True RMS measurements
- Max and min measurement storage
- 1 relay output with 1 changeover contact (SPDT)
- Modular DIN 43880 housing, 3 module
- Terminals: 4mm²
- EN degree of protection: IP40 on front; IP20 on terminals.

DMK70R1

- Voltage measurement range: 15...660VAC
- Operating frequency range: 45...65Hz
- Programmable VT ratio: 1.00...500.00
- Accuracy: ±0.25% f.s. ±1 digit

DMK71R1

- Current measurement range: 0.05...5.75A
- Operating frequency range: 45...65Hz
- Programmable CT ratio: 5...10,000
- Accuracy: ±0.5% f.s. ±1 digit

DMK75R1

- Voltage measurement range: 35...660VAC
- Current measurement range: 0.05...5.75A
- Frequency measure range: 45...65Hz
- Programmable VT ratio: 1.00...500.00
- Programmable CT ratio: 5...10,000
- Accuracy: Voltage ±0.25% f.s. ±1 digit
- Accuracy: Current ±0.5% f.s. ±1 digit

Control and protection functions

DMK70R1

- Phase loss or failure: OFF/5...85%
- Maximum voltage: OFF/102...120%
- Minimum voltage: OFF/70...98%
- Asymmetry: OFF/2...20%
- Phase sequence: OFF/L1-L2-L3/L3-L2-L1
- Maximum frequency: OFF/101...110%
- Minimum frequency: OFF/90...99%
- Time delay for max-min voltage, phase loss, asymmetry and min-max frequency Ⓢ: 0.0...900.0 seconds.

DMK71R1

- Current loss: OFF/2...100%
- Maximum current: OFF/102...200%
- Maximum current instantaneous tripping: OFF/110...600%
- Minimum current: OFF/5...98%
- Asymmetry: OFF/2...20%
- Time delay for max-min current or current loss and asymmetry Ⓢ: 0.0...900.0 seconds.

DMK75R1

Voltage

- Phase loss or failure: OFF/5...85%
- Maximum voltage: OFF/102...120%
- Minimum voltage: OFF/70...98%
- Asymmetry: OFF/2...20%
- Phase sequence: OFF/L1-L2-L3/L3-L2-L1

Current

- Current loss: OFF/2...100%
- Maximum current: OFF/102...200%
- Maximum current instantaneous tripping: OFF/110...600%
- Minimum current: OFF/5...98%
- Asymmetry: OFF/2...20%

Power

- Rated power: 1...10,000
- Maximum power: OFF/101...200%
- Maximum power instantaneous tripping: OFF/110...600%
- Minimum power: OFF/10...99%

Frequency

- Maximum frequency: OFF/101...110%
- Minimum frequency: OFF/90...99%
- Time delay for max-min voltage, max-min current or current loss, phase loss, asymmetry and min-max power Ⓢ: 0.0...900.0 seconds.

Certifications and compliance

Certifications obtained: EAC.
Compliant with standards: IEC/EN/BS 61010-1, IEC/EN/BS 61000-6-2, IEC/EN/BS 61000-6-3.

- Ⓢ Independent adjustable delays.

Flush-mount LED instruments single-phase, non expandable



DMK0...

Order code	Displayed measurements	Relay output	Qty per pkg	Wt [kg]
	n°	n°	n°	[kg]
Voltmeter.				
DMK00R1 Ⓜ	1 voltage value 1 max voltage value 1 min voltage value	1	1	0.323
Ammeter.				
DMK01R1 Ⓜ	1 current value 1 max current value 1 min current value	1	1	0.323
Voltmeter or ammeter.				
DMK02 Ⓜ	1 voltage or current value 1 maximum voltage or current value 1 minimum voltage or current value	–	1	0.290

Ⓜ The DMK02 can operate as a voltmeter or ammeter. It is duly equipped with two front plates (V and A) which must be fitted by the user depending on which instrument is required and on the wiring scheme used.

Ⓜ Relay output for control and protection functions.

General characteristics

The DMK0... instruments are available with flush-mount housing, 96x48mm/3.78x1.89". Measurements are True RMS values and provide for reliable operation even in the presence of harmonics.

Operational characteristics

- Auxiliary supply voltage: 220...240VAC;
- Operating frequency: 50...60Hz
- True RMS measurements
- Max. and min. measurement storage
- 1 relay output with 1 changeover contact (for DMK...R1 only)
- Housing: flush-mount 96x48mm/3.78x1.89"
- Terminals: 4mm²
- Degree of protection: IP54 on front; IP20 at terminals.

DMK00R1

- Voltage measurement range: 15...660VAC
- Operating frequency range: 45...65Hz
- Programmable VT ratio: 1.00...500.00
- Accuracy: ±0.25% f.s. ±1 digit

DMK01R1

- Current measurement range: 0.05...5.75A
- Operating frequency range: 45...65Hz
- Programmable CT ratio: 5...10,000
- Accuracy: ±0.5% f.s. ±1 digit

DMK02

- Voltage measurement range: 1...660VAC
- Current measurement range: 0.05...5.75A
- Operating frequency range: 45...65Hz
- Programmable VT ratio: 1.00...500.00
- Programmable CT ratio: OFF/5...10,000
- Accuracy: Voltage ±0.25% f.s. ±1 digit
Current ±0.5% f.s. ±1 digit

Control and protection functions

DMK00R1

- Voltage loss or failure: OFF/5...85%
- Maximum voltage: OFF/102...120%
- Minimum voltage: OFF/70...98%
- Time delay for max-min voltage or voltage lossⓂ: 0.0...900.0 seconds.

DMK01R1

- Current loss: OFF/2...100%
- Maximum current: OFF/102...200%
- Maximum current instantaneous tripping: OFF/110...600%
- Minimum current: OFF/5...98%
- Time delay for max-min current or current lossⓂ: 0.0...900.0 seconds.

Certifications and compliance

Certifications obtained: UL Listed, for USA and Canada (cULus - File E93601), as Auxiliary Devices-Multimeters; EAC. Compliant with standards: IEC/EN/BS 61010-1, IEC/EN/BS 61000-6-2, IEC/EN/BS 61000-6-3, UL508, CSA C22.2 n° 14.

Ⓜ Independent adjustable delays.

Flush-mount LED instruments three-phase, non expandable



DMK1...

Order code	Displayed measurements	Relay output	Qty per pkg	Wt [kg]
	n°	n°	n°	[kg]
Voltmeter.				
DMK10R1 Ⓜ	3 phase voltage values 3 phase to phase voltage values 3 maximum phase voltage values 3 maximum phase to phase voltage values 3 minimum phase voltage values 3 minimum phase to phase voltage values	1	1	0.330
Ammeter.				
DMK11R1 Ⓜ	3 phase current values 3 maximum phase current values 3 minimum phase current values	1	1	0.336
Voltmeter, ammeter and wattmeter.				
DMK15R1 ⓂⓂ	3 phase voltage values 3 phase to phase voltage values 3 phase current values 4 active power values, phase and total 3 maximum phase voltage values 3 maximum phase to phase voltage values 3 maximum phase current values 4 maximum active power values, phase and total 3 minimum phase voltage values 3 minimum phase to phase voltage values 3 minimum phase current values 4 minimum active power values, phase and total	1	1	0.350

Ⓜ Connection also to single-phase.

Ⓜ Relay output for control and protection functions.

General characteristics

The DMK1... instruments are available with flush-mount housing, 96x48mm/3.78x1.89".

Measurements are True RMS values and provide for reliable operation even in the presence of harmonics.

Operational characteristics

- Auxiliary supply voltage: 220...240VAC;
- Operating frequency: 50...60Hz
- True RMS measurements
- Max and min measurement storage
- 1 relay output with 1 changeover contact
- Housing: flush-mount 96x48mm/3.78x1.89"
- Terminals: 4mm²
- Degree of protection: IP54 on front; IP20 at terminals.

DMK10R1

- Voltage measurement range: 15...660VAC
- Operating frequency range: 45...65Hz
- Programmable VT ratio: 1.00...500.00
- Accuracy: ±0.25% f.s. ±1 digit.

DMK11R1

- Current measurement range: 0.05...5.75A
- Operating frequency range: 45...65Hz
- Programmable CT ratio: 5...10,000
- Accuracy: ±0.5% f.s. ±1 digit.

DMK15R1

- Voltage measurement range: 35...660VAC
- Current measurement range: 0.05...5.75A
- Frequency measure range: 45...65Hz
- Programmable VT ratio: 1.00...500.00
- Programmable CT ratio: 5...10,000
- Accuracy: Voltage ±0.25% f.s. ±1 digit
Current ±0.5% f.s. ±1 digit
Power ±1% f.s. ±1 digit.

Control and protection functions

DMK10R1

- Phase loss or failure: OFF/5...85%
- Maximum voltage: OFF/102...120%
- Minimum voltage: OFF/70...98%
- Asymmetry: OFF/2...20%
- Phase sequence: OFF/L1-L2-L3/L3-L2-L1
- Frequency
 - Maximum frequency: OFF/101...110%
 - Minimum frequency: OFF/90...99%
 - Time delay for max-min voltage, phase loss, asymmetry and min-max frequency Ⓜ: 0.5...900.0 seconds.

DMK11R1

- Current loss: OFF/2...100%
- Maximum current: OFF/102...200%
- Maximum current instantaneous tripping: OFF/110...600%
- Minimum current: OFF/5...98%
- Asymmetry: OFF/2...20%
- Time delay for max-min current or current loss and asymmetry Ⓜ: 0.5...900.0 seconds.

DMK15R1

- Voltage
 - Phase loss or failure: OFF/5...85%
 - Maximum voltage: OFF/102...120%
 - Minimum voltage: OFF/70...98%
 - Asymmetry: OFF/2...20%
 - Phase sequence: OFF/L1-L2-L3/L3-L2-L1
- Current
 - Current loss: OFF/5...85%
 - Maximum current: OFF/102...200%
 - Maximum current instantaneous tripping: OFF/110...600%
 - Minimum current: OFF/5...98%
 - Asymmetry: OFF/2...20%
- Power
 - Rated power: 1...10,000
 - Maximum power: OFF/101...200%
 - Max. power instantaneous tripping: OFF/110...600%
 - Minimum power: OFF/10...99%
- Frequency
 - Maximum frequency: OFF/101...110%
 - Minimum frequency: OFF/90...99%
 - Time delay for max-min voltage, max-min current or current loss, phase loss, asymmetry and min-max power Ⓜ: 0.0...900.0 seconds.

Certifications and compliance

Certifications obtained: UL Listed, for USA and Canada (cULus - File E93601), as Auxiliary Devices-Multimeters; EAC. Compliant with standards: IEC/EN/BS 61010-1, IEC/EN/BS 61000-6-2, IEC/EN/BS 61000-6-3, UL 508, CSA C22.2 n° 14.

Ⓜ Independent adjustable delays.

Flush-mount LED multimeter three-phase, non expandable



DMK16R1

Order code	Displayed measurements	Relay output	Qty per pkg	Wt [kg]
DMK16R1 ①	3 phase voltage values 3 phase to phase voltage values 3 phase current values 4 active power values, phase and total 4 reactive power values, phase and total 4 apparent power values, phase and total 3 phase power factor values 1 frequency value 1 active energy value in kWh 1 reactive energy value in kvarh 1 hour counter 3 maximum phase voltage values 3 maximum phase to phase voltage values 3 maximum phase current values 4 maximum active power values, phase and total 4 maximum reactive power values, phase and total 4 maximum apparent power values, phase and total 3 minimum phase voltage values 3 minimum phase to phase voltage values 3 minimum phase current values 4 minimum active power values, phase and total 4 minimum reactive power values, phase and total 4 minimum apparent power values, phase and total 2 minimum and maximum power factor values	1	1	0.353

① Connection also to single-phase.

General characteristics

The DMK16R1 multimeter is available with flush-mount housing, 96x48mm/3.78x1.89"
 Measurements are True RMS values and provide for reliable operation even in the presence of harmonics.

Operational characteristics

- Auxiliary supply voltage: 220...240VAC
- Operating frequency: 50...60Hz
- True RMS measurements
- Accuracy: Voltage $\pm 0.25\%$ f.s. ± 1 digit
 Current $\pm 0.5\%$ f.s. ± 1 digit
- Active energy accuracy: Class 2 (IEC/EN/BS 62053-21 and IEC/EN/BS 62053-23)
- Max and min measurement storage
- Voltage measurement range: 35...660VAC
- Current measurement range: 0.05...5.75A
- Frequency measurement range: 45...65Hz
- Programmable VT ratio: 1.00...500.0
- Programmable CT ratio: 5...10,000
- 1 relay output with 1 changeover (SPDT) contact
- Housing: flush-mount 96x48mm/3.78x1.89"
- Terminals: 4mm²
- EN degree of protection: IP54 on front; IP20 at terminals.

PROGRAMMABLE RELAY OUTPUT

- Voltage
 - Phase loss or failure: OFF/5...85%
 - Maximum voltage: OFF/102...120%
 - Minimum voltage: OFF/70...98%
 - Asymmetry: OFF/2...20%
 - Phase sequence: OFF/L1-L2-L3/L3-L2-L1
- Current
 - Protection inhibition max current: OFF/2...100%
 - Maximum current: OFF/102...200%
 - Maximum current instantaneous tripping: OFF/110...600%
 - Minimum current: OFF/5...98%
 - Asymmetry: OFF/2...20%
- Power factor
 - Maximum power factor: 0.10...1.00
 - Minimum power factor: 0.10...1.00
- Time delay for max-min voltage, max-min current or current loss, phase loss, asymmetry and min-max power factor ②: 0.0...900.0 seconds.

Certifications and compliance

Certifications obtained: UL Listed, for USA and Canada (cULus - File E93601), as Auxiliary Devices-Multimeters; EAC. Compliant with standards: IEC/EN/BS 61010-1, IEC/EN/BS 61000-6-2, IEC/EN/BS 61000-6-3, UL508, CSA C22.2 n° 14.

② Independent adjustable delays.

Communication devices



CX01



CX02



CX03

Order code	Description	Qty per pkg	Wt
		n°	[kg]
CX01	USB/optical device with PC ↔ LOVATO Electric product connecting cable, for programming, data download, diagnostics and firmware upgrade	1	0.090
CX02	Wi-Fi device for PC ↔ LOVATO Electric product programming, data download, diagnostics and cloning	1	0.090
CX03	GSM/GPRS penta-band antenna (850/900/1800/1900/2100MHz)	1	0.090

General characteristics

Communication devices for connection of LOVATO Electric products to personal computers, smartphones and tablets.

CX01

The USB/optical device, complete with cable, allows the connection of products compatible with PCs without having to disconnect the power supply from the electric panel. The PC identifies the connection as a standard USB.

CX02

By Wi-Fi connection, compatible LOVATO Electric products can be viewed on PCs, smartphones and tablets with no need for cabling.

CX03

Antenna compatible with the major part of worldwide mobile networks thanks to the available frequencies at 850/900/1800/1900/2100MHz.

Degree of protection: IP67. Fixing by Ø10mm drilling. Cable length: 2.5mm

Protection covers



PA96X48

Order code	Description	Qty per pkg	Wt
		n°	[kg]
PA96X48	Front protection cover, IEC IP65 for DMK0/1...	1	0.048

General characteristics

When a higher front IP protection degree is needed, the covers can be installed on the corresponding devices and also provide a sealing feature.

Accessories



EXP8000



EXM8004

new

Order code	Description	Qty per pkg	Wt
		n°	[kg]
EXP8000	Plastic insert for customising label fixing for DMG6...	10	0.005
EXM8004	Set of sealable terminal covers for DMG100/110/200/210/300	1	0.020
DMXP03	Panel mounting plate adapter for 3 modules products	1	0.052
DMXP04	Panel mounting plate adapter for 4 modules products	1	0.054



DMXP03



DMXP04

Converter



EXCCON01

Order code	Description	Qty per pkg	Wt
		n°	[kg]
EXCCON01	RS485/Ethernet 12...48VDC converter, including DIN rail fixing kit	1	0.400

General characteristics EXCCON01

The EXCCON01 converter allows "Slave" devices connected on an RS485 network to interface with a "Master" featuring Ethernet port:

- kit comprising converter and DIN rail mounting accessory;
- programming via web interface;
- power supply not included.

Certifications

Certifications obtained: cULus (UL 60950-1) Listed FCC CLASS A.

Gateway



EXCGLA01



EXCGLAX1



EXCM4G01

new

Order code	Description	Qty per pkg	Wt
		n°	[kg]
EXCGLA01	Gateway data logger for the data collecting via Modbus from the device in the field. Publishing of the data to supervision software, also in Cloud	1	0.600
EXCGLAX1	2G/4G modem communication module for EXCGLA01	1	0.160
EXCM4G01	4G Gateway with RS485 and Ethernet port, Modbus RTU/TCP protocol	1	0.300

EXCGLA01 and EXCGLAX1 general characteristics

EXCGLA01 gateway is able to collect data from devices which are connected through Ethernet or RS485 port. Modbus-RTU, ASCII and TCP protocols are supported. The data can be reviewed by a connection to Synergy Cloud service or to Ethernet local webserver and a browser.

The access to internet for data sending can be achieved with Ethernet port or by adding EXCGLAX1 2G/4G modem.

- CPU ARM 1 GHz
- 2 Ethernet ports
- 1 RS232/RS422/RS485 serial port
- 24VDC (10...32VDC) power supply
- Operating temperature -20...+60°C
- Simplified connection to LOVATO Electric devices
- Compatible with Synergy and Synergy cloud software.
- LTE cat. 4 Global support, UMTS/DC HS DPA/HSUPA/WCDMA, GSM/GPRS/EDGE
- SIM slot for microSIM.

Reference standards

Compliant with standards: EN 60950-1.

EXCM4G01 general characteristics

The EXCM4G01 gateway allows "Slave" devices connected on an RS485 network to interface with a "Master" via 4G network:

- TCP server connection via 4G or 2G network;
- Transparent operating mode: the data is transferred from 4G side to serial side and vice versa with Modbus-RTU/TCP protocol conversion;
- Settable parameters: TCP server IP and remote port, network operator apn (with username and password), SIM card pin (with enabling), connection time-out, serial parameters (baud rate from 1,200 bps to 115,200 bps, stop bit, character length, parity)
- Programming via integrated webserver.

Reference standards

Compliant with standards for EXCGLA01: emissions EN/BS 61000-6-4, immunity EN/BS 61000-6-2, for installation in industrial environment.

Compliant with standards for EXCGLAX1: EN/BS 61000-6-4, EN/BS 61000-6-2, EN/BS 61000-6-3, EN/BS 61000-6-1, EN/BS 60945, ETSI EN/BS 301 489-1, ETSI EN/BS 301 489-52, EN/BS 301 511, ETSI EN/BS 301 908-1, ETSI EN/BS 301 908-2, EN/BS 62311, EN/BS 60950-1.

Compliant with standards for EXCM4G01: EN 60950-1.

For dimensions, wiring schemes and technical characteristics, refer to technical instructions in Downloads at www.LovatoElectric.com.

Connecting cable



51C2

Order code	Description	Qty per pkg.	Wt
		n°	[kg]
51C2	For PC-multimeter RS232 port, 1.8m long	1	0.090

Wound primary type



DMOTW...

new

Order code	Primary current I _{pn}	Burden			Qty per pkg	Wt [kg]
		cl. 0.5 [VA]	cl. 1 [VA]	cl. 3 [VA]		
	/5 [A]	[VA]	[VA]	[VA]	n°	[kg]

Screw primary terminals.

DMOTW0005	5	1.5	2.5	—	1	0.525
DMOTW0010	10	1.5	2.5	—	1	0.525
DMOTW0020	20	1.5	2.5	—	1	0.525
DMOTW0030	30	1.5	2.5	—	1	0.525

Solid-core



DMOT...

new

Order code	Primary current I _{pn}	Burden			Qty per pkg	Wt [kg]
		cl. 0.5 [VA]	cl. 1 [VA]	cl. 3 [VA]		
	/5 [A]	[VA]	[VA]	[VA]	n°	[kg]

For Ø22mm/0.87" cable.

DMOT0040	40	—	—	1.25	1	0.200
DMOT0050	50	—	1.25	—	1	0.200
DMOT0060	60	—	1.5	—	1	0.200
DMOT0080	80	—	1.5	—	1	0.200
DMOT0100	100	—	1.5	—	1	0.200
DMOT0150	150	—	2	—	1	0.200



DM2T...

Order code	Primary current I _{pn}	Burden		Qty per pkg.	Wt [kg]
		cl. 0.5 [VA]	cl. 1 [VA]		
	/5 [A]	[VA]	[VA]	n°	[kg]

For Ø23mm/0.90" cable.

For 30x10mm/1.18x0.39", 25x12.5mm/0.98x0.49", 20x15mm/0.79x0.59" busbars, width 52mm/2.05".

DM2T0100	100	—	1	1	0.130
DM2T0150	150	—	1.5	1	0.130
DM2T0200	200	—	2	1	0.130
DM2T0250	250	—	2.5	1	0.130
DM2T0300	300	1.5	3	1	0.130
DM2T0400	400	2	3	1	0.130

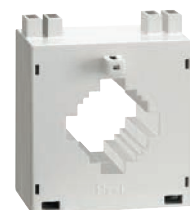

DM3T...

For Ø30mm/1.18" cable.

For 40x10mm/1.57x0.39", 30x20mm/1.18x0.79", 25x25mm/0.98x0.98" busbars, width 71mm/2.79".

DM3T0200	200	—	5	1	0.260
DM3T0250	250	—	5	1	0.260
DM3T0300	300	2.5	5	1	0.260
DM3T0400	400	2.5	5	1	0.260
DM3T0500	500	2.5	5	1	0.260
DM3T0600	600	5	10	1	0.260
DM3T0800	800	5	10	1	0.260

For Ø44mm/1.73" cable.

For 51x41mm/2.01x1.61", 61x31mm/2.40x1.22" busbars, width 95mm/3.74".

new

DM33T0800	800	5	10	1	0.476
DM33T1000	1000	5	15	1	0.476
DM33T1200	1200	5	15	1	0.476

For Ø44mm/1.73" cable.

For 69x10mm/2.72x0.39", 50x30mm/1.97x1.18" busbars, width 95mm/3.74".

new

DM34T1500	1500	5	15	1	0.476
DM34T1600	1600	5	15	1	0.476

General characteristics

The current transformers (CTs) in the DM series are installed in an electrical system to reduce the line current to a secondary value of 5A compatible with the ammeter inputs of the digital multimeters or protection relays.

DMOTW... are instrument transformers in class 1/0.5 wound primary type and are normally used for low primary current values starting from 5A.

DM... are instrument transformers in class 1/0.5 without a primary winding and are normally used for high primary current values starting from 40A.

The number of loops of the primary cable does not modify the accuracy but converts the primary current value proportional to secondary current.

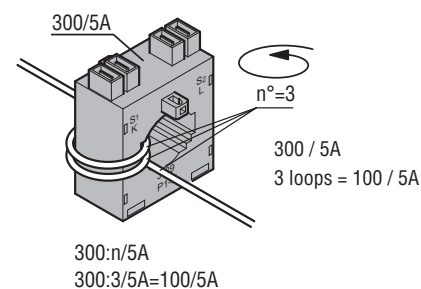
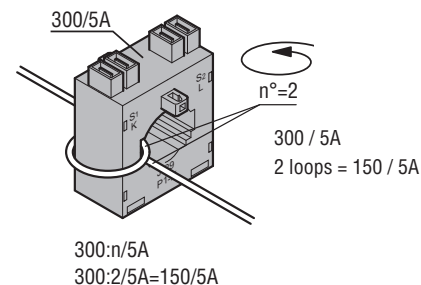
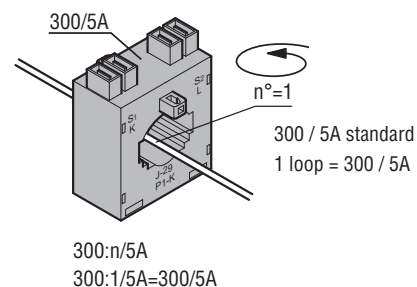

Operational characteristics

- Operating frequency: 50...60Hz
- Secondary output current: 5A
- Overload withstand: 120% I_{pn}
- IEC rated insulation voltage U_i: 720V
- IEC rated short-time thermal current I_{th}: 40...60 I_{pn} for 1 second
- IEC rated dynamic current I_{dyn}: 2.5 I_{th} for 1 second
- Insulation (dry type): Class E
- Terminals:

- Faston for DM2T... and DM3T... types
- Screw for DMOT... types
- Sealable terminal covers for DM4T..., DM33T, DM34T and DM35T... types
- Fixing on 35mm DIN rail (IEC/EN/BS 60715) or by screws (fixing elements standard supplied with the product)
- EN degree of protection: IP30
- Ambient conditions:
 - Operating temperature: -25...+50°C
 - Storage temperature: -40...+80°C
 - Relative humidity, non condensing: 90%.

Certifications and compliance

Certifications obtained: EAC.
Compliant with standards: IEC/EN/BS 61869-2, IEC/EN/BS 61869-1.

Solid-core



DM35T...



DM4T...

new

new

Order code	Primary current I _{pn}	Burden		Qty per pkg.	Wt [kg]
		cl. 0.5 [VA]	cl. 1 [VA]		

For Ø66mm/2.60" cable.
For 80x12,5mm/3.15"x0.49", 60x30mm/2.36x1.18", 50x50mm/1.97x1.97" busbars, width 105mm/4.13".

DM35T0400	400	—	5	1	0.460
DM35T0500	500	5	5	1	0.460
DM35T0600	600	5	10	1	0.460
DM35T0800	800	10	15	1	0.460
DM35T1000	1000	15	20	1	0.460
DM35T1250	1250	15	20	1	0.460

For 101x56mm/3.98x2.20" busbars, width 128mm/5.04".

DM37T2000	2000	10	15	1	1.000
DM37T2250	2250	10	15	1	1.000
DM37T2500	2500	10	15	1	1.000
DM37T3000	3000	10	15	1	1.000

For Ø86mm/3.38" cable.
For 100x30mm/3.94x1.18", 80x50mm/3.15x1.97", 70x60mm/2.75x2.36" busbars, width 140mm/5.51".

DM4T1000	1000	10	20	1	0.700
DM4T1250	1250	15	30	1	0.760
DM4T1500	1500	20	30	1	0.760
DM4T1600	1600	20	30	1	0.800
DM4T2000	2000	30	45	1	0.840
DM4T2500	2500	35	45	1	0.900
DM4T3000	3000	45	45	1	0.900
DM4T3500	3500	50	50	1	0.900
DM4T4000	4000	50	50	1	0.900

General characteristics

The current transformers (CTs) in the DM series are installed in an electrical system to reduce the line current to a secondary value of 5A compatible with the ammeter inputs of the digital multimeters or protection relays.

DM... are instrument transformers in class 1/0.5 without a primary winding and are normally used for high primary current values starting from 50A.

The number of loops of the primary cable does not modify the accuracy but converts the primary current value proportional to secondary current.

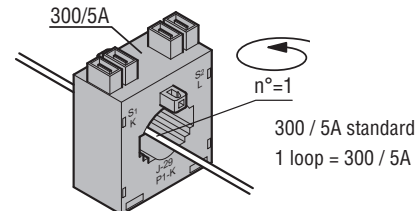

300:n/5A
300:1/5A=300/5A

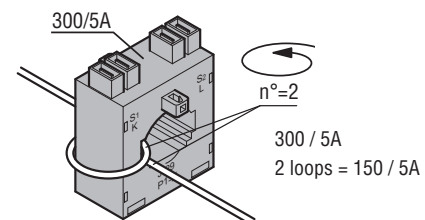

300:n/5A
300:2/5A=150/5A

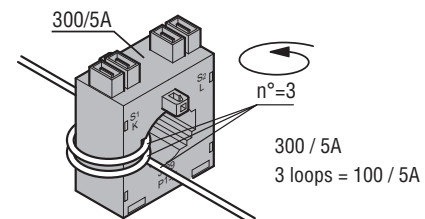

300:n/5A
300:3/5A=100/5A

Operational characteristics

- Operating frequency: 50...60Hz
- Secondary output current: 5A
- Overload withstand: 120% I_{pn}
- IEC rated insulation voltage U_i: 720V
- IEC rated short-time thermal current I_{th}: 40...60 I_{pn} for 1 second
- IEC rated dynamic current I_{dyn}: 2.5 I_{th} for 1 second
- Insulation (dry type): Class E
- Terminals:
 - Screw for DM4T... and DM35T... types
- Sealable terminal covers for DM4T..., DM35T... and DM37T... types
- Fixing on 35mm DIN rail (IEC/EN/BS 60715) or by screws (fixing elements standard supplied with the product)
- EN degree of protection: IP30
- Ambient conditions:
 - Operating temperature: -25...+50°C
 - Storage temperature: -40...+80°C
 - Relative humidity, non condensing: 90%.

Certifications and compliance

Certifications obtained: EAC.
Compliant with standards: IEC/EN/BS 61869-2, IEC/EN/BS 61869-1.

Accuracy solid-core



DM1TP...



DM3TP...



DM4TP...

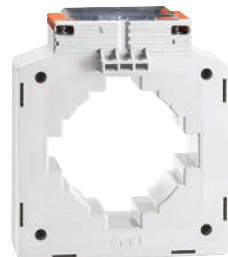

DM5TP...

Version with UTF certificates.
See page 25-17.

Order code	Primary current I _{pn}	Burden		Qty per pkg	Weight [kg]
		cl. 0.5s [VA]	cl. 0.5 [VA]		

For Ø28mm/1.10" cable.
For 30x10mm/1.18x0.39", 25x12.5mm/0.98x0.49", 20x20mm/0.79x0.79" busbar, width: 75mm/2.95".

DM1TP0060	60	1.5	1.5	1	0.560
DM1TP0080	80	2.5	2.5	1	0.580
DM1TP0100	100	2.5	3.75	1	0.480
DM1TP0150	150	2.5	3.75	1	0.480
DM1TP0200	200	2.5	3.75	1	0.480
DM1TP0250	250	2.5	5	1	0.480
DM1TP0300	300	2.5	5	1	0.480
DM1TP0400	400	5	5	1	0.480
DM1TP0500	500	5	5	1	0.480

For Ø28mm/1.10" cable.
For 30x10mm/1.18x0.39", 25x20mm/0.98x0.79", 20x20mm/0.79x0.79" busbar, width: 75mm/2.95".

new

DM1TP0600	600	2.5	5	1	0.480
-----------	-----	-----	---	---	-------

For Ø52mm/2.04" cable.
For 60x20mm/2.36x0.79", 50x25mm/1.97x0.98" busbar, width: 101mm/3.98".

DM3TP0500	500	3.75	5	1	0.700
DM3TP0600	600	5	10	1	0.700
DM3TP0800	800	5	10	1	0.700
DM3TP1000	1000	5	10	1	0.700

new

For Ø80mm/3.15" cable.
For 82x30mm/3.23x1.18" busbar, width: 128mm/5.04".

DM4TP1200	1200	-	10	1	0.800
-----------	------	---	----	---	-------

For Ø85.5mm/3.37" cable.
For 100x20mm/3.94x0.79", 80x45mm/3.15x1.77" busbar, width: 144mm/5.67".

DM5TP1000	1000	5	10	1	0.900
DM5TP1250	1250	7.5	10	1	0.900
DM5TP1600	1600	7.5	10	1	0.900
DM5TP2000	2000	10	15	1	0.900
DM5TP2500	2500	10	15	1	0.900
DM5TP3000	3000	10	15	1	0.900

Consult Technical support to inquiry about versions with Italian UTF certificates.

General characteristics

The DM...TP type accuracy current transformers (CTs) are installed in an electrical system to reduce the line current to a secondary value of 5A compatible with the ammeter inputs of the digital multimeters or protection relays.

DM...TP are accuracy current transformers in class 0.5s without a primary winding and are normally used for high primary current values starting from 60A.

The number of loops of the primary cable does not modify the accuracy but converts the primary current value proportional to secondary current.

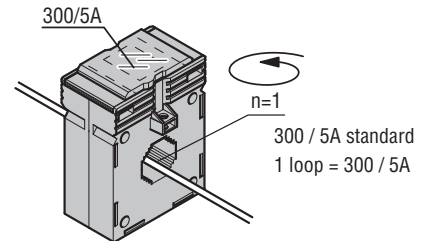

300:n/5A
300:1/5A=300/5A

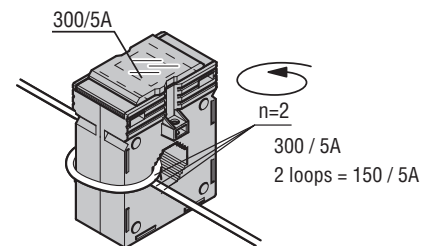

300:n/5A
300:3/5A=100/5A

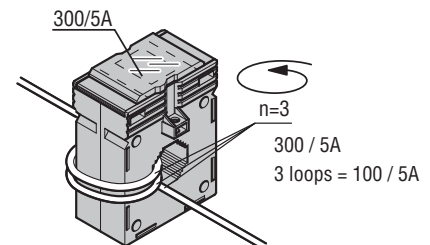

300:n/5A
300:3/5A=100/5A

Operational characteristics

- Operating frequency: 50...60Hz
- Secondary output current: 5A
- Overload withstand: 120% I_{pn}
- IEC rated insulation voltage U_i: 720V
- IEC rated short-time thermal current I_{th}: 40...60 I_{pn} for 1 second
- IEC rated dynamic current I_{dyn}: 2.5 I_{th} for 1 second
- Insulation (dry type): Class E
- Screw terminals
- Sealable terminal covers
- Fixing on 35mm DIN rail (IEC/EN/BS 60715) or by screws (fixing elements standard supplied with the product)
- EN degree of protection: IP30
- Ambient conditions:
 - Operating temperature: -25...+50°C
 - Storage temperature: -40...+80°C
 - Relative humidity, non condensing: 90%.

Certifications and compliance

Certifications obtained: EAC.
Compliant with standards: IEC/EN/BS 61869-2, IEC/EN/BS 61869-1.

Compact prewired split-core



DM1TMA...



DM2TMA...

new

Order code	Primary current I _{pn} [A]	Burden		Qty per pkg. n°	Weight [kg]
		cl. 0.5 [VA]	cl. 1 [VA]		
24x24mm/0.94x0.94" hole. Cable supplied as standard, length 2m.					
DM1TMA0100	100	—	1.0	1	0.200
DM1TMA0150	150	—	1.0	1	0.200
DM1TMA0200	200	—	1.0	1	0.200
DM1TMA0250	250	—	1.0	1	0.200
36x38mm/1.42x1.50" hole. Cable supplied as standard, length 2m.					
DM2TMA0250	250	0.5	1.5	1	0.380
DM2TMA0300	300	0.5	1.5	1	0.380
DM2TMA0400	400	0.5	1.5	1	0.380
DM2TMA0500	500	0.5	1.5	1	0.380
DM2TMA0600	600	0.5	1.5	1	0.380

General characteristics

The DM...TMA type current transformers (CTs) are installed in an electrical system to reduce the line current to a secondary value of 5A compatible with the ammeter inputs of the digital multimeters or protection relays.

DM...TMA are instrument transformers in class 1 without a primary winding and are normally used for high primary current values starting from 100A.

Operational characteristics

- Operating frequency: 50...60Hz
- Secondary output current: 5A
- Overload withstand: 120% I_{pn}
- IEC rated insulation voltage U_i: 720V
- IEC rated short-time thermal current I_{th}: 40...60 I_{pn} for 1 second
- IEC rated dynamic current I_{dyn}: 2.5 I_{th} for 1 second
- Cable supplied as standard, length 2m.
- Insulation (dry type): Class E
- Ambient conditions:
 - Operating temperature: -25...+50°C
 - Storage temperature: -40...+80°C
 - Relative humidity, non condensing: 90%.

Certifications and compliance

Certifications obtained: EAC.
Compliant with standards: IEC/EN/BS 61869-2, IEC/EN/BS 61869-1.

Split-core



DM1TA...

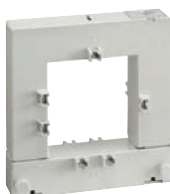

DM2TA...



DM3TA...



DM4TA...

new

new

new

Order code	Primary current I _{pn}	Burden			Qty per pkg	Wt [kg]
		cl. 0,5	cl. 1	cl. 3		

32x21mm/1.26x0.83" hole. Width: 89mm/3.50".

DM0TA0100	100	—	—	1	1	0.900
DM0TA0150	150	—	1	2.5	1	0.900
DM0TA0200	200	—	2.5	—	1	0.900

50x80mm/1.97x3.15" hole. Width: 114mm/4.89".

DM1TA0250	250	1	2		1	0.900
DM1TA0300	300	1.5	3		1	0.900
DM1TA0400	400	1.5	3		1	0.900
DM1TA0500	500	2.5	5		1	0.900
DM1TA0600	600	2.5	5		1	0.900
DM1TA0800	800	3	7.5		1	0.900
DM1TA1000	1000	5	10		1	0.900

Order code	Primary current I _{pn}	Burden		Qty per pkg	Wt [kg]
		cl. 0.5s	cl. 0.5		

80x80mm/3.15x3.15" hole. Width: 142mm/5.59".

DM2TA0250	250	1	2	1	1.050
DM2TA0300	300	1.5	3	1	1.050
DM2TA0400	400	1.5	3	1	1.050
DM2TA0500	500	2.5	5	1	1.050
DM2TA0600	600	2.5	5	1	1.050
DM2TA0800	800	3	7.5	1	1.050
DM2TA1000	1000	5	10	1	1.050
DM2TA1250	1250	—	15	1	1.050

80x120mm/3.15x4.72" hole. Width: 142mm/5.59".

DM3TA0500	500	—	4	1	1.250
DM3TA0600	600	—	5	1	1.250
DM3TA0800	800	3	7.5	1	1.250
DM3TA1000	1000	5	10	1	1.250
DM3TA1250	1250	7.5	15	1	1.250
DM3TA1500	1500	8	17	1	1.250
DM3TA2000	2000	—	17	1	1.250

80x160mm/3.15x6.30" hole. Width: 184mm/7.24".

DM4TA2000	2000	15	20	1	3.160
DM4TA2500	2500	15	20	1	3.340
DM4TA3000	3000	20	25	1	3.500
DM4TA4000	4000	20	25	1	3.760

General characteristics

The DM...TA type current transformers (CTs) are installed in an electrical system to reduce the line current to a secondary value of 5A compatible with the ammeter inputs of the digital multimeters or protection relays.

DM...TA are instrument transformers in class 0.5/1 without a primary winding and are normally used for high primary current values starting from 250A.

Operational characteristics

- Operating frequency: 50...60Hz
- Secondary output current: 5A
- Overload withstand: 120% I_{pn}
- IEC rated insulation voltage U_i: 720V
- IEC rated short-time thermal current I_{th}: 40...60 I_{pn} for 1 second
- IEC rated dynamic current I_{dyn}: 2.5 I_{th} for 1 second
- Insulation (dry type): Class E
- Screw terminals
- Sealable terminal covers
- Screw fixing (fixing elements standard supplied with the product)
- IEC degree of protection: IP30
- Ambient conditions:
 - Operating temperature: -25...+50°C
 - Storage temperature: -40...+80°C.
 - Relative humidity, non condensing: 90%.

Certifications and compliance

Certifications obtained: EAC.

Compliant with standards: IEC/EN/BS 61869-2, IEC/EN/BS 61869-1.

CURRENT TRANSFORMERS
Wound primary **DM0TW...**

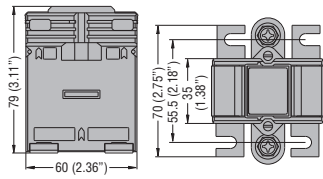

Solid core **DM0T...**

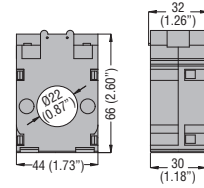

DM2T...

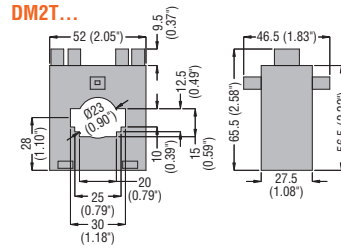

DM3T...

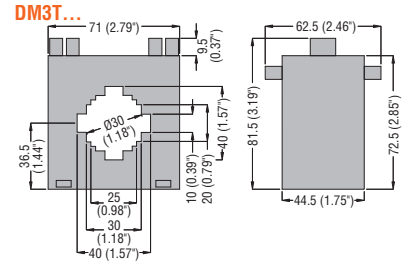

DM33T...

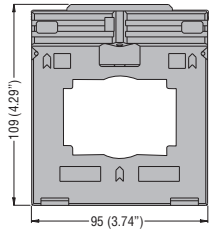

DM34T...

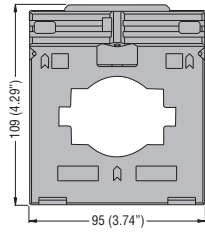

DM35T...

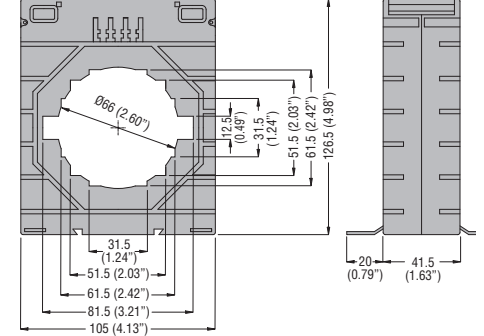

DM37T...

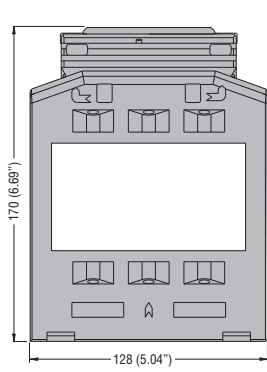

DM4T...

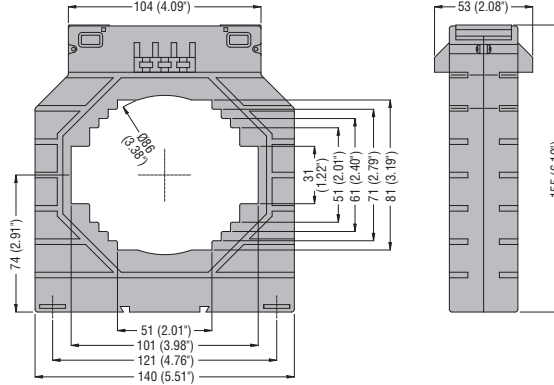

DM1TP0060... - DM1TP0300

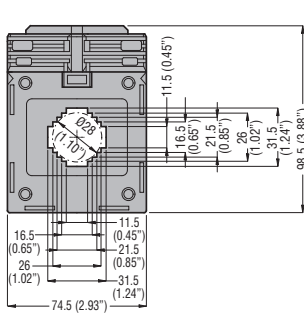

DM1TP0400... - DM1TP0600

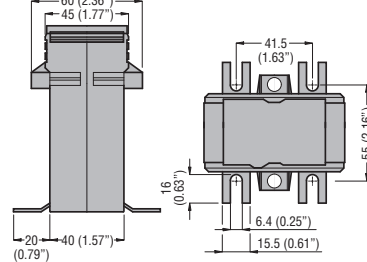
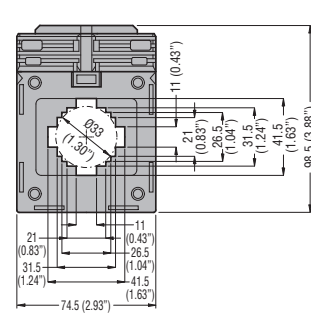

DM3TP...

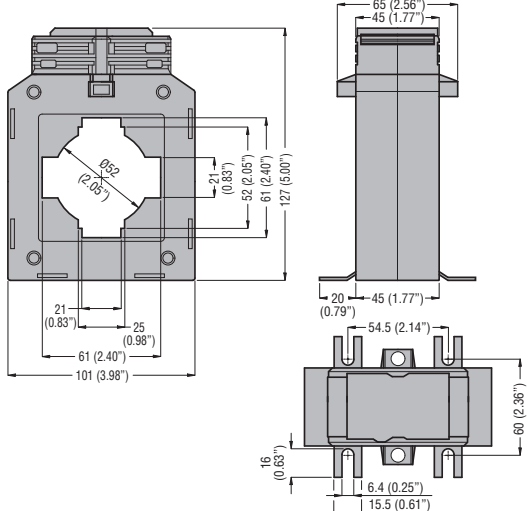

DM4TP1200

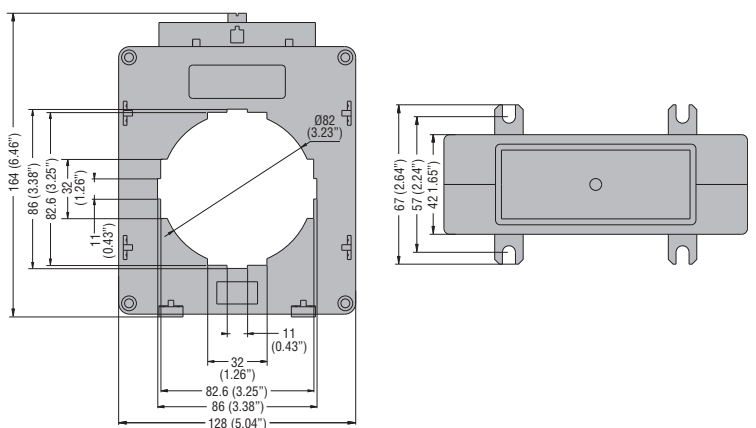

DM5TP...

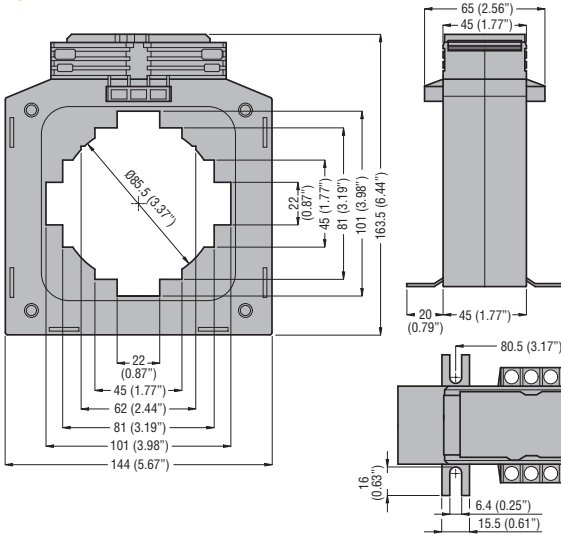

Compact prewired split-core

DM1TMA...

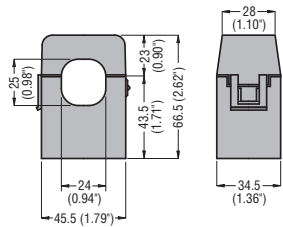

DM2TMA...

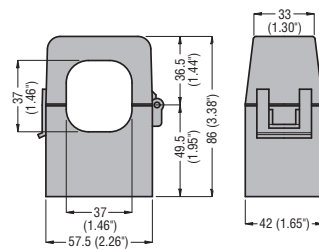

Split-core

DM0TA...

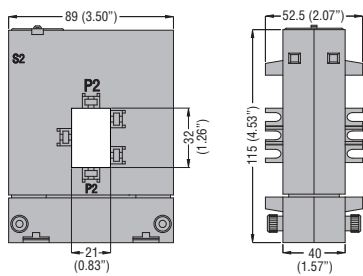

DM1TA...

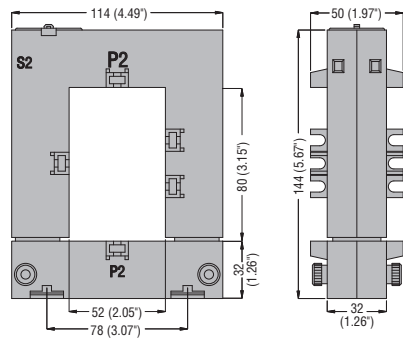

DM2TA...

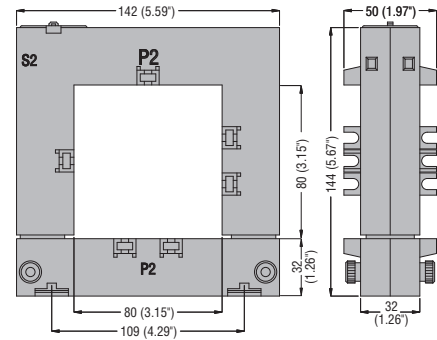

DM3TA...

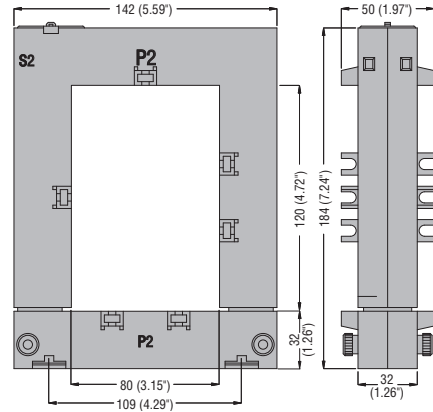

DM4TA...

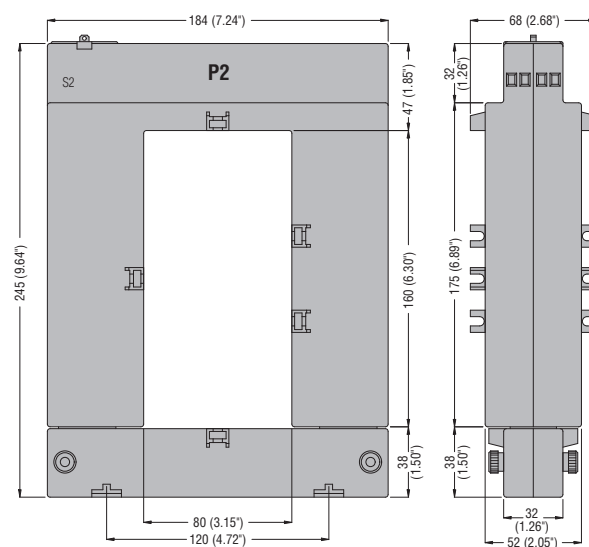

ENERGY METERS

DMED111...

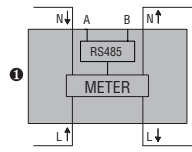

DMED112...

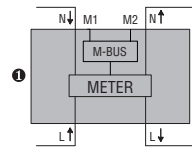

1 110-240VAC DMED111, DMED112...

Digital meters DMED100T1... - DMED110T1...

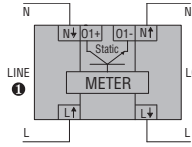

DMED115T1 - DMED120T1...

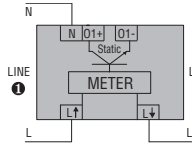

DMED121...

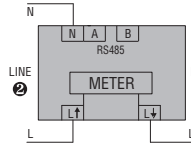

DMED122...

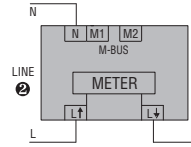

DMED130LM

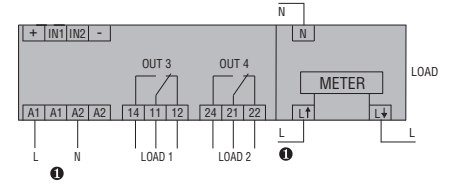

1 110-120VAC DMED...A120; 220-240VAC DMED...; 230V 50Hz DMED... T1 MID.
2 110-240VAC DMED121, DMED122...

DMED300T2... - DMED300F

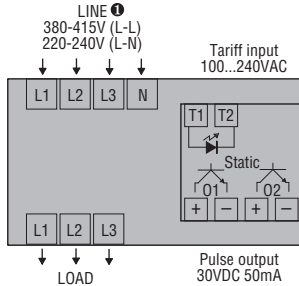

DMED310T2... - DMED310F...

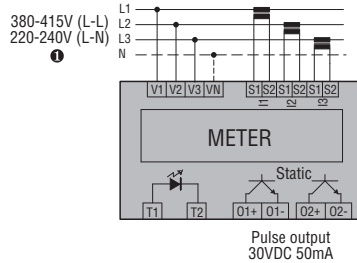

DMED301

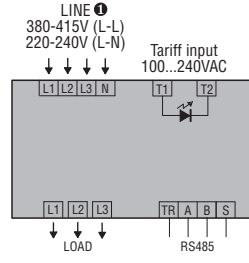

DMED302

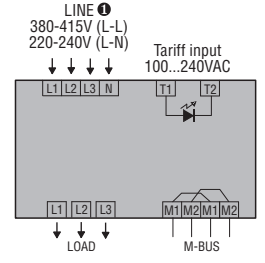

1 230V 50Hz (L-N), 400V 50Hz (L-L) DMED... T2 MID / DMED... F.

DMED305T2 - DMED330 - DMED332

Single-phase

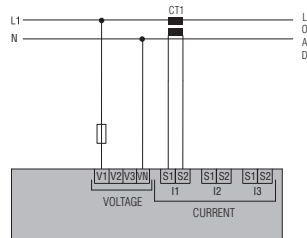

Two-phase

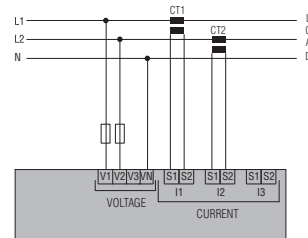

Three-phase with or without neutral

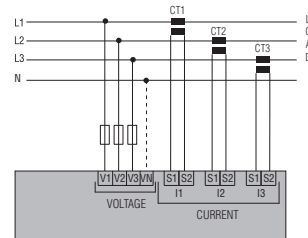

Three-phase without neutral in ARON connection

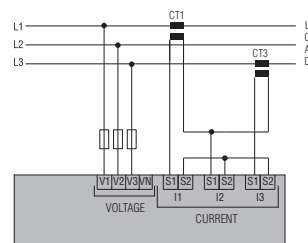
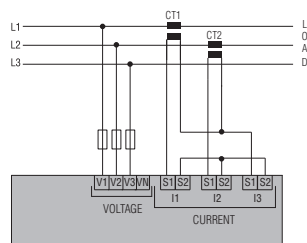

Tariff input



Pulse output 30VDC 50mA for DMED305T2

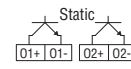

RS485 for DMED330



M-BUS for DMED332

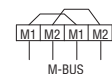

Data concentrator DMECD

100...240VAC
110...250VDC

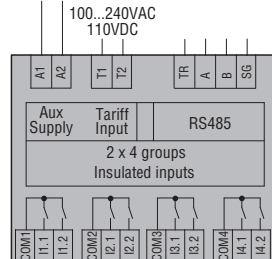

MULTIMETERS **DMG...** Single-phase

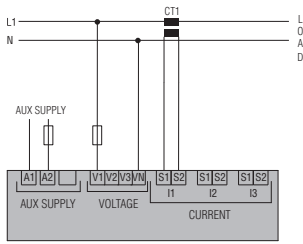

Two-phase

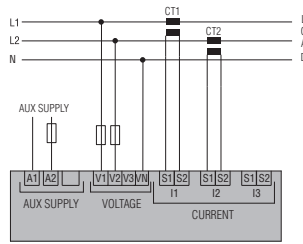

Three-phase with or without neutral

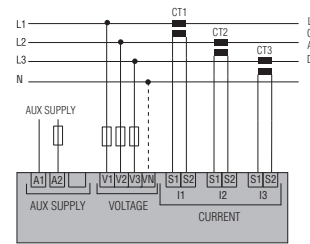

Three-phase without neutral in ARON connection

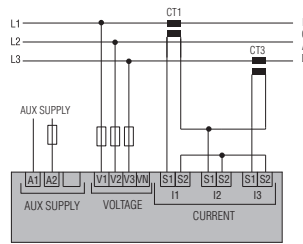
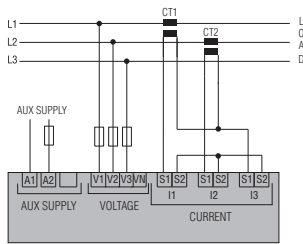

Balanced 3-phase connection with or without neutral

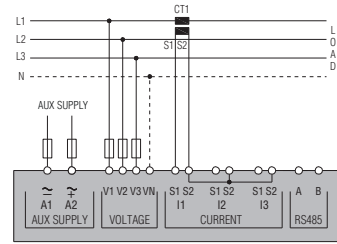

CODE	AUX SUPPLY
DMG100-110-200-210-300	100...240VAC 110...250VDC
DMG6...	100...440VAC 110...250VDC
DMG7000-7500-8000-9000	100...240VAC 110...250VDC

RS485 for DMG110 and DMG210



RS485 for DMG610



RS485 for DMG7500 and DMG9000



MULTIMETERS **DMG611...**

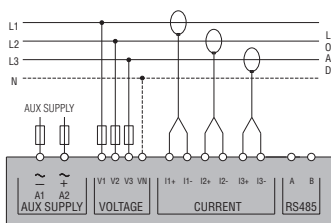

RS485 for DMG611



METERING INSTRUMENTS
DMK80R1

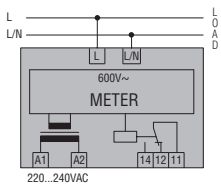

DMK81R1

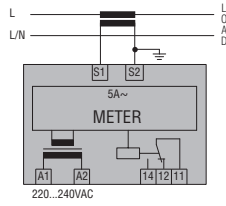

DMK70R1

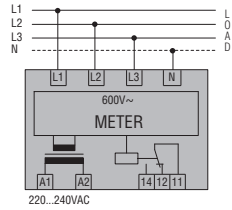

DMK71R1

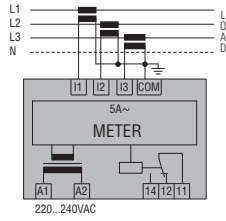

DMK75R1

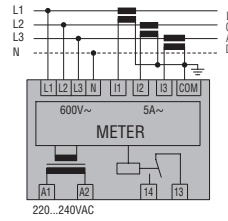

DMK00R1

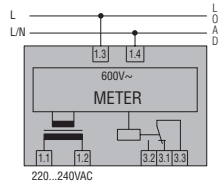

DMK01R1

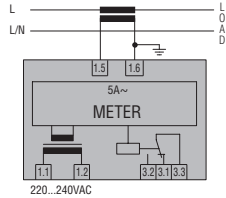

DMK02
Voltmeter

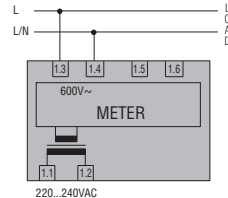

Ammeter

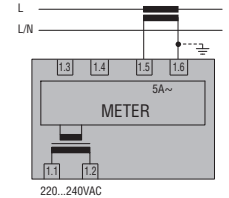

DMK10R1

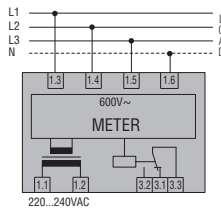

DMK11R1

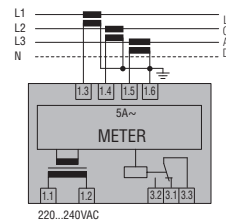

DMK15R1

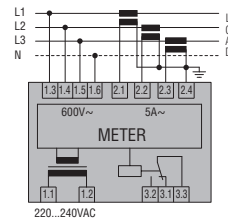

DMK16R1

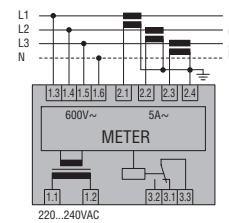

25 Metering instruments and current transformers

Technical characteristics
Single-phase energy meters



INDEX

TYPE	DMED100T1	DMED100T1A120	DMED100T1MID	DMED110T1	DMED110T1A120	
	Single-phase	Single-phase	Single-phase	Single-phase	Single-phase	
AUXILIARY SUPPLY						
Rated voltage(Ue)	220...240VAC	110...120VAC	230VAC	220...240VAC	110...120VAC	
Operating voltage range	187...264VAC	93...132VAC	187...264VAC	187...264VAC	93...132VAC	
Rated frequency	50/60Hz	60Hz	50Hz	50/60Hz	60Hz	
Maximum power consumption			7VA			
Maximum power dissipation			0.45W			
CURRENT						
IEC maximum current (Imax)			40A			
IEC minimum current (Imin)			0,25A			
IEC rated current (Iref-Ib)			5A			
IEC start current (Ist)			20mA			
Transition current (Itr)			0,5A			
ACCURACY						
Active energy (per IEC/EN/BS 62053-21)	Class 1		Class B (EN 50470-3)	Class 1		
OUTPUTS						
LED rate			1000 flash/kWh			
Pulse rate			1000 pulses/kWh			
Pulse duration			30ms			
STATIC OUTPUTS						
Pulse rate	10 pulses/kWh			1-10-100-1000 pulses/kWh programmable		
Pulse duration			100ms			
External voltage			10...30VDC			
Maximum current			50mA			
INSULATION						
IEC rated insulation voltage Ui			250VAC			
IEC rated impulse withstand voltage Uimp			6kV			
IEC power frequency withstand voltage			4kV			
SUPPLY/MEASUREMENT CONNECTION CIRCUIT						
Type of terminals			Fixed			
Conductor section (min...max)			1.5...10mm ² (16...6AWG)			
Maximum tightening torque			1.5Nm (14lb.in)			
CONNECTION (PULSE OUTPUT/RS485/MBUS)						
Type of terminals			Fixed			
Conductor section (min...max)			0.2...4mm ² (24...12AWG)			
Maximum tightening torque			0.8Nm (7lb.in)			
AMBIENT CONDITIONS						
Operating temperature			-25...+55°C			
Storage temperature			-25...+70°C			
Relative humidity			<80%			
Maximum pollution degree			2			
Mechanical environment	-	-	Class M1	-	-	
Magnetic environment	-	-	Class E1	-	-	
HOUSING						
Material			Polyamide			

25 Metering instruments and current transformers

Technical characteristics
Single-phase energy meters

DMED111/112	DMED110T1MID DMED111MID/MID7 DMED112MID	DMED115T1	DMED120T1	DMED120T1A120	DMED120T1MID DMED121MID DMED122MID	DMED121	DMED130LM DMED122
Single-phase	Single-phase	Single-phase	Single-phase	Single-phase	Single-phase	Single-phase	Single-phase
110...240VAC	230VAC	220...240VAC	220...240VAC	110...120VAC	230VAC	110...240VAC	220...240VAC
93...264VAC	187...264VAC	187...264VAC	187...264VAC	93...132VAC	187...264VAC	88...264VAC	187...264VAC
50/60Hz	50Hz	50/60Hz	50/60Hz	60Hz	50Hz	50/60Hz	
1VA	7VA	7VA			4.8VA		4.8VA
0.4W	0.45W	0.45W			1.4W		1.4W
40A		40A	63A			63A	
0.25A		0.5A			0.5A		0.5A
5A		10A			10A		10A
20mA		40mA			40mA		40mA
0.5A		1A			1A		1A
Class 1/B	Class B (EN 50470-3)	Class 1			Class B (EN 50470-3)	Class 1	
1000 flash/kWh		1000 flash/kWh			1000 flash/kWh		1000 flash/kWh
1000 pulses/kWh		1000 pulses/kWh			1000 pulses/kWh		1000 pulses/kWh
30ms		30ms			30ms		30ms
1-10-100-1000 pulses/kWh programmable (only for DMED...T1...)		1-10-100-1000 pulses/kWh programmable (only for DMED...T1...)			-		-
100ms		100ms			-		-
10...30VDC		10...30VDC			-		-
50mA		50mA			-		-
250VAC		250VAC			250VAC		250VAC
6kV		6kV			6kV		6kV
4kV		4kV			4kV		4kV
Fixed		Fixed			Fixed		Fixed
1.5...10mm ² (16...6AWG)		2.5...16mm ² (14...6AWG; 14...10AWG)			2.5...16mm ² (14...6AWG; 14...10AWG)		2.5...16mm ² (14...6AWG; 14...10AWG)
1.5Nm (14lb.in)		2Nm (26.5lb.in)			2Nm (26.5lb.in)		2Nm (26.5lb.in)
Fixed		Fixed			Fixed		Fixed
0.2...4mm ² (24...12AWG)		0.5...4mm ² (20...11AWG)			0.5...4mm ² (20...11AWG)		0.5...4mm ² (20...11AWG)
0.8Nm (7lb.in)		1.3Nm (12.1lb.in)			1.3Nm (12.1lb.in)		1.3Nm (12.1lb.in)
		-25...+55°C (MID7: -25...+70°C)					
-25...+70°C		-25...+70°C			-25...+70°C		-25...+70°C
<80%		<80%			<80%		<80%
2		2			2		2
Class M1		-	-	-	Class M1	-	-
Class E1		-	-	-	Class E1	-	-
Polyamide		Polyamide			Polyamide		Polyamide

25 Metering instruments and current transformers

Technical characteristics
Three-phase energy meters



INDEX

TYPE	DMED300T2... DMED301... DMED302	DMED300T2MID DMED301MID/MID7 DMED300MID	DMED310T2 DMED305T2	DMED310T2MID DMED305T2MID	DMED330 DMED332	DMED330MID DMED332MID
	3 phase with neutral	3 phase with neutral	3 phase with and without neutral	3 phase with neutral	3 phase with and without neutral	3 phase with neutral
AUXILIARY SUPPLY						
Rated voltage (Ue)	380...415VAC (3ph-N) DMED...UL: 120VAC (LN) - 240VAC (L-L)	400VAC (3ph-N)	380...415VAC (3ph-N)	400VAC (3ph-N)	380...415VAC (3ph-N)	400VAC (3ph-N)
Voltage range	187...264VAC phase-neutral / 323...456VAC phase-phase					
Rated frequency	50/60Hz (UL: 60Hz)	50Hz	50/60Hz	50Hz	50/60Hz	50Hz
Maximum power consumption	20VA		3.5VA		3.5VA	
Maximum power dissipation	1.35W		2.7W		2.7W	
CURRENT						
IEC maximum current (Imax)	80A		5A		5A	
IEC minimum current (Imin)	0.75A		0.05A		0.05A	
IEC rated current (Iref-Ib)	15A		5A		5A	
IEC start current (Ist)	60mA		0.005A		0.005A	
IEC transition current (Itr)	1.5A		0.25A		0.25A	
ACCURACY						
Active energy (per IEC/EN/BS 62053-21)	Class 1	Class B (EN50470-3)	Class 0.5s DMED305T2 Class 1 DMED310T2	Class B (EN50470-3)	Class 0.5s	Class B (EN50470-3)
TARIFF CIRCUIT INPUT						
Rated voltage (Uc)	100...240VAC					
Voltage range	85...264VAC					
Frequency	50/60Hz					
Maximum power consumption	0.25VA					
Maximum power dissipation	0.18W					
LED						
Pulse rate	1000 pulses/kWh					
Pulse duration	30ms					
STATIC OUTPUTS						
Pulse rate	1-10-100-1000 pulses/kWh programmable (except DMED301/302)		0.1-1-10-100 pulses/kWh programmable		—	
Pulse duration	100ms for 1-10-100 pulses (except DMED301/302) 60ms for 1000 pulses (except DMED301/302)		100ms		—	
External voltage	10...30VDC (except DMED301/302)		10...30VDC		—	
Maximum current	50mA (except DMED301/302)		—		—	
INSULATION						
IEC rated insulation voltage Ui	250VAC					
IEC rated impulse withstand voltage Uimp	6kV					
IEC power frequency withstand voltage	4kV					
SUPPLY/MEASUREMENT CIRCUIT CONNECTIONS						
Type of terminals	Fixed		Fixed			
Conductor section (min...max)	2.5...16mm ² (16...6AWG)		0.2...4mm ² (24...12AWG) for supply/voltage measurement; 0.2...2.5mm ² (24...12AWG) for current measurement			
Maximum tightening torque	2Nm (14lb.in)		0.8Nm (7lb.in)			
TARIFF CONTROL CIRCUIT CONNECTIONS						
Type of terminals	Fixed		Fixed			
Conductor section (min...max)	0.2...2.5mm ² (24...12AWG)		0.2...4mm ² (24...12AWG)			
Maximum tightening torque	0.49Nm (4.4lb.in)		0.8Nm (7lb.in) (0.44Nm / 4lb.in for current measurement DMED320)			
CONNECTIONS (PULSE OUTPUT/RS485)						
Type of terminals	Fixed		Fixed			
Conductor section (min...max)	0.2...1.3mm ² (24...16AWG)		0.2...2.5mm ² (24...12AWG)			
Maximum tightening torque	0.15Nm (1.7lb.in)		0.44Nm (4lb.in)			
AMBIENT CONDITIONS						
Operating temperature	-25...+55°C					
Storage temperature	-25...+70°C					
Relative humidity	<80% non condensing					
Maximum pollution degree	2		2		2	
Mechanical environment	— Class M1		— Class M1		— Class M1	
Magnetic environment	— Class E1		— Class E1		— Class E1	
HOUSING						
Material	Polyamide		Polyamide			

TYPE	DMECD
AUXILIARY SUPPLY	
Rated voltage (Us)	100...240VAC/110...250VDC
Voltage range	85...264VAC/93.5...300VDC
Rated frequency	50/60Hz
Maximum power consumption	8.8VA
Maximum power dissipation	3.6W
ENERGY METER INPUTS	
Number of inputs	8
Input separations	1 common for every 2 inputs (insulated between each pair 500VRMS)
Type of input	Negative (NPN)
Maximum voltage at inputs	15VDC
Maximum input current	18mA (15mA typical)
High input signal	≥7.6V
Low input signal	≤2V
Maximum frequency	2000Hz
TARIFF CONTROL CIRCUIT	
Rated voltage (Uc)	100...240VAC/110VDC
Voltage range	85...264VAC/93.5...140VDC
Frequency	50/60Hz
Maximum power consumption	0.25VA
Maximum power dissipation	0.18W
RS485 SERIAL INTERFACE	
Baud-rate	Programmable 1200...38400bps
Insulation	1500VAC towards energy meter inputs. Double insulation towards supply and tariff inputs
INSULATION	
IEC rated insulation voltage Ui	250VAC
IEC rated impulse withstand voltage Uimp	6.5kV
IEC power frequency withstand voltage	3.6kV
SUPPLY CIRCUIT CONNECTIONS	
Type of terminals	Fixed
Conductor section (min...max)	0.2...4mm ² (24...12AWG)
Maximum tightening torque	0.8Nm (7lb.in)
TARIFF INPUT CIRCUIT CONNECTIONS	
Type of terminals	Fixed
Conductor section (min...max)	0.2...4mm ² (24...12AWG)
Maximum tightening torque	0.8Nm (7lb.in)
RS485 CONNECTION	
Type of terminals	Fixed
Conductor section (min...max)	0.2...4mm ² (24...12AWG)
Maximum tightening torque	0.8Nm (7lb.in)
ENERGY METER INPUT CONNECTIONS	
Type of terminals	Fixed
Conductor section (min...max)	0.2...2.5mm ² (24...12AWG)
Maximum tightening torque	0.44Nm (4lb.in)
AMBIENT CONDITIONS	
Operating temperature	-20...+60°C
Storage temperature	-30...+80°C
Relative humidity	<90%
Maximum pollution degree	2
HOUSING	
Material	Polyamide

25 Metering instruments and current transformers

Technical characteristics
LCD multimeters and power analyzers



INDEX

TYPE	DMG100 - DMG110 ^①	DMG200	DMG210	DMG300
AUXILIARY SUPPLY				
Rated voltage U_s	100...240VAC/ 110...250VDC			
Voltage range	85...264VAC/ 93.5...300VDC			
Frequency range	45...66Hz, 360...440Hz			
Maximum power consumption	3.5VA	3.5VA	4.5VA	3.2VA
Maximum power dissipation	1.2W	1.2W	1.7W	1.3W
Microbreaking immunity	≥ 50 ms	≥ 50 ms	≥ 50 ms	≥ 50 ms
VOLTAGE INPUTS				
Type of input	Three-phase + neutral			
Maximum rated voltage U_e	690VAC phase-phase (400VAC phase-neutral)			
Measurement range	20...830VAC phase-phase (10...480VAC phase-neutral)			
Frequency range	45...66Hz, 360...440Hz			
Method of measurement	True RMS			
Method of connection	Single, two, three-phase with or without neutral, balanced three-phase systems			
CURRENT INPUTS				
Rated current I_e	5A	5A	5A	1A/5A
Current reading through Rogowski coils	-			
Measurement range	0.01...6A	0.01...6A	0.01...6A	0.01...1.2A / 0.01...6A
Method of measurement	True RMS			
Overload capacity	+20% I_e through external CT with 5A secondary			
Overload peak	50A for 1s			
INSULATION				
IEC rated insulation voltage U_i	690VAC			
IEC rated impulse withstand voltage U_{imp}	9.5kV			
IEC power frequency withstand voltage	5.2kV			
SUPPLY CIRCUIT/VOLTAGE MEASUREMENT CONNECTIONS				
Type of terminal	Fixed			
Conductor section (min...max)	0.2...4.0mm ² (24...12 AWG)			
Maximum tightening torque	0.8Nm (7lb.in)			
CURRENT MEASUREMENT CIRCUIT AND RS485^①				
Type of terminal	Fixed			
Conductor section (min...max)	0.2...2.5mm ² (24...12AWG)			
Maximum tightening torque	0.44Nm (4lb.in)			
AMBIENT CONDITIONS				
Operating temperature	-20...+60°C			
Storage temperature	-30...+80°C			
Relative humidity	<90%			
Maximum pollution degree	2			
Measurement class	III			
HOUSING				
Material	Polyamide			

① RS485 communication port for DMG110, DMG210, DMG610 and DMG611 only.

② Consult Technical support about versions with supply 12...48VDC; see contact details on inside front cover.

	DMG6...	DMG7000	DMG7500	DMG8000	DMG9000
	100...440VAC 120...250VDC		100...240VAC 120...250VDC		
	90...484VAC 93.5...300VDC		90...264VAC 93.5...300VDC		
	45...66Hz, 360...440Hz		45...66Hz, 360...440Hz		
	9.5VA		15VA		
	3.5W		6W		
	≥50ms		≥50ms		
	Three-phase + neutral		Three-phase + neutral		
	600VAC phase-phase (300VAC phase-neutral)		600VAC phase-phase (300VAC phase-neutral)		
	50...720VAC phase-phase (30...360VAC phase-neutral)		50...720VAC phase-phase (30...360VAC phase-neutral)		
	45...66Hz, 360...440Hz		45...66Hz, 360...440Hz		
	True RMS		True RMS		
	Single, two, three-phase with or without neutral, balanced three-phase systems				
	1A/5A		1A/5A		
	20...6300A (for DMG611...)		-		
	0.01...1.2A / 0.01...6A		0.005...1.2A / 0.005...6A		
	True RMS		True RMS		
	+20% Ie by external CT with 5A secondary 50A for 1s				
	600VAC		600VAC		
	9.5kV		9.5kV		
	5.2kV		5.2kV		
			Removable		
			0.2...2.5mm ² (24...12AWG)		
			0.5Nm (4.5lb.in)		
	Fixed		Removable		
	0.2...1.5mm ² (24...12AWG)		0.2...2.5mm ² (24...12AWG)		
	0.8Nm (7lb.in)		0.5Nm (4.5lb.in)		
			-20...+60°C		
			-30...+80°C		
			<90%		
			2		
			III		
			Polyamide		

TYPE		DMK10R1 DMK70R1	DMK11R1 DMK71R1	DMK15R1 DMK75R1	DMK16R1
AUXILIARY SUPPLY					
Rated voltage Us		220...240VAC			
Operating voltage range		0.85...1.1 Us			
Rated frequency		50...60Hz ±10%			
Maximum power consumption		3.6VA	3.6VA	3.6VA	3.9VA
Maximum power dissipation		1.8W	1.8W	1.8W	2.1W
VOLTAGE INPUTS					
Rated voltage Ue	phase-phase	600VAC	—	600VAC	600VAC
	phase-neutral	347VAC	—	347VAC	347VAC
Operating voltage range	phase-phase	15...660VAC	—	35...660VAC	35...660VAC
	phase-neutral	10...382VAC	—	20...382VAC	20...382VAC
Rated frequency		50...60Hz ±10%	—	50...60Hz ±10%	50...60Hz ±10%
Method of measuring		True RMS	—	True RMS	True RMS
CURRENT INPUTS					
Rated current Ie		—	5A	5A	5A
Measuring range		—	0.05...6A	0.05...5.75A	0.05...5.75A
Rated frequency		—	50...60Hz ±10%	50...60Hz ±10%	50...60Hz ±10%
Type of input		—	Shunts connected by external low voltage CT 5A max		
Type of measuring		—	True RMS	True RMS	True RMS
Overload capacity		—	+20% Ie	+20% Ie	+20% Ie
MEASURING ACCURACY					
Measurement conditions (Temperature +23°C ±1°C) (Relative humidity 45 ±15% R.H.)	voltage	±0.25% f.s. ±1 digit	—	±0.25% f.s. ±1 digit	±0.25% f.s. ±1 digit
	current	—	±0.5% f.s. ±1 digit	±0.5% f.s. ±1 digit	±0.5% f.s. ±1 digit
	power	—	—	1% f.s. ±1 digit	1% f.s. ±1 digit
	energy	—	—	—	Class 2
	frequency	—	—	—	±1 digit
RELAY OUTPUT					
Number and type of contact		1 changeover	1 changeover	1 changeover ^①	1 changeover
Rated voltage		250VAC	250VAC	250VAC	250VAC
IEC/EN/BS 60947-5-1 designation		AC1 8A 250VAC / B300	AC1 8A 250VAC / B300	AC1 8A 250VAC / B300	AC1 8A 250VAC / B300
Electrical life (ops.)		10 ⁵	10 ⁵	10 ⁵	10 ⁵
Mechanical life (ops.)		30x10 ⁶	30x10 ⁶	30x10 ⁶	30x10 ⁶
INSULATION					
Rated insulation voltage Ui		600VAC	415VAC	600VAC	600VAC
CONNECTIONS					
Type of terminals		Removable (DMK1...); fixed (DMK7...)			
Maximum tightening torque		0.5Nm (4.5lb.in) for DMK1...; 0.8Nm (7lb.in) for DMK7...			
Conductor section (min...max)		0.2...2.5mm ² (24...12AWG) for DMK0... 0.2...4.0mm ² (24...12AWG) for DMK7...			
AMBIENT CONDITIONS					
Operating temperature		-20...+60°C	-20...+60°C	-20...+60°C	-20...+60°C
Storage temperature		-30...+80°C	-30...+80°C	-30...+80°C	-30...+80°C
HOUSING					
Material		Thermoplastic (DMK1...)/ Polyamide (DMK7...)			

① One contact NO for DMK75R1.

TYPE		DMK00R1 DMK80R1	DMK01R1 DMK81R1	DMK02
AUXILIARY SUPPLY				
Rated voltage Us			220...240VAC	
Operating voltage range			0.85...1.1 Us	
Rated frequency			50...60Hz ±10%	
Maximum power consumption			3.6VA	
Maximum power dissipation			1.8W	
VOLTAGE INPUTS				
Rated voltage Ue		600VAC	—	600VAC
Operating voltage range		15...660VAC	—	15...660VAC
Operating voltage range, phase-phase		—	—	—
Rated frequency		50...60Hz ±10%	—	50...60Hz ±10%
Method of measuring		True RMS	—	True RMS
CURRENT INPUTS				
Rated current Ie		—	5A	5A
Measuring range		—	0.05...5.75A	0.05...5.75A
Rated frequency		—	50...60Hz ±10%	50...60Hz ±10%
Type of input		—	Shunts connected by external low voltage CT 5A max	
Type of measuring		—	True RMS	True RMS
Overload capacity		—	+20% Ie	+20% Ie
MEASURING ACCURACY				
Measurement conditions (Temperature +23°C ±1°C) (Relative humidity 45 ±15% R.H.)	cosφ	—	—	—
	voltage	±0.25% f.s. ±1 digit	—	±0.25% f.s. ±1 digit
	current	—	±0.5% f.s. ±1 digit	±0.5% f.s. ±1 digit
	frequency	—	—	—
ADDITIONAL ERRORS				
Relative humidity			±1 digit 60%...90% R.H.	
Temperature			±1 digit -20...+60°C	
RELAY OUTPUT FOR DMK... R1 TYPES ONLY				
Number and type of contact			1 changeover	
Rated voltage			250VAC	
IEC/EN/BS 60947-5-1 designation			AC1 8A 250VAC / B300	
Electrical life (ops.)			10 ⁵	
Mechanical life (ops.)			30x10 ⁶	
INSULATION				
Rated insulation voltage Ui		600VAC	415VAC	600VAC
CONNECTIONS				
Type of terminals			Fixed (DMK...); Removable (DMK0...)	
Maximum tightening torque			0.8Nm (7lb.in) for DMK0... / 0.5Nm (4.5lb.in) for DMK8...	
Conductor section (min...max)			0.2...2.5mm ² (24...12AWG) for DMK0... 0.2...4.0mm ² (24...12AWG) for DMK8...	
AMBIENT CONDITIONS				
Operating temperature			-20...+60°C	
Storage temperature			-30...+80°C	
HOUSING				
Material			Thermoplastic (DMK0...) / Polyamide (DMK8...)	



- Microprocessor supervision and control
- Accurate TRMS measurement circuit
- Automatic intelligent adjustment system
- Versions from 2 to 24 steps and up to 32 with Master-Slave function
- Versions with static outputs
- Versions for capacitive reactive power factor correction
- Use in cogeneration and medium-voltage systems
- Basic controller functionalities can be extended using the EXP series of expansion modules
- USB, serial, Ethernet communication interfaces
- Modbus-RTU and ASCII communication protocols
- Thyristor modules for dynamic correction.

	SEC. - PAGE
Reactive current control relay	
DCRM series	26 - 8
Automatic power factor controllers	
DCRL series	26 - 9
DCRG series	26 - 10
Accessories	26 - 12
Communication devices	26 - 12
Thyristor modules	26 - 13
Dimensions	26 - 14
Wiring diagrams	26 - 15
Technical characteristics	26 - 17

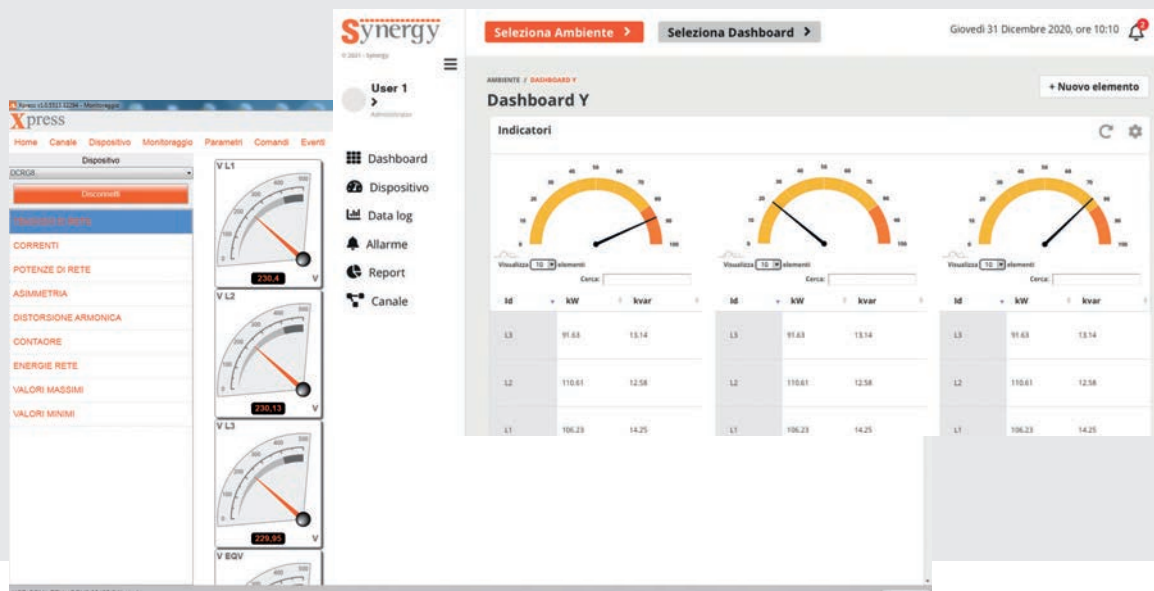



Page 26-8

DCRM SERIES

- Reactive current control relay
- Modular housing
- 2 steps
- Settings by front potentiometers
- 3 LED indications.



Page 26-9

DCRL SERIES (EXPANDABLE)

- Flush-mount housing: DCRL3 - DCRL5 (96x96mm/3.78x3.78") DCRL8 (144x144mm/5.67x5.67")
- 3/5/8 steps, expandable with EXP series modules (step increment, digital outputs, communication ports, etc.)
- Backlit icon LCD
- Ethernet communication interface (only for DCRL8)
- Alarm codes with scrolling texts, programmable in 6 languages (Italian, English, Spanish, French, German and Portuguese)
- Independent voltage measurement input
- Suitable for low and medium voltage systems
- Capacitor overload protection
- Internal panel temperature sensor
- Voltage and current harmonic-content measurement up to 15th order
- Front optical USB and Wi-Fi communication port for PC, smartphone and tablet connection
- Programmable alarms
- Protection via 2-level password to prevent all undesired access
- Compatible with **Synergy** and **Synergy^{Cloud}**, supervision and energy management software, **Xpress** configuration and remote control software and with the **Sami1** application for Android/iOS.



Page 26-10

DCRG SERIES (EXPANDABLE)

- Flush-mount housing: DCRG8 - DCRG8F - DCRG8IND (144x144mm/5.67x5.67")
- 8 steps, expandable with EXP series modules (step increment, inputs and outputs, communication ports, GPRS/GSM modem, data memory, etc.) and with Master-Slave function
- 128x80 backlit graphic LCD, facilitating data reading even in poor lighting conditions and the display of system information clearly and intuitively
- Ethernet communication interface
- Texts in 10 languages: Italian, English, Spanish, French, German, Czech, Polish, Russian, Portuguese and one customisable
- Voltage measurement input independent from the supply input
- Suitable for low and medium voltage systems
- Capacitor overload protection
- Internal panel temperature sensor
- Voltage and current harmonic-content measurement up to 31st order
- Dynamic power factor correction (DCRG8F version).
- Power factor correction by single phase (SPPFC)
- Capacitive reactive power factor correction (DCRG8IND version)
- Front optical USB and Wi-Fi communication port for PC, smartphone and tablet connection
- Programmable alarms
- Protection via 2-level password to prevent any undesired access
- Calendar-clock with backup reserve energy
- Logging of up to 250 events
- Compatible with **Synergy** and **Synergy^{Cloud}**, supervision and energy management software, **Xpress** configuration and remote control software and with the **Sami1** application for Android/iOS.



NFC

Page 26-13

THYRISTOR MODULES DCTL SERIES

- Version for steps from 7.5kvar to 120kvar
- Version with rated voltage from 400 to 690VAC
- Suitable for dynamic power factor correction
- Zero-crossing controlled connection-disconnection
- Over-temperature protection
- Monitoring and protection of current, power and current harmonics of the capacitor bank
- NFC connectivity for parameter settings and programming of protection thresholds with APP **NFC**
- Optical port for programming and diagnostic with software **Xpress** and APP **Sami1**
- Optional RS485 port for the command and monitoring by **DCRG8F** controller.



	DCRL3	DCRL5	DCRL8	DCRG8 / DCRG8IND	DCRG8F
Steps	3 relay steps (up to 6 with EXP1007)	5 relay steps (up to 8 with EXP1007)	8 relay steps (up to 14 with EXP1007)	8 relay steps (up to 18 relay outputs with EXP1006 and EXP1007) (up to 24 mixed relay and static outputs with EXP1001)	8 static steps (up to 24 static outputs with EXP1001) (up to 23 mixed relays and static outputs with EXP1006, EXP1007 and EXP1001)

ON FRONT/HOUSING

Display	Backlit icon LCD			128x80 pixel backlit graphic LCD	
Languages	6 (scrolling text of alarm codes only) Italian, English, Spanish, French, German, Portuguese			10 Italian, English, Spanish, French, German, Czech, Polish, Russian, Portuguese and 1 customisable	
Dimensions	96x96mm/ 3.78x3.78"	96x96mm/ 3.78x3.78"	144x144mm/ 5.67x5.67"	144x144mm/ 5.67x5.67"	
Protection rating	IP54	IP54	IP65	IP65	
Expandable with EXP... modules	●			●	

CONTROL/FUNCTIONS

Automatic recognition of current flow direction	●			●	
4-quadrant operation	●			●	
Master-Slave function				● (DCRG8 / DCRG8IND)	
Independent auxiliary supply input	●			●	
Three-phase voltage control				●	
Current inputs	1 (by 5A or 1A CTs)			3 (by 5A or 1A CTs)	
Dynamic (FAST) power factor correction				● with EXP1001 (maximum 16 static outputs) ●	
Power factor correction by single phase				●	
Possibility of connecting inductive steps				● (DCRG8IND)	
Possibility of use in medium voltage	●			●	
Possibility of phase-neutral insertion on a three-phase system	●			●	
Analog inputs				● with EXP1 04	
Analog outputs				● with EXP1005	
Input programmable as function or external temperature sensor				● with EXP1004	
USB communication interface	● with EXP1010			● with EXP1010	
RS232 communication interface	● with EXP1011			● with EXP1011	
Opto-isolated RS485 communication interface	● with EXP1012			● with EXP1012	
Ethernet communication interface	● with EXP1013 (only for DCRL8)			● with EXP1013	
Opto-isolated Profibus-DP interface				● with EXP1014	
GPRS/GSM modem				● with EXP1015	
Optical USB communication port on front	● with CX01			● with CX01	
Optical Wi-Fi communication port on front	● with CX02			● with CX02	
Fast setting of current transformer	●			●	
Compatible with Xpress configuration and remote control software	●			●	
Compatible with Synergy and Synergy ^{cloud} supervision and energy management software	●			●	
Compatible with Sam1 App	●			●	
Calendar-clock with backup reserve power				●	
Data logging memory				● with EXP1030	
Event logging: alarms, setup changes, etc.				●	
Customisable internal counters				●	



	DCRL3	DCRL5	DCRL8	DCRG8 / DCRG8IND	DCRG8F
MEASUREMENTS					
Rated measurement voltage		600VAC max		600VAC max	
Measurement voltage range		50...720VAC		50...720VAC	
Instantaneous $\cos\phi$		●		●	
Instantaneous and average weekly power factor values		●		●	
Voltage and current		●		●	
Reactive power to reach set-point and total values		●		●	
Capacitor overload		●		●	
Electrical panel temperature		●		●	
Maximum voltage and current value		●		●	
Maximum capacitor overload value		●		●	
Maximum panel temperature value		●		●	
Maximum capacitor temperature value				● with EXP1004 and EXP1015	
Active and apparent power value				●	
Active, reactive, apparent energy				●	
Current and voltage harmonic analysis		● up to 15th		● up to 31st	
Var-measured value for each step		●		●	
Number of switches for each step		●		●	
PROTECTIONS					
Voltage too high and too low		●		●	
Current too high and too low		●		●	
Over compensation (capacitors disconnected and $\cos\phi$ higher than set-point)		●		●	
Under compensation (capacitors connected and $\cos\phi$ lower than set-point)		●		●	
Capacitor overload		●		●	
Capacitor overload on all 3 phases				●	
Over temperature		●		●	
Mains micro-breaking		●		●	
Capacitor bank failure		●		●	
Exceeding switching limits		●		●	
Exceeding of maximum harmonic distortion level limit		●		●	
Programmable alarm property (enable, trip delay, relay energising, etc.)		●		●	
Capacitor protection				● with EXP1016	

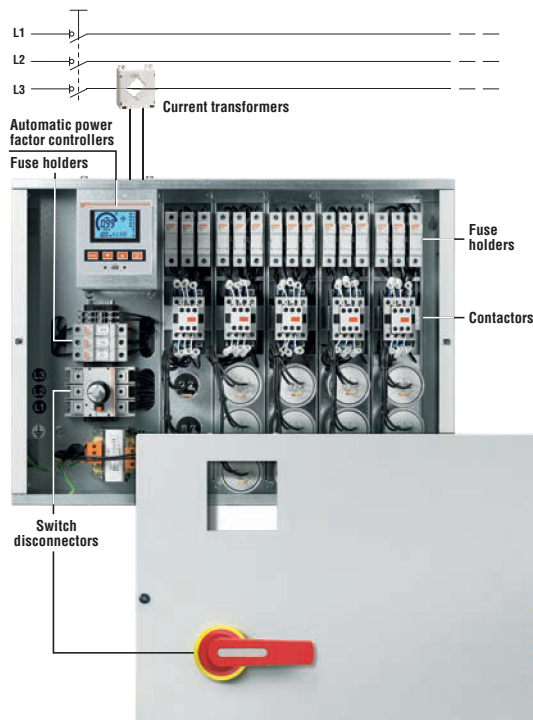

ESSENTIAL AND PERFORMANCE TOO! DCRL3 - DCRL5



● OPTICAL COMMUNICATION PORT

The optical port on the front permits communication with PCs, smartphones and tablets through the USB and Wi-Fi standards for carrying out programming, diagnostics and data download without disconnecting power to the electrical panel.



● USER INTERFACE

The backlit icon LCD ensures excellent legibility as well as the texts for the display of measurements and description of alarms. The 4 navigation buttons are for settings and functions.

● AN EXPANSION SLOT FOR EXP... SERIES MODULES

● EXPANDABLE UP TO 8 STEPS

● COMPACT SIZE

The space taken by the housing does not increase (96x96x73mm / 3.78x3.78x2.87") even with the expansion module fitted.

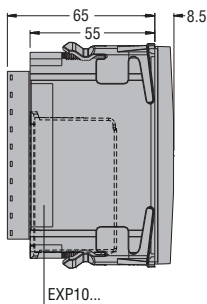

● FIXING SYSTEM

The fixing system with clips is simple, with a press to click into place and push to ensure retention over time. Correct application of the standard seal and clips in the panel ensures a front IP54 protection degree.



● EXPANDABILITY

Basic controller functionality can be extended easily using the EXP series expansion modules:

- digital outputs
- relay outputs to increase number of steps
- opto-isolated USB interface
- opto-isolated RS232 interface
- opto-isolated RS485 interface.



● SOFTWARE COMPATIBILITY

- **Sam1** Application for Android and iOS
- **Xpress** for configuration and remote control
- **Synergy** and **Synergy** for supervision and energy management.

● CHARACTERISTICS OF THE DCRL SERIES

– WIDE RANGE OF VOLTAGE MEASUREMENTS

The wide measurement range between 50...720VAC L-L and between 50...415VAC L-N allows the controllers to be used in most applications.

– SUITABLE FOR LOW- AND MEDIUM-VOLTAGE SYSTEMS

The controllers can be used in medium-voltage systems thanks to the ability to set a voltage transformer ratio, obtaining measurements regarding the transformer primary value both for adjustment and for the display.

– ALARM MESSAGES IN 6 LANGUAGES

The alarm texts can be displayed in Italian, English, French, German, Portuguese and Spanish.

– DEFECTIVE STEP

The DCRL measures the percentage of residual power for each step, comparing it with the value set in the main menu. The defective step alarm is generated if this value is below the set limit.

DCRL8

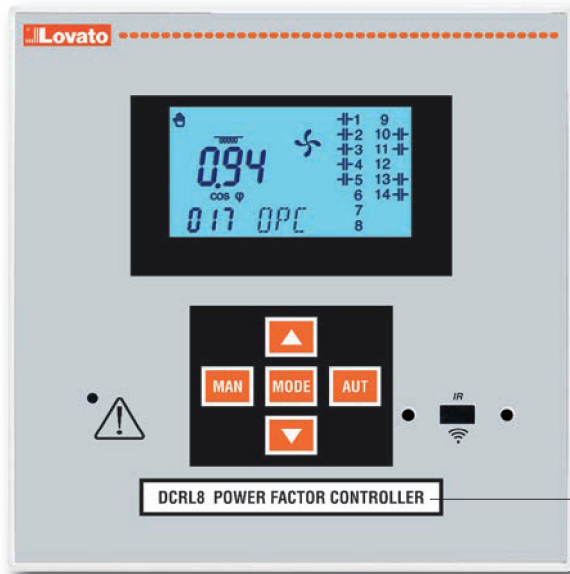

● USER INTERFACE

The backlit icon LCD ensures excellent legibility as well as the texts for the display of measurements and description of alarms. The 5 navigation buttons are for settings and functions, while an LED indicates the alarms and the optical port for communication via USB and Wi-Fi.

● EXPANDABLE UP TO 14 STEPS

● OPTICAL COMMUNICATION PORT

The optical port on the front permits communication with PCs, smartphones and tablets through the USB and Wi-Fi standards for carrying out programming, diagnostics and data download without disconnecting power to the electrical panel.

● TWO EXPANSION SLOTS FOR EXP... SERIES MODULES

● ETHERNET COMMUNICATION INTERFACE

By using the expansion module [EXP1013](#).

● CUSTOMISATION

An insert for labels customised with text, logos, codes, etc. is available, to be fixed onto the controller frames.

● COMPACT SIZE

Reduced profile and depth simplify installation of the power factor controller even in very compact electrical panels.

The total depth of the controller is 73mm (2.87") inside the panel with the expansion modules installed.

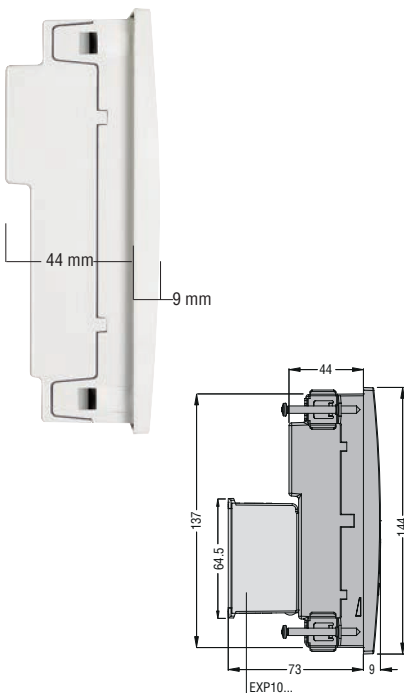

● FIXING SYSTEM

The fixing system **with metal screws** guarantees excellent, lasting retention over time.



● HIGH PROTECTION RATING

The front of the controller and seal have been designed to ensure a front protection rating of **IP65**.

● EXPANDABILITY

Basic controller functionality can be extended easily using the EXP series expansion modules:

- relay outputs to increase number of steps
- digital outputs
- opto-isolated RS232 interface
- opto-isolated RS485 interface
- opto-isolated ETHERNET interface.

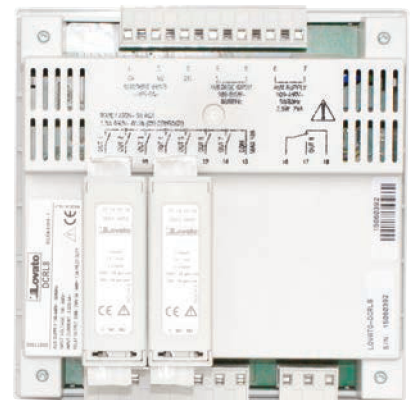

MAX 2

● SOFTWARE COMPATIBILITY

- **Sami** Application for Android and iOS
- **Xpress** for configuration and remote control
- **Synergy** and **Synergy** for supervision and energy management.

● CHARACTERISTICS OF THE DCRL SERIES

- 5A OR 1A IN THE SAME CONTROLLER

A parameter setting can easily allow to use 5A or 1A secondary current transformers.

- WHITE BACKLIT DISPLAY

It can be programmed to flash during alarm conditions.

- HARMONIC ANALYSIS

It includes voltage and current THD measurements and single harmonic measurement up to the 15th order and they can be shown on the display.

- MAINTENANCE INTERVALS

There are 2 counters: one to count the operating hours of the steps and the other for the number of interventions of each step. An alarm threshold can be set for both counters.

- BUILT-IN TEMPERATURE SENSOR

The internal temperature of the controller is monitored constantly by the built-in sensor.

The user can program the thresholds to activate and stop the cooling fan and/or generate the temperature alarm.

THE SOLUTION FOR ALL APPLICATIONS!

DCRG8

- **BACKLIT GRAPHIC LCD**
High-legibility 128x80 pixels, with adjustable brightness.

- **3 VERSIONS AVAILABLE:**
 - DCRG8: for traditional power factor correction with contactors or dynamic (fast) power factor correction with EXP1001
 - DCRG8F: for dynamic (fast) power factor correction
 - DCRG8IND: for capacitive reactive power factor correction.



- **OPTICAL COMMUNICATION PORT**
The optical port on the front permits communication with PCs, smartphones and tablets through the USB and Wi-Fi standards for carrying out programming, diagnostics and data download without disconnecting power to the electrical panel.

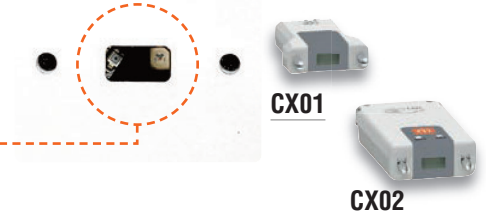

- **CUSTOMISATION**
There is a customisation slot available on the front panel for the description of the controller by adding texts, logos, codes, etc.

● **COMPACT SIZE**

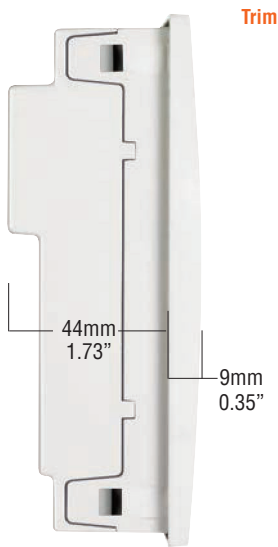

Frame profile and reduced total depth simplify installation of the controller also in very compact electric panels.

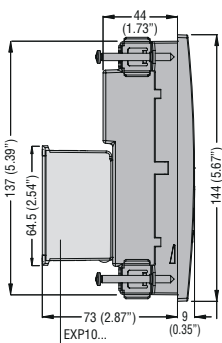

● **FIXING SYSTEM**



The fixing system with **metal screws** guarantees excellent retention over time.

- **HIGH PROTECTION DEGREE**
The controller front and the rear seal have been designed to warrant an **IP54** protection degree.

● **EXPANDABILITY**



Basic controller functionality can be extended easily using the EXP series expansion modules:

- Relay outputs to increase the number of steps
- Opto-isolated static outputs (also for dynamic correction)
- Capacitor protection
- Digital and analog inputs and outputs
- Expandable up to 24 mixed outputs
- Opto-isolated RS232 interface
- Opto-isolated RS485 interface
- Opto-isolated ETHERNET interface
- Opto-isolated Profibus-DP interface
- GPRS/GSM modem
- Data memory, calendar-clock with backup reserve power for data logging.

● **SOFTWARE COMPATIBILITY**

- **Sam1** Application for Android and iOS
- **Xpress** for configuration and remote control
- **Synergy** and **Synergy.com** for supervision and energy management.

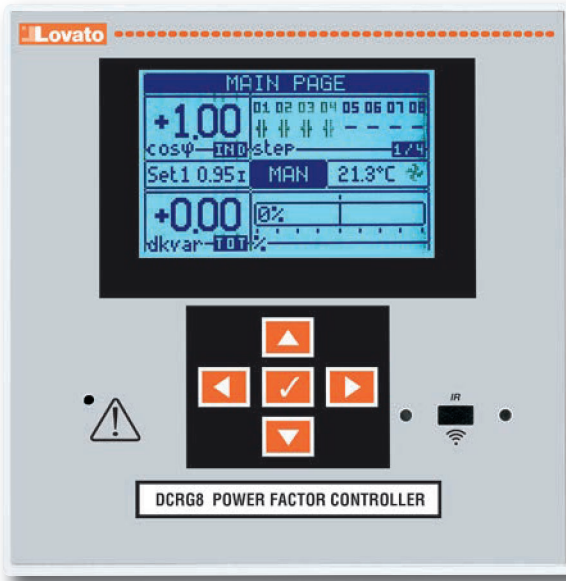

- SUITABLE FOR POWER FACTOR CORRECTION USING CONTACTORS AND THYRISTOR MODULES (WITH DCRG8F MODEL OR DCRG8 + EXP1001)
- INDEPENDENT POWER FACTOR CORRECTION FOR EACH SINGLE PHASE
- CAPACITIVE REACTIVE POWER FACTOR CORRECTION VIA INDUCTIVE STEP MANAGEMENT (WITH DCRG8IND MODEL)
- SMS SENDING FOR ALARM TRIGGERING
- DATA SENDING BY EMAIL OR FTP SERVER
- STREAMLINE DESIGN
The DCRG controller has an ergonomic design and, at the same time, particular care has been given to details.

● MASTER-SLAVE FUNCTION

The DCRG controller can control the outputs of other compatible controllers in addition to its own steps. In this way, it offers a **Master-Slave** architecture. Up to 8 slaves can be controlled to create a system with a maximum of 32 steps.

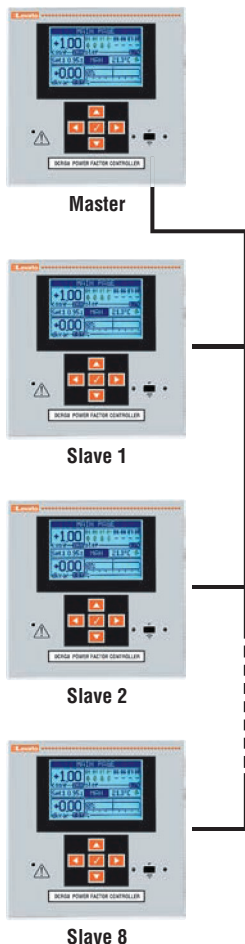

● CAPACITOR PROTECTION

By adding the dedicated EXP1016 expansion module, the DCRG controller can be equipped with additional capacitor protection functions. The module can measure the harmonic current values and the capacitor temperature on-site as well as detecting malfunction on any phase.

● 3 CURRENT INPUTS

- Independent power factor correction for each single phase
- Analysis of all electrical measurements in the system (multimeter).

● WIDE RANGE OF RATED VOLTAGE MEASUREMENTS

The wide measurement range between 100...600VAC allows the controller to be used in most applications.

● GSM/GPRS MODEM

With the EXP1015 expansion module, the controller is equipped with a GSM/GPRS modem, which is automatically configured. This simplifies installation and wiring. Once a data-enabled SIM card is inserted, the controller can send alarm or event SMS and e-mails and data files can be transmitted to FTP servers.

● 5A AND 1A BOTH IN THE SAME CONTROLLER

By configuring a specific parameter, the controller can be enabled for use with either a 5A or 1A secondary current transformer.

● GRAPHS AND TEXTS IN 10 LANGUAGES



Display of waveforms, graphs and texts in 10 languages: Italian, English, Spanish, French, German, Czech, Polish, Russian, Portuguese and one customisable.

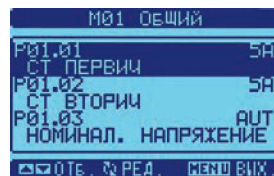

● SUITABLE FOR MEDIUM-VOLTAGE SYSTEMS

The controller can be used in medium-voltage systems thanks to the ability to set a voltage transformer ratio, obtaining measurements regarding the transformer primary value both for adjustment and for the display.

● DYNAMIC (FAST) POWER FACTOR CORRECTION

Thyristor-based dynamic power factor correction systems are necessary where the reactive load varies rapidly over time. DCRG8F has 8 built-in static outputs, while DCRG8 + EXP1001, by taking advantage of the built-in relay outputs as well, realizes a mixed traditional (relay) and dynamic system.

● INDEPENDENT POWER FACTOR CORRECTION FOR EACH SINGLE PHASE (SPPFC)

In highly unbalanced three-phase systems, power factor correction by single phase can be implemented. The DCRG controller can monitor the $\cos\phi$ of each single phase and correct through the joint use of single- and three-phase capacitor banks.

● CAPACITIVE REACTIVE POWER FACTOR CORRECTION (DCRG 8IND).

The DCRG8IND version can connect both capacitors and inductors to achieve the desired $\cos\phi$ should it be necessary to correct the capacitive reactive power factor as well.

DCRM series



DCRM2

Order code	Steps	Auxiliary supply voltage	Qty per pkg	Wt
	no.	[V]	n°	[kg]
Single and three-phase low-voltage systems.				
DCRM2	2	380...415VAC	1	0.284

General characteristics

The DCRM allows the reactive current of a system to be controlled.

It allows to reach the best $\cos\phi$ value possible, reducing the request for reactive current from the mains.

It can control the connection of two capacitor banks. Each one can be individually enabled and its power can be set through a dedicated trimmer.

It is also possible to adjust the time for connection and disconnection of the capacitors, thereby modifying the reaction speed of the system.

The controller can be used both in single-phase and three-phase wiring.

Operational characteristics

- Auxiliary supply voltage:
 - 380...415VAC standard
 - 220...240VAC and 440...480VAC on request
- Rated frequency: 50/60Hz
- 80...528VAC voltage measurement input
- Current measurement input:
 - By CT /5A
 - Measuring range: 0.1...6A
 - Measurement type: true root mean square (TRMS)
 - Automatic identification of CT connection polarity (straight / inverted)
- Relay outputs:
 - 2 relays (steps), each with 1 changeover contact
 - Rated current: 8A 250VAC (AC1)
 - Individual enablement of control of the two relays
- Modular DIN 43880 housing (3 modules)
- IEC degree of protection: IP40 on front (if placed in IP40 housing and/or electrical panel), IP20 terminals.

ADJUSTMENTS

"C/K Step 1"	C/K ratio step 1 (0.15...2)
"C/K Step 2"	C/K ratio step 2 (0.15...2)
"Connection delay"	Step connection delay 1...60s
"Disconnection delay"	Step disconnection delay 0.1...60s
"System configuration"	Single- or three-phase wiring selection.

INDICATIONS

- 1 green LED for power on and inhibition time
- 2 red LEDs for relay connection.

Certifications and compliance

Certifications obtained: UL Listed, for USA and Canada (File E93601), as Auxiliary Devices-Modular ampere monitoring relays (with 415VAC maximum only); EAC.

Compliant with standards: IEC/EN/BS 60255-5, IEC/EN/BS 61010-1, IEC/EN/BS 61000-6-2, IEC/EN/BS 61000-6-3, UL508, CSA C22.2 n°14.

DCRL series



DCRL3 - DCRL5



DCRL8



EXP8000



EXP10...

Snap-in fixing of EXP... expansion modules

DCRL3 - DCRL5 with 1 module



MAX 1

DCRL8 with 2 modules

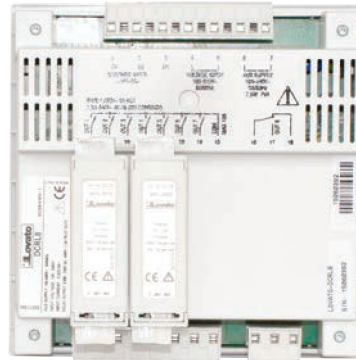

MAX 2

Backlit icon LCD

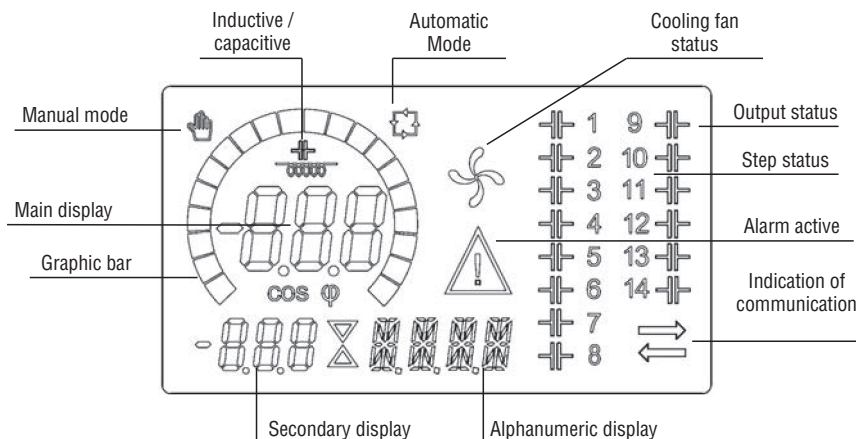

Order code	Description	Qty per pkg	Wt
		n°	[kg]
Single and three-phase low and medium-voltage systems.			
DCRL3	3 steps, expandable up to 6 steps, 100...440VAC	1	0.340
DCRL5	5 steps, expandable up to 8 steps, 100...440VAC	1	0.340
DCRL8	8 steps, expandable up to 14 steps, 100...440VAC	1	0.640
Accessory.			
EXP8000	Plastic insert for customisation label (only for DCRL3 and DCRL5)	10	0.050

Order code	Description
EXPANSION MODULES.	
Additional steps.	
EXP1006	2 relay outputs to increase number of power factor correction steps
EXP1007	3 relay outputs to increase number of power factor correction steps
Inputs and outputs.	
EXP1003	2 relay outputs 5A 250VAC
Communication ports.	
EXP1010	Opto-isolated USB interface
EXP1011	Opto-isolated RS232 interface
EXP1012	Opto-isolated RS485 interface
EXP1013	Opto-isolated ETHERNET interface (only for DCRL8)

General characteristics

The DCRL series has been developed with advanced functionality and produced with a dedicated ultra-compact housing. It combines modern front design with practical mounting and expandability (EXP... modules).

Its main features are:

- Backlit icon LCD with excellent information display
- Alarm codes with scrolling texts, programmable in 6 languages (Italian, English, Spanish, French, German and Portuguese)
- Connection in single or three phase lines and co-generation systems with 4-quadrant operation
- Voltage measurement input independent from the supply and which can be used in medium-voltage lines with VTs
- Drastic reduction of the the number of switching operations
- Balanced use of steps with same power rating
- Measurement of reactive power installed for each step
- Capacitor over-current protection
- Panel over-temperature protection via internal sensor
- Accurate micro-breaking protection
- Vast choice of measurements available, including voltage and current THD with single harmonic analysis up to the 15th order
- Wide voltage measurement range
- High accuracy of true root mean square (TRMS) measurements
- Front optical USB (CX01 dongle) and Wi-Fi (CX02 dongle) communication port for PC, smartphone and tablet connection
- Compatible with Ethernet communication modules EXP1013 (only for DCRL8)
- Compatible with Synergy and Synergy supervision and energy management software, Xpress configuration and remote control software and with the Sam1 application for Android/iOS
- Customisation with label on front (only for DCRL8).

Operational characteristics

- Supply:
 - Auxiliary voltage: 100...440VAC
 - Frequency: 50/60Hz ±10%
- Voltage input:
 - Rated voltage: 600VAC L-L (346VAC L-N)
 - Frequency range: 45...65Hz
- Current input:
 - Single-phase connection
 - Rated current: 1A or 5A, configurable
- Measurements and control:
 - Power factor adjustment: 0.5ind...0.5cap.
 - Voltage measurement range: 50...720VAC L-L; 50...415VAC L-N
 - Current measurement range: 0.025...1.2A for 1A full scale; 0.025...6A for 5A full scale
 - Type of voltage and current measurement: true root mean square (TRMS)
- Relay outputs (steps):
 - DCRL3: 3 outputs
 - DCRL5: 5 outputs
 - DCRL8: 8 outputs
 - Contact arrangement: NO; the last is a changeover
 - Rated current: 5A 250VAC AC1
- Flush-mount housing:
 - DCRL3, DCRL 5 (96x96mm / 3.78x3.78");
 - DCRL8 (144x144mm / 5.67x5.67")
- IEC degree of protection:
 - DCRL3, DCRL5 IP54 and DCRL8 IP65 on front; IP20 on terminals for all.

Certifications and compliance:

Certifications obtained: UL Listing for USA and Canada (cULus - File E93601), as Auxiliary Devices - Power factor controllers, EAC, RCM. Compliant with standards: IEC/EN/BS 61010-1, IEC/EN/BS 61000-6-2, IEC/EN/BS 61010-2-030, IEC/EN/BS 61000-6-3 (only for DCRL8), IEC/EN/BS 61000-6-4 (only for DCRL3-5), UL 508, CSA C22.2 n°14.

Contactors for power factor correction

See section 2, page 2-16.

Software Synergy, Synergy, Xpress and Sam1 See section 30.

EXP expansion modules

See section 31.

DCRG series



DCRG8



EXP10...

Snap-in fixing of 4 EXP... expansion modules

DCRG8 / DCRG8F / DCRG8IND



Order code	Description	Qty per pkg	Wt [kg]
DCRG8	8 relay steps, expandable up to 24 steps, 100...415VAC	1	0.980
DCRG8F	8 static steps, expandable up to 24 steps, 100...415VAC	1	0.980
DCRG8IND	8 relay steps, expandable up to 24 steps, 100...415VAC, for capacitive reactive power factor correction	1	0.980
Accessories.			
NTC01	Remote temperature sensor, length 3m/3.3yd	1	0.150

Order code	Description
EXPANSION MODULES Additional steps.	
EXP1006	2 relay outputs to increase number of power factor correction steps
EXP1007	3 relay outputs to increase number of power factor correction steps
Inputs and outputs.	
EXP1000	4 opto-isolated digital inputs
EXP1001	4 opto-isolated static outputs to increase number of static steps
EXP1002	2 digital inputs and 2 opto-isolated static outputs
EXP1003	2 relay outputs 5A 250VAC
EXP1004	2 PT100 opto-isolated analogue inputs, either 0/4...20mA, 0...10V or 0...±5V
EXP1005	2 opto-isolated analogue inputs 0/4...20mA, 0...10V or 0...±5V
EXP1008	2 opto-isolated digital inputs and 2 relay outputs 5A 250VAC
EXP1016	Capacitor protection with 2 inputs for temperature measurement with NTC sensors and 2 three-phase measurement inputs

Communication ports.	
EXP1010	Opto-isolated USB interface
EXP1011	Opto-isolated RS232 interface
EXP1012	Opto-isolated RS485 interface
EXP1013	Opto-isolated ETHERNET interface
EXP1014	Opto-isolated Profibus-DP interface
EXP1015	GPRS/GSM modem, without antenna
Other functions.	
EXP1030	Data memory, calendar-clock with backup reserve power for data logging

❶ For configuration via software, contact our Technical support.

Maximum expandability DCRG8 / DCRG8IND / DCRG8F

Controller	Steps	EXP1006	EXP1007	EXP1001	TOTAL STEPS	
		Module with 2 relay outputs no. of modules	Module with 3 relay outputs no. of modules	Module with 4 static outputs no. of modules	Relay	Static
DCRG8 / DCRG8IND	8	4 (2 steps)	–	–	16	–
	8	2 (2 steps)	max 2 (3 steps)	–	18	–
	8	–	–	max 4 (4 steps)	8	16
DCRG8F	8	4 (2 steps)	–	–	8	8
	8	2 (2 steps)	max 2 (3 steps)	–	10	8
	8	–	–	max 4 (4 steps)	–	24

General characteristics

The DCRG automatic power factor controller meets the technical requirements of modern electrical systems in industry. It is designed to comply and has the option to extend its functionality by using specific EXP series expansion modules. Mention should also be made of the optical communication port as standard, for programming the controller, diagnostics and data download.

The backlit graphic LCD facilitates data reading even in poor lighting conditions and permits the display of system information clearly and intuitively.

Its main features are:

- 128x80-pixel backlit graphic LCD with texts in 10 languages: Italian, English, Spanish, French, German, Czech, Polish, Russian, Portuguese and one customisable
- Connection in single and three-phase lines as well as three-phase lines with neutral control and cogeneration systems (4 quadrants)
- Capacitive reactive power factor correction (DCRG8IND only)
- Independent power factor correction for each single phase (SPPFC only for DCRG8 / DCRG8IND)
- Suitable for dynamic power factor correction with DCRG8F or DCRG8 + EXP1001
- Control of thyristor modules type DCTL... with static outputs or RS485 connection with DCRG8F controller
- Use with medium-voltage lines with VTs (DCRG8 / DCRG8IND only)
- Capability for correct operation even in systems characterised by high harmonic content
- Drastic reduction in the number of switching operations
- Balanced use of steps with same power rating
- Measurement of reactive power installed for each step
- Recording of the number of connections for each step
- Capacitor over-current protection on all three phases
- Panel over-temperature protection via internal sensor and external sensor
- Accurate micro-breaking protection
- Current and voltage harmonic analysis
- Quick CT programming function
- USB (CX01 dongle) and Wi-Fi (CX02 dongle) communication port for PC, smartphone and tablet connection
- Modbus-RTU TCP and ASCII communication protocol
- Compatible with Synergy and Synergy supervision and energy management software, Xpress configuration and remote control software and with the Sam1 application for Android/iOS
- Sending and reception of SMS, sending of e-mails with alarm diagnosis and data files, FTP Client function (with EXP1015 module).

Operational characteristics

- Voltage measurement circuit:
 - Auxiliary supply voltage: 100...415VAC
 - Rated frequency: 50/60Hz (±10%)
- Current measurement circuit:
 - Single and three-phase input
 - Rated current: 5A (1A programmable)
- Measurements and control:
 - Power factor adjustment: 0.5ind...0.5cap.
 - Voltage measurement range: 50...720VAC
 - Current measurement range: 0.025...6A
 - Temperature measurement range: -30...+85°C
 - Capacitor overload current measurement range: 0...250%
 - Type of voltage and current measurement: true root mean square (TRMS)
- Relay outputs:
 - 7 each with NO contact and the last as changeover
 - Rated current: 5A 250VAC AC1
- Flush-mount housing (144x144mm / 5.67x5.67")
- IEC degree of protection: IP65 on front; IP20 on terminals.

Certifications and compliance

Certifications obtained: UL Listing for USA and Canada (cULus - File E93601), as Auxiliary Devices - Electronic power factor regulator, RCM, EAC. Compliant with standards: IEC/EN/BS 61010-1, IEC/EN/BS 61000-6-2, IEC/EN/BS 61000-6-4, UL508, CSA C22.2 n°14.

Contactors for power factor correction

See section 2, page 2-16.

Software Synergy, Synergy_{mod}, Xpress and Sam1

See section 30.

EXP expansion modules

See section 31.

“Master-Slave” power factor correction system with DCRG8

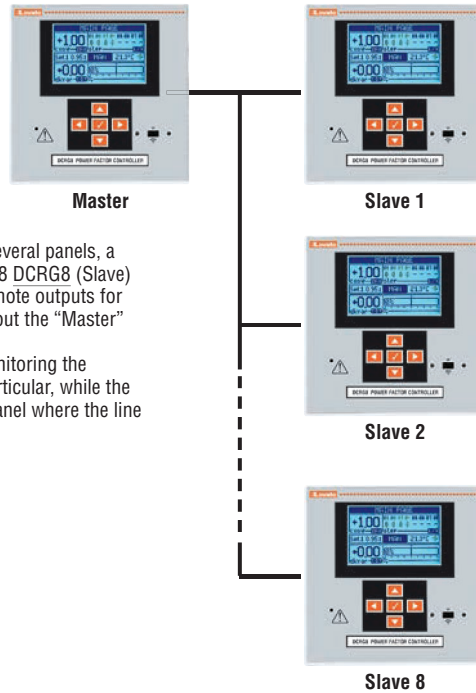

When the correction system is divided into several panels, a DCRG8 (Master) controller can control up to 8 DCRG8 (Slave) controllers. The “Slave” controllers act as remote outputs for the connection of capacitor banks that carry out the “Master” controller’s commands.

The single controllers are responsible for monitoring the electrical panel and the capacitor banks in particular, while the $\cos\phi$ reading is centralised in the “Master” panel where the line arrives.

Software and APP

Xpress configuration and remote control software



Synergy Supervision and energy management software



Sami APP

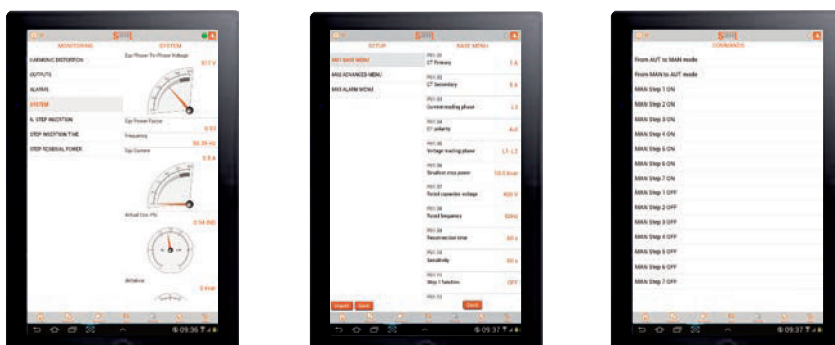

General characteristics

By using the Xpress software, the quick setup of the controllers can be carried out via PC, avoiding parameter programming errors.

The parameter programming of a DCR... or DCRG8... controller can also be saved on PC and quickly loaded into another device requiring the same programming.

It permits the following operations:

- System operation monitoring:
 - Graphical and numerical display of measurements
 - Controller status
- Capacitor efficiency control
 - Current kvar measurement for each step
 - Counters for the number of connections for each step
 - Total hour counter for connection time for each individual step
 - Access all setup parameters
 - Saving / loading parameters
 - Highlighting of changed values
 - Resetting to default values.

The Synergy software permits remote control and supervision of the DCR... and DCRG8... controllers. See section 30 for details.

This software has structures and applications based on MS SQL relational databases, and the data can be consulted using the most popular browsers.

It is a highly versatile system, simultaneously accessible to a large number of users/workstations via intranets, VPN or Internet.

APP for smartphone and tablet

The Sami application allows the user to program the controller, view alarms, send commands, read measurements, download statistical data and events and send retrieved data by e-mail. The connection is made by Wi-Fi with a smartphone or tablet using the CX02 device. It is iOS and Android compatible.

For details, consult section 30 or our Technical support; see contact details on inside front cover.



26 Automatic power factor controllers and thyristor modules

Accessories for DCRL and DCRG



EXCM4G01

new

Order code	Description	Qty per pkg	Wt
		n°	[kg]
51C2	Connection cable PC↔DCRL/DCRG+ EXP10 11 length 1.8m/2yd	1	0.090
EXCCON01	RS485/ Ethernet converter, 12...48VDC, including DIN rail fixing kit	1	0.400
EXCM4G01	RS485 gateway/4G modem, 9...36VDC, including cable for programming	1	0.340

❶ Consult our Technical support for modem details; see contact details on front cover.

Communication devices



CX01



CX02



CX03

Order code	Description	Qty per pkg	Wt
		n°	[kg]
CX01	USB/optical device PC↔DCRL/DCRG, for programming, data download, diagnostics and updating firmware	1	0.090
CX02	Wi-Fi connection device for PC↔DCRL/DCRG, for downloading data, programming, diagnostics and cloning	1	0.090
For DCRG8... type only.			
CX03	GSM penta-band antenna (850/900/1800/1900/2100MHz)	1	0.090

General characteristics

Communication and connection devices to connect the DCRL and DCRG power factor controllers to personal computers, smartphones and tablets.

CX01

This USB device, complete with cable, permits connection of the power factor controller with a PC without needing to disconnect the electrical panel supply, in order to:

- Program parameters
- Copy the settings to external units
- Download data and events
- Carry out diagnostics
- Update the firmware.

The PC identifies the connection as a standard USB.

CX02

Via Wi-Fi connection, the power factor controllers can be viewed from PCs, smartphones and tablets without having to connect cables, in order to:

- Program parameters
- Download data and events
- Carry out diagnosis and cloning of the device.

CX03

Compatible with major worldwide mobile phone networks, thanks to the use of 850/900/1800/1900/2100MHz frequencies.

IEC degree of protection: IP67.

Fixing hole Ø10mm (0.40").

Cable length 2.5m/2.73yd.

For dimensions, wiring diagrams and technical characteristics, consult the manuals available online in the Download section of the following website:

www.LovatoElectric.com.

DCTL series



DCTL...



NFC



Accessories for DCTL



EXC1042



EXP8003



NTC01



EXA01



EXA02

Power connections with double lug clamps



The thyristor modules type DCTL up to 60kvar are provided with power connections with double lug clamps which allows to simplify the wiring, in particular when is necessary to connect more thyristor modules in parallel.

Order code	Step power	Qty per pkg	Wt
	[kvar]	n°	[kg]
Versions with rated voltage 400VAC.			
DCTLA4000075	7.5kvar at 400VAC step module	1	1.74
DCTLA4000150	15kvar at 400VAC step module	1	1.74
DCTLA4000300	30kvar at 400VAC step module	1	1.74
DCTLA4000500	50kvar at 400VAC step module	1	2.84
DCTLA4001000	100kvar at 400VAC step module	1	6.68
Versions with rated voltage 400...480VAC.			
DCTLA4800090	9kvar at 480VAC step module	1	1.74
DCTLA4800180	18kvar at 480VAC step module	1	1.74
DCTLA4800360	36kvar at 480VAC step module	1	1.74
DCTLA4800600	60kvar at 480VAC step module	1	2.84
DCTLA4801200	120kvar at 480VAC step module	1	6.68
Versions with rated voltage 600...690VAC IEC, 600VAC cULus.			
DCTLA6900300	30kvar at 690VAC step module	1	2.84
DCTLA6900500	50kvar at 690VAC step module	1	2.84
DCTLA6901000	100kvar at 690VAC step module	1	6.68

Order code	Description	Qty per pkg	Wt
		n°	[kg]
EXC1042	RS485 communication board	1	0.020
EXP8003	DIN rail mount kit for DCTL up to 60kvar max	1	0.200
NTC01	Remote temperature sensor, 3m	1	0.150
CX01	USB connection dongle PC<->DCTL, for programming diagnostics and firmware update	1	0.090
CX02	Wi-Fi connection dongle PC<->DCTL, for programming, diagnostics and cloning	1	0.090
EXA01	Kit of 3 UL terminal lugs for DCTLA4001000, DCTLA4801200 and DCTLA6901000	1	0.141
EXA02	Kit of 3 terminal protection covers for DCTLA4001000, DCTLA4801200 and DCTLA6901000	1	0.125

Connection to the automatic power factor controller type DCRG8F via RS485

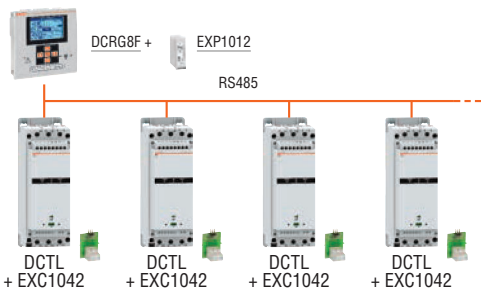

Alternatively to the standard command from static outputs, the thyristor modules type DCTL can be connected to the automatic power factor controller type DCRG8F with the RS485 optional port (code EXC1042), obtaining a simple and linear wiring.

In this configuration, it is possible to monitor from the display of the DCRG8F controller the status and measures of each DCTL module such as step power, currents, harmonics, temperature, working hours, etc.



General characteristics

- Suitable for dynamic (fast) power factor correction
- Silent operation
- Zero-crossing switching
- Monitoring and protection of the current, power and current harmonics of the capacitor bank: thanks to the presence of integrated current transformers, it is possible to monitor and protect the capacitor bank against overcurrents caused by events like the distortion of the voltage waveform. It is also possible to monitor electrical measurements of the capacitor bank such as the residual power three-phase voltages and currents, temperatures, THDI, morning hours, etc...
- Over-temperature protection via built-in sensor and input for the optional external temperature sensor NTC01 for the measure of the temperature in the area of installation of the capacitors
- Ready to work without need of any programming when used with standard features
- NFC connectivity for parameter settings and programming of the protection thresholds (overtemperature, overcurrent, overvoltage,...) with the App Lovato **NFC** freely downloadable from Google Play Store and App Store
- Optical port for programming and diagnostic with software **Xpress** and App **Sami**, connection with USB dongle (CX01) or Wi-Fi dongle (CX02)
- Command circuit made by 8...30VDC signal or dry contact (which allows to save the use of a power supply)
- Optional RS485 communication card (code EXC1042) for the command and monitoring from power factor controller type DCRG8F; from the display of DCRG8F is also possible to monitor the status and the measurements (temperature, power,...) of each DCTL
- 1 programmable relay output with changeover contact for the signalling of alarms or fan command
- Possibility to install the thyristor modules DCTL in both vertical and horizontal position without derating, thanks to the built-in fans
- Monitoring of the functioning of the fans with the analog measure of the current through integrated sensor, which allows to control the status of the fan and recognize automatically any fault like jamming or disconnection
- Power connections with double screw terminals (for sizes up to 60kvar), which simplify the wiring, in particular for the connection of more thyristor modules in parallel; it is also possible to decide to cable or not the central phase according to the layout of the power factor correction panel
- Panel fixing with screw or on DIN guide with the optional accessory EXP8003 (only for sizes up to 60kvar).

Operational characteristics

- Step power:
 - 7.5, 15, 30, 50 and 100kvar at 400VAC
 - 9, 18, 36, 60 and 120kvar at 480VAC
 - 30, 50 and 100kvar at 600...690VAC
- Rated operating voltage:
 - 400VAC (IEC and cULus) for version DCTLA400...
 - 400...480VAC (IEC and cULus) for version DCTLA480...
 - 600...690VAC (IEC), 600VAC (cULus) for version DCTLA690...
- Rated frequency 50/60Hz
- Auxiliary supply voltage: 100...240VAC ± 10%
- Command circuit: 8...30VDC or dry contact or RS485 connection from DCRG8F controller
- Controlled phases: 2
- Forced ventilation monitored from the control logic
- Operating temperature: -20...+45°C (up to 55°C with derating)

INDICATIONS

- LED POWER: presence of supply
- LED FAULT: alarm active (n° flashes = type of alarm)
- LED ON: command active.

Certifications and compliance:

Certifications obtained: cULus.
Compliant with standards: IEC/EN/BS 60947-4-3, IEC/EN/BS 61000-6-2, IEC/EN/BS 61000-6-4.

REACTIVE CURRENT CONTROL RELAY
DCRM2

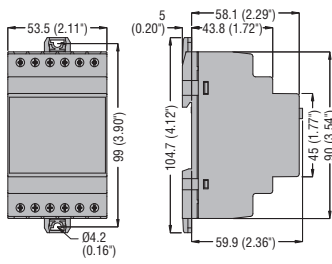

AUTOMATIC POWER FACT CONTROLLERS
DCRL3 - DCRL5

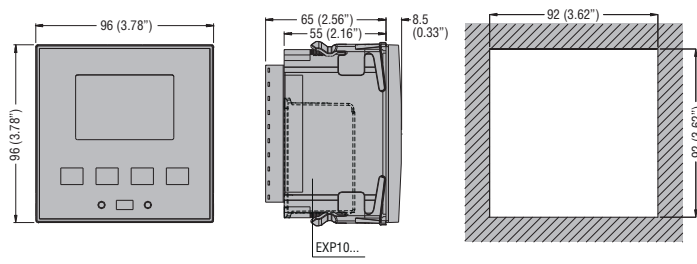

DCRL8 - DCRG8...

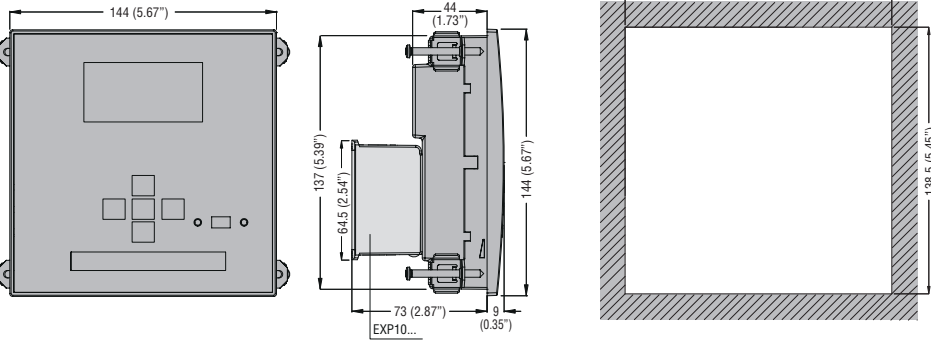

THYRISTOR MODULES

DCTLA4000075 - DCTLA4000150 - DCTLA4000300
DCTLA4800090 - DCTLA4800180 - DCTLA4800360

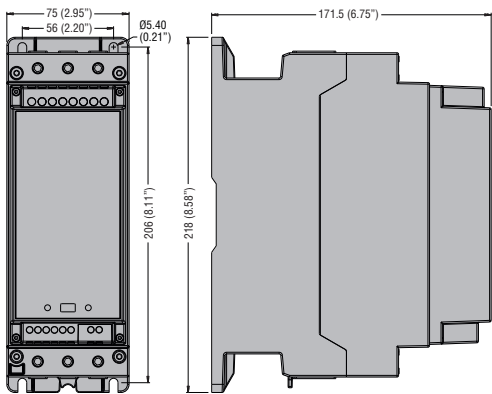

DCTLA4000500 - DCTLA4800600
DCTLA6900300 - DCTLA6900500

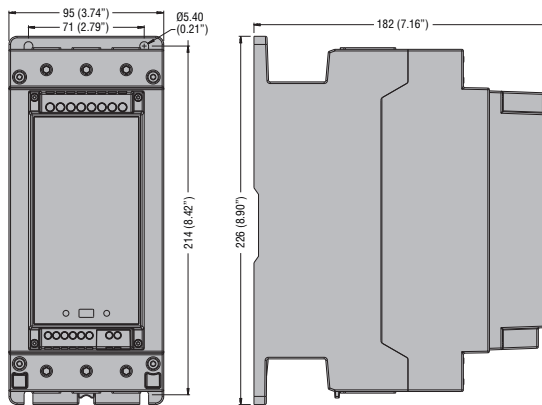

DCTLA4001000 - DCTLA4801200
DCTLA6901000

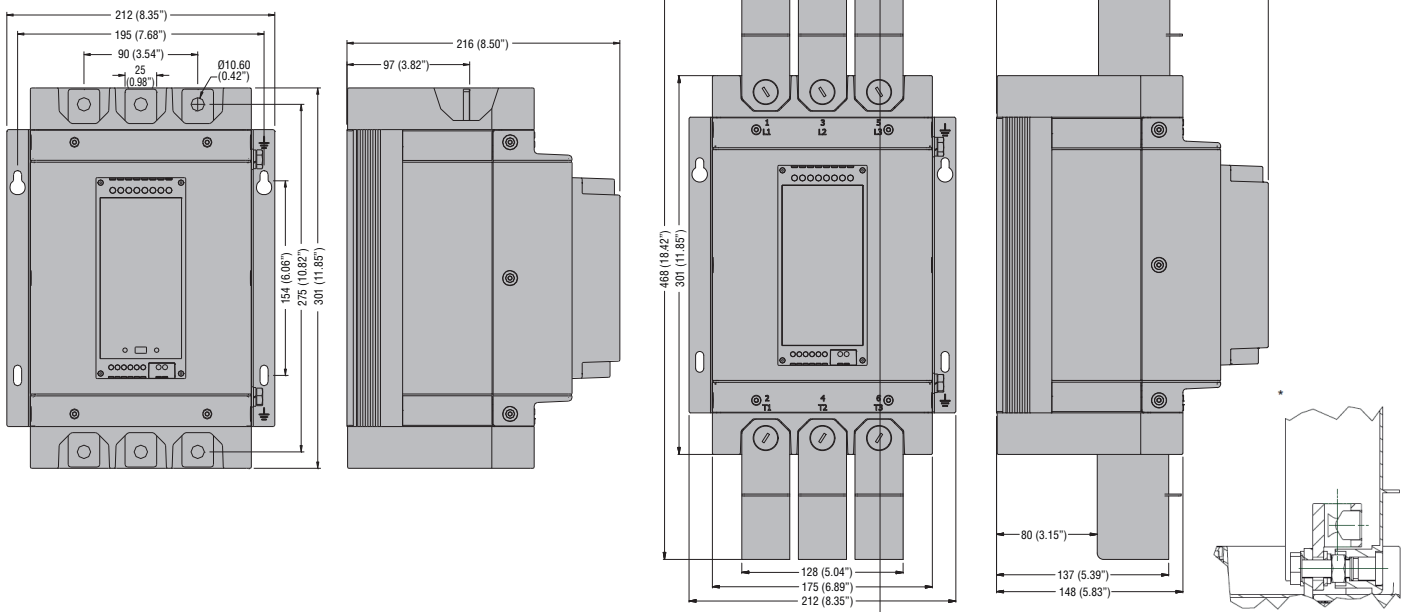

DCTLA4001000, DCTLA4801200, DCTLA6901000 complete with terminal lugs kit EXA01 and terminals protection kit EXA02 (necessary only for cULus compliance).

REACTIVE CURRENT CONTROL RELAY

DCRM2

Single-phase connection

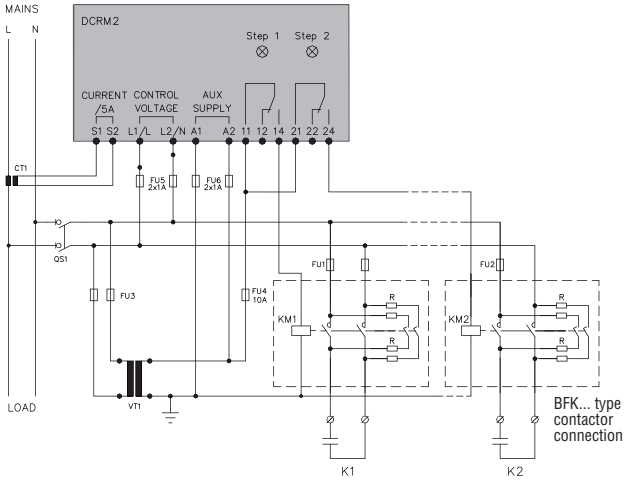

Three-phase connection

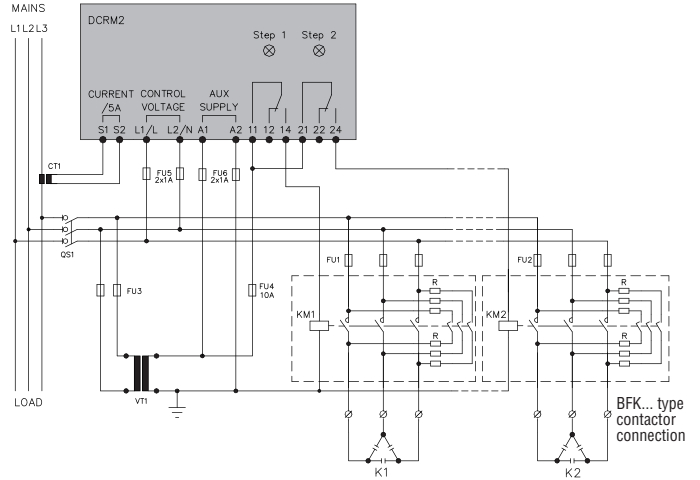

IMPORTANT

- a. For three-phase connection, the voltage measurement input must be connected between two phases; the line CT must be connected on the remaining phase.
- b. The polarity of the current measurement input is irrelevant.

CAUTION! Always disconnect the power supply when operating on the terminals.

AUTOMATIC POWER FACTOR CONTROLLERS

DCRL... with BFK... type contactors

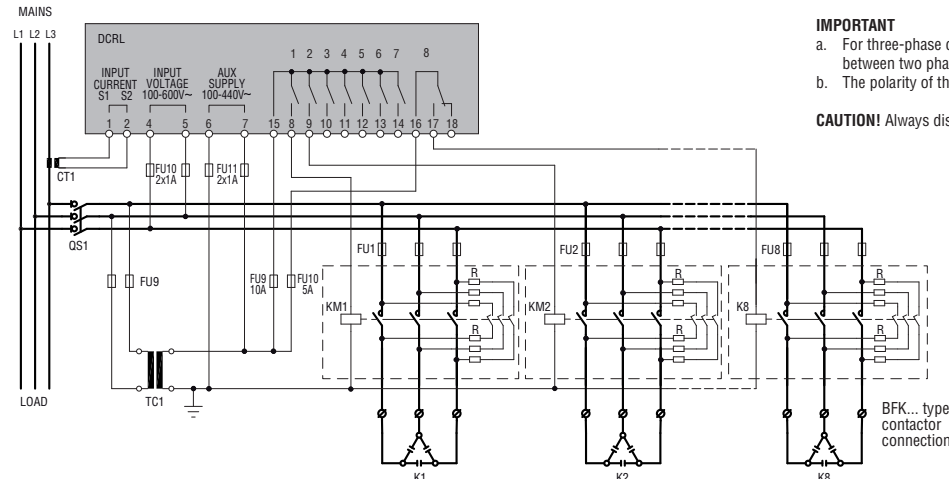

IMPORTANT

- a. For three-phase connection, the voltage measurement input must be connected between two phases; the line CT must be connected on the remaining phase.
- b. The polarity of the current measurement input is irrelevant.

CAUTION! Always disconnect the power supply when operating on the terminals.

AUTOMATIC POWER FACTOR CONTROLLERS

DCRG8 with BF...K type contactors

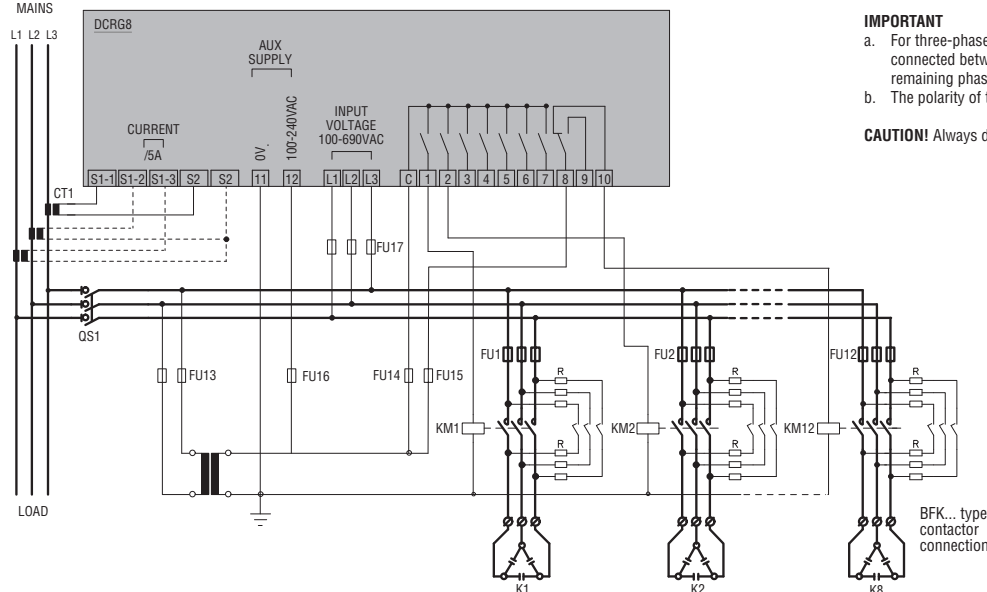

IMPORTANT

- a. For three-phase connection, the voltage measurement input must be connected between two phases; the line CT must be connected on the remaining phase.
- b. The polarity of the current measurement input is irrelevant.

CAUTION! Always disconnect the power supply when operating on the terminals.

DCRG8IND

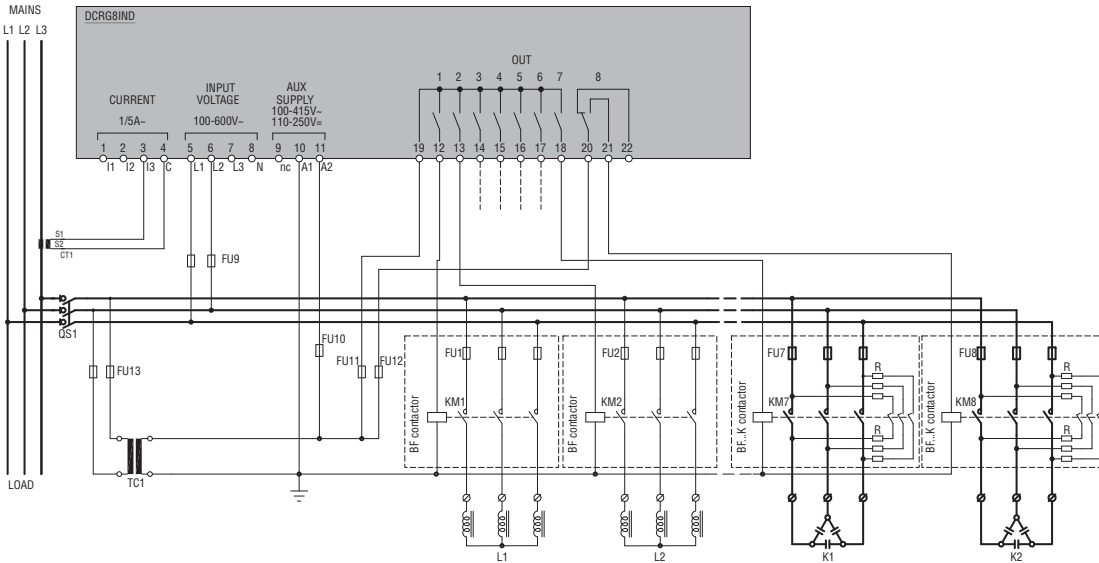

DCRG8F

Thyristor module control via 8 ... 30VDC signal

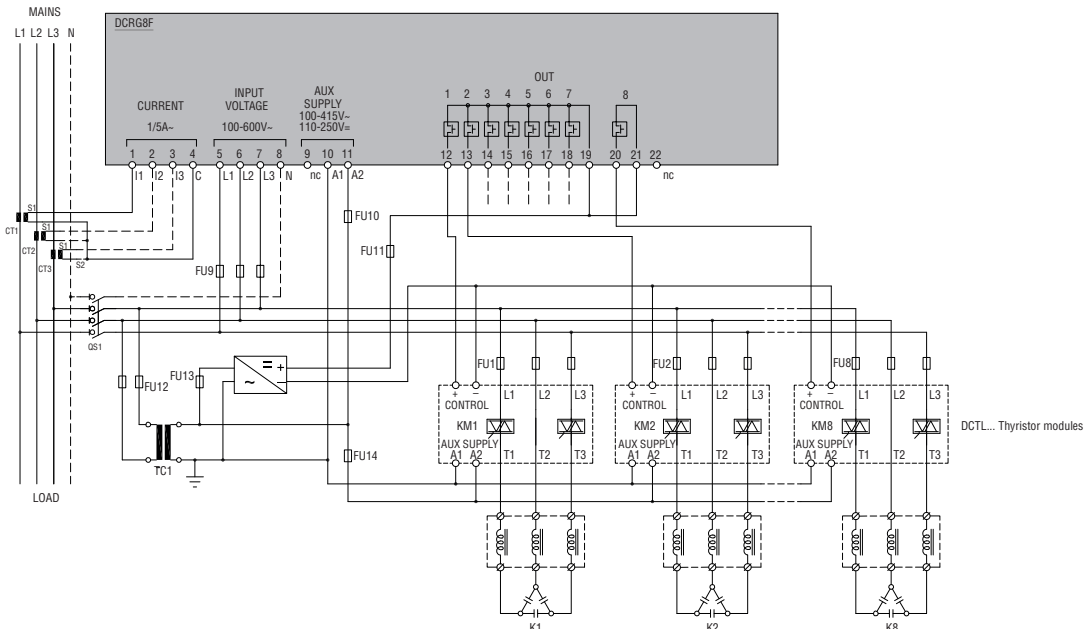

DCRG8F

Thyristor module control via clean contact (only with DCTL)

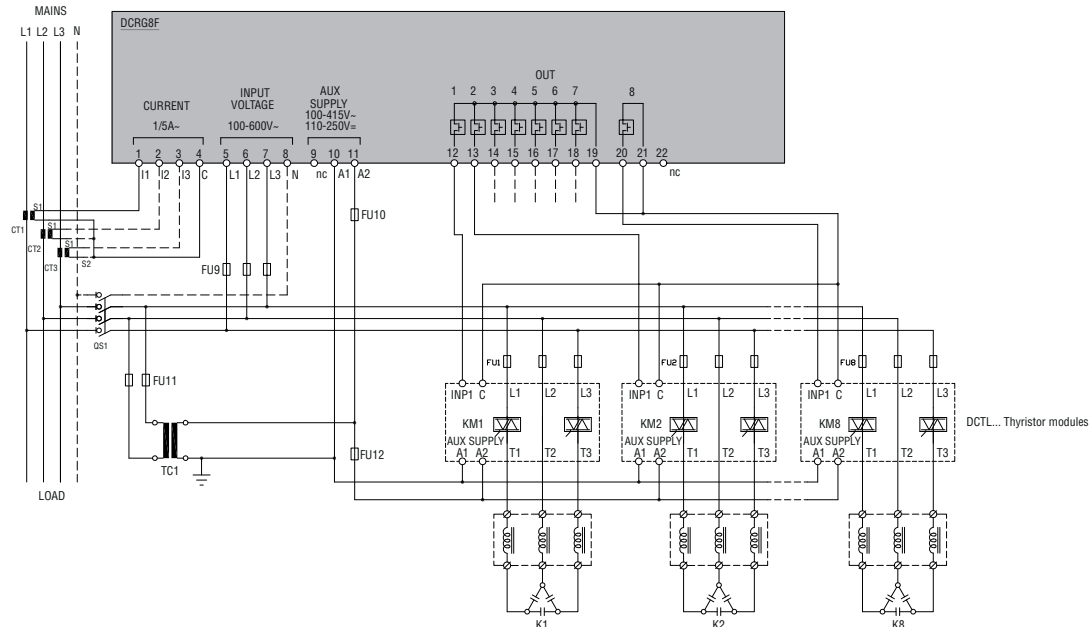

TYPE	DCRM2
AUXILIARY SUPPLY CIRCUIT	
Rated auxiliary voltage (Us)	380...415VAC standard 220...240VAC and 440...480VAC on request❶
Operating range	0.85...1.1Us
Rated frequency	50/60Hz ±5%
Maximum power consumption/dissipation	4.4VA / 2.4W
Micro-breaking immunity	≤17ms
No-voltage release	≥8ms
VOLTAGE INPUT	
Maximum rated voltage Ue	480VAC❶
Measuring range	80...528VAC
Frequency range	50 or 60Hz ±1% self configurable
Measurement input impedance	>1MΩ
Type of connection	L1-L2 or -N
CURRENT INPUT	
Type of connection	By current transformer (CT)
Rated current Ie	5A AC
Measurement range	0.1...6A
Type of input	Shunt supplied by external current transformer (low voltage). Max. 5A
Measurement method	True RMS value
Overload capacity	+20% Ie
Overload peak	10In for 1s
Dynamic limit	160A for 10ms
Burden	≤0.6W
ADJUSTMENTS	
C/K step 1 and 2	OFF / 0.15...2
Connection / disconnection	1...60s
System configuration	3-phase - 1-phase
RELAY OUTPUTS	
Number of relays	2 (each with 1 changeover)
Rated operational voltage	250VAC
Maximum switching voltage	400VAC
IEC conventional free air thermal current (Ith)	8A
IEC/EN/BS 60947-5-1 and UL/CSA designation	B300
Electrical life with rated load	10 ⁵ cycles
Mechanical life	30x10 ⁶ cycles
INSULATION (input-output)	
Rated insulation voltage	480VAC
CONNECTIONS	
Maximum tightening torque	0.8Nm (7lb.in; 7-9lb.in according to UL/CSA)
Conductor section min....max.	0.2...4.0mm ² (24...12AWG; 18...12AWG according to UL/CSA)
AMBIENT CONDITIONS	
Operating temperature	-20...+60°C
Storage temperature	-30...+80°C
HOUSING	
Material	Self-extinguishing polyamide

❶ UL/CSA certification obtained with 415VAC maximum.

26 Automatic power factor controllers and thyristor modules

Technical characteristics DCRL... and DCRG series automatic power factor controllers

TYPE	DCRL3	DCRL5	DCRL8	DCRG8 / DCRG8IND	DCRG8F
AUXILIARY SUPPLY CIRCUIT					
Rated supply voltage (Us)	100...440VAC			100...415VAC	
Operating range	90...484VAC			90...456VAC	
Rated frequency	50Hz; 60Hz			50Hz; 60Hz	
Maximum power consumption	9.5VA		7VA	27VA	
Maximum power dissipation (excluding power dissipation from the output contacts)	3.5W		2.5W	10.5W	
VOLTAGE CIRCUIT					
Control voltage	100...600VAC L-L; 100...346VAC L-N			100...600VAC L-L; 100...346VAC L-N	
Operating range	50...720VAC L-L; 50...415VAC L-N			50...720VAC L-L; 50...415VAC L-N	
Frequency range	45...66Hz			45...66Hz; 360...440Hz	
Immunity time for microbreaking	<25ms			35ms (110VAC) - 80ms (220...415VAC)	
No-voltage relay release	≥8ms			≥8ms	
CURRENT CIRCUIT					
Rated current Ie	Programmable 5A or 1A				
Operating range	0.025...6A for 5A full scale; 0.025...1.2A for 1A full scale				
Constant overload	1.2Ie				
Overload peak	50A for 1 second				
Power consumption	0.6VA				
MEASUREMENT DATA					
Type of voltage and current measurement	True RMS value				
Power factor adjustment	0.5ind....0.5cap.				
Type of temperature sensor type	Internal			Internal + PT100 with EXP1004 + NTC with EXP1016 (DCRG8 / DCRG8IND)	
Temperature measurement range	0...+212°C			0...+212°C	
RELAY OUTPUTS					
Number of outputs	3 (up to 6 with EXP1006 - EXP1007)	5 (up to 8 with EXP1006 - EXP1007)	8 (up to 14 with EXP1006 - EXP1007)	8 (up to 18 with EXP1006 - EXP1007)	0 (up to 10 with EXP1006 - EXP1007)
Contact arrangement	2 NO contacts + 1 changeover	4 NO contacts + 1 changeover	7 NO contacts + 1 changeover	7 NO contacts + 1 changeover	—
IEC rated current	5A 250V AC1			5A 250V AC1	
Maximum current at common contact terminal	10A				
Maximum switching voltage	415VAC				
IEC/EN/BS 60947-5-1 and UL/CSA designation	B300				
Electrical life with rated load	10 ⁵ cycles				
Mechanical life	30x10 ⁶ cycles				
STATIC OUTPUTS					
Number of outputs	—			4 or 8 with EXP1001 (55mA)	8 (120mA) (up to 24 with EXP1001)
INSULATION					
Rated insulation voltage Ui	600VAC				
Rated impulse withstand voltage Uimp	9.5kV				
Power frequency withstand voltage	5.2kV				
CONNECTIONS					
Type of terminal	Removable				
Conductor section min....max	0.2...2.5mm ² (24...12AWG; 18...12AWG according to UL)				
AMBIENT CONDITIONS					
Operating temperature	-20...+60°C			-20...+70°C	
Storage temperature	-30...+80°C			-30...+80°C	
HOUSING					
Version	Flush-mount 96x96mm (3.78x3.78")			Flush-mount 144x144mm (5.67x5.67")	
Material	Polycarbonate			Polycarbonate	
IEC degree of protection	IP54			IP65	

26 Automatic power factor controllers and thyristor modules

Technical characteristics
Thyristor modules DCTL...

TYPE	DCTLA 4000075	DCTLA 4000150	DCTLA 4000300	DCTLA 4000500	DCTLA 4001000	DCTLA 4800090	DCTLA 4800180	DCTLA 4800360	DCTLA 4800600	DCTLA 4801200	DCTLA 6900300	DCTLA 6900500	DCTLA 6901000	
Rated operating voltage Us	400VAC					400...480VAC					600...690VAC			
Rated frequency	50/60Hz													
Rated current Ie	11A	22A	43A	72A	144A	11A	22A	43A	72A	144A	29A	48A	96A	
Step power	400VAC	7.5kvar	15kvar	30kvar	50kvar	100kvar	7.5kvar	15kvar	30kvar	50kvar	100kvar	20kvar	33kvar	67kvar
	440VAC	-	-	-	-	-	8kvar	16.5kvar	33kvar	55kvar	110kvar	22kvar	37kvar	73kvar
	480VAC	-	-	-	-	-	9kvar	18kvar	36kvar	60kvar	120kvar	24kvar	40kvar	80kvar
	525VAC	-	-	-	-	-	-	-	-	-	-	26kvar	44kvar	87kvar
	600VAC	-	-	-	-	-	-	-	-	-	-	30kvar	50kvar	100kvar
	690VAC	-	-	-	-	-	-	-	-	-	-	30kvar	50kvar	100kvar
Peak Inverse Voltage (PIV)	1800VAC					2200VAC					3600VAC			
Number of controlled phases	2													
Auxiliary supply	100...240VAC													
Control circuit	8...30VDC or dry contact or via RS485 serial port (with optional card EXC1042 in combination with controller DCRG8F + EXP1012)													
Over-temperature protection	Yes, via integrated probe or optional external probe NTC01													
Cooling	Forced ventilation													
Operating temperature	-20...+45°C without derating (up to 55°C with derating)❶													

❶ Consult our Technical support for more information; see contact details on front cover.

THYRISTOR MODULES

DCTL

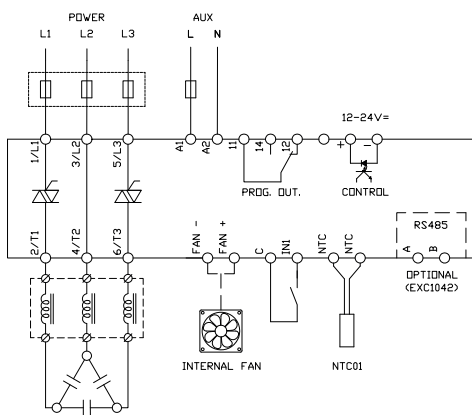



- Supervision of two or three-phase power sources
- Emergency demand supervision for standby generating set
- Tie-breaker management
- Control of contactors, motorised circuit breakers and motorised changeover switches
- Closed transition
- Automatic non-priority load management
- Event logging
- Remote control and supervision
- Front optical port
- Built-in NFC technology
- Expandable with EXP modules
- Communication protocols Modbus-ASCII, RTU and TCP
- Real time clock
- Enclosed automatic transfer switches ATS.

Automatic transfer switch controllers for 2 power sources

ATL100 type modular version for controlling 2 power sources with single-phase control	27 - 7
ATL500 type non expandable with synoptic and NFC for controlling 2 power sources	27 - 7
ATL600 and ATL601 type non expandable for controlling 2 power sources.....	27 - 8
ATL610 type expandable with EXP modules for controlling 2 power sources	27 - 8
ATL800 type expandable with EXP modules for controlling 2 power sources and 1 tie breaker	27 - 9

Automatic transfer switch controllers for 3 power sources

ATL900 type expandable with EXP modules for controlling 3 power sources and 2 tie breakers	27 - 10
--	---------

Enclosed automatic transfer switches ATS

ATP series with ATL600 automatic transfer switch controller and contactors	27 - 11
--	---------

Accessories

Dual power supply module	27 - 12
Communication devices, software and accessories	27 - 13

Dimensions

27 - 14

Wiring diagrams

27 - 15

Technical characteristics

27 - 18

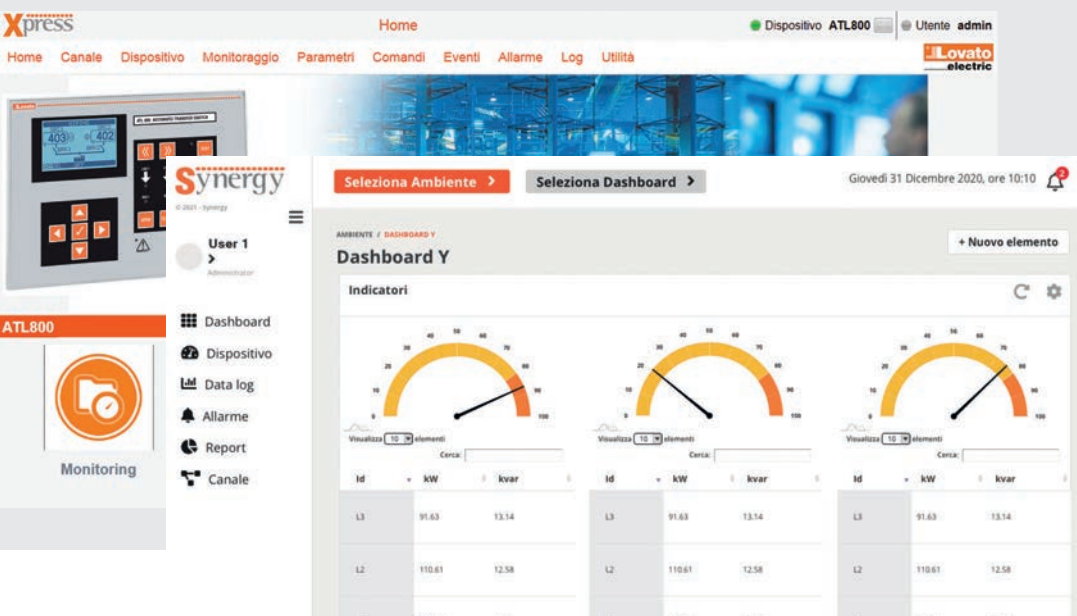



Page 27-7

ATL100

- Modular housing
- Management of two power sources
- Single-phase control.



Page 27-7

ATL500

- Management of two power sources
- Self-seeking power supply
- 2 programmable digital inputs
- 3 programmable digital outputs
- Built-in NFC technology for parameter settings with App **NFC**.



Page 27-8

ATL600 - ATL601

- Management of two power sources
- AC power supply
- 6 programmable digital inputs
- 7 programmable relay outputs.



Page 27-8

ATL610

- Management of two power sources
- AC and DC power supply
- 6 programmable digital inputs
- 7 programmable relay outputs
- Real time clock (RTC)
- Expandable with EXP series modules (inputs and outputs, communication ports).



Page 27-9

ATL800

- Management of 2 power sources and 1 tie breaker
- AC and DC power supply
- 8 programmable digital inputs
- 7 programmable relay outputs
- Built-in NFC technology for parameter settings with App **NFC**
- Real time clock (RTC)
- Non-priority load management
- Closed transition with brief parallel configuration
- Built-in RS485 communication
- Built-in PLC logic
- Expandable with EXP series modules (inputs and outputs, communication ports).



Page 27-10

ATL900

- Management of 3 power sources and 2 tie breakers
- AC and DC power supply
- 12 programmable digital inputs
- 4 current inputs
- 10 programmable relay outputs
- 1 programmable static output
- Built-in NFC technology for parameter settings with App **NFC**
- Real time clock (RTC)
- Non-priority load management
- Closed transition with brief parallel configuration
- Built-in RS485 communication
- Built-in PLC logic
- Expandable with EXP series modules (inputs and outputs, communication ports).



Page 27-11

ATP

- Enclosed automatic transfer switches from 45 to 160A
- Management of 2 power sources
- Four-pole interlocked contactors
- Automatic transfer switch controller type **ATL600**
- Dual power supply module type **ATLDPS1** for the measurement and control of voltages present at supply inputs
- Miniature circuit breakers for the protection of the measuring lines
- Metallic enclosure IP65.



Page 27-12

ATLDPS1

- Module specifically designed to control power supply voltage of motorised circuit breakers and changeover switches
- Continuous monitoring of supply line status
- Management via microcontroller management.

SIMPLE AND READY TO USE

SYNOPTIC

The frontal synoptic provides a simple and clear view of the status of the plant, signalling with LEDs the status of the power sources and the status of the changeover devices.

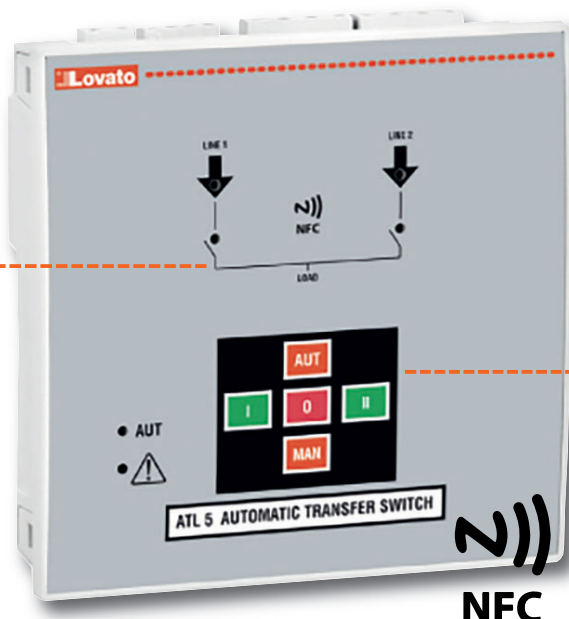

FRONTAL KEYBOARD

With the frontal keyboard it is possible to select the operating mode (manual or automatic) and command manually the switching between the power sources directly with the buttons I-O-II on the front, without need to program any setting on the controller.

SELF-SEEKING POWER SUPPLY

ATL500 has a self-seeking power supply, which automatically selects the best of the two available power sources for the internal supply, taken directly from the two measuring inputs (rated voltage 110...240VAC L-N), without the need of an external circuit or dual power supply module for the selection of the power for the auxiliary supply.

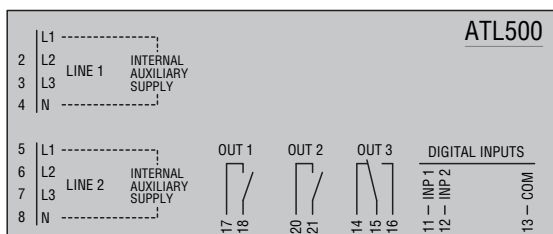

THREE-PHASE WITH NEUTRAL VOLTAGE MONITORING INPUTS

ATL500 is provided with three-phase with neutral voltage monitoring inputs for a complete monitoring of the voltage and frequency of both power sources. The controller can be configured to be used in three-phase with neutral, single-phase or two-phase systems.

PROGRAMMABLE DIGITAL INPUTS AND OUTPUTS

The function of the programmable digital inputs and outputs can be configured via NFC to satisfy different application needs.

HIGH PROTECTION DEGREE

The controller front and the optional frame seal have been designed to warrant an IP65 protection degree.

NFC CONNECTION

ATL500 is provided with built-in NFC connectivity for the programming via Android and iOS smart devices (smartphone and tablets) with the LOVATO NFC App in a simple, fast and innovative way, which does not need any connection cable and is able to operate even without power supply on the controller.

With the LOVATO NFC App it is possible to configure:

- system parameters: rated system voltage, rated frequency, type of wiring, voltage control mode, etc.
- password for the protection of the access to the settings
- changeover settings: priority line selection, interlock times, feedback delays, etc.
- protection thresholds and tripping delays: min/max voltage, min/max frequency, phase sequence, asymmetry
- function of the programmable digital inputs and outputs
- function of the potentiometers
- alarms properties.

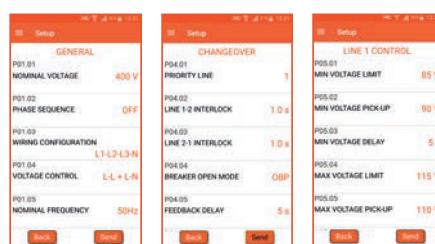

POTENTIOMETERS

ATL500 is provided with two potentiometers on the back, one for each power source, which can be used for the manual setting of the line presence delays (default setting) or to set the tripping delays of the protection thresholds, in alternative to the setting via NFC. The function of the potentiometers can be modified with the LOVATO NFC App.

LINE 1
0...60 sec

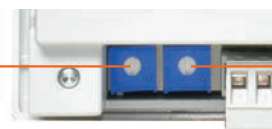

LINE 2
0...60 sec

27 Automatic transfer switch controllers

For 2 power sources.
ATL600 - ATL601 - ATL610

NON-STOP CONTROL!

- **BACKLIT GRAPHIC LCD DISPLAY**
128x80 pixel, with excellent legibility with adjustable brightness and display of events, alarms and measurements in 5 languages: English, Italian, French, Spanish and German.

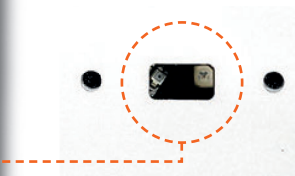

- **OPTICAL COMMUNICATION PORT**

The optical port on the front, using a standard USB or Wi-Fi point, permits to communication with a PC, smartphone and tablet, to carry out programming, diagnostics and data download without removing power to the electric panel.

- **COMPACT SIZE**

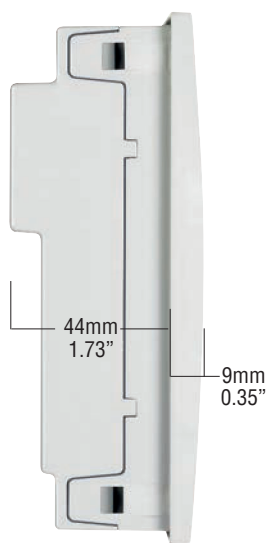

Slim frame profile and reduced total depth simplify installation of the transfer switch controller also in very compact electric panels.

- **HIGH PROTECTION DEGREE**
The controller front and the optional frame seal have been designed to warrant an **IP65** protection degree.
- **MAINTENANCE COUNTERS**
ATL features two counters used for maintenance; the first monitors the operating time and the second counts the number of switching operations. Exceeding the limit set on the counters activates the corresponding alarm.

- **FIXING SYSTEM**



The fixing system with **metal screws** guarantees excellent, lasting hold over time.

- **STATISTICS AND EVENTS**
The recorded statistical data is available to the user for understanding how the system operates. A cyclical internal memory records up to 100 events.
- **EMERGENCY DEMAND SUPERVISION FOR STANDBY GENERATING SET**
In applications where one of the two supply sources is a generating set, the transfer switch controller has specific functions to supervise the generator starting and stopping operations.

- **INPUTS, OUTPUTS, INTERNAL VARIABLES, COUNTERS**

The inputs and outputs can be configured by the user to manage the various application requirements. Also available to the user are limit thresholds, counters, user alarms and remote control variables (ATL610 only) to customise the control functions. The limit and counter statuses, if enabled, are shown in the appropriate pages on the display.

- **CALENDAR CLOCK (ATL610)**
Built-in calendar-clock with backup reserve power.
- **DUAL POWER SUPPLY (ATL610)**
110...240VAC and 12/24VDC supply.
- **EXPANDABILITY (ATL610)**
Basic functions of the transfer switch controllers can be easily extended using EXP series expansion modules:
 - Relay outputs
 - Digital and analogue inputs and outputs
 - Opto-isolated RS232 interface
 - Opto-isolated RS485 interface
 - Opto-isolated Ethernet interface.
 Using modules dedicated to communications the device can be controlled and supervised by the **Synergy** and **Synergy** softwares and controlled remotely and configured with the **Xpress** software.

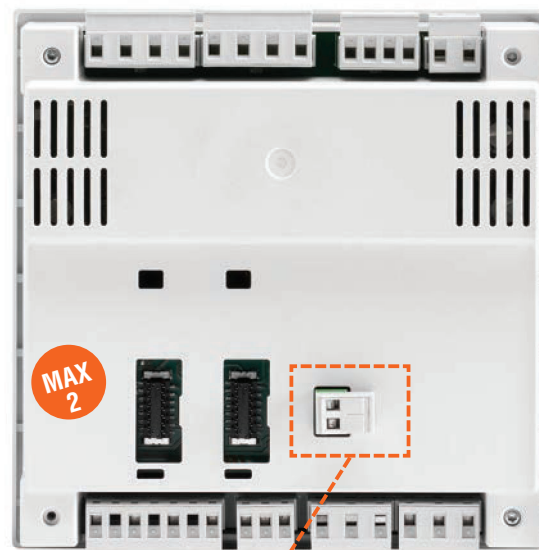

12/24VDC battery supply input (only for ATL601 and ATL610)

VERSATILE CONFIGURATION



ATL800

- Management of 2 energy sources and 1 tie breaker.
- 6 preconfigured system layouts.
- Non-priority load management.
- Management of transition with brief parallel configuration.
- RS485 built-in.
- Built-in NFC technology for parameter settings with App **NFC**.
- App and software: **Synergy**, **Xpress**, **Sam1**, **NFC**.

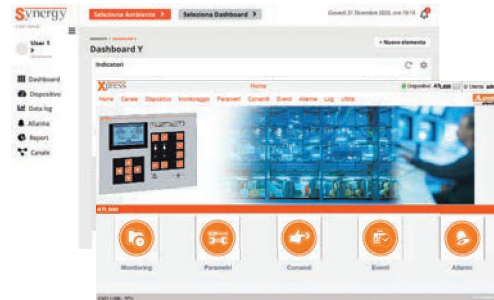

● GRAPHIC LCD AND 8 LANGUAGE TEXT

The backlit graphic display simplifies the user interface and permits good visibility in environments with poor lighting. For ATL800 and ATL900 the texts are available in 8 languages: English, Italian, French, Spanish, German, Portuguese, Polish and Russian.

The new interface allows the user to see, clearly and simply:

- System status
- Measurements
- Statistical data
- Threshold control
- Alarm pop-up windows.

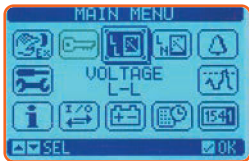

● MAINTENANCE COUNTERS

Two counters can be used for scheduling maintenance on the transfer systems installed: the first for recording the operating time and the second for monitoring the number of switching operations. Exceeding the limit set on the counters activates the corresponding alarm.

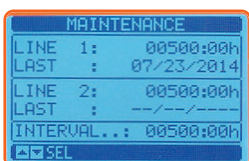

● INPUTS, OUTPUTS, INTERNAL VARIABLES, COUNTERS

The input and output functions are preconfigured with the most frequently used settings; the user can easily modify the predefined configuration and adapt the switch to their application requirements. All the inputs and outputs can be configured. There are various types of programmable internal variables:

- Limit thresholds
- Remote control variables
- User alarms
- Programmable counters
- Timer.

The limit, counter and enabled timer statuses are available for display on dedicated pages.

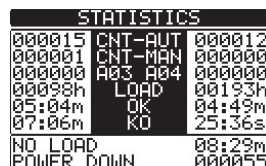
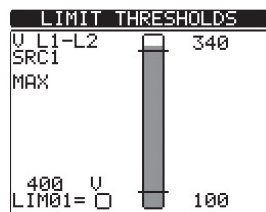

● HIGH PROTECTION RATING

The controller front and the frame seal have been designed to warrant an **IP65** protection degree.

● STATISTICS AND EVENTS

The statistical data recorded by the transfer switch controller is available to the user for analysing the performance of the switching system. A cyclical internal memory records up to 250 events, providing useful information on the history of the system controlled.

● BUILT-IN CALENDAR CLOCK

A built-in calendar clock with backup reserve energy permits each event to be identified using the time and date on which it occurred.

● BUILT-IN RS485 COMMUNICATION

Thanks to the built-in RS485 communication port, ATL800 and ATL900 are already set up for remote supervision and control. In addition to this communication port, the user can install two further types of communication from those available in the EXP... expansion modules.

● DUAL AC/DC SUPPLY

ATL switches can deal with all supply solutions demanded by the market. The best and safest solution is the simultaneous use of AC and DC supply. The switches can then be supplied by the AC line available and, during switching, in the absence of the AC line, the switch will be supplied by the battery via the DC inputs. Non-stop control! AC supply ensures supply during system monitoring and DC supply guarantees constant supply during switching.

● PROGRAMMABLE PLC LOGIC

With the built-in PLC functions, new switching logic can be defined through appropriate combinations of input, output and internal variable signals.

● TIMER

8 timer variables are available for use in the system's PLC logic, in combination with the outputs or user alarms. Each timer variable has an input variable that controls it. When this variable changes state, so does the timer variable, but it remains in the new state only for the time specified then returns automatically to the starting condition.

● NFC CONNECTION

Programming the parameters via tablet and smartphone is now possible also through NFC wireless technology. Bringing a smartphone or tablet with NFC connection enabled close to the display of the ATL800-900 activates the **NFC** App LOVATO and the switch connected is recognised automatically. It will then be possible to modify the parameters and program the ATL.

● USB AND WI-FI COMMUNICATION INTERFACES

ATL800 and ATL900 feature a front optical port for programming via optional USB (CX01) or Wi-Fi (CX02) communication interface.

Advantages:

- Not necessary to disconnect the supply from the panel to connect to the switch
- Electrical safety (no physical connection)
- Convenience of operating on the front.

27 Automatic transfer switch controllers

For 2 and 3 power sources.
ATL800 - ATL900

FULL OPTIONAL, FOR EVERY REQUIREMENT



ATL900

- Management of 3 energy power sources and 2 tie breakers.
- 4 current inputs for the three-phases and neutral.
- 14 preconfigured system layouts.
- Non-priority load management.
- Management of transition with brief parallel configuration.
- RS485 built-in.
- Built-in NFC technology for parameter settings with App **NFC**.
- App and software: **Synergy**, **Xpress**, **Sam1**, **NFC**.

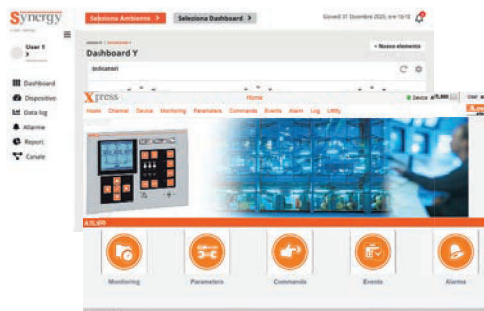

● WI-FI COMMUNICATION INTERFACE (VIA CX02)

This connection can be used to:

- Copy the parameters
All the parameters of the ATL can be saved in the CX02 memory and if necessary loaded back into the same device (backup function) or a new switch (replication of the configuration).
- Clone the device settings
In addition to copying the parameters, the current values of the statistical data, counters and events can be saved in the memory in order to completely replicate an ATL on another device of the same type or restore the ATL to a previously saved state.

THREE TYPES OF TRANSITION AVAILABLE

Open transition

The switch transfers the load between the two sources, interrupting the supply for a period of time that can be programmed by the user.

In-phase transition

The switch transfers the load between the two sources, interrupting the supply for a period of time that can be programmed. In this case the load is passed to a new source if spontaneous synchronisation is found; the amplitude, phase and frequency of the two sources must not differ from the maximum value set.

Closed transition

With switches and external protections, configured appropriately, the two sources will be synchronised (where possible) or spontaneous synchronisation will be expected within a limit time. In presence of all synchronisation conditions the load will be transferred with closed transition and instantaneous parallel without interrupting supply.

ATL900: management of three sources and two tie breakers

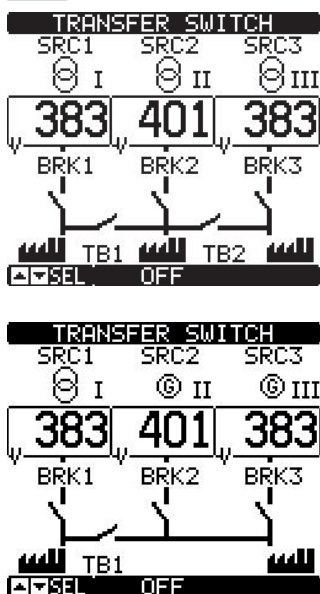

A single transfer switch controller can be used to manage applications which in the past required several transfer switch controllers in a cascade connection. 24 system layouts are available.

4 current inputs

The current inputs permit the monitoring of the demand load and defining of the correct switching strategy. Knowing the power demanded by the system and the rated power of the sources, ATL900 can select the best source available that can supply the loads correctly.

● EXPANDABILITY

ATL800 and ATL900 functionality can be extended thanks to the EXP... series expansion modules. Three expansion slots are available, and while the switch is restarting the modules are recognised and configured entirely automatically. The following EXP... modules are available:

- Digital I/O modules
- Analogue I/O modules
- USB, RS232, RS485, Ethernet and Profibus communication modules
- GPRS/GSM modem

Since the additional modules are shared with other LOVATO Electric products, it is possible to save in management costs, guaranteeing flexibility and ease of installation, above all when the system has already been commissioned.



EXP10...



MAX
3



	ATL100	ATL500	ATL600 - ATL601	ATL610	ATL800	ATL900
POWER SUPPLY						
Rated DC supply voltage	—	—	12/24VDC (ATL601)	12/24VDC	12/24/48VDC	12/24/48VDC
Rated AC supply voltage	110...230VAC	110...240VAC (self-powered)	110...240VAC (ATL600)	110...240VAC	110...240VAC	110...240VAC
Frequency	45...66Hz	45...66Hz	45...66Hz (ATL600)	45...66Hz	45...66Hz	45...66Hz
FRONT PANEL / HOUSING						
Backlit display	—	—	LCD graphic 128x80 pixel	LCD graphic 128x80 pixel	LCD graphic 128x80 pixel	LCD graphic 128x112 pixel
Languages	—	—	5	5	8	8
Size	Modular housing (3U)	144x144x52.2mm/ 5.67x5.67x2.05"	144x144x52.2mm/ 5.67x5.67x2.05"	144x144x52.2mm/ 5.67x5.67x2.05"	240x180x45mm/ 9.45x7.09x1.77"	240x180x45mm/ 9.45x7.09x1.77"
Degree of protection	IP40 on front / IP20 terminals	IP40 / optional IP65	IP40 / optional IP65	IP40 / optional IP65	IP65	IP65
Expandable with EXP... series modules	—	—	—	2 modules	3 modules	3 modules
VOLTAGE AND CURRENT MEASUREMENT INPUT						
Power sources that can be controlled	—	2	2	2	2	3
Voltage inputs per line	1 phase + neutral	3 phases + neutral	3 phases + neutral	3 phases + neutral	3 phases + neutral	3 phases + neutral
Rated voltage Ue	110...230VAC	110...240VAC L-N	480VAC	480VAC	600VAC	600VAC
Current inputs	—	—	—	—	—	4 (by 5A or 1A CTs)
Frequency range	45...66Hz	45...66Hz	45...66Hz	45...66Hz	45...66Hz	45...66Hz
BUILT-IN DIGITAL INPUTS AND OUTPUTS						
Number of inputs	—	2	6	6	8	12
Number of outputs	3	3	7	7	7	11
Contact configuration	3 NO	2 NO + 1 changeover	6 NO + 1 changeover	6 NO + 1 changeover	4 NO + 3 changeover	6 NO + 4 changeover + 1 SSR
INTERFACE						
Programming with NFC technology	—	●	—	—	●	●
Front optical USB communication port	—	—	● with CX01	● with CX01	● with CX01	● with CX01
Front optical Wi-Fi communication port	—	—	● with CX02	● with CX02	● with CX02	● with CX02
USB communication	—	—	—	● EXP1010	● EXP1010	● EXP1010
RS232 communication	—	—	—	● EXP1011	● EXP1011	● EXP1011
RS485 communication	—	—	—	● EXP1012	● (built-in)	● (built-in)
Ethernet communication	—	—	—	● EXP1013	● EXP1013	● EXP1013
Profibus communication	—	—	—	● EXP1014	● EXP1014	● EXP1014
Communication via Modem	—	—	—	—	● EXP1015	● EXP1015
FUNCTIONS						
Number of tie breakers that can be managed	—	—	—	—	1	2
Programmable source type (utility or generation)	—	●	●	●	●	●
Closed transition	—	—	—	—	●	●
Non-priority load management	—	—	—	—	●	●
Switching management with power thresholds	—	—	—	—	—	●
PLC logic	—	—	—	—	●	●
Timers	—	—	—	—	●	●
System layout available on display	—	—	—	—	6	14
Custom system layouts	—	—	—	—	●	●
User alarms	—	—	●	●	●	●
Limits	—	—	●	●	●	●
Counters	—	—	●	●	●	●
Event logging	—	—	100	100	250	250
Real time clock with backup reserve energy	—	—	—	●	●	●
Acoustic alarms	—	—	—	—	●	●
Analogue inputs	—	—	—	—	● EXP1004	● EXP1004
Analogue outputs	—	—	—	—	● EXP1005	● EXP1005
Accessory for remote alarm status	—	—	—	—	—	● RGKRR

27 Automatic transfer switch controllers

For 2 power sources

Non expandable modular



ATL100

Order code	Description	Qty per pkg	Wt
		n°	[kg]
ATL100	Automatic transfer switch controller for 2 power sources with single-phase control, modular housing, 110...230VAC supply	1	0.300

General characteristics ATL100

ATL100 is a single-phase automatic transfer switch controller in modular housing. It monitors 2 single-phase voltage inputs and it connects to the output the line that is within the limits. The priority line is the line 1. The 2 outputs can control contactors or motorized changeover switches to perform the transfer between the lines.

Operational characteristics ATL100

- Self-powered
- Input voltage range: 80...300VAC
- Frequency range: 45...66Hz
- 2 relay outputs with 1 NO contact 4A 250VAC
- 1 relay output with 1 NO contact 3A 250VAC.

Non expandable flush-mount



ATL500

new



Order code	Description	Qty per pkg	Wt
		n°	[kg]
ATL500	Automatic transfer switch controller with NFC technology and synoptic, for 2 power sources with three-phase control (144x144mm/5.7x5.7"), self-seeking power supply 110...240VAC	1	0.580

General characteristics ATL500

ATL500 is an automatic transfer switch controller for the automatic or manual switching of the load from the MAIN LINE to a stand-by or emergency SECONDARY LINE and vice versa.

With the integrated outputs, it is possible to control contactors or motorized changeover switches.

The main features are:

- Self-seeking power supply from the two measurement inputs
- Measurement inputs for three-phase + neutral voltage values, also suitable for 1 and 2 phase lines
- Synoptic on front with LEDs for a simple and clear visualisation of the status of the lines and the changeover devices
- Parameter programming via NFC technology and **NFC App** LOVATO downloadable from Google Play Store and App Store. With **NFC App** LOVATO is possible to set: rated system parameters, line control settings, changeover settings, password and I/O functions
- Frontal keyboard for the selection of the operating mode and the manual command of the changeover devices
- 2 programmable digital inputs
- 3 programmable relay outputs
- Potentiometers on the back for the manual setting of the line presence delays or the tripping delays of the protection thresholds.

Operational characteristics ATL500

- Power supply:
 - Self-seeking power supply from the measurement inputs 110...240VAC L-N (range: 90...300VAC L-N)
- Voltage measurement inputs:
 - Rated voltage U_e : 110...240VAC L-N / 190...415VAC L-L
 - Measuring range: 90...300VAC L-N / 155...519VAC L-L
 - Frequency range: 45...66Hz
- Programmable digital inputs:
 - Negative inputs
- Programmable relay outputs:
 - 2 each with 1 normally open contact (NO - SPST) rated 8A 250VAC
 - 1 with 1 changeover contact (NO/NC - SPDT) rated 8A 250VAC
- Enclosure:
 - Flush-mount housing: 144x144mm/5.7x5.7"
 - IEC degree of protection: IP40 on front; IP65 with optional seal EXP8001; IP20 at rear.

Certifications and compliance

Certifications obtained: EAC, RCM (only for ATL500).
Compliant with standards: IEC/EN/BS 61010-1, IEC/EN/BS 61010-2-030, IEC/EN/BS 60947-1, IEC/EN/BS 60947-6-1, IEC/EN/BS 61000-6-2, IEC/EN/BS 61000-6-3.

Accessories



EXP8001

Order code	Description	Qty per pkg	Wt
		n°	[kg]
EXP8001	IP65 gasket seal for ATL500/600/601/610	1	0.009

Non expandable



ATL600

Order code	Description	Qty per pkg	Wt
		n°	[kg]
ATL600	Automatic transfer switch controller with LCD display and optical port for 2 power sources with three-phase control (144x144mm/5.7x5.7"), 110...240VAC supply	1	0.600
ATL601	Automatic transfer switch controller with LCD display and optical port for 2 power sources with three-phase control (144x144mm/5.7x5.7"), 12...24VDC supply	1	0.600

Expandable with EXP... modules



ATL610

Order code	Description	Qty per pkg	Wt
		n°	[kg]
ATL610	Automatic transfer switch controller with LCD display and optical port for 2 power sources with three-phase control (144x144mm/5.7x5.7"), 110...240VAC and 12/24VDC, supply expandable with EXP... series modules	1	0.680



EXP10...

Order code	Description
EXPANSION MODULES FOR ATL610 Snap on fixing of two modules on ATL610 rear. Inputs and outputs.	
EXP1000	4 opto-isolated digital inputs
EXP1001	4 opto-isolated static outputs
EXP1002	2 digital inputs and 2 static outputs, opto-isolated
EXP1003	2 relay outputs with changeover contact 5A 250VAC
EXP1006	2 relay outputs, normally open contact 5A 250VAC
EXP1007	3 relay outputs, normally open contact 5A 250VAC
EXP1008	2 opto-isolated digital inputs and 2 5A relay outputs, normally open contact 250VAC
Communication ports.	
EXP1010	Opto-isolated USB interface
EXP1011	Opto-isolated RS232 interface
EXP1012	Opto-isolated RS485 interface
EXP1013	Opto-isolated Ethernet interface
EXP1014	Opto-isolated Profibus-DP interface

EXP... expansion modules fixing on ATL610



General characteristics ATL600 - ATL601 - ATL610

The automatic transfer switch controllers ATL600 / ATL601 / ATL610 are used for the automatic or manual switching of the load from the MAIN LINE to a stand-by or emergency SECONDARY LINE and vice versa. They have two outputs for the "automatic" and/or "manual" control of contactors or motorised circuit breakers and switches.

The main features are:

- Supply input:
 - Single in AC for ATL600
 - Single in DC for ATL601
 - Dual in AC and DC for ATL610
- Measurement inputs for three-phase + neutral voltage values; also suitable for 1 and 2 phase lines
- 128x80 pixel backlit graphic LCD to view measurements, events and alarms in 5 languages (English, Italian, French, Spanish and German)
- 2 status indication LEDs
- 6 programmable digital inputs
- 7 programmable relay outputs
- Viewing of L-L and L-N voltage values of the controlled lines
- Status viewing of contactor or motorised circuit breakers and switches
- Configuration programming of lines, control and supervision parameters for emergency demand of generating set
- Event logging
- Microprocessor supervision of functions; including virtual real time clock for ATL610
- Communication interface by front optical port with CX01 or CX02 dongle using USB or Wi-Fi
- Compatible with **Synergy**, supervision and energy management software, **Xpress** remote control and configuration software and with the **Satmi** application for Android/iOS
- Modbus-RTU, ASCII and TCP communication protocol.

CONTROL FUNCTIONS OF THE LINES

- Phase sequence and phase loss
- Minimum and maximum voltage
- Voltage asymmetry
- Minimum and maximum frequency.

Operational characteristics ATL600 - ATL601 - ATL610

- Power supply:
 - Power supply voltage: 110...240VAC (ATL600); 12/24VDC (ATL601); 12/24VDC - 110...240VAC (ATL610)
- Voltage measurement inputs:
 - Rated voltage Ue: 100...480VAC (L-L)
 - Measuring range: 50...576VAC (L-L)
 - Frequency range: 45...66Hz
- Programmable digital inputs:
 - Negative inputs
- Programmable relay outputs:
 - 6 each with 1 normally open contact (NO - SPST) rated 8A 250VAC
 - 1 with changeover contact (NO/NC - SPDT) rated 8A 250VAC
- Enclosure:
 - Flush-mount housing: 144x144mm/5.7x5.7"
 - IEC degree of protection: IP40 on front; IP65 with optional seal EXP8001; IP20 at rear.

Certifications and compliance

Certifications obtained: cULus, RCM, LOVAG (only for ATL600 - ATL610), EAC.
Compliant with standards: IEC/EN/BS 61000-6-3 (only for ATL601), IEC/EN/BS 61000-6-4 (only for ATL600 - ATL610), IEC/EN/BS 60947-1, IEC/EN/BS 60947-6-1, IEC/EN/BS 61000-6-2, IEC/EN/BS 61000-6-3, UL508, CSA C22.2 n° 14.

Expandable with EXP... modules



ATL800



EXP10...

Order code	Description	Qty per pkg	Wt
		n°	[kg]
ATL800	Automatic transfer switch controller (240x180mm/9.45"-7.09") with LCD display, optical port and NFC for 2 lines control and 1 tie breaker, 110...240VAC supply and 12/24/48VDC, expandable with EXP... series modules	1	1.000

Order code	Description
EXPANSION MODULES. Snap on fixing of three modules on rear of ATL800 . Digital inputs and outputs.	
EXP1000	4 opto-isolated digital inputs
EXP1001	4 opto-isolated static outputs
EXP1002	2 digital inputs and 2 static outputs, opto-isolated
EXP1003	2 relay outputs 5A 250VAC, changeover contact
EXP1006	2 relay outputs, normally open contact 5A 250VAC
EXP1007	3 relay outputs, normally open contact 5A 250VAC
EXP1008	2 opto-isolated digital inputs and 2 5A relay outputs, normally open contact 250VAC
Analogue inputs and outputs.	
EXP1004	2 opto-isolated analogue inputs 0/4...20mA or PT100 or 0...10V or 0...+5V
EXP1005	2 opto-isolated analogue outputs 0/4...20mA or 0...10V or 0...+5V
Communication ports.	
EXP1010	Opto-isolated USB interface
EXP1011	Opto-isolated RS232 interface
EXP1012	Opto-isolated RS485 interface
EXP1013	Opto-isolated Ethernet interface
EXP1014	Opto-isolated Profibus-DP interface

EXP... expansion module fixing on ATL800



MAX 3

General characteristics

The automatic transfer switch controller **ATL800** is used for the automatic or manual switching of the load between two lines in accordance with the selected switching logic. It has outputs for the "automatic" and/or "manual" control of contactors or motorised circuit breakers and switches. It can also manage a third control device as tie breaker or non-priority load management. The layout and system status are displayed directly on the graphic LCD.

The main features are:

- AC and DC supply inputs
- Measurement inputs for three-phase + neutral voltage values; also suitable for 1 and 2 phase lines
- 128x80 pixel backlit graphic LCD to view measurements, events and alarms in 8 languages (English, Italian, French, Spanish, German, Portuguese, Polish and Russian)
- Active operating mode indicator LED
- Viewing of L-L and L-N voltage values of the controlled lines
- Viewing the status of contactors or motorised circuit breakers both via display and LED
- 6 system layouts available
- Management of a tie breaker
- 8 programmable digital inputs
- 7 programmable relay outputs
- Viewing of L-L and L-N voltage values of the controlled lines
- Configuration programming of lines, type of source (line/generator), control and supervision parameters for emergency demand of generating set
- Possibility of transferring load with closed transition and spontaneous or controlled genset synchronisation
- Non-priority load management
- Built-in programmable PLC logic
- Built-in RS485 communication
- Event logging
- Virtual calendar clock (RTC)
- Communication interface by front optical port with CX01 or CX02 dongle using USB or Wi-Fi
- Parameter programming via NFC technology and the App **NFC** downloadable from Google Play Store and App Store
- Compatible with **Synergy**, supervision and energy management software, **Xpress** remote control and configuration software and with the **Sam1** application for Android/iOS
- Modbus-RTU, ASCII and TCP communication protocol.

CONTROL FUNCTIONS OF THE LINES

- Phase sequence and phase loss
- Minimum and maximum voltage
- Voltage asymmetry
- Minimum and maximum frequency.

Operational characteristics

- Power supply:
 - Power supply voltage: 100...240VAC; 12/24/48VDC
- Voltage measurement inputs:
 - Rated voltage U_e : 100...600VAC (L-L)
 - Frequency range: 45...66Hz
- Programmable digital inputs:
 - Negative inputs
- Programmable relay outputs:
 - 2 each with 1 normally open contact (NO - SPST) rated 12A 250VAC
 - 2 each with 1 normally open contact (NO - SPST) rated 8A 250VAC
 - 3 each with 1 changeover contact (NO/NC - SPDT) 8A 250VAC
- Enclosure:
 - Flush-mount housing: 180x240mm/7.09x9.45"
 - IEC degree of protection: IP65 on front; IP20 at back.

Certifications and compliance

Certifications obtained: cULus, EAC, RCM, LOVAG. Compliant with standards: IEC/EN/BS 61010-1, IEC/EN/BS 61010-2-030, IEC/EN/BS 61000-6-2, IEC/EN/BS 61000-6-4, IEC/EN/BS 60947-1, IEC/EN/BS 60947-6-1, UL508 and CSA C22.2 n° 14.

Expandable with EXP... modules



ATL900



EXP10...

Order code	Description	Qty per pkg	Wt
ATL900	Automatic transfer switch controller (240x180mm/9.45"-7.09") with LCD display, optical port and NFC for 3 lines control and 2 tie breakers, 110...240VAC supply and 12/24/48VDC, expandable with EXP... series modules	1	1.800 [kg]

Order code	Description
EXPANSION MODULES. Snap on fixing of three modules on rear of ATL900. Digital inputs and outputs.	
EXP1000	4 opto-isolated digital inputs
EXP1001	4 opto-isolated static outputs
EXP1002	2 digital inputs and 2 static outputs, opto-isolated
EXP1003	2 relay outputs 5A 250VAC, changeover contact
EXP1006	2 relay outputs, normally open contact 5A 250VAC
EXP1007	3 relay outputs, normally open contact 5A 250VAC
EXP1008	2 opto-isolated digital inputs and 2 5A relay outputs, normally open contact 250VAC
Analogue inputs and outputs.	
EXP1004	2 opto-isolated analogue inputs 0/4...20mA or PT100 or 0...10V or 0...+5V
EXP1005	2 opto-isolated analogue outputs 0/4...20mA or 0...10V or 0...+5V
Communication ports.	
EXP1010	Opto-isolated USB interface
EXP1011	Opto-isolated RS232 interface
EXP1012	Opto-isolated RS485 interface
EXP1013	Opto-isolated Ethernet interface
EXP1014	Opto-isolated Profibus-DP interface
EXP1015	GPRS/GSM modem

EXP... expansion module fixing on ATL900



MAX 3

General characteristics

The automatic transfer switch controller ATL900 is used for the automatic or manual switching of the load between three lines in accordance with the selected switching logic. It has outputs for the "automatic" and/or "manual" control of contactors or motorised circuit breakers and switches. It can also manage two more control devices as tie breakers or non-priority load management. It has four current inputs for managing switching with power thresholds. The layout and system status are displayed directly on the graphic LCD. The main features are:

- AC and DC supply inputs
- Measurement inputs for three-phase + neutral voltage values; also suitable for 1 and 2 phase lines
- 4 current measurement inputs
- 128x112 pixel backlit graphic LCD to view measurements, events and alarms in 8 languages (English, Italian, French, Spanish, German, Portuguese, Polish and Russian)
- Active operating mode indicator LED
- Viewing of L-L and L-N voltage values of the controlled lines
- Viewing the status of contactors or motorised circuit breakers both via display and LED
- 6 system layouts available
- Management of a tie breaker
- 12 programmable digital inputs
- 10 programmable relay outputs
- 1 static output
- Viewing of L-L and L-N voltage values of the controlled lines
- Configuration programming of lines, type of source (line/generator), control and supervision parameters for emergency demand of generating set
- Possibility of transferring load with closed transition and spontaneous or controlled genset synchronisation
- Non-priority load management
- Built-in programmable PLC logic
- Built-in RS485 communication
- Event logging
- Virtual calendar clock (RTC)
- Communication interface by front optical port using USB CX01 or Wi-Fi CX02 dongle
- Parameter programming via NFC technology and the App **NFC** downloadable from Google Play Store and App Store
- Compatible with **Synergy**, supervision and energy management software, **Xpress** remote control and configuration software and with the **Sam1** application for Android/iOS
- Modbus-RTU ASCII and TCP communication protocol.

CONTROL FUNCTIONS OF THE LINES

- Phase sequence and phase loss
- Minimum and maximum voltage
- Voltage asymmetry
- Minimum and maximum frequency.

Operational characteristics

- Power supply:
 - Power supply voltage: 100...240VAC; 12/24/48VDC
- Voltage measurement inputs:
 - Rated voltage Ue: 100...600VAC (L-L)
 - Frequency range: 45...665Hz
- Programmable digital inputs:
 - Negative inputs
- Programmable relay outputs:
 - 3 each with 1 normally open contact (NO - SPST) rated 12A 250VAC
 - 3 each with 1 normally open contact (NO - SPST) rated 8A 250VAC
 - 4 each with 1 changeover contact (NO/NC - SPDT) 8A 250VAC
 - 1 30VDC 50mA static output
- Enclosure:
 - Flush-mount housing: 180x240mm/5.7x5.7"
 - IEC degree of protection: IP65 on front; IP20 at back.

Synergy, **Synergy**, **Xpress**, **Sam1** and **NFC** software and App

See section 29.

EXP expansion modules

See page 30-2.

Certifications and compliance

Certifications obtained: cULus, EAC, RCM, LOVAG. Compliant with standards: IEC/EN/BS 61010-1, IEC/EN/BS 61010-2-030, IEC/EN/BS 61000-6-2, IEC/EN/BS 61000-6-4, IEC/EN/BS 60947-1, IEC/EN/BS 60947-6-1, UL508 and CSA C22.2 n° 14.



ATP...

Order code	Operat- ing current AC1	Power (400V)	Dimensions (HxWxD)
	[A]	[kVA]	[mm (in)]
Auxiliary supply 230VAC, with four-pole contactors versions.			
ATP0045T4A230C600A	45	31	500x400x200 (19.68x15.75x7.87")
ATP0060T4A230C600A	60	42	500x400x200 (19.68x15.75x7.87")
ATP0080T4A230C600A	80	55	500x400x200 (19.68x15.75x7.87")
ATP0100T4A230C600A	100	69	500x400x200 (19.68x15.75x7.87")
ATP0125T4A230C600A	125	87	600x400x250 (23.62x15.75x9.84")
ATP0160T4A230C600A	160	111	600x400x250 (23.62x15.75x9.84")

General characteristics

The enclosed automatic transfer switches ATP series are provided in metallic enclosure IP65, complete with automatic transfer switch controller type ATL600, four-pole contactors BF series, dual power supply module type ATLDPS1 and miniature circuit breakers (MCB) type P1MB for the protection of the measuring lines.

They are used for the automatic or manual switching of the load between two lines ("MAIN LINE" and "SECONDARY LINE").

They are available in versions from 45 to 160A in four-pole configuration.

CONTROL FUNCTIONS OF THE LINES

- Phase sequence and phase loss
- Minimum and maximum voltage
- Voltage asymmetry
- Minimum and maximum frequency

Operational characteristics

- Power supply:
 - Auxiliary supply voltage: 230VAC (taken from the input lines)
- Voltage measurement inputs:
 - Rated voltage U_e : 100...480VAC (L-L)
 - Measuring range: 50...576VAC (L-L)
 - Frequency range: 45...66Hz
- 6 programmable digital inputs
- 7 programmable relay outputs:
 - 6 each with 1 normally open contact (NO-SPST) rated 8A 250VAC
 - 1 with 1 changeover contact (NO/NC - SPDT) rated 8A 250VAC
- Enclosure:
 - Metallic enclosure
 - Flanges for cable entries in the top and bottom sides
 - PVC locking system with double-comb tool insert
 - Opening with left hinges
 - IEC degree of protection: IP65.

Certifications and compliance

Certification obtained: EAC.

Compliant with standards: IEC/EN/BS 61439-2.

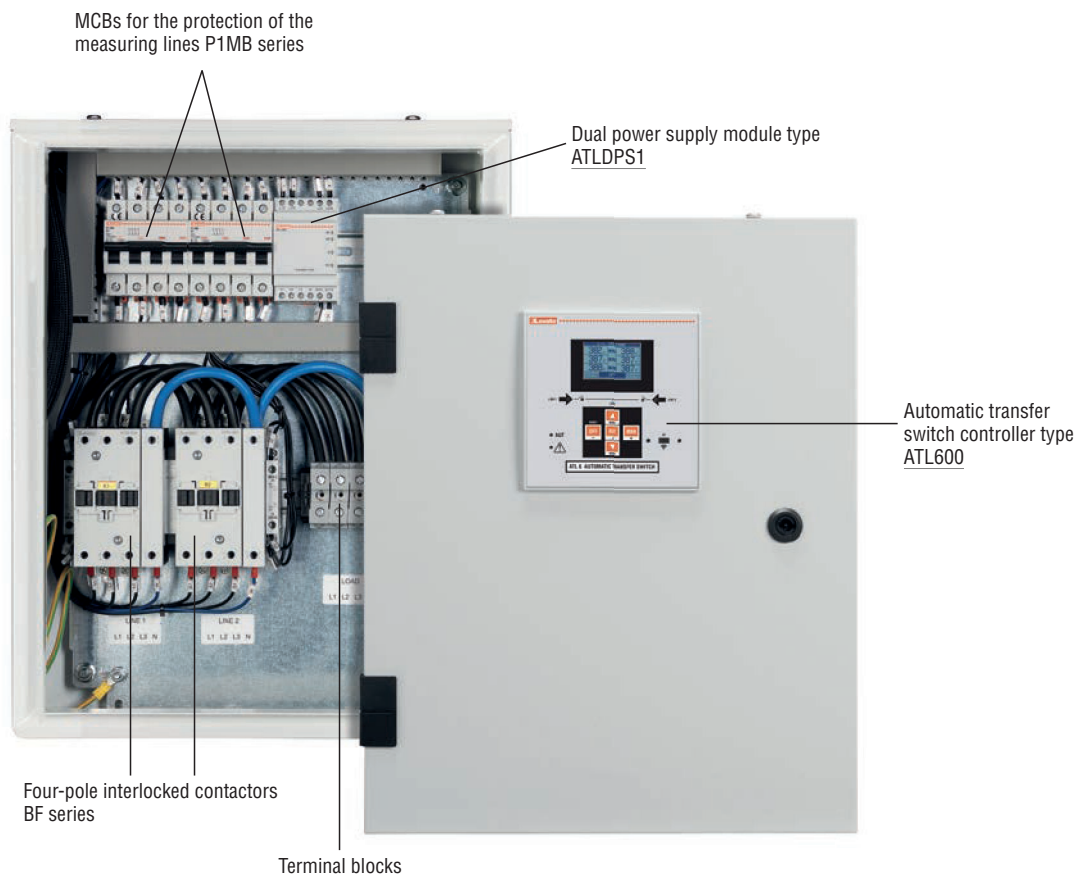

Dual power supply module



ATLDPS1

Order code	Description	Qty per pkg	Wt
		n°	[kg]
ATLDPS1	For controlling and selecting supply for motorised circuit breakers and changeover switches 110...230VAC configurable	1	0.300

	110VAC		230VAC	
	MIN	MAX	MIN	MAX
Line absent	< 88V	> 152V	< 176V	> 288V
Line present	< 92V	> 144V	< 185V	> 273V

Using the thresholds above **ATLDPS1** outputs one of the power supplies available according to the logic shown in the table:

Status Line 1	LED Line 1	Status Line 2	LED Line 2	Output	LED Output	ATLDPS1	Alarm contact	LED Fault
OK	ON	<MIN OR >MAX	OFF	ON - from line 1	ON	ON - OK	Closed	OFF
OK	ON	OK	ON	ON - from line 1	ON	ON - OK	Closed	OFF
<MIN OR >MAX	OFF	OK	ON	ON - from line 2	ON	ON - OK	Closed	OFF
<MIN >MAX	OFF	<MIN >MAX	OFF	OFF	OFF	OFF	Open	OFF
<MIN OR >MAX	OFF	<MIN OR >MAX	OFF	OFF	OFF	ON	Open	ON
>MIN	ON	OK	ON	OFF	OFF	ON - Fault Internal relays	Open	ON
<MIN OR >MAX	OFF	<MIN OR >MAX	OFF	OFF	OFF	ON - Fault Internal relays	Open	ON
>MIN	ON	>MIN	ON	OFF	OFF	ON - Fault Internal relays	Open	ON

General characteristics

ATLDPS1 is capable of measuring and controlling voltages at its inputs selecting the most ideal to connect to the output. It is suitable to supply motorised circuit breakers and changeover switches in automatic switching systems of 2 three-phase supply lines.

The two voltage inputs of the module are independent and insulated; each is capable of supplying the internal measuring circuit managed by the microcontroller. It reduces the number of components and improves installation safety.

Main **ATLDPS1** features include:

- Voltage value selectable via bypass terminals
- Minimum and maximum voltage tripping thresholds
- 2 single-phase L+N inputs
- 1 single-phase L+N output
- L1 priority line
- Use with motorised control units powered at 110VAC or 230VAC
- Output voltage monitoring
- Internal relay self-diagnosis
- Indicating LEDs for abnormal conditions and status of inputs and outputs.

Operational characteristics

- Rated supply voltage: 110...230VAC configurable
- Frequency: 50/60Hz
- Input voltage range: 80...300VAC
- Voltage tripping thresholds min / max: 80% and 120% of preset value
- 2 line inputs L1-L2: Single-phase, between phase and neutral
- Current output: 4A max.
- Priority line: L1 when both input values are within limits
- Fixed delay time between line switching: 0.5s
- 4 status indication LEDs for voltage of each line within limits, voltage present at output, relay output anomaly
- Mounting: 35mm DIN rail (IEC/EN/BS 60715) or screw-type by means of removable clips
- Modular housing, 3 module
- IEC degree of protection: IP40 on front; IP20 at rear.

Certifications and compliance

Certifications obtained: cULus, EAC, RCM, LOVAG. Compliant with standards: IEC/EN/BS 61010-2-030, IEC/EN/BS 61010-2, IEC/EN/BS 61000-6-2, IEC/EN/BS 61000-6-4, IEC/EN/BS 60947-1, IEC/EN/BS 60947-6-1, UL508 and C22.2 n° 14.

Communication devices



CX01



CX02



CX03

Order code	Description	Qty per pkg	Wt
		n°	[kg]
CX01	USB/optical device with PC ↔ ATL600/610/800/900 with optical port for programming data download, diagnostics and firmware upgrade	1	0.090
CX02	Wi-Fi device for connecting PC ↔ ATL600/610/800/900 with optical port for programming, data download, diagnostics and cloning	1	0.090
CX03	GSM penta-band antenna (850/900/1800/1900/2100MHz)	1	0.090

General characteristics

Communication devices for connection of LOVATO Electric products to personal computers, smartphones and tablets.

CX01

The USB/optical device, complete with cable, allows the connection of products compatible with PCs without having to disconnect the power supply from the electric panel. The PC identifies the connection as a standard USB.

CX02

By Wi-Fi connection, compatible LOVATO Electric products can be viewed on PCs, smartphones and tablets with no need for cabling.

CX03

Antenna compatible with major part of worldwide mobile networks thanks to the use of 850/900/1800/1900/2100MHz frequencies. Protection rating IP67. Fixing hole Ø10mm/3.94". Cable length 2.5mm/0.10".

For dimensions, wiring schemes and technical characteristics, refer to technical instructions in downloads section of local or global websites www.LovatoElectric.com or consult Technical support.

Software and accessories



EXP8001



51C4



EXCCON01



EXCM4G01

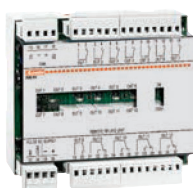

RGKRR

new

Order code	Description	Qty per pkg	Wt
		n°	[kg]
EXP8001	Protective seal IP65 for ATL500/600/601/610	1	0.150
For ATL610 - ATL800 - ATL900.			
51C2	Connection cable PC ↔ ATL610/800/900 with EXP1011, length 1.8m	1	0.090
51C4	Connection cable PC ↔ product RS232/RS485, length 1.8m	1	0.147
EXCCON01	RS485/Ethernet converter, 12...48VDC, including kit for DIN rail fixing	1	0.400
EXCM4G01	RS485 gateway/4G modem, 9...36VDC, including cable for programming	1	0.340
For ATL900.			
RGKRR	Remote unit for status and alarms, 12/24 VDC, 12 relay outputs, pulse input	1	0.420

Software

By using the **Xpress** software, the quick setup of the switch controllers can be carried out via PC, avoiding parameter programming errors.

The parameter programming of ATL600/610/800/900 controllers can also be PC saved and quickly uploaded into another device requiring the same programming. It permits the correct operation of the system to be checked through graphic and numerical display of the measurements and controller status.

Synergy and **Synergy** softwares provide for the supervision of the ATL600/610/800/900 transfer switch controllers.

This software has structures and applications based on MS SQL relational databases, and the data can be consulted using the most popular browsers.

It is a highly versatile system, simultaneously accessible to a large number of users/workstations via intranets, VPN or Internet.

See section 30 for details.

App for smartphone and tablet

The **Sam1** (Setup And Maintenance 1) application allows the user to program the controller, view alarm conditions, send commands, read measurements, download statistical data and events and send retrieved data by email. The connection is made by Wi-Fi with a smartphone or tablet using the CX02 dongle.

It is iOS and Android compatible.

For more details consult our Technical support.

For ATL500, ATL800 and ATL900, featuring built-in NFC technology, the **NFC** App LOVATO application is available for parameter programming, downloadable from Google Play Store and App Store.

EXCCON01

The EXCCON01 converter allows "Slave" devices connected on an RS485 network to interface with a "Master" featuring Ethernet port:

- Kit comprising MOXA NPORT5230 converter and DIN rail mounting accessory DK35
- Programming via web interface
- Power supply not included.

See section 31 for details.

EXCM4G01

The EXCM4G01 gateway allows "Slave" devices connected on an RS485 network to interface with a "Master" via 4G network. See section 31 for details.

RGKRR

It is an expansion unit for remote status and alarms. RGKRR can be connected at a maximum distance of 1000m/39.37" using the static output of the ATL900. RGKRR has 12 output relays, 7 normally open (2.5A 250VAC/C38) and 5 changeover contacts (5A 250VAC/B300).

See section 28 for details.

27 Automatic transfer switch controllers

Dimensions [mm (in)]

AUTOMATIC TRANSFER SWITCH CONTROLLERS

ATL100

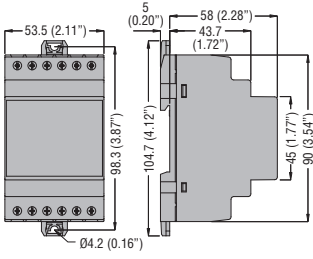

ATL500 - ATL600 - ATL601 - ATL610

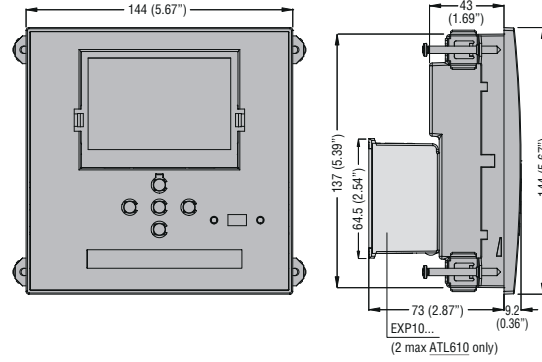

Cutout

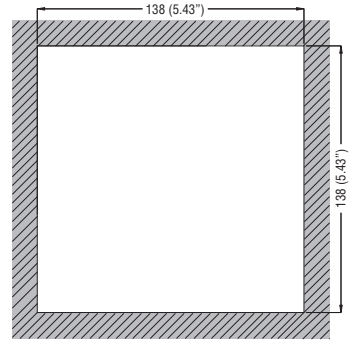

ATL800 - ATL900

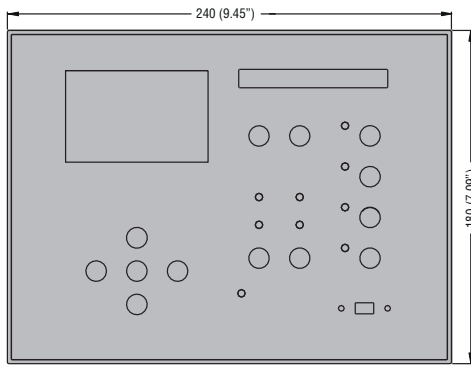

Cutout

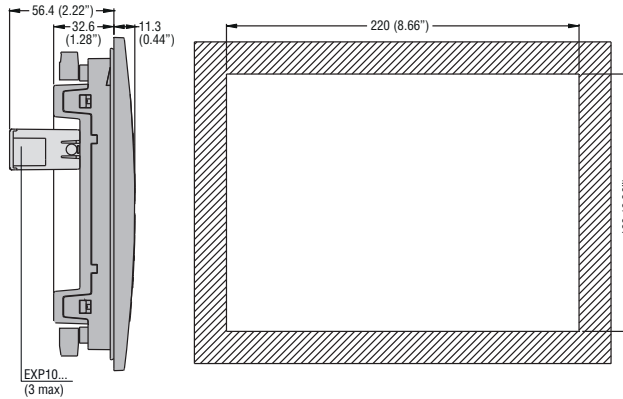

DUAL POWER SUPPLY MODULE

ATLDPS1

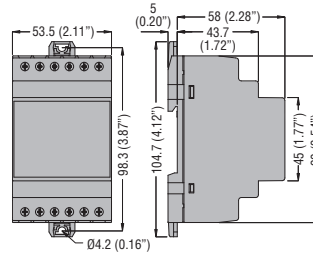

EXPANSION UNIT

RGKRR

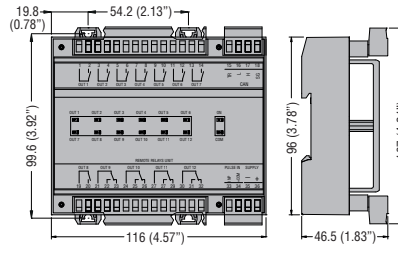

CONVERTER

EXCCON01

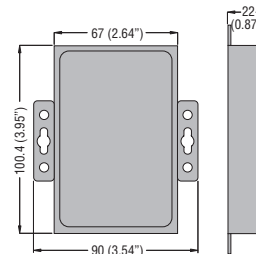

GATEWAY

EXCM4G01

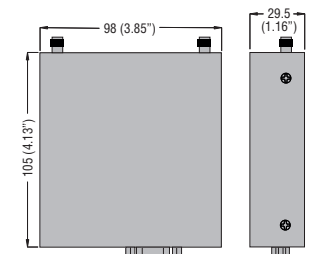

ENCLOSED AUTOMATIC TRANSFER SWITCHES ATS

ATP0045... - ATP0060... - ATP0080... - ATP0100...

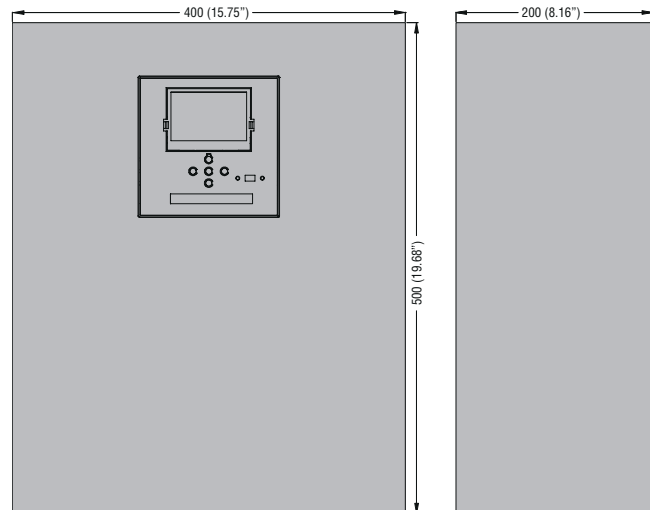

ATP0125... - ATP0160...

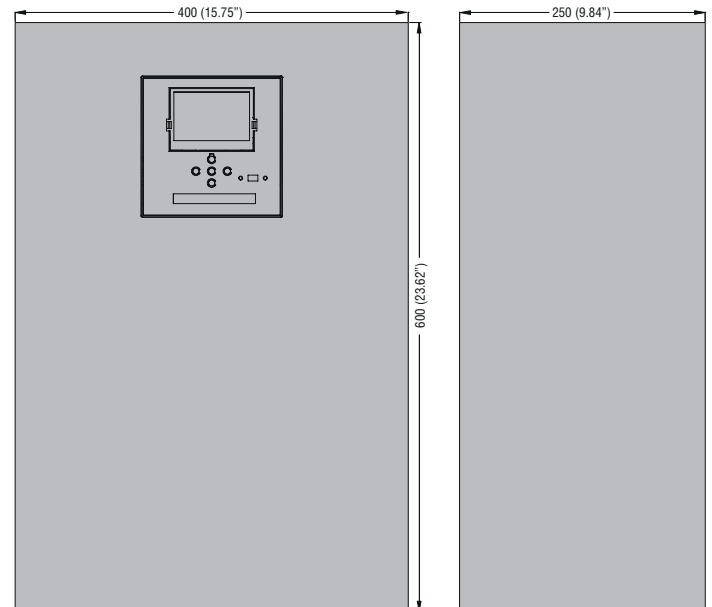

ATL100

Connection diagrams

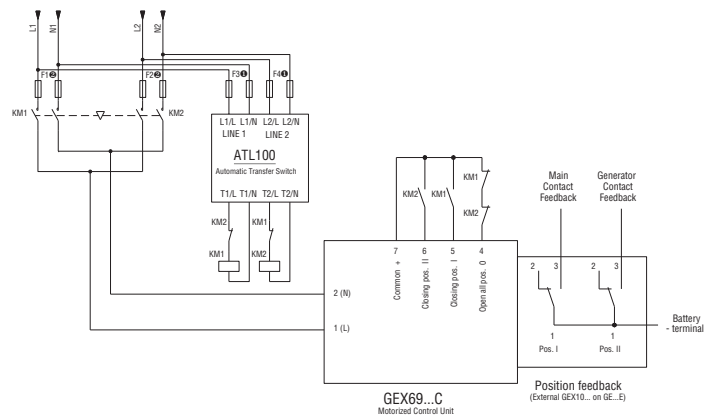
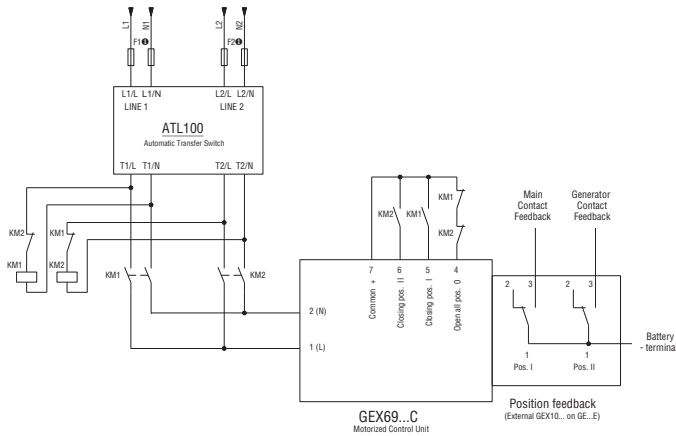
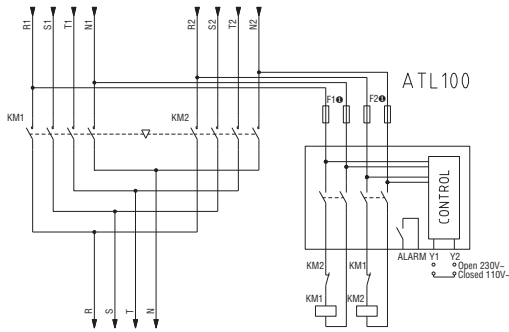

- ① 4A maximum fuses
- ② 1A maximum fuses

ATL500

Connection diagrams
Contactors control

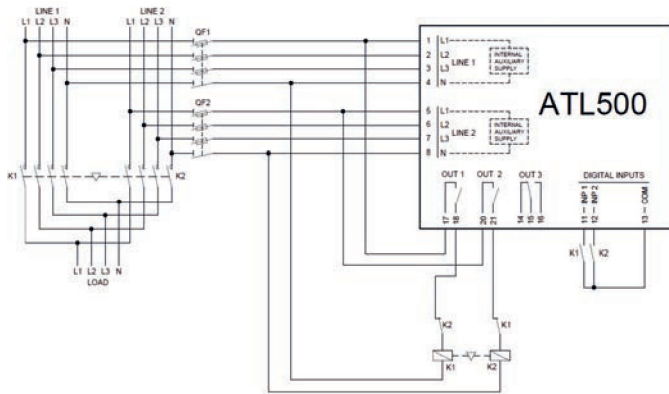

Connection diagrams
Motorised changeover switches control

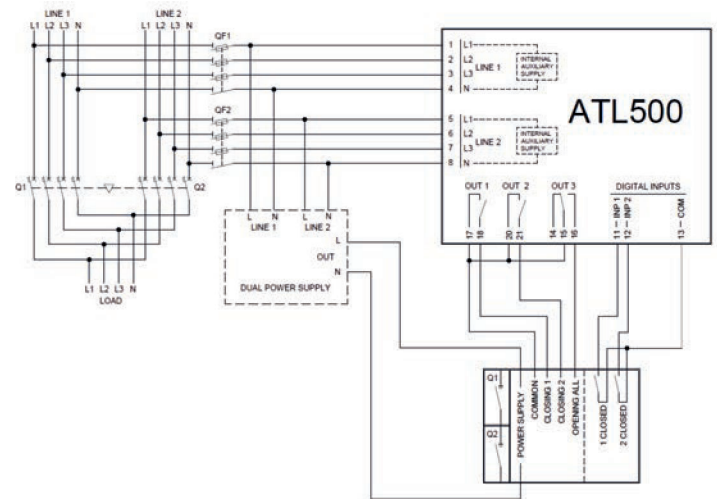

③ For the correct programming of inputs and outputs, consult the installation manuals available at www.LovatoElectric.com.

ATL600 - ATL601 - ATL610

Connection diagrams
Motorised breaker control

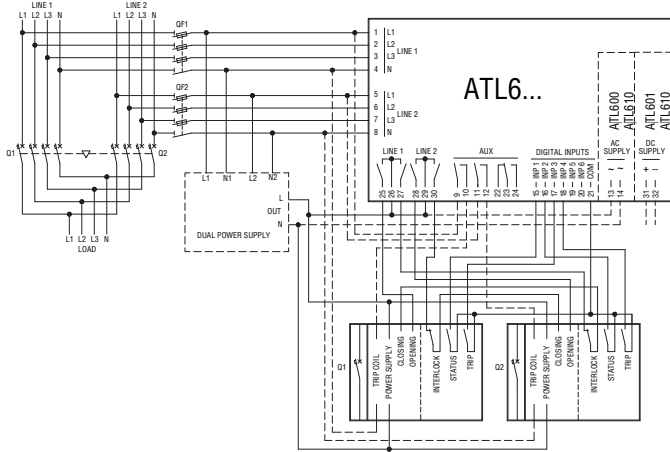

Connection diagrams
Motorised changeover switches control

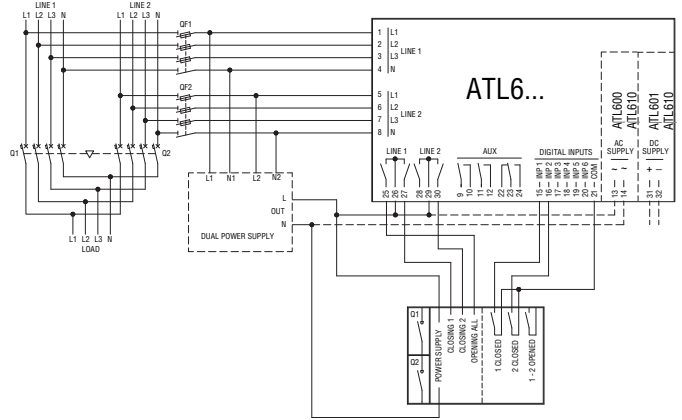

For the correct programming of inputs and outputs, consult the installation manuals available at www.LovatoElectric.com.

ATL800

Power connection diagrams
Two breakers

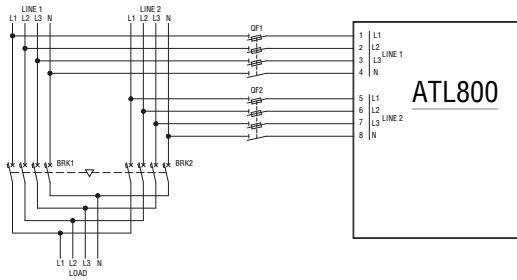

Power connection diagrams
Two breakers and a tie breaker

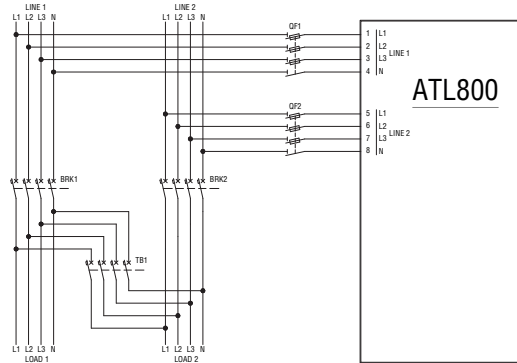

Control connection diagrams
Two breakers

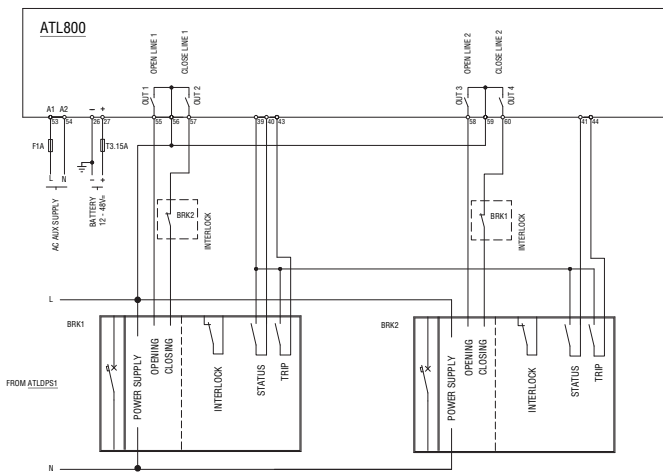

Control connection diagrams
Two breakers and a tie breaker

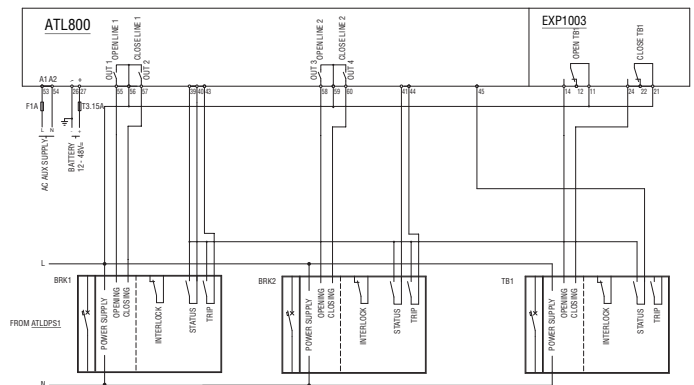

For the correct programming of inputs and outputs, consult the installation manuals available at www.LovatoElectric.com.

ATL900 ①

Power connection diagrams
Three breakers

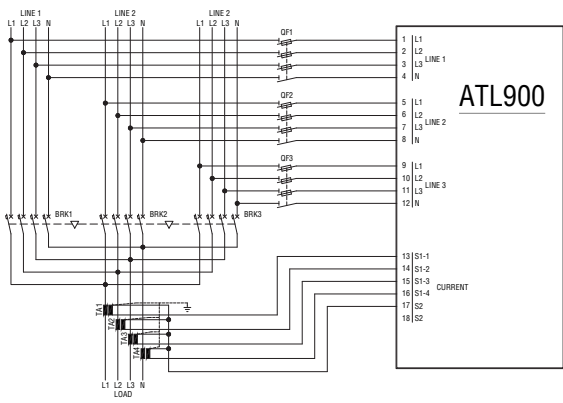

Power connection diagrams
Three breakers and two tie breakers

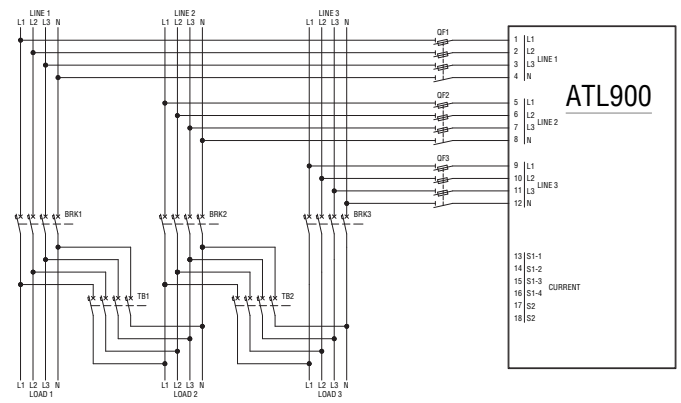

Control connection diagrams
Three breakers

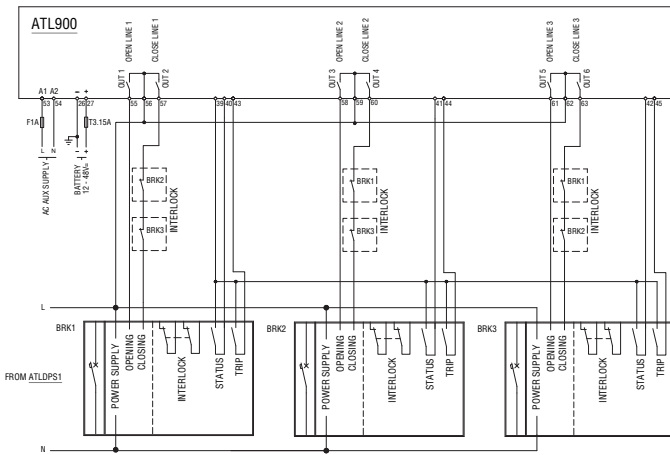

Control connection diagrams
Three breakers and two tie breakers

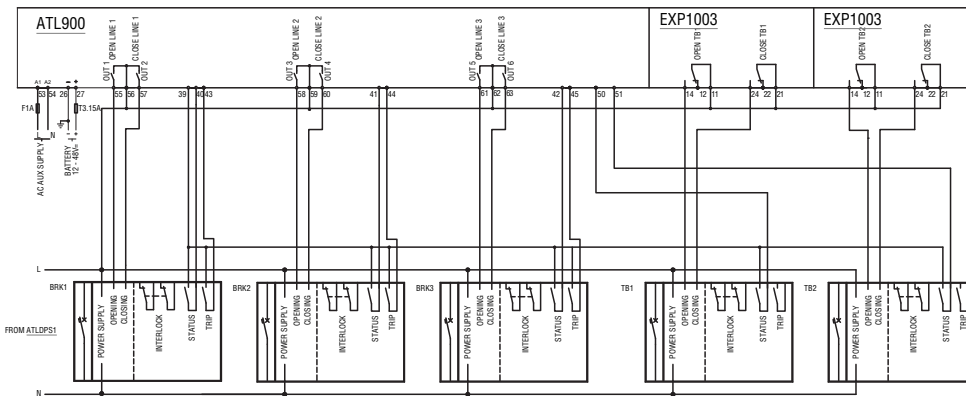

ATLDPS1 ①

Connection diagram

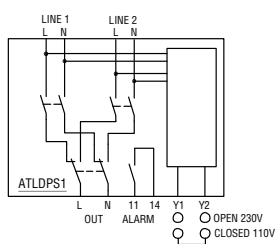

① For the correct programming of inputs and outputs, consult the installation manuals available at www.LovatoElectric.com.

TYPE	ATL100	ATL500	ATL600 - ATL601 - ATL610	ATL800	ATL900
AC POWER					
IEC rated supply voltage Us	110...230VAC	110...240VAC	100...240VAC (ATL600, ATL610)	100...240VAC	100...240VAC
Operating range	80...300VAC	90...300VAC	90...264VAC (ATL600, ATL610)	90...264VAC	90...264VAC
Frequency	45...66Hz	45...66Hz	45...66Hz	45...66Hz	45...66Hz
Immunity time for micro-breaking	—	≤200ms (110VAC) ≤400ms (220VAC)	≤50ms (110VAC) ≤250ms (220VAC)	≤40ms (110VAC) ≤200ms (220VAC)	≤40ms (110VAC) ≤200ms (220VAC)
Immunity time for micro-breaking (with EXP expansions)	—	—	≤25ms (110VAC) ≤120ms (220VAC)	≤20ms (110VAC) ≤100ms (220VAC)	≤20ms (110VAC) ≤100ms (220VAC)
DC POWER					
Rated battery voltage	—	—	12-24VDC (ATL601, ATL610)	12-24-48VDC	12-24-48VDC
Operating range	—	—	7.5...33VDC (ATL601, ATL610)	7.5...57.6VDC	7.5...57.6VDC
Maximum current consumption	—	—	230mA at 12VDC; 120mA at 24VDC	400mA at 12VAC; 220mA at 24VDC; 100mA at 48VDC	510mA at 12VAC; 260mA at 24VDC; 135mA at 48VDC
Maximum power consumption/dissipation	—	—	2.9W	4.8W	6.5W
VOLTMETER INPUTS					
Maximum rated voltage Ue	110...230VAC	415VAC L-L (240VAC L-N)	480VAC L-L (277VAC L-N)	600VAC L-L (346VAC L-N)	600VAC L-L (346VAC L-N)
Measuring range	80...300VAC	155...519VAC L-L (300VAC L-N)	50...576VAC L-L (333VAC L-N)	50...720VAC L-L (415VAC L-N)	50...720VAC L-L (415VAC L-N)
Frequency range	45...66Hz	45...66Hz	45...66Hz	45...66Hz	45...66Hz
Measurement method	True root mean square (TRMS)	True root mean square (TRMS)	True root mean square (TRMS)	True root mean square (TRMS)	True root mean square (TRMS)
Measuring input impedance	L-N >8MΩ	>0.5MΩ L-N, >1.0MΩ L-L	>0.5MΩ L-N, >1.0MΩ L-L	>0.55MΩ L-N, >1.10MΩ L-L	>0.55MΩ L-N, >1.10MΩ L-L
Wiring method	Single-phase and neutral	Single-phase, two-phase, three-phase line with neutral	Single-phase, two-phase, three-phase line with or without neutral and balanced three-phase		
AMMETER INPUTS					
Rated current Ie	—	—	—	—	1A~ or 5A~
Measuring range	—	—	—	—	for scale 5A: 0.02 - 6A~ for scale 1A: 0.02 - 1.2A~
Type of input	—	—	—	—	Shunt supplied by current transformer external (low voltage) 5A max.
Measurement type	—	—	—	—	True root mean square (TRMS)
Overload capacity	—	—	—	—	-20% Ie
Overload peak	—	—	—	—	50A for 1 second
Burden	—	—	—	—	<0.6VA
MEASUREMENT ACCURACY					
Mains and genset voltage	±0.25% f.s.	±0.25% f.s.	±0.25% f.s. ±1 digit	±0.25% f.s. ±1 digit	±0.25% f.s. ±1 digit
DIGITAL INPUTS					
Number of inputs	—	2	6	8	12
Type of input	—	Negative	Negative	Negative	Negative
Input current	—	<5mA	<8mA	<8mA	<8mA
Low input signal	—	≤2.6V	≤2.2V	≤2.2V	≤2.2V
High input signal	—	≥3.1V	≥3.4V	≥3.4V	≥3.4V
Input signal delay	—	≥50ms	≥50ms	≥50ms	≥50ms
CALENDAR CLOCK					
Backup reserve power	—	—	Backup capacitor (ATL610)	Backup capacitor	Backup capacitor
Operation without power voltage	—	—	5 min approx. (ATL610)	14 days approx.	14 days approx.
RELAY OUTPUTS					
Number of outputs	3	3	7	7	10
Configuration	- 2NO: AC1 - 4A 250VAC; 1.5A 250V~ AC15 - 1NO: AC1 - 3A 250VAC; DC1 - 3A 30VDC	- 2NO: AC1 - 8A 250VAC; AC15 - 1.5A 250VAC; - 1 changeover: AC1 - 8A 250VAC, DC1 - 8A 30VDC; AC15 - 1.5A 250VAC	- 6NO: AC1 - 8A 250VAC; AC15 - 1.5A 250VAC; B300 - 1 changeover: AC1 - 8A 250VAC, DC1 - 8A 30VDC; AC15 - 1.5A 250VAC, B300 30VDC1A Auxiliary service	- 2NO: AC1 - 12A 250VAC; AC15 - 1.5A 250VAC; B300 - 2NO: AC1 - 8A 250VAC; AC15 - 1.5A 250VAC; B300 - 3 changeover: AC1 - 8A 250VAC, DC1 - 8A 30VDC; AC15 - 1.5A 250VAC; B300 30VDC 1A Auxiliary service	- 3NO: AC1 - 12A 250VAC; AC15 - 1.5A 250VAC; B300 - 3NO: AC1 - 8A 250VAC; AC15 - 1.5A 250VAC; B300 - 4 changeover: AC1 - 8A 250VAC, DC1 - 8A 30VDC; AC15 - 1.5A 250VAC; B300 30VDC 1A Auxiliary service
Mechanical / electrical endurance	1x10 ⁷ / 1x10 ⁵ operations	1x10 ⁷ / 1x10 ⁵ operations	1x10 ⁷ / 1x10 ⁵ operations	1x10 ⁷ / 1x10 ⁵ operations	1x10 ⁷ / 1x10 ⁵ operations

TYPE	ATL100	ATL500	ATL600 - ATL601 - ATL610	ATL800	ATL900
STATIC OUTPUT					
Output type	—	—	—	—	NO
Operating voltage	—	—	—	—	10-30V
Maximum current	—	—	—	—	50mA
AMBIENT CONDITIONS					
Operating temperature	-30...+70°C				
Storage temperature	-30...+80°C				
Relative humidity	<80% (IEC/EN/BS 60068-2-78)				
Maximum pollution degree	2				
Overtoltage category	3				
Measurement category	III				
Climatic sequence	Z/ABDM (IEC/EN/BS 60068-2-61)				
Shock resistance	15g (IEC/EN/BS 60068-2-27)				
Vibration resistance	0.7g (IEC/EN/BS 60058-2-6)				
HOUSING					
Version	Modular housing 3 modules (DIN 43880)	Flush-mount			
Material	Polyamide RAL 7035	Polycarbonate			
IEC degree of protection	IP40 on front IP20 on terminals	IP40 on front IP65 with optional gasket IP20 on terminals		IP65 on front IP20 on terminals	
Weight	300g	580g	600g (ATL600 - ATL601) 680g (ATL610)	1000g	1090g
CERTIFICATIONS AND COMPLIANCE					
Certifications obtained	EAC	EAC, RCM	cULus, RCM (except ATL601), EAC, LOVAG (ATL610, ATL800, ATL900)		
Compliance with standards	IEC/EN/BS 61010-1, IEC/EN/BS 61010-2-030, IEC/EN/BS 61000-6-2, IEC/EN/BS 61000-6-4, IEC/EN/BS 60947-1, IEC/EN/BS 60947-6-1	IEC/EN/BS 61010-1, IEC/EN/BS 61010-2-030, IEC/EN/BS 61000-6-2, IEC/EN/BS 61000-6-3, IEC/EN/BS 60947-1, IEC/EN/BS 60947-6-1	IEC/EN/BS 61010-1, IEC/EN/BS 61010-2-030, IEC/EN/BS 61010-2, IEC/EN/BS 61000-6-2, IEC/EN/BS 61000-6-4, IEC/EN/BS 60947-1, IEC/EN/BS 60947-6-1, UL508 e CSA C22.2 n°14		

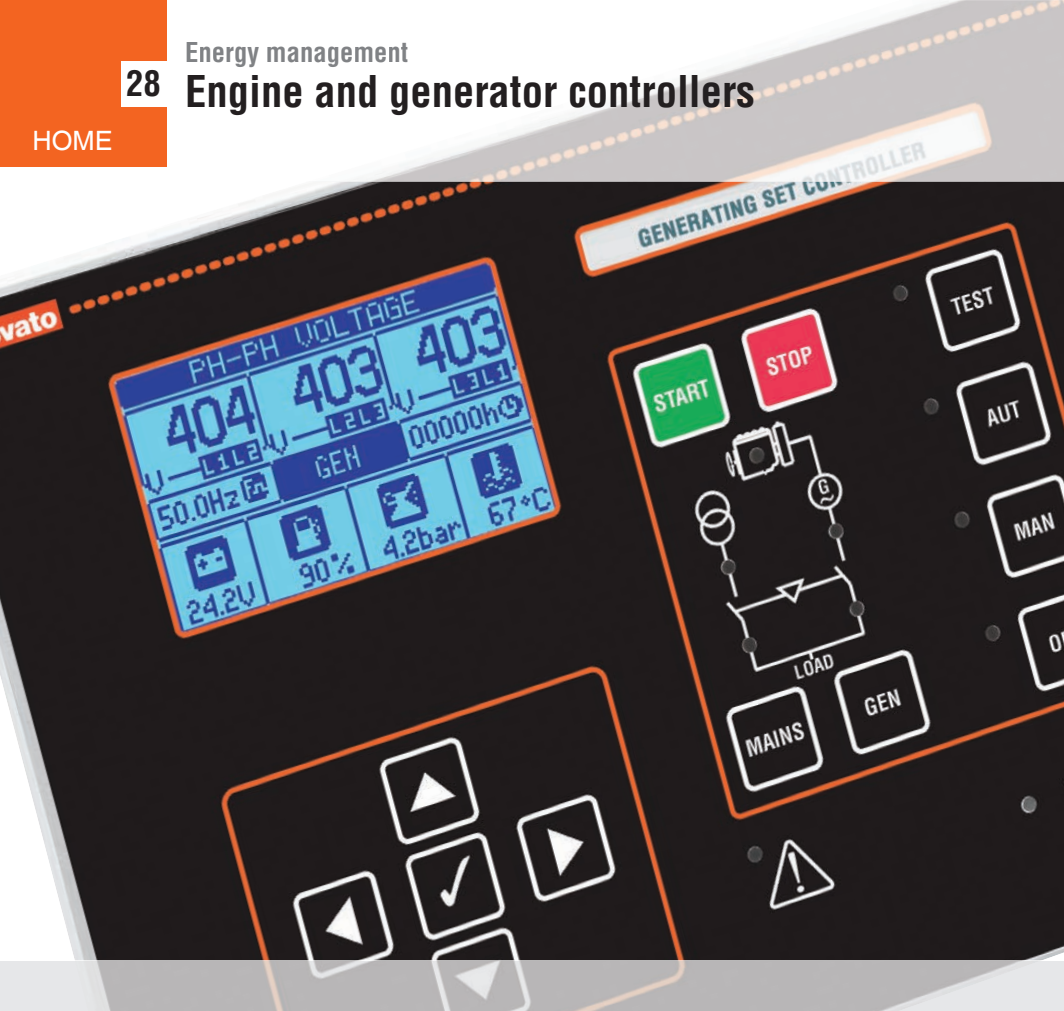

- Extensive selection of functions to satisfy all application requirements
- Power supply range 12-24VDC for each single product
- Totally programmable inputs, outputs and alarms
- RS232, RS485, USB, Ethernet communication interface
- Engine control by CANbus
- Setup and supervision software
- Modem control for sending alarm messages and emails.

Engine and generator controllers

Engine protection controllers	28 - 6
Stand alone gen-set controllers	28 - 7
Automatic mains failure (AMF) gen-set controllers	28 - 8
Paralleling controllers for mains-generator and generator-generator	28 - 9
Remote and alarm-status relay units	28 - 10
Communication devices and accessories	28 - 11
Software	28 - 12

Dimensions	28 - 13
-------------------------	----------------





Page 28-6

STAND ALONE GEN-SET CONTROLLERS

- Generator voltage and current control
- Engine protection
- Programmable inputs and outputs
- Programmable alarm properties.



Page 28-7

AUTOMATIC MAINS FAILURE (AMF) GEN-SET CONTROLLERS

- Automatic starting of generator and load switching to stand-by emergency source in case of mains failure
- Management in “open transition” for contactors, motorised circuit breakers and motorised changeover switches
- Engine protection
- Programmable inputs, outputs and alarms.



Page 28-8

PARALLELING CONTROLLERS FOR MAINS-GENERATOR AND GENERATOR-GENERATOR

- Mains-generator synchronising “closed transition”
- Mains-generator load sharing with source peak demand control
- Generator paralleling management (island mode with load sharing).



Page 28-9

REMOTE UNITS

- Remote viewing and control panels
- Remote annunciator for alarm and status indication
- Digital outputs for alarm and status condition remotely.



Page 28-11

COMMUNICATION DEVICES, ACCESSORIES AND SOFTWARE

- Communication interfaces
- Additional digital and analog inputs and outputs
- GPRS-GSM module
- Setup and supervision software
- APP.



STAND ALONE GEN-SET CONTROLLERS				
	RGK400SA RGK420SA	RGK600SA RGK601SA	RGK700SA	RGK800SA
Generator voltage control	L1-L2-L3-N	L1-L2-L3-N	L1-L2-L3-N	L1-L2-L3-N
Current control	L1	L1-L2-L3	L1-L2-L3	L1-L2-L3-N
Rated frequency	50/60Hz	50/60Hz	50/60Hz	50/60/400Hz
Digital inputs	n° 5 neg.+1 pos. (emergency)	4 neg.+1 pos. (emergency)	6 neg.+1 pos. (emergency)	8 neg.+1 pos. (emergency)
Digital outputs	n° 5 (SSR)	6 (SSR)	3 (Relay) + 4 (SSR)	3 (Relay)+6 (SSR)+1(SO)
Engine running inputs	"D+", Hz	"D+", Hz	"D+", "AC", Hz	"D+", "AC", Hz
Ohmic inputs for fuel-pressure-temperature (programmable as digital inputs)	1+2 (EXP1040)	●	●	●
Remote supervision	-	-	●	●
CANbus interface	-	RGK601SA	●	●
Rated battery voltage	12/24VDC	12/24VDC	12/24VDC	12/24VDC
Power supply range	7...33VDC	7...33VDC	7...33VDC	7...33VDC
Mains voltage control	-	-	-	-
Rated voltage range	100...480VAC	100...480VAC	30...600VAC	30...600VAC
VT programming	●	●	●	●
Rated input current	5A/1A	5A/1A	5A/1A	5A/1A
TRMS voltage measurement	●	●	●	●
TRMS current measurement	●	●	●	●
Display	LCD with icons and backlight	Graphic backlight LCD, 128x80 pixels	Graphic backlight LCD, 128x80 pixels	Graphic backlight LCD, 128x80 pixels
Engine running magnetic pick-up input	●	RGK600SA	●	●
Engine speed input	"W" or generator frequency or "Pick-up"	"W" or generator frequency or "Pick-up" (RGK600SA)	"W" or generator frequency or "Pick-up"	"W" or generator frequency or "Pick-up"
Auxiliary analog input	-	-	-	●
I/O expansion	1 x EXP1040	RGKRR	RGKRR	3 x EXP... + RGKRR
USB/Optical port on front	●	●	●	●
Wi-Fi port on front	●	●	●	●
USB port at rear	-	-	-	EXP1010
Ethernet port with Web server function	-	-	-	EXP1013
GPRS/GSM modem	-	-	-	EXP1015
RS232 serial port	-	-	●	EXP1011
RS485 serial port	-	-	-	●
Event logging	-	●	●	●
RTC (Real Time Clock)	-	-	-	●
Programmable Inputs/Outputs	●	●	●	●
PLC logic function	-	-	●	●
Alarms	●	●	●	●
User alarms	n° 2	4	8	8
Alarm property customising	●	●	●	●
Texts for alarms, events and parameters	●	●	●	●
Multilanguage (type)	n° 5 (GB - I - F - E - D)	5 (GB - I - F - P - E)Ⓜ	5 (GB - I - F - P - E)Ⓜ	5 (GB - I - F - P - E)Ⓜ
Upload languages	-	●	●	●
Load sharing	-	-	-	-
Generator paralleling	-	-	-	-
Mains-generator synchronising (closed transition)	-	-	-	-
IEC front degree of protection	IP40, IP65 with optional gasket sealⓂ	IP40, IP65 with optional gasket seal	IP65	IP65
Certifications	cULus, EAC	cULus, EAC	cULus, EAC	cULus, EAC

① Frequency only.

Ⓜ For RGK400SA only.

Ⓜ Controller uploading of other multilanguage sets.



	AUTOMATIC MAINS FAILURE (AMF) GEN-SET CONTROLLERS				PARALLELING / LOAD SHARING CONTROLLERS	
	RGK600 RGK601 RGK610	RGK700	RGK750	RGK800	RGK900	RGK900SA
Generator voltage control	L1-L2-L3-N	L1-L2-L3-N	L1-L2-L3-N	L1-L2-L3-N	L1-L2-L3-N	L1-L2-L3-N
Current control	L1-L2-L3	L1-L2-L3	L1-L2-L3	L1-L2-L3-N	L1-L2-L3-N	L1-L2-L3-N
Rated frequency	50/60Hz	50/60Hz	50/60Hz	50/60/400Hz	50/60/400Hz	50/60/400Hz
Digital inputs	n° 4 neg.+1 pos. (emergency)	6 neg.+1 pos. (emergency)	8 neg.+1 pos. (emergency)	8 neg.+1 pos. (emergency)	12 neg.+1 pos. (emergency)	12 neg.+1 pos. (emergency)
Digital outputs	n° 6 (SSR)	3 (Relay) + 4 (SSR)	3 (Relay)+6 (SSR) +1(SO)	3 (Relay)+6 (SSR) +1(SO)	3 (Relay)+6 (SSR) +1(SO)	3 (Relay)+6 (SSR) +1(SO)
Engine running inputs	"D+", Hz	"D+", "AC", Hz	"D+", "AC", Hz	"D+", "AC", Hz	"D+", "AC", Hz	"D+", "AC", Hz
Ohmic inputs for fuel-pressure-temperature	●	●	●	●	●	●
Remote supervision	RGK610	●	●	●	●	●
CANbus interface	RGK601	●	●	●	●	●
Rated battery voltage	12/24VDC	12/24VDC	12/24VDC	12/24VDC	12/24VDC	12/24VDC
Power supply range	7...33VDC	7...33VDC	7...33VDC	7...33VDC	7...36VDC	7...36VDC
Mains voltage control	L1-L2-L3-N	L1-L2-L3-N	L1-L2-L3-N	L1-L2-L3-N	L1-L2-L3-N	-
Rated voltage range	100...480VAC	30...600VAC	100...480VAC	30...600VAC	30...600VAC	30...600VAC
VT programming	●	●	●	●	●	●
Rated input current	5A/1A	5A/1A	5A/1A	5A/1A	5A/1A	5A/1A
TRMS voltage measurement	●	●	●	●	●	●
TRMS current measurement	●	●	●	●	●	●
Display	Graphic backlight LCD, 128x80 pixels	Graphic backlight LCD, 128x80 pixels	Graphic backlight LCD, 128x80 pixels	Graphic backlight LCD, 128x80 pixels	Graphic backlight LCD, 128x112 pixels	Graphic backlight LCD, 128x112 pixels
Engine running magnetic pick-up input	RGK600/RGK610	●	●	●	●	●
Engine speed input	"W"/"Pick-up" (RGK600/RGK610) or generator frequency	"W" or generator frequency or "Pick-up"	"W" or generator frequency or "Pick-up"	"W" or generator frequency or "Pick-up"	"W" or generator frequency or "Pick-up"	"W" or generator frequency or "Pick-up"
Auxiliary analog input	-	-	●	●	●	●
I/O expansion	1 x EXP... + RGKRR	RGKRR	2 x EXP... + RGKRR	3 x EXP... + RGKRR	4 x EXP... + RGKRR	4 x EXP... + RGKRR
USB/Optical port on front	●	●	●	●	●	●
Wi-Fi port on front	●	●	●	●	●	●
USB port at rear	EXP1010 (RGK610)	-	EXP1010	EXP1010	EXP1010	EXP1010
Ethernet port with Web server function	-	-	EXP1013	EXP1013	EXP1013	EXP1013
GPRS/GSM modem	-	-	EXP1015	EXP1015	EXP1015	EXP1015
RS232 serial port	EXP1011 (RGK610)	●	EXP1011	EXP1011	EXP1011	EXP1011
RS485 serial port	EXP1012 (RGK610)	-	EXP1012	●	●	●
Event logging	●	●	●	●	●	●
RTC (Real Time Clock)	-	-	●	●	●	●
Programmable Inputs/Outputs	●	●	●	●	●	●
PLC logic function	-	●	●	●	●	●
Alarms	●	●	●	●	●	●
User alarms	n° 4	8	8	8	16	16
Alarm property customising	●	●	●	●	●	●
Texts for alarms, events and parameters	●	●	●	●	●	●
Multilanguage (type)	n° 5 (GB - I - F - P - E)Ⓜ	5 (GB - I - F - P - E)Ⓜ	5 (GB - I - F - P - E)Ⓜ	5 (GB - I - F - P - E)Ⓜ	5 (GB - I - F - P - E)Ⓜ	5 (GB - I - F - P - E)Ⓜ
Upload languages	-	●	●	●	●	●
Load sharing	-	-	-	-	●	●
Generator paralleling	-	-	-	-	-	●
Mains-generator synchronising (closed transition)	-	-	-	-	●	-
IEC front degree of protection	IP40, IP65 with optional gasket seal	IP65	IP65	IP65	IP65	IP65
Certifications	cULus, EAC	cULus, EAC	cULus, EAC	cULus, EAC	cULus, EAC	cULus, EAC

A SUPERIOR CLASS!



● **CUSTOMISING OPTION**

There is a customising slot available on the front to show controller brand name, logo, trademark, part number, brief indication or wording, etc.

● **PROGRAMMING OPTICAL PORT**

The optical port on the panel front, using a standard USB or Wi-Fi point, allows communication with a PC, smartphone and tablet, to carry out programming, diagnostics and data download, without removing power to the electric panel.

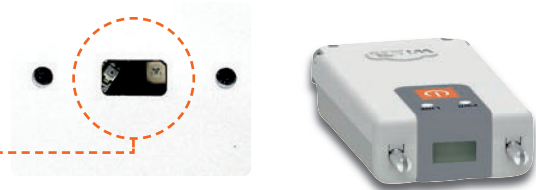

● **COMPACT SIZE**

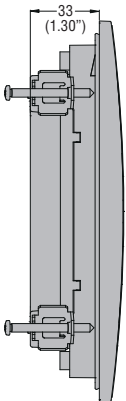

RGK700
RGK800
RGK900

Slim frame profile and reduced total depth simplify installation of the controllers in very compact electric panels.

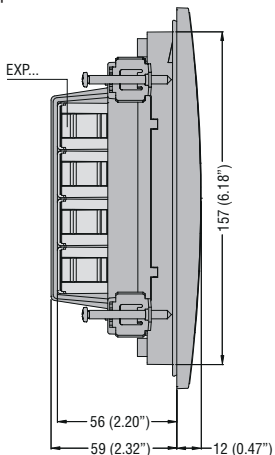

RGK800
RGK900

● **IP65 DEGREE OF PROTECTION**

The controller front and the internal display frame seal have been designed to warrant an **IP65** protection degree. This with the **UV film** also allow outdoor installation.



● **INSTALLATION**

The fixing with **metal screws** guarantees excellent adhesion over time.



● **CABLING AND EXPANSION MODULE FIXING SYSTEM**

The controller rear has 4 fitting slots to secure cables connected to the terminals with cable ties, in an orderly way inside the electric panel. In addition, a plastic retainer is supplied as standard to keep the expansion modules in place when installed in applications with strong vibrations.

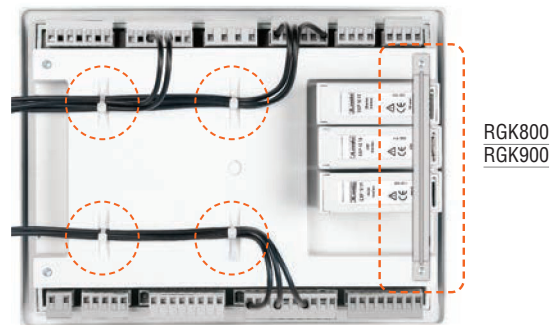

● **EXPANDABILITY**

Basic RGK750, RGK800 and RGK900 controller functions can be easily extended using up to 4 EXP series expansion modules:

- Digital and analog inputs and outputs
- Opto-isolated static outputs
- Relay outputs
- Opto-isolated RS232 interface
- Opto-isolated RS485 interface
- Opto-isolated Ethernet interface
- GPRS/GSM modem.



RGK750 (2 modules)
RGK800 (3 modules)
RGK900 (4 modules)



EXPANDABILITY

An extensive selection of modules is available to increase the controller functionality.

GPRS/GSM MODEM

Among the expansion modules, there is a GPRS/GSM modem, automatically configured by the genset controller.

MAINTENANCE

Maintenance supervision at programmed intervals.

STREAMLINE DESIGN

The controller has an ergonomic design and, at the same time, particular care has been given to details.

GPRS/GSM MODEM



Once a data-enabled SIM card is inserted, RGK750 - RGK800 - RGK900 controllers can send SMS with alarm and event conditions as well as the latest logged events to a FTP server.

CANBUS COMMUNICATION PORT

Most models are standard equipped with CAN-J1939 communication port.

PLC FUNCTION

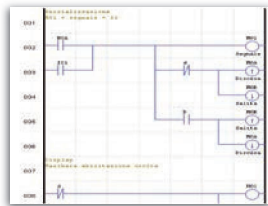

Capability to combine together internal status of controllers with signals incoming from the field to activate outputs and generate alarms.

LOAD MANAGEMENT

There are different methods of controlling the load conditions; each controller has special parameters functions as follows:

- RGK700 - RGK750 - RGK800 types: load shedding and dummy load modes
- RGK900 types: base-load and peak shaving modes.

PARALLELING

RGK900 and RGK900SA controllers can control the switching between the mains and generators without having to switch off the power supply to the load. In addition, they can control the paralleling connection of two or more generators sharing in this way the load on more than one source. The RGK900MC can control and synchronise mains parallel operation with a power bus composed by a series of generating sets.

REMOTE UNITS

Remote display panels



There are "mirror" display units available to remotely operate as if in front of the generating set.

Remote annunciator



A remote display can view alarm conditions and can be operated for silencing them.

Alarm-state relay unit

The relay unit allows to transmit, on voltage-free contacts, the status and alarms of RGK... controllers.



SUPERVISION SOFTWARE

Synergy is web-based and provides for an easy and efficient way to monitor and control electrical installations as well as field equipment.

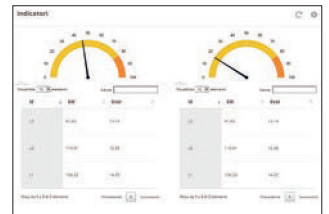

It is a server-multiclient system based on MS SQL RDBMS with web-browser interface. Simultaneous management of different communication channels with independent configuration (protocols, speed rate, RS232, RS485, Ethernet, modem) is possible. Live page view, data log tables, charts and alarms are available.

CLOUD SOLUTION

The supervision software is ready as Synergy^{Cloud} solution as well, so that the user does not have to install any package on its own servers.

CONFIGURATION AND REMOTE CONTROL SOFTWARE

Xpress is a parameter configuration and remote monitoring software shared by the entire latest generation of RGK gen-set controllers with communication port.

Stand alone gen-set controllers



RGK400SA



RGK420SA



Order code	Description	Qty per pkg	Wt [kg]
RGK400SA	12/24VDC, icon LCD display	1	0.410
RGK420SA	12/24VDC, icon LCD display, built-in 3 position key switch	1	0.430



The app can be downloaded from Google Play Store and App Store.



Order code	Description
ACCESSORIES FOR RGK4...SA	
EXP8005	IP65 housing gasket
EXPANSION MODULES FOR RGK4...SA Inputs and outputs.	
EXP1040	2 digital/resistive inputs, 2 static outputs
EXP1043T	4 digital input and 2 static outputs, PCB tropicalized
Communications interfaces.	
EXP1010	Opto-isolated USB interface
EXP1011	Opto-isolated RS232 interface
EXP1012	Opto-isolated RS485 interface
EXP1013	Ethernet interface
EXP1015	GPRS/GSM modem



EXP10...

STAND ALONE APPLICATION

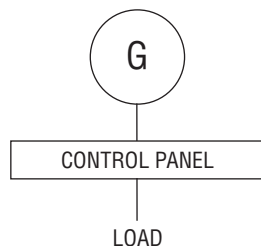

General characteristics for RGK400SA - RGK420SA

- Key with 3 positions (OFF, local start, remote start), removable in OFF and remote start position (for RGK420SA)
- Power supply: 7...33VDC
- VAC inputs: Generator L1-L2-L3-N
- Single, two and three phase voltage control
- Rated measurement voltage range: 100...480VLL (3PH+N)
- Programmable VT ratio
- Frequency measurement range: 45...65Hz
- Current input: 1PH, /5A or /1A
- Display: LCD with icons (52x35mm/2.05x1.38")
- Programming port: IR with support of CX01 (USB) and CX02 (Wi-Fi) dongles
- NFC technology for parameter setup
- Powersave mode
- Inputs: 5 negative + 1 positive for emergency
- Outputs: 5 positive, 2A, protected
- Common pin dedicated to EV and START outputs to be used with emergency push button
- Engine running detection: "D+", Hz
- Engine speed inputs: "W" or Magnetic "Pick-up"
- 1 analog ohmic input for oil pressure, engine temperature or fuel level control
- Alarm and parameter text in 5 languages
- Customisable alarm text (2 alarms)
- Operating temperature: -30...+60°C
- Parameter configuration by NFC technology with **NFC** App freely downloadable from Google Play Store and App Store
- Compatible with **Xpress** software.

Certification and compliance

Certifications obtained: IEC/BS 61010-1, IEC/BS 61010-2-030, IEC/BS 61000-6-2, IEC/BS 61000-6-4, UL508, CSA C22.2 n. 14.

Stand alone gen-set controllers



RGK600SA - RGK601SA



RGK700SA - RGK800SA



EXP10...

STAND ALONE APPLICATION

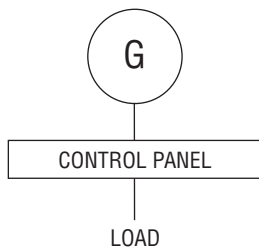

Order code	Description	Qty per pkg	Wt [kg]
RGK600SA	12/24VDC, graphic LCD display, w/Pick-up speed input	1	0.540
RGK601SA	12/24VDC, graphic LCD display, CANbus port	1	0.530
RGK700SA	12/24VDC, graphic LCD display, RS232 serial port, CANbus port	1	0.900
RGK800SA	12/24VDC, graphic LCD display, RS485 serial port, CANbus port. Expandable with EXP... modules	1	0.980

Programmable functions and properties

Charact.	RGK6...SA	RGK700SA	RGK800SA
Inputs	4	6	8
Relay outputs	-	3	3
Protected static outputs	6	4	7
Resistive/Digital inputs	3	3	4

Order code	Description
------------	-------------

ACCESSORIES FOR RGK600SA AND RGK601SA

EXP8001 IP65 housing gasket

EXPANSION MODULES FOR RGK800SA

Inputs and outputs.

EXP1041 2 thermocouple inputs, 2 static outputs

EXP1042T 6 digital inputs, PCB tropicalized

EXP1043T 4 digital input and 2 static outputs, PCB tropicalized

Inputs and outputs.

EXP1000 4 opto-isolated digital inputs

EXP1001 4 opto-isolated static outputs

EXP1002 2 digital inputs and 2 static outputs, opto-isolated

EXP1003 2 relay outputs rated 5A 250VAC

EXP1004 2 opto-isolated analog inputs 0/4-20mA or PT100 or 0-10V or 0...±5V

EXP1005 2 opto-isolated analog outputs 0/4-20mA or 0-10V or 0...±5V

EXP1008 2 opto-isolated digital inputs and 2 relay outputs rated 5A 250VAC

Communications interfaces.

EXP1010 Opto-isolated USB interface

EXP1011 Opto-isolated RS232 interface

EXP1012 Opto-isolated RS485 interface

EXP1013 Ethernet interface

EXP1015 GPRS/GSM modem

General characteristics for RGK600SA - RGK601SA - RGK700SA - RGK800SA

- Power supply: 7...33VDC
- VAC inputs: Generator L1-L2-L3-N
- Single, two and three phase voltage control
- Rated measurement voltage range:
 - 100...480VAC for RGK600SA and RGK601SA
 - 30...600VAC for RGK700SA and RGK800SA
- Programmable VT ratio
- Frequency measurement range: 45...65Hz
- Current input: 3PH, /5A or /1A
- Graphic LCD: 128x80 pixels with backlight
- Programming port: IR with support of CX01 (USB) and CX02 (Wi-Fi) dongles
- Common pin dedicated to EV and START outputs to be used with emergency push button
- Engine running detection: "D+", Hz
- Engine speed inputs: "W" or Magnetic "Pick-up" (RGK601SA excluded)
- 1 CANbus-J1939 port (RGK600SA excluded)
- 3 analog ohmic inputs for oil pressure, engine temperature and fuel level control
- 1 built-in alarm remote port
- Non-volatile memory for event storage
- Alarm, event and parameter text in 5 languages
- Customisable alarm text (8 alarms)
- Operating temperature: -30...+70°C
- Modbus-RTU and Modbus-ASCII protocols
- Compatible with Synergy, Synergy_{com} and Xpress software.

For RGK700SA - RGK800SA only

- PLC logic for inputs, outputs and internal status
- 1 communication port: RS232 for RGK700SA; RS485 for RGK800SA
- Degree of protection: IEC IP65 on front; suitable for use with UL/CSA Type 4X outdoor enclosure installation.

For RGK800SA only

- Neutral current measurement range: 0.050...6A or 0.050...1.2A
- 400Hz frequency support
- 1 programmable analog input
- Modbus-TCP communication protocol
- Current leakage control towards earth/ground
- Clock-calendar (RTC)

Certification and compliance

Certifications obtained: UL Listed, for USA and Canada (cULus - File E93601), as Auxiliary Devices - Generator controllers; EAC. Compliant with standards for RGK600/601: IEC/BS 61010-1, IEC/BS 61010-2-030, IEC/BS 61000-6-2, IEC/BS 61000-6-3, UL508, CSA C22.2 n. 14.

Compliant with standards for RGK700 and RGK800: IEC/BS 61010-1, IEC/BS 61000-6-2, IEC/BS 61000-6-3, UL508, CSA C22.2 n. 14.

Synergy, Synergy_{com}, and Xpress software

See Section 30.

EXP series expansion modules

See Section 31, page 2.

Automatic mains failure (AMF) gen-set controllers



RGK600 - RGK601 - RGK610



RGK700 - RGK800



RGK750



EXP10...

AMF (AUTOMATIC MAINS FAILURE) APPLICATION

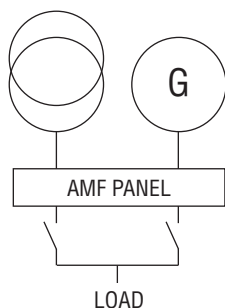

Order code	Description	Qty per pkg	Wt [kg]
		n°	
RGK600	W/Pick-up speed input	1	0.540
RGK601	CANbus port	1	0.540
RGK610	W/Pick-up speed input, expandable with EXP... modules	1	0.600
RGK700	RS232 serial port, CANbus port	1	0.880
RGK750	CANbus port, expandable with EXP... modules	1	0.960
RGK800	RS485 serial port, CANbus port, expandable with EXP... modules,	1	0.960

Programmable functions and properties

Characteristic	RGK600 RGK601 RGK610	RGK700	RGK750	RGK800
Inputs	4	6	8	8
Relay outputs	–	3	3	3
Protected static outputs	6	4	7	7
Resistive/Digital inputs	3	3	3	4

Order code	Description
ACCESSORY FOR RGK600, RGK601 AND RGK610	

EXP8001 | IP65 housing gasket

EXPANSION MODULES FOR RGK610, RGK750 AND RGK800
Communications interfaces.

EXP1010 | Opto-isolated USB interface

EXP1011 | Opto-isolated RS232 interface

EXP1012 | Opto-isolated RS485 interface

Inputs and outputs.

EXP1042T | 6 digital inputs, PCB tropicalized

EXP1043T | 4 digital input and 2 static outputs, PCB tropicalized

EXPANSION MODULES FOR RGK750

Inputs and outputs.

EXP1000 | 4 opto-isolated digital inputs

EXP1001 | 4 opto-isolated static outputs

EXP1002 | 2 digital inputs and 2 static outputs, opto-isolated

EXP1003 | 2 relay outputs rated 5A 250VAC

EXP1008 | 2 opto-isolated digital inputs and 2 relay outputs rated 5A 250VAC

EXPANSION MODULES FOR RGK800

Inputs and outputs.

EXP1004 | 2 opto-isolated analog inputs 0/4-20mA or PT100 or 0-10V or 0...±5V

EXP1005 | 2 opto-isolated analog outputs 0/4-20mA or 0-10V or 0...±5V

EXP1040 | 2 digital/resistive inputs, 2 static outputs

EXP1041 | 2 thermocouple inputs, 2 static outputs

Communications interfaces.

EXP1013 | Ethernet interface with Web server function

EXP1015 | GPRS/GSM modem

General characteristics for RGK600 - RGK601 - RGK610 - RGK700 - RGK750 - RGK800

- Power supply: 7...33VDC
- VAC inputs: mains and generator L1-L2-L3-N
- Voltage control for one, two and three phase systems with or without neutral
- Rated measurement voltage range:
 - 100...480VAC for RGK600, RGK601, RGK610 and RGK750
 - 30...600VAC for RGK700 and RGK800
- Frequency measurement range: 45...65Hz
- Programmable VT ratio
- Current measurement range (3 PH): 0.050...6A or 0.050...1.2A
- Graphic LCD: 128x80 pixels with backlight
- 1 USB/optical and Wi-Fi port on front for programming
- Engine running detection: “D+”, generator voltage and frequency
- Engine speed inputs: “W” or Magnetic “Pick-up” (RGK601 excluded)
- 1 CANbus-J1939 port (RGK600 and RGK610 excluded)
- 3 analog ohmic inputs for oil pressure, engine temperature and fuel level control
- 1 built-in alarm remote port
- Non-volatile memory for event storage
- Alarm, event and parameter text in 5 languages
- Alarm text customisable (8 alarms)
- Event log
- Modbus-RTU and Modbus-ASCII communication protocols (RGK600 and RGK601 excluded)
- Compatible with **Synergy**, **Synergy_{cloud}** and **Xpress** software
- 1 slot for EXP modules for RGK610
- 2 slots for EXP modules for RGK750
- 3 slots for EXP modules for RGK800.

For RGK700 - RGK750 - RGK800 only

- PLC logic for inputs, outputs and internal status
- Degree of protection: IEC IP65 on front.

For RGK700 - RGK800 only

- 1 communication port: RS232 for RGK700; RS485 for RGK800
- Degree of protection: IEC IP65 on front; suitable for use with UL/CSA Type 4X outdoor enclosure installation.

For RGK800 only

- Neutral current measurement range: 0.050...6A or 0.050...1.2A
- 400Hz frequency support
- 1 programmable analog input
- Modbus-TCP communication protocol
- Current leakage control towards earth/ground
- Clock-calendar (RTC).

Certifications and compliance

Certifications obtained: UL Listed, for USA and Canada (cULus - File E93601), as Auxiliary Devices - Generator controllers except for RGK750; EAC (except for RGK750). Compliant with standards: IEC/EN/BS 61010-1, IEC/EN/BS 61000-6-2, IEC/EN/BS 61000-6-3, UL 508, CSA C22.2 n° 14.

Synergy, **Synergy_{cloud}**, and **Xpress** software
See Section 30.

EXP series expansion modules
See Section 31, page 2.

Paralleling controllers for mains-generator and generator-generator



RGK900SA - RGK900

Order code	Description	Qty per pkg	Wt [kg]
	RS485 port and USB/optical and Wi-Fi point programming port on front. Expandable with EXP... modules		
RGK900SA	Stand-alone controller. Paralleling control among generating sets	1	1.040
RGK900	AMF (Automatic Mains Failure) controller. Mains-generator paralleling control	1	1.040
RGK900MC	Mains-ATS (Automatic Transfer Switching) controller. Control of mains, automatic transfer switching (ATS) and paralleling on multiple generators controlled by RGK900SA.	1	1.040

Order code	Description
EXPANSION MODULES FOR RGK900... Inputs and outputs.	
EXP1000	4 opto-isolated digital inputs
EXP1001	4 opto-isolated static outputs
EXP1002	2 digital inputs and 2 static outputs, opto-isolated
EXP1003	2 relay outputs rated 5A 250VAC
EXP1004	2 opto-isolated analog inputs 0/4-20mA or PT100 or 0-10V or 0...±5V
EXP1005	2 opto-isolated static outputs 0/4-20mA or 0-10V or 0...±5V
EXP1008	2 opto-isolated digital inputs and 2 relay outputs rated 5A 250VAC
EXP1041	2 thermocouple inputs, 2 static outputs
Inputs and outputs.	
EXP1042T	6 digital inputs, PCB tropicalized
EXP1043T	4 digital input and 2 static outputs, PCB tropicalized
Communications interfaces.	
EXP1010	Opto-isolated USB interface
EXP1011	Opto-isolated RS232 interface
EXP1012	Opto-isolated RS485 interface
EXP1013	Ethernet interface with web server function
EXP1015	GPRS/GSM modem



EXP10...

EXP series expansion modules
See Section 31, page 2.

General characteristics

- Power supply: 7...36VDC
- VAC inputs: mains L1-L2-L3-N (not RGK900SA)
- VAC inputs: generator L1-L2-L3-N
- Voltage measurement rated value: 600VAC (UL/CSA)
- Voltage measurement range: 30...720VAC
- Frequency measurement range: 45...65Hz or 360...440Hz
- Programmable VT ratio
- Current measurement input (3 PH+N): 0.05...6A or 0.05...1.2A
- Fourth CT for neutral measurement or earth/ground leakage detection
- Graphic LCD, 128x112 pixels with backlight
- 13 digital inputs
- 3 relay outputs rated 8A 250VAC
- 6 static outputs rated 2A, protected
- 1 static output 50mA
- Engine running detection: "D+" generator voltage and frequency
- 1 engine speed input: "W" or "Magnetic Pick-up"
- 3 analog ohmic inputs for oil pressure, engine temperature and fuel level control
- 1 programmable analog input
- 2 analog outputs for engine speed control (governor) / voltage regulator (AVR)
- Alarm-event-parameter text in 5 languages
- Alarm text customisable (16 alarms)
- Event log
- Modbus-RTU, Modbus-ASCII and Modbus-TCP communication protocols
- PLC logic for inputs, outputs and internal status
- Compatible with Synergy, Synergy_{net} and Xpress software
- Degree of protection: IEC IP65 on front; suitable for use with UL/CSA Type 4X outdoor enclosure installation
- Built-in buzzer
- Multi-level passwords
- Sleep function (power saving mode)
- Synchronising and load sharing.

MAIN FUNCTIONS

- Menus for quick selection of rated parameter settings
- Mains / Generator controls: phase sequence, phase loss, max and min voltage and frequency, voltage asymmetry
- Programmable maintenance at various intervals
- Current leakage control towards earth/ground
- Mains-generator synchronising (ATS closed transition)
- Base-load or peak shaving management
- Paralleling supervision of generators (island mode)
- Generating set start scheduling.

Certifications and compliance

Certifications obtained: UL Listed for USA and Canada (cULus - File E93601), as Auxiliary Devices, Generator controllers; EAC.
Compliant with standards for RGK900: IEC/BS 61010-1, IEC/BS 61010-2-030, IEC/BS 61000-6-2, IEC/BS 61000-6-3, UL508, CSA C22.2 n. 14

Synergy, Synergy_{net}, and Xpress software
See Section 30.

MAINS-GENERATOR PARALLELING	ISLAND MODE	ATS AND PARALLELING OF MAINS WITH MULTIPLE GENSETS
<p>RGK900 is designed for mains-generator synchronising applications, such as:</p> <ol style="list-style-type: none"> Single generator in maintained parallel with the mains in "base-load" mode (generator power supplied at a steady rate) Single generator in maintained parallel with the mains, in peak-shaving mode (import-export - mains power is limited to constant value and load peaks during heavy demand for power are supplied by generator) Single generator in AMF with temporary parallel with the mains (for emergency, with AMF in closed transition). 	<p>RGK900SA is designed for applications with load sharing on an isolated bus, without mains:</p> <ol style="list-style-type: none"> Parallel among generators working together in island mode on power bus with load shared among them Generators connected together to maintain the power reserve (total power available minus load power) within a preset range, switching on and off generators according to a priority level. 	<p>Combination of RGK900SA and RGK900MC units is designed for load govern controls with multiple generators in parallel on power bus and mains. In these circumstances, the RGK900MC unit controls, in base-load or peak-shaving mode, the mains and power bus composed by multiple generators, each controlled by an RGK900SA.</p>

Remote units



RGK800RD



RGKRA

Alarm-status relay unit



RGKRR

Order code	Description	Qty per pkg	Wt [kg]
RGK800DSA	Remote display panel for RGK800SA controllers	1	0.820
RGK800RD	Remote display panel for RGK800 controllers	1	0.820
RGK900DSA	Remote display panel for RGK900SA controllers	1	0.980
RGK900RD	Remote display panel for RGK900 controllers	1	0.980
RGKRA	For RGK7..., RGK8..., RGK9..., controllers graphic LCD, touch screen 128x112 pixels	1	0.360

Order code	Description	Qty per pkg	Wt [kg]
RGKRR	Alarms-status relay unit 12/24VDC, 12 relay outputs, pulse input, CANbus communication port	1	0.420

Remote display panel RGK...RD characteristics

For remote controller supervision and viewing, the user operates the remote display panel as if directly in front of the generating set.

- 12/24VDC battery power supply
- Graphic LCD with backlight:
 - 128x80 pixels for RGK800...
 - 128x112 pixels for RGK900...
- 13 function and setting keys
- 10 Indication LEDs for operating modes and status
- Built-in buzzer
- 4 digital inputs
- 2 digital outputs
- Front degree of protection: IEC IP65; UL/CSA Type 4X outdoor enclosure installation
- Serial interface ports: opto-isolated RS485 (RGK...RD).

Remote display panel RGKRA characteristics

Alarm conditions can be viewed on the remote display and alarm silencing can also be activated.

- Dual 100-240VAC / 12-24VDC power supply
- Touch screen 120x112 pixel backlight graphic LCD
- Built-in buzzer
- Static (SSR) output for global alarm signalling
- Opto-isolated RS485 interface port
- Front degree of protection: IEC IP54; UL Type 1.

Alarm-status relay unit RGKRR characteristics

External relay expansion unit for alarm and status remoting.

Fixing on 35mm DIN rail (IEC/EN/BS 60715).

Communication with RGK... controllers by CANbus or pulse inputs:

- 12 relay outputs of which 5 with changeover (SPDT) contact rated 5A 250VAC / B300 and 7 N/O (SPST) contact rated 2.5A 250VAC / C300
- 12/24VDC power supply
- Up to 2 RGKRR units can be connected in cascade for a total of 24 relays
- Maximum installation distance from the RGK6... and RGK700... RGK900 controllers:
 - CANbus: 30m/33yd (high speed)
 - Inputs/Outputs: 1,000m/1,094yd (low speed).

Certifications and compliance

Certifications obtained: UL Listed, for USA and Canada (cULus – File E93601), as Auxiliary Devices, Generator controllers remote and relay units; EAC.

Comply with standards: IEC/EN/BS 61010-1, IEC/EN/BS 61000-6-2, IEC/BS 61000-6-3, UL508, CSA C22.2 n° 14.

For wiring schemes and technical characteristics, refer to technical instructions in Downloads area of local or global website www.LovatoElectric.com or consult Technical support; see contact details on inside front cover.

Communication devices for RGK4... - RGK6... - RGK7... - RGK8... - RGK9...



CX01



CX02



CX03

Order code	Description	Qty	Wt
		per pkg	
		n°	[kg]
CX01	USB/optical device with PC↔controller connecting cable for programming, data download, diagnostics and firmware upgrade	1	0.090
CX02	Wi-Fi dongle for PC ↔ controller programming, data download, diagnostics, project upload/download and controller cloning	1	0.090
CX03	GSM/GPRS penta-band antenna (850/900/1800/1900/2100MHz)	1	0.090

General characteristics

Communication and connection devices for generator set controllers RGK4... - RGK6... - RGK7... - RGK8... - RGK9... for personal computers, smartphones, tablets, modems, bus drives.

CX01

The USB/optical device, complete with cable, allows to connect RGK4... - RGK6... - RGK7... - RGK8... - RGK9... controllers to a PC without having to disconnect the power supply from the electric panel and to carry out parameter programming, data and event download, diagnostics and firmware upgrade. The PC identifies the connection as a standard USB.

CX02

By Wi-Fi connection, RGK4... - RGK6... - RGK7... - RGK8... - RGK9... controllers can be viewed by PC, smartphone and tablet with no need for cabling and to carry out parameter programming, data and event download, diagnostics project upload/download and controller cloning.

CX03

Antenna compatible with the major part of worldwide mobile networks thanks to the available frequencies at 850/900/1800/1900/2100MHz. IP67 IEC protection degree. Fixing by Ø10mm/0.39" drilling. Cable length 2.5m/7.23yd.

For wiring schemes and technical characteristics, refer to technical instructions in Downloads area of local or global website www.LovatoElectric.com or consult Technical support; see contact details on inside front cover.

Accessories



EXCCON01



EXCM4G01



EXCGLA01



EXCGLAX1



EXCGSM01

Order code	Description	Qty	Wt
		per pkg	
		n°	[kg]
Connecting cable.			
51C2	PC↔RGK... connecting cable, 1.8m/6ft long	1	0.090
Converters.			
EXCCON01	RS485/ Ethernet converter, 12...48VDC, including DIN rail fixing kit	1	0.400
Gateway.			
EXCM4G01	4G Gateway with RS485 and Ethernet port, Modbus RTU/TCP protocol	1	0.300
EXCGLA01	Gateway data logger for data collecting via Modbus from the device in the field. Publishing of the data to supervision software, also in Cloud	1	0.600
EXCGLAX1	2G/4G modem communication module for EXCGLA01	1	0.160
GSM Modem (modular - 4U). IP69K exterior aerial with 2.5m cable. RJ45-USB programming cable (included).			
EXCGSM01	100...240VAC, 1 digital input, 1 analogic input (0...10V, 0...20mA, NTC), 1 relay output, receiving and sending SMS messages for remote controls and alarm signals	1	0.340
For RGK600..., RGK601... and RGK610 controllers.			
EXP8001	IP65 144mm/5.67" housing gasket		
For RGK4...SA.			
EXP8005	IP65 110mm/4.33" housing gasket		

General characteristics

For general characteristics of converters and gateway see section 31.

Synergy Supervision and Energy management software

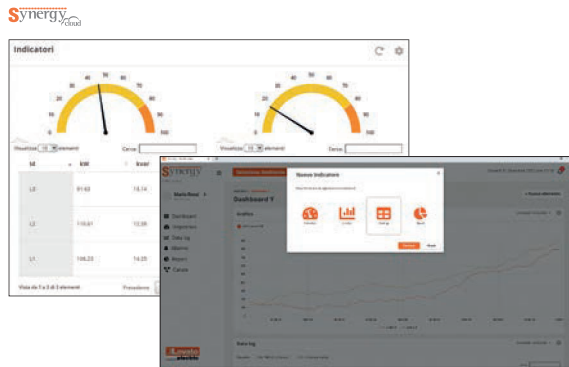

Xpress Parameter configuration and remote control software

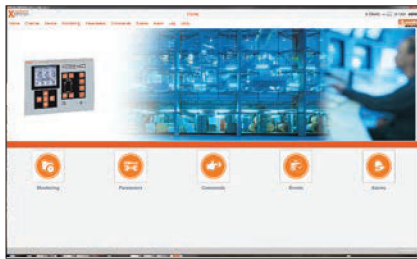

Sam1 APP

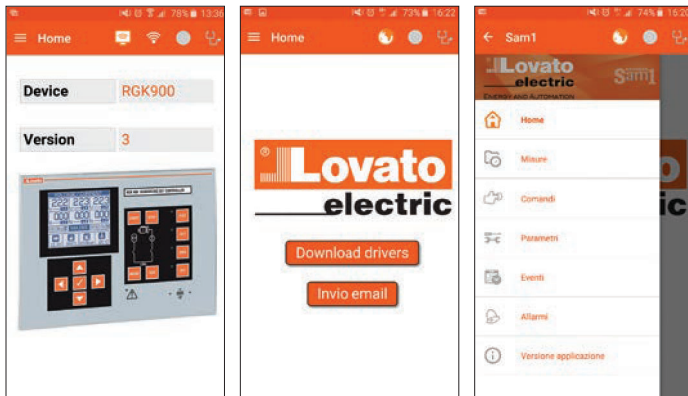

NFC APP



Supervision and Energy management software

The **Synergy** and **Synergy_{cloud}** softwares provides for the remote control and supervision of the RGK... controllers. See details given in Section 30.

Its structure and applications are based on MS SQL relational database management system. Consulting is made through popular programs for Internet browsing available across different platforms and operating systems.

It is a highly versatile system, simultaneously accessible to a large number of users/workstations via intranets, VPN or Internet.

Parameter configuration and remote control software

The **Xpress** at the beginning and just say "Express is a parameter configuration and remote monitoring software shared by the entire latest generation of RGK gen-set controllers with communication port. It can be installed in the Windows® environment and connect individually (one node at a time) to the RGK gen-set controller connected to the network.

- Supports connection via CX01 (USB) or CX02 (Wi-Fi) dongle, USB, RS232, RS485, Ethernet and modem
 - Product configuration:
 - Parameter setting
 - Project file management
 - Product firmware upgrade (via CX01)
 - Remote control:
 - Monitoring of main measurements
 - Sending commands to products
 - Reading alarms and events memory.
- See details given in Section 30.

APP for smartphone and tablets

Sam1 application allows the user to program the controller, view alarm conditions, send commands, read measurements, download statistical data and events and send retrieved data by email. The connection is made by Wi-Fi with a smartphone or tablet using CX02 dongle. It is iOS and Android compatible. For more details, see Section 30 or consult Technical support; see contact details on inside front cover.

NFC App for RGK4...SA, with integrated NFC technology, allows remote parameter configuration.

The parameters can be saved in a file for archive purposes. It is Android and iOS compatible. For more details, see Section 30 or consult Technical support; see contact details on inside front cover.

STAND-ALONE GEN-SET CONTROLLERS

RGK400SA

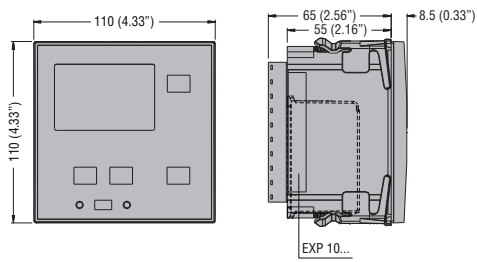

RGK420SA

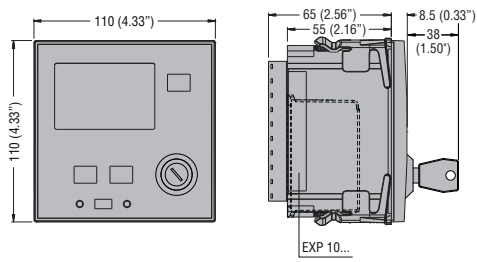

Cutout

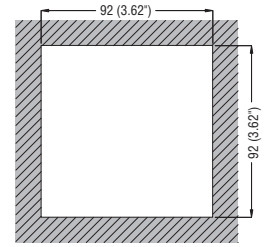

GEN-SET CONTROLLERS **RGK600...** - **RGK601...** - **RGK610**

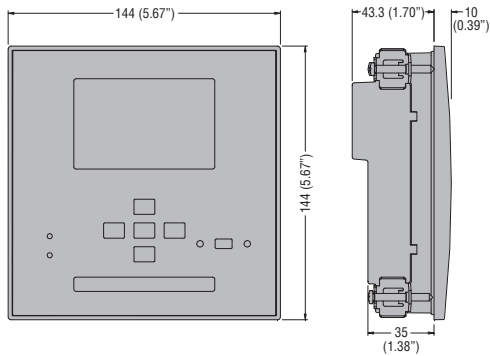

Cutout

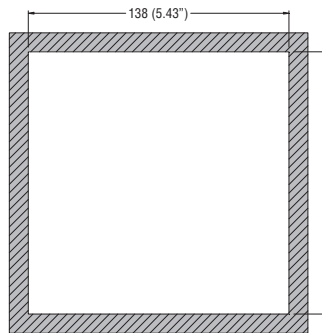

GEN-SET CONTROLLERS **RGK700...** - **RGK750...** - **RGK800...** - **RGK900...** - REMOTE DISPLAY PANELS **RGK800RD** - **RGK800RDSA** - **RGK900RD** - **RGK900RDSA**

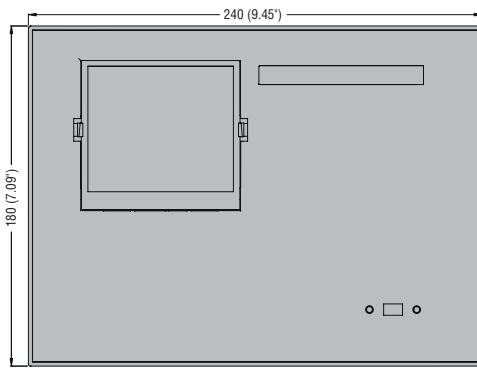

❶ RGK 700, RGK 800RD..., RGK 900RD... excluded.

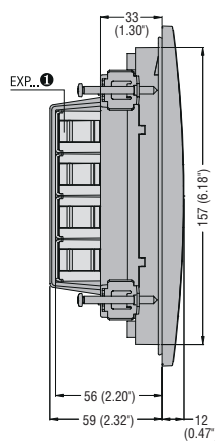

Cutout

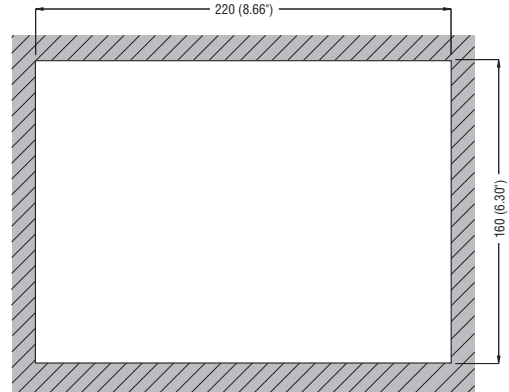

REMOTE DISPLAY UNIT **RGKRA**

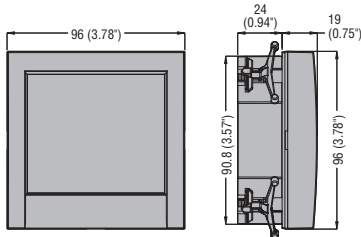

Cutout

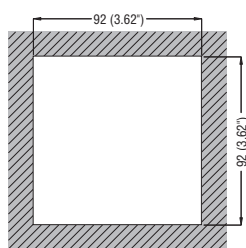

ALARM-STATUS RELAY UNIT **RGKRR**

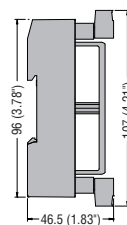
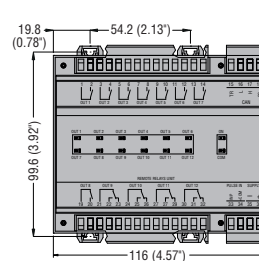

FFL - EN12845



FIRE FIGHTING ENGINE PUMP CONTROLLER

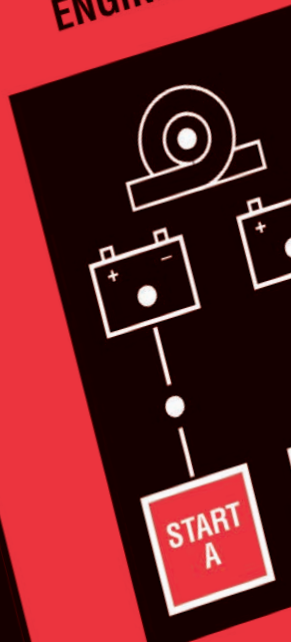

- Fire pump controllers according to EN/BS 12845
- Remote alarm panels according to EN/BS 12845
- Advanced programmable I/O functions to control the fire fighting system
- Expandable with EXP modules
- Controllers and expansion modules with tropicalized PCB
- Controllers with built-in NFC technology
- RS485 and Ethernet communication interfaces
- Setup and supervision software
- Modem control for sending alarm messages and emails.

Fire pump controllers

Diesel engine fire pump controllers 29 - 2

Electric fire pump controllers 29 - 3

Remote alarm panels for fire pump applications 29 - 4

Communication devices, software and accessories 29 - 5

Dimensions 29 - 6

Technical characteristics 29 - 7

SEC. - PAGE



Page 29-2

DIESEL ENGINE FIRE PUMP CONTROLLERS

- Crank cycle according to EN/BS 12845
- Batteries monitoring
- Advanced programmable functions for fire fighting systems
- AC voltage monitoring
- Possibility of setup via NFC technology and APP
- Built-in RS485 communication
- PLC logic integrated.



Page 29-3

ELECTRIC FIRE PUMP CONTROLLERS

- Designed in accordance to EN/BS 12845
- 1 phase or 3 phase voltage measure inputs
- 1 phase or 3 phase current measure inputs
- 24VAC or 230VAC power supply
- Advanced programmable functions for fire fighting systems
- Possibility of setup via NFC technology and APP
- Built-in RS485 communication
- PLC logic integrated.



Page 29-4

REMOTE ALARM PANELS FOR FIRE PUMP APPLICATIONS

- Remote panels according to EN/BS 12845
- LED or LCD display versions
- Pushbutton to silence the siren and test the LEDs
- Built-in buzzer.



Page 29-5

COMMUNICATION DEVICES, SOFTWARE AND ACCESSORIES

- Communication interfaces
- Additional digital and analog inputs and outputs
- GPRS-GSM module
- Gateway
- Supervision, setup and remote control software
- APP.

Diesel engine fire pump controllers



FFL...DP



Order codes	Description	Qty per pkg	Wt
		n°	[kg]
FFL700DP	Controller for diesel engine fire pumps in accordance with EN/BS 12845, power supply 12/24VDC, built-in RS485	1	0.980
FFL800DP	Controller for diesel engine fire pumps in accordance with EN/BS 12845, power supply 12/24VDC, built-in RS485, expandable with EXP... expansion modules	1	0.980



The app can be downloaded from Google Play Store and App Store.



Order code	Description
EXPANSION MODULES. Inputs and outputs.	
EXP1008T	2 opto-isolated digital inputs and 2 relay outputs rated 5A 250VA, tropicalized PCB
EXP1042T	6 digital inputs, tropicalized PCB
EXP1043T	4 digital inputs and 2 static outputs, tropicalized PCB
EXP1004T	2 opto-isolated analog inputs 0/4-20mA or PT100 or 0-10V or 0...±5V, tropicalized PCB
Communication ports.	
EXP1012T	Opto-isolated RS485 interface, tropicalized PCB
EXP1013T	Ethernet interface, tropicalized PCB
EXP1015	GPRS/GSM modem



EXP10...

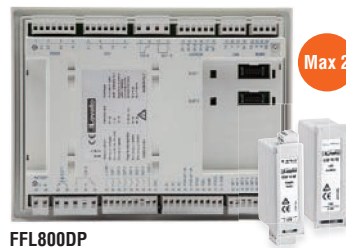

FFL800DP

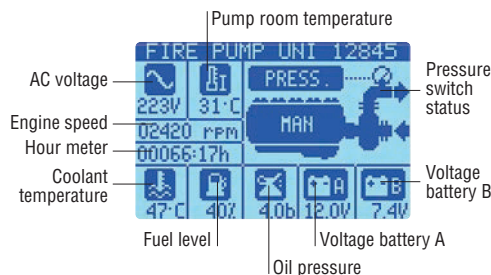

General characteristics

FFL...DP controllers integrate all the functions required by the EN/BS 12845 standard regarding the diesel engine fire pump management and help the user to monitor and maintain the performance of the entire firefighting system.

The backlit graphic 128x80 pixel LDC display ensures high visibility in low light conditions.

Inputs and outputs are programmable and the number can be increased with the I/O expansion modules, moreover they can be managed by the integrated PLC logic.

This all means a complete solution with less wiring, less components and less programming to set up the firefighting system. Within the main page, it is possible to see all the information about the engine fire pump.

Functions for the maintenance and the test of the firefighting system are available directly on the display. Furthermore there is the possibility to receive remotely this information by the digital outputs or the Modbus communication through the built-in RS485.

The controller monitors constantly the temperature inside the pump room using the integrated or an external temperature sensor and the status of the auxiliary voltage with the single-phase AC voltage measurement input.

Features

- Engine control, monitoring and protection
- Backlit graphic LCD display with multilingual text and synoptic
- Texts in 5 languages (ENG, ITA, FRA, SPA, DEU)
- Customizable texts via **Xpress** software (see section 30)
- Dedicated page for LED test and commissioning
- Dedicated page for jockey pump monitoring
- Dual DC power from two separate batteries 12/24VDC
- Input of single-phase AC voltage measurement for charger power supply monitoring
- 9 LED indicators: mode selection, batteries selection, battery status, pump activated, warning indication
- 2 password levels
- Built-in RS485 port
- Built-in real time clock
- Built-in NTC temperature sensor
- Storage of last 128 events
- Automatic starting sequence according to EN/BS 12845
- Communication interface by front optical port with CX01 and CX02 device using USB or Wi-Fi connections
- NFC contactless interface for programming via **NFC** App freely downloadable from Google Play Store and App Store
- Isolated RS485 serial port for supervision (compatibility with **Synergy** and **Synergy_{com}** software)
- Expandability with EXP... modules tropicalized PCB (only FFL800DP)
- Compatibility with FFLRA... remote alarm panels.

Operational characteristics

- Power supply voltage: 12 or 24VDC
- Voltage measurement inputs:
 - Rated voltage Ue: 100...240VAC
 - Measurement range: 50...264VAC
 - Frequency range: 45...65Hz
- Input to monitor the starter pinion
- NTC probe input:
 - measuring range: -40...+85°C
- Engine running input (D+)
- Programmable digital inputs: 10 - Negative
- Programmable relay outputs: 10
- Programmable static outputs: 1
- 3 programmable resistive sensors
- Compatible software: **Sam1**, **Xpress**, **NFC**, **Synergy** and **Synergy_{com}** software (see section 30)
- Degree of protection: IP65 on front. IP20 at rear
- PCB tropicalized
- Operating temperature: -25...+70°C.

Synergy, **Xpress** and **Sam1** software, **NFC** App
See Section 30.

EXP... series expansion modules
See Section 31, page 2.

Compliance

Compliant with standards: UNI EN/BS 12845, IEC/EN/BS 61010-1, IEC/EN/BS 61010-2-030, IEC/EN/BS 61000-6-2, IEC/EN/BS 61000-6-3.

Electric fire pump controllers



FFL...EP



Order codes	Description	Qty per pkg	Wt
		n°	[kg]
FFL700EP	Controller for electric fire pumps in accordance with EN/BS 12845, power supply 24VAC, built-in RS485	1	0.980
FFL800EP	Controller for electric fire pumps in accordance with EN/BS 12845, power supply 24VAC or 110...240VAC, built-in RS485, expandable with EXP... expansion modules	1	0.980



The app can be downloaded from Google Play Store and App Store.



Order code	Description
EXPANSION MODULES. Inputs and outputs.	
EXP1008T	2 opto-isolated digital inputs and 2 relay outputs rated 5A 250VA, tropicalized PCB
EXP1042T	6 digital inputs, tropicalized PCB
EXP1043T	4 digital inputs and 2 static outputs, tropicalized PCB
EXP1004T	2 opto-isolated analog inputs 0/4-20mA or PT100 or 0-10V or 0...±5V, tropicalized PCB
Communication ports.	
EXP1012T	Opto-isolated RS485 interface, tropicalized PCB
EXP1013T	Ethernet interface, tropicalized PCB
EXP1015	GPRS/GSM modem



EXP10...

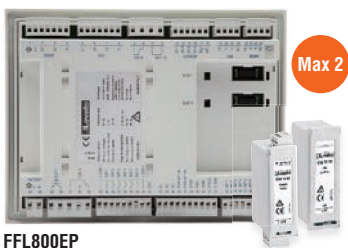

FFL800EP

Max 2

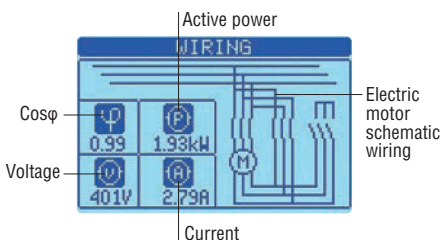

Single phase pump applications:

- Skyscrapers
- Residences
- Civil Buildings.



3-phase pump applications:

- Industry
- Shopping malls
- Hospitals
- Warehouses.
- Etc.



General characteristics

FFL...EP controllers integrate all the functions required by the EN/BS 12845 standard regarding the electric fire pump management and help the user to monitor and maintain the performance of the entire firefighting system. The backlit graphic 128x80 pixel LDC display ensures high visibility in low light conditions. Inputs and outputs are programmable and the number can be increased with the I/O expansion modules, moreover they can be managed by the integrated PLC logic. This all means a complete solution with less wiring, less components and less programming to set up the firefighting system. Within the main page, it is possible to see all the information about fire pump and the electrical engine. Functions for the maintenance and the test of the firefighting system are available directly on the display. Furthermore there is the possibility to receive remotely this information by the digital outputs or the Modbus communication through the built-in RS485. The controller monitors constantly the temperature inside the pump room using the integrated or an external temperature sensor.

Features

- Possibility of single phase or 3-phase connection of the electric fire pump controller.
- Electric motor control, monitoring and protection
- Backlit graphic LCD display with multilingual text and synoptic
- Texts in 5 languages (ENG, ITA, FRA, SPA, DEU)
- Customizable texts via Xpress software (see section 30)
- Dedicated page for LED test and commissioning
- Dedicated page for jockey pump monitoring
- 8 LED indicators: electric pump running, main status, electric motor status, starting request, global alarm, failure to start, stop enabled, automatic start excluded
- 2 password levels
- Built-in RS485 port
- Built-in real time clock
- Built-in NTC temperature sensor
- Storage of last 128 events
- Communication interface by front optical port with CX01 and CX02 device using USB or Wi-Fi connections
- NFC contactless interface for programming via NFC App freely downloadable from Google Play Store and App Store
- Isolated RS485 serial port for supervision (compatibility with Synergy and Synergy_{max} software)
- Expandability with EXP... modules tropicalized PCB (only FFL800EP)
- Compatibility with FFLRA... remote alarm panels.

Operational characteristics

- Power supply voltage: 24VAC (FFL700EP), 24VAC and 110...240VAC (FFL800EP)
- Voltage measurement inputs:
 - 1 phase or 3 phases
 - Rated voltage Ue: 100...600VAC
 - Measurement range: 80...720VAC
 - Frequency range: 45...65Hz
- 1 phase or 3 phases current measurements inputs: 1/5A
- NTC probe input:
 - measuring range: -40...+85°C
- Programmable digital inputs: 8 - Negative
- Programmable relay outputs: 7 (FFL700EP), 9 (FFL800EP)
- Programmable static outputs: 1
- Compatible software: Sam1, Xpress, NFC, Synergy and Synergy_{max} software (see section 30)
- Degree of protection: IP65 on front. IP20 at rear
- Tropicalized PCB
- Operating temperature: -25...+70°C.

Synergy, Xpress and Sam1 software, NFC App
See Section 30.

EXP... series expansion modules
See Section 31, page 2.

Compliance

Compliant with standards: UNI EN/BS 12845, IEC/EN/BS 61010-1, IEC/EN/BS 61010-2-030, IEC/EN/BS 61000-6-2, IEC/EN/BS 61000-6-3.

Remote alarm panels for fire pump applications



FFLRA200



FFLRA400



EXP10...

Order codes	Description	Qty per pkg	Wt
		n°	[kg]
FFLRA200	Remote alarm panel with LED, buzzer, pushbutton to silence the siren and test the LEDs. It supports up to 2 fire pump controllers	1	1.120
FFLRA400	Remote alarm panel with LCD graphic display (128x80pxls), buzzer, expandable with 2 EXP... expansion modules. It supports up to 3 fire pump controllers	1	2.670



The app can be downloaded from Google Play Store and App Store.



Order code	Description
EXPANSION MODULES FOR FFLRA400 (2 AVAILABLE SLOTS) Inputs and outputs.	
EXP1000	4 opto-isolated digital inputs
EXP1001	4 opto-isolated static outputs
EXP1002	2 digital inputs and 2 static outputs, opto-isolated
EXP1003	2 relay outputs 5A 250VAC
EXP1008	2 opto-isolated digital inputs and 2 5A relay outputs 250VAC
EXP1042T	6 digital inputs, tropicalized PCB
EXP1043T	4 digital inputs and 2 static outputs, tropicalized PCB
Communication ports.	
EXP1010	Opto-isolated USB interface
EXP1011	Opto-isolated RS232 interface
EXP1012	Opto-isolated RS485 interface
EXP1013	Opto-isolated Ethernet interface
EXP1015	GPRS/GSM modem

General characteristics FFLRA200

FFLRA200 is a simple remote annunciator: the buzzer will sound in case of alarm and the LEDs will indicate the presence of the relative alarms. The labels for LEDs descriptions are included in the package. A template can be downloaded from www.LovatoElectric.com, products section for alarms labels model. The communication between the remote annunciator and the FFL controller is performed by means of a pulsed signal and up to 2 FFL controllers can be connected. Using the front buttons, it is possible to silence the alarm occurred and test the LEDs. The alarms notified on the remote panel are configurable directly on FFL controllers. No setup on the remote panel is required. 2 LEDs display the status of the communication and the remote panel power supply.

Operational characteristics

- Power supply voltage: 100...240VAC
- AC voltage range: 90...264VAC
- Frequency range: 45...66Hz
- Arrangement for internal battery support is built-in (battery is not included)
- Compatible software: **NFC** App freely downloadable from Google Play Store and App Store
- Degree of protection: IP40
- Operating temperature: -25...+50°C.

Compliance

Compliant with standards: UNI EN/BS 12845, IEC/EN/BS 61010-1, IEC/EN/BS 61010-2-030, IEC/EN/BS 61000-6-2, IEC/EN/BS 61000-6-3.

General characteristics FFLRA400

FFLRA400 is an advanced remote annunciator with backlit graphic LCD display. It is expandable with 2 EXP modules to increase its features in terms of communication, digital inputs and digital outputs.

The communication between the remote panel and the FFL controller is performed by means of a pulsed signal or through RS485 if the EXP1012 expansion module is added. Up to 3 FFL controllers can be connected to one FFLRA400 with RS485 communication. On the front of the remote alarm panel, LEDs and a buzzer are present to display and notify the alarms and to see them from a distance; at the same time a complete description of the alarms is available on the graphic LCD display.

The texts are available in 10 different languages: English, Italian, French, Spanish, German, Portuguese, Russian, Polish, Czech and Turkish.

By fitting the EXP1015 expansion module, the remote annunciator is automatically equipped and configured with a GSM/GPRS modem. Once a data-enabled SIM card is inserted, SMS with alarms or events and email messages can be transmitted by the remote annunciator.

Operational characteristics

- Power supply voltage: 100...240VAC
- AC voltage range: 90...264VAC
- Frequency range: 47...63Hz
- Arrangement for internal battery support (battery not included) is built-in
- 5 digital inputs
- 2 digital outputs
- Expandability with EXP... modules (2 available slots)
- Optical port on front for CX01 and CX02 device
- Compatible software: **S_{am}1**, **X_{press}**, **NFC**, **S_{synergy}** and **S_{synergy}** software (see section 30)
- Degree of protection: IP40
- Operating temperature: -25...+50°C.

S_{synergy}, **X_{press}** and **S_{am}1** software, **NFC** App
See Section 30.

EXP... series expansion modules
See Section 31, page 2.

Compliance

Compliant with standards: UNI EN/BS 12845, IEC/EN/BS 61010-1, IEC/EN/BS 61010-2-030, IEC/EN/BS 61000-6-2, IEC/EN/BS 61000-6-3.

Communication devices



CX01



CX02



CX03

Order code	Description	Qty per pkg	Wt
		n°	[kg]
CX01	USB connection device PC↔FFL... with optical connector for programming, data download, diagnostics and firmware upgrade	1	0.090
CX02	Wi-Fi connection dongle PC↔FFL... for data download, diagnostics and firmware upgrade, project upload/download and controller cloning	1	0.090
CX03	GSM/GPRS penta-band antenna (850/900/1800/1900/2100MHz)	1	0.090

General characteristics

Communication and connection devices for fire pump controllers FFL700... - FFL800... - FFLRA400 for personal computers, smartphones, tablets, modems, bus drives.

CX01

The USB/optical device, complete with cable, allows to connect fire pump controllers to a PC without having to disconnect the power supply from the electric panel and to carry out:

- Parameter programming
- Settings copy to external units
- Data and event download
- Carry out the diagnostics
- Firmware upgrade.

The PC identifies the connection as a standard USB.

CX02

By Wi-Fi connection, FFL700..., FFL800... controllers and FFLRA400 remote alarm panel can be viewed by PC, smartphone and tablet with no need for cabling and to carry out:

- Parameter programming
- Data and event download
- Diagnostics project upload/download and controller cloning.

CX03

Antenna compatible with the majority of worldwide mobile networks thanks to the available frequencies at 850/900/1800/1900/2100MHz.

- IP67 IEC protection degree.
- Fixing by Ø10mm/0.39" drilling.
- Cable length 2.5m/2.73yd.

For dimensions, wiring schemes and technical characteristics, refer to technical instructions in downloads of local or global website or consult Technical support; see contact details on inside front cover.

Accessories



EXCCON01



EXCM4G01



EXCGLA01



EXCGLAX1



EXCGSM01

Order code	Description	Qty per pkg	Wt
		n°	[kg]
Connecting cable.			
51C2	PC↔FFL... connecting cable, 1.8m/6ft long	1	0.090
Converters.			
EXCCON01	RS485/ Ethernet converter, 12...48VDC, including DIN rail fixing kit	1	0.400
Gateway.			
EXCM4G01	4G Gateway with RS485 and Ethernet port, Modbus RTU/TCP protocol	1	0.300
EXCGLA01	Gateway data logger for data collecting via Modbus from the device in the field. Publishing of the data to supervision software, also in Cloud	1	0.600
EXCGLAX1	2G/4G modem communication module for EXCGLA01	1	0.160
GSM Modem (modular - 4U). IP69K outside aerial with 2.5m cable. RJ45-USB programming cable (included).			
EXCGSM01	100...240VAC, 1 digital input, 1 analog input (0...10V, 0...20mA, NTC), 1 relay output, receiving and sending SMS messages for remote controls and alarm signals	1	0.340

General characteristics

For general characteristics of these accessories see section 31.

new

new

FFL700... - FFL800...

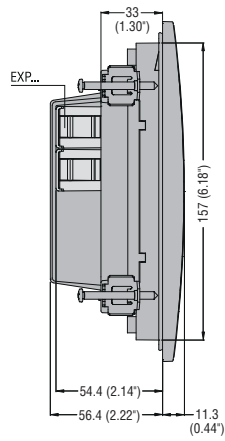
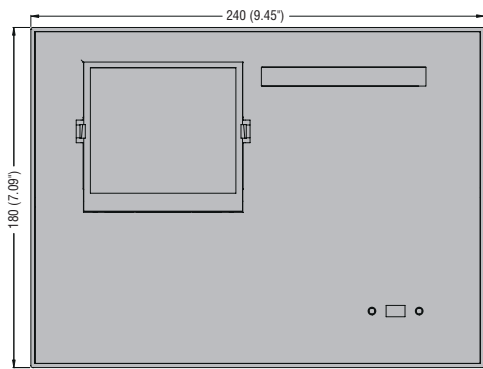

Drilling for surface fixing

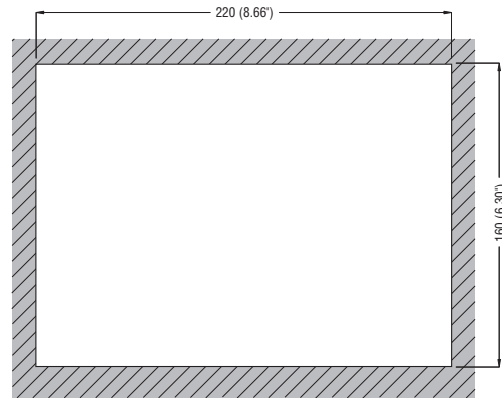

FFLRA200

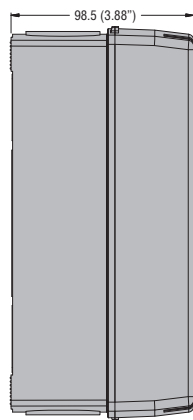
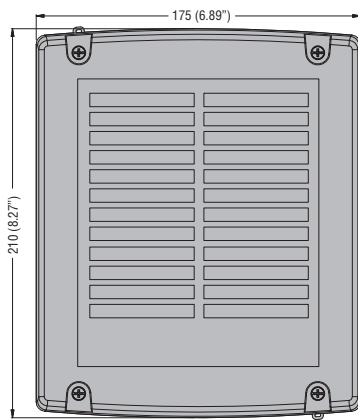

Drilling for surface fixing

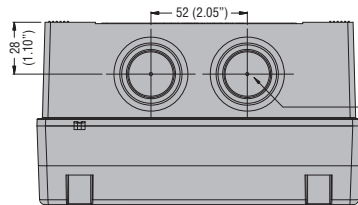
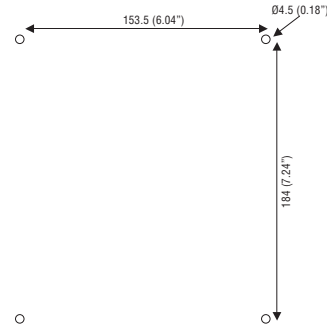

PG16 / M25
PG29 / M32
knockouts on top
and bottom

FFLRA400

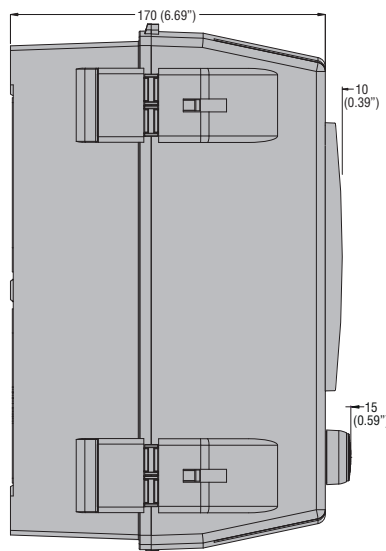
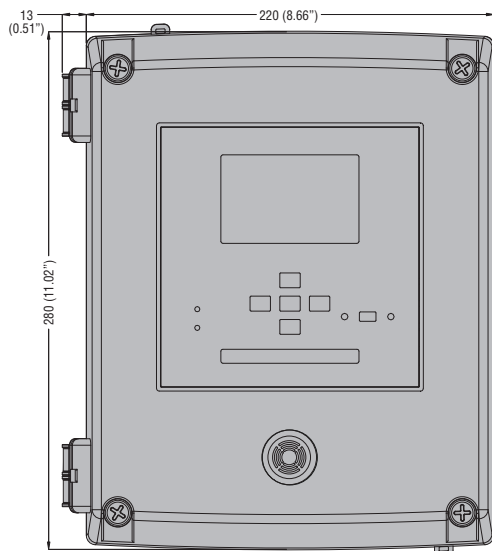

TYPE	FFL...DP	FFL...EP
SUPPLY		
Rated voltage	12...24VDC	24VAC (FFL700EP); 24VAC/110...240VAC (FFL800EP)
MAIN VOLTAGE INPUT		
Rated voltage Us	100...250VAC	100...600VAC
Measuring range	90...264VAC	80...720VAC
Frequency range	45...66Hz	
ENGINE RUNNING INPUT (D+) FOR PRE-EXCITED ALTERNATOR		
Voltage range	0...36VDC	—
Maximum input current	0.5mA	—
Maximum voltage at D+ terminal	12 or 24VDC (battery voltage)	—
Excitation current	210mA 12VDC / 130mA 24VDC	—
ENGINE SPEED INPUT: "PICK-UP/W" INPUT		
Input type	AC	—
Minimum reading frequency voltage: high sensitivity	≥2.8Vpp (1Vrms) at 40Hz ≥10Vpp (3.5Vrms) at 2000Hz	—
Minimum reading frequency voltage: low sensitivity	≥3.7Vpp (1.3Vrms) at 40Hz ≥7Vpp (2.5Vrms) at 2000Hz	—
Measurement input impedance	> 100kΩ	—
Maximum voltage	84Vpp (30Vrms)	—
PINION INPUT		
Voltage range	0...33VDC	—
Current input	≤8mA	—
Threshold	Adjustable	—
Input delay	Adjustable	—
NTC PROBE INPUT		
Type of sensor	NTC (LOVATO code NTC01)	
Measuring range	-40...+85°C	
Maximum connection length	3m	
DIGITAL INPUTS		
Input type	Negative	
Input current	≤6mA	
Low input signal	≤1.25V (typical 1.9V)	
High input signal	≥4.9V (typical 3.8V)	
Input signal delay	≥50ms	
OUTPUTS		
Outputs 1-2	2 x 1NO - 12A 30VAC/DC	—
Battery voltage output	2NO + 1 common terminal	—
Output 3	8A 30VDC (DC1); 30VDC 1A pilot duty	—
Output 4	4A 30VDC (DC1)	—
Outputs 5-10	6 x 1C/O - 8A 250VAC (AC1); 1.5A 250VAC (AC15)	—
Alarm outputs	—	4 x C/O - 8A 250VAC (FFL700EP) 6 x C/O - 8A 250VAC (FFL800EP)
Motor command output	—	3NO - 16A 250VAC
STATIC OUTPUT		
Output type	NO	
Rated voltage	10...30VDC	
Maximum current	50mA	
RS485 SERIAL INTERFACE		
Interface type	Isolated	
Baud-rate	Programmable 1200...115200bps	
Insulation voltage (RS485 – V Batt.)	1kV=	
AMBIENT CONDITIONS		
Operating temperature	-25...+70°C	
Storage temperature	-30...+80°C	
Relative humidity	<80% (IEC/EN/BS 60068-2-78)	
CONNECTIONS		
Terminals type	Removable screw-type	
Wire cross-section (min. and max.)	0.2...2.5mm ² (24...12AWG)	
Tightening torque	0.56Nm (5lb.in)	
HOUSING		
Installation	Flush-mount	
Material	Polycarbonate	
Degree of protection	IP65 Frontal; IP20 on terminals	



- Multiclient web based monitoring software, Cloud and on premises solutions.
- Software to monitor and configure LOVATO Electric devices.
- APP for monitoring and configuration via Wi-Fi or NFC.

Software

Synergy : supervision and Energy Management software	30 - 2
Xpress : configuration and remote control software	30 - 5

APP

Sam1 : APP for smartphone and tablet to setup and monitor LOVATO Electric devices	30 - 6
NFC : APP for programming LOVATO Electric devices via NFC technology	30 - 7

SEC. - PAGE

Synergy



Page 30-2

SUPERVISION AND ENERGY MANAGEMENT SOFTWARE

- Windows services and web applications to collect and publish device data on the most popular browsers
- Data management in MS SQL database
- Multi-user access either in local area networks or internet
- Cloud service available on LOVATO Electric portal.

Xpress

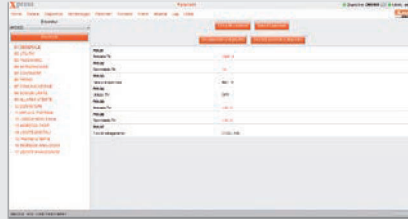

Page 30-5

CONFIGURATION AND REMOTE CONTROL SOFTWARE - FREE OF CHARGE

- Parameter setting
- Point-by-point monitoring
- Memory module management
- Free of charge.



Sam1



Page 30-6

APP FOR SMARTPHONES AND TABLETS

- Users can program the device, view alarm conditions, send commands, read measurements, download statistical data and events and send retrieved data by email
- iOS and Android compatible
- Free of charge.



NFC

Page 30-7

APP FOR PROGRAMMING VIA NFC TECHNOLOGY

- Parameter setting with NFC technology
- Access without the need to power up the LOVATO Electric device
- iOS and Android compatible
- Free of charge.

Synergy

Synergy is a supervision and Energy Management web-based software that provides the monitoring and control of the electrical installation, from every computer or mobile device through the most popular web browsers in a simple and efficient way.

It is valid software to sustain the activities indicated by the standard EN ISO 50001 "Energy Management systems. Requirements with guidance for use".

In addition to electrical quantities, it allows to check all environmental and process information (operating status, alarms, etc.), acquired from LOVATO Electric products, equipped with communication port, and thereby to carry out commands and parameterising.

It is possible to create, without limitations, browsable pages with widgets for charts, data tables, measure indicators and alarm conditions. Data is available to be downloaded to user's computers and possibly to be sent to either a list of e-mail recipients or to FTP servers. Users can configure the exported files according to their needs.

Synergy's flexibility lets third party devices which are able to exchange data through Modbus protocol be included in the monitoring system and third party softwares gather data for further elaborations by connecting to web API service.

Third party softwares are able to access **Synergy** database by means of web API call. Third party Modbus devices are able to access to **Synergy** by means of customizable interface drivers.

FUNCTIONALITY

- Communication with all LOVATO Electric measurement and control devices, via serial ports, Ethernet or modem
- Integration of third party devices with Modbus
- Reading of instantaneous values
- Definition of custom pages with charts, data tables, measure indicators and alarm conditions
- Data tables which can be exported to customisable files, for example to generate reports with user's logo and post-processing elaborations
- Data access through web API service
- Energy consumption, minimum, maximum and average values of the instantaneous measures divided per time slots
- Alarm management with e-mail notification
- Parameter changing of devices in the field
- User's access level management.



ALARMS

Each value recorded in the archives (datalogs) can be associated with one or more alarms, defining for each one: an upper and lower limit, a reference calendar (for enabling/disabling), any representation in trend graphs and the option of automatically sending an e-mail. If the limits are exceeded, **Synergy** records the anomaly and reports it in the software header. A specific menu allows the display of detailed information, silencing of alarms and consultation of the datalog.

SIMPLE, GUIDED, INTUITIVE CONFIGURATION

Programming **Synergy** does not require any particular computer knowledge since specific configuring instruments have been developed to guide through the configuration of product networks, graphic pages, datalog reports and charts, in a simple and intuitive way.

SERVER-MULTICLIENT SYSTEM

Synergy structure and applications are based on a MS SQL relational database management system.

Synergy is consulted through the most popular browsers, so it's available on various platforms and operating systems. These characteristics make **Synergy** a highly versatile system, simultaneously accessible to a large number of users/workstations via intranets, VPN or Internet.

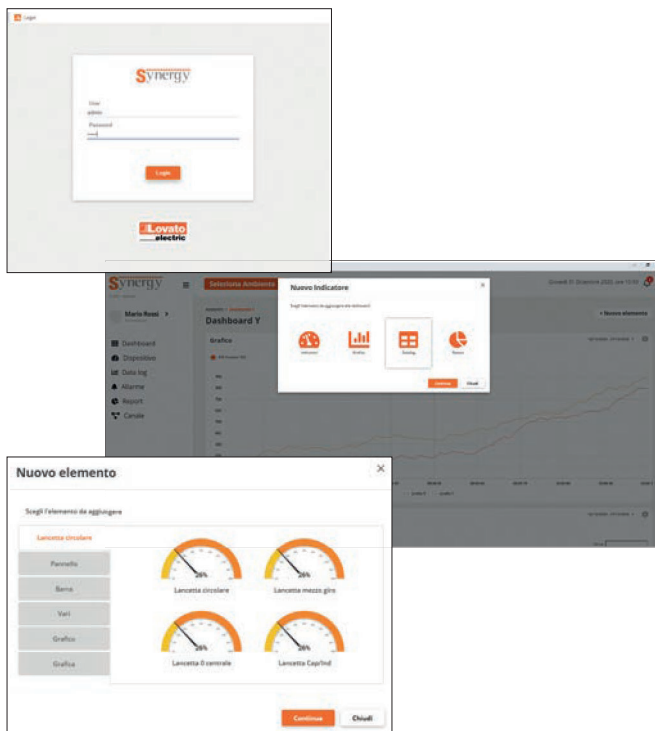

FURTHER INFORMATION

For further information on the software, consult the site:
<http://em.LovatoElectric.com>

Synergy Software

Order code	Description	Details	Provisioning
Software.			
SYN2SET	Supervision and Energy Management Synergy software	Supervision and Energy Management software web based for Windows operating system	Permanent licence
Licence.			
SYN2SLL	Synergy licence for LOVATO Electric device	Monitoring function for each LOVATO Electric device equipped by Modbus communication port	Permanent licence for single device
SYN2SLX	Synergy licence for THIRD PARTY devices	Monitoring function for each THIRD PARTY device equipped by Modbus communication port	Permanent licence for single device
SYN2SDLWS	Licence to access to Synergy database	Access function by WEB API to Synergy MS SQL database by THIRD PARTY software	Permanent licence
SYN2SLM	Licence to access to Synergy updates	Access to Synergy updates (e.g. compliant with new operating systems and new Synergy features for each LOVATO Electric or THIRD PARTY devices)	Annual subscription licence for single device
SYN2UPG	Update to Synergy2	Update from Synergy to Synergy2	Permanent licence for single device
Technical support and training.			
SYN2SCS00	Synergy technical support	Synergy technical support by phone or team viewer	Hourly rate
SYN2SCS11	Synergy on site commissioning	On site Synergy technical support: – check on field devices configuration – SYN2SET setup on customer PC – check of exchanging data between Synergy and on field devices – Synergy configuration based on customer needs – travel costs and labour hours to setup Synergy and on field devices	On site cost
SYN2SCSDRV	Interface driver development for THIRD PARTY devices	Synergy support to develop the interface driver between Synergy and THIRD PARTY devices for a maximum of 5 measurements and feasibility study by LOVATO Electric Technical support (Tel. + 39 035 4282422; E-mail: service@LovatoElectric.com)	Cost for each driver
SYN2TRAINING	Synergy training sessions (basic and advanced courses)	Introduction to Energy Management topics. Measurement devices: range and selection criteria with case studies. Synergy software key features for monitoring and supervising: architecture and access, channels, tools, graphs, data logs, pages and access criteria. Practical exercises. For further information visit EVENTS section on www.LovatoElectric.com	Confirmed

Example of a **Synergy** on premises solution:

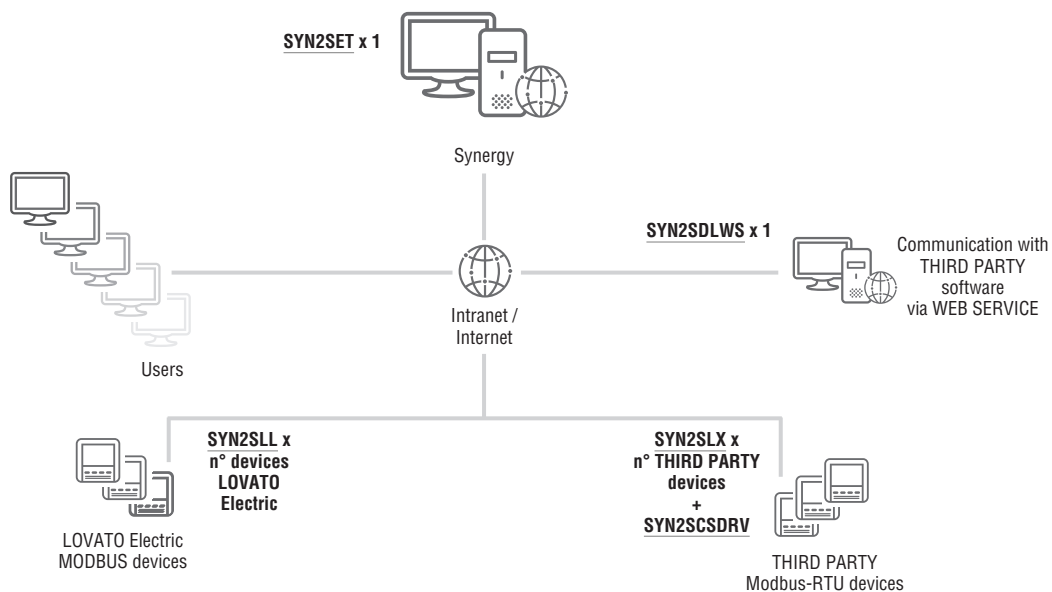

Synergy cloud

Synergy Cloud is a subscription service that allows the supervision and control of systems via LOVATO Electric Cloud server accessible from any computer or mobile device through the most common web browsers. The functions of the **Synergy** Cloud software are the same as those made available with the local installation of the **Synergy** software but without the need to install any software and without the need of a dedicated server at company premises. The costs of purchase, configuration and maintenance of the hardware and software necessary for energy monitoring are saved.

The devices in the field send the monitored data to the Gateway Data Logger (EXCGLA01) device which collects and represents them at the integrated web server.

Synergy Cloud lets the user remotely view the instantaneous monitored data, receive reports about alarms via email and execute commands (SYN2CLRW licence). With the appropriate licence for supervision and Energy Management (SYN2CLL licence), **Synergy** Cloud periodically receives via Internet (either wired or mobile network) the data collected by the Gateway Data Logger in order to store historical data, process and represent them graphically as well.

SECURITY

The security of the data is guaranteed by HTTPS encryption with certificate between server and client PC, by daily backup of the data collected and by state-of-the-art firewall for server access.

The **Synergy** Cloud solution:

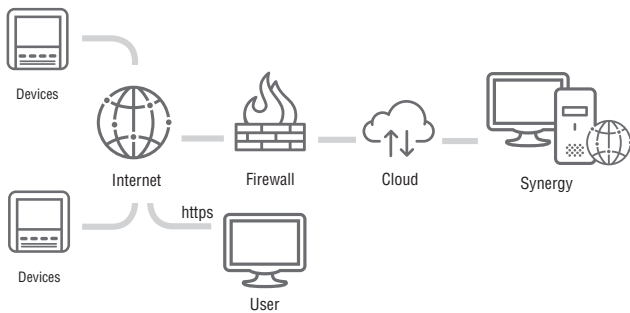

FEATURES

- Extremely intuitive interface: no particular technical background required
- Data access from all over the world thanks to the Internet and common browsers
- Specific design for client requirements (selection of measurement scenarios)
- Low data traffic thanks to the extreme economy of the protocol used (Modbus)
- Instantaneous data acquisition from various devices that can even be located in different sites
- Simple and clear reporting of all energy data
- No investment in software database or server
- Extremely secure data thanks to HTTPS and daily backup
- Automatic updates included
- Limited subscription cost.

Order code	Description	Details	Provisioning
Licence.			
SYN2CLRW	Licence for basic remote view	Remote view of instantaneous data, creation of alarms and relevant mail sending, execution of commands	Annual subscription licence (365 days) for each device
SYN2CLL	Synergy Cloud licence for LOVATO Electric device	Supervision, Energy Management, data storage functions for a LOVATO Electric device with Modbus communication	Annual subscription licence (365 days) for each device
SYN2CLX	Synergy Cloud licence for THIRD PARTY devices	Supervision, Energy Management, data storage functions for a third party device with Modbus communication	Annual subscription licence (365 days) for each device
SYN2CDLWS	Licence to access to Synergy database	Access function by WEB API to Synergy MS SQL database by THIRD PARTY software	Annual subscription licence (365 days)
Technical support.			
SYN2SCS00	Synergy Technical support	Synergy Technical support by phone or team viewer	Hourly rate
SYN2SCS11	Synergy on site commissioning	On site Synergy technical support: <ul style="list-style-type: none"> - check on field devices configuration - SYN2SET setup on customer PC - check of exchanging data between Synergy and on field devices - Synergy configuration based on customer needs - travel costs and labour hours to set up Synergy and on field devices 	On site cost
SYN2SCSDRV	Interface driver development for THIRD PARTY devices	Synergy support to develop the interface driver between Synergy and third party devices for a maximum of 5 measurements and feasibility study by LOVATO Electric Technical support	Cost for each driver
SYN2TRAINING	Synergy training sessions (basic and advanced courses)	Introduction to Energy Management topics. Measurement devices: range and selection criteria with case studies. Synergy software key features for monitoring and supervision architecture and access, channels, tools, graphs, data logs, pages and access criteria. Practical exercises. For further information visit EVENTS section on www.LovatoElectric.com	Confirmed

Note: every monitored device has a defined set of measures that are stored and available for a customizable period. Further information available on: <http://em.LovatoElectric.com>.

Xpress

Xpress is parameter configuration and remote monitoring software shared by the entire latest generation of LOVATO Electric products with communication port. It can be installed in the Windows environment and connected individually (one node at a time) to the LOVATO Electric products.

- Supports connection via CX01 (USB) or CX02 (Wi-Fi) device, USB, RS232, RS485, Ethernet or modem.
- Product configuration:
 - Parameter setting
 - Project file management.
- Product firmware update (via CX01)
- Remote control:
 - Monitoring of main measurements
 - Measurements graphic trends
 - Sending commands to products.
- Reading alarms and events memory
- Memory modules management EXP1030, EXM1030, EXP1031.

Consult the www.LovatoElectric.com site for the list of products supported by Xpress.

Xpress can be ordered using code SYN1XP00 or downloaded for free from: <http://www.LovatoElectric.com/xpressdownload.aspx>

● MONITORING

The measurements of the product connected are divided into context menus to make searching for the right value easy and shown on appropriate graphical gauges. It is also possible to show measurements trends.

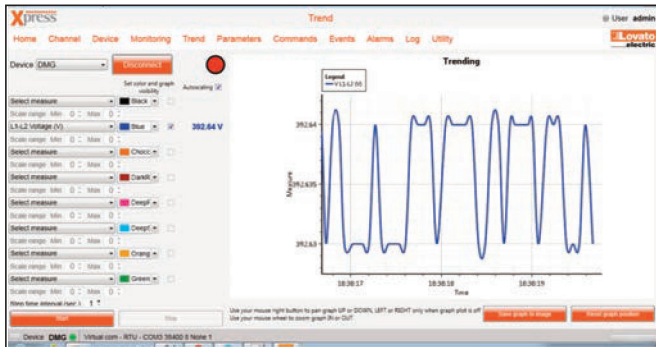

● PARAMETERS

The options in the setup menu and parameters on the product connected are replicated in the software to allow the user to operate using the terms that they already know. Parameters that differ from the factory values are highlighted in a different colour. The parameters can be saved to a file and recalled in subsequent installations, or defined even in the absence of a connection to the product, to permit preparation of a project to send later.

● EVENTS

If the product connected features an event memory, the complete list can be downloaded for saving as an external file, in text or spreadsheet format.

● DATA-LOGGER MEMORY MANAGEMENT

Xpress can be used to configure and manage the EXP1030, EXP1031 or EXM1030 memory modules, in order to create tables indicating the history of the measurements selected by the user. In particular, the software can be used to set:

- The measurements to be sampled
- The sampling time
- The event that triggers and ends sampling
- Memory capacity management (FIFO or stop when memory is full).

 The software can show the waveforms stored in EXP1031 Energy Quality module as well. The data acquired can be displayed in graphs and exported to text files or spreadsheets.

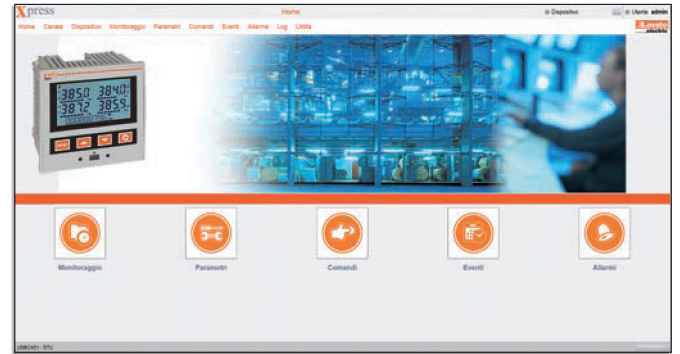

● COMMANDS

A command can be sent to the product connected to energise outputs or reset energy consumption or operating time counters for maintenance.

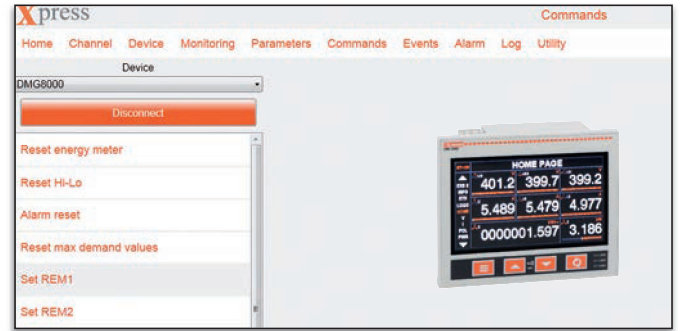

Parameter ID	Parameter Name	Value
P01.01	Language	Italiano
P01.02	Set clock at power-on	ON
P01.03	Op. Mode At Power On	OFF Mode
P01.04	Display contrast	75 %
P01.05	High backlight level	100 %
P01.06	Low backlight level	25 %

● ALARMS

The alarms active on the product connected can be displayed in the software, for a single screen with the complete list of the faults detected.



APP
Sam1



General characteristics

Configuration and maintenance operations, often done in intolerable or awkward environments due to weather or noisy conditions or narrow places, are now easier to do for all LOVATO Electric devices with communication interface on the front, compatible with CX02 device. Tablets and smartphones with Android or iOS operating systems can connect to them using the new application called **Sam1**. Therefore, it is no longer necessary to connect and switch on a PC using cables to change configurations, setup parameters etc.

With this APP, a file previously saved can be uploaded; commands can be sent; measured quantities can be read from LOVATO Electric devices. The events can be viewed and saved in a text file and later shared.

The **Sam1** App LOVATO can be downloaded from Google Play Store or App store.



Updating driver

Sending e-mail
(events, parameters)

PARAMETERS SETTING

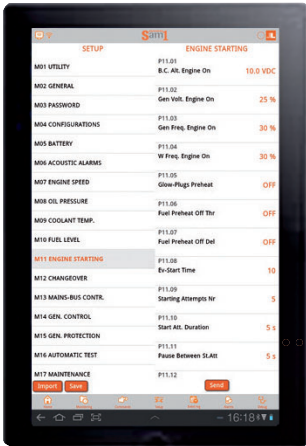

SENDING COMMANDS

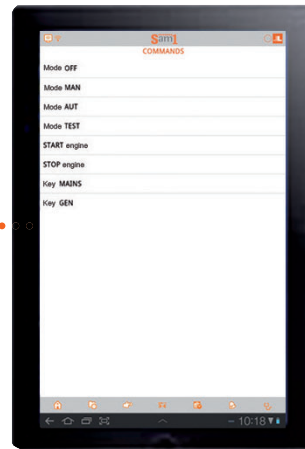

EVENT LOG VIEWING



ALARMS VIEWING



MEASUREMENTS VIEWING



APP

NFC

Updating driver



Sending e-mail (parameters)

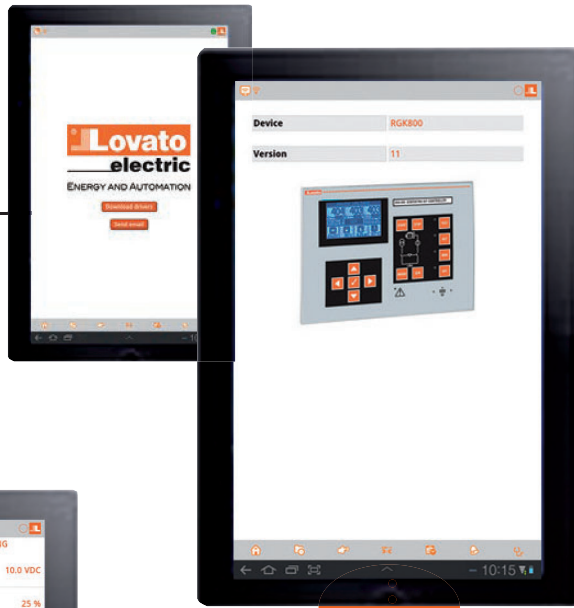

General characteristics

The parameter setting for some LOVATO Electric products is now possible via tablet and smartphone through NFC wireless technology.

Bringing the display of a smartphone or tablet (with NFC connection enabled) in close proximity to a LOVATO Electric product, activates the LOVATO NFC App and the device connected is recognised automatically.

The parameters can be set without powering up the LOVATO Electric device.

The application allows you to:

- Set the parameters for the product connected
- Save the parameters in a file and share it
- Load a parameter file saved previously
- Simple, fast and intuitive programming
- Very high accuracy and repeatability of the settings.

The app can be downloaded from Google Play Store and App Store.



PARAMETERS SETTING

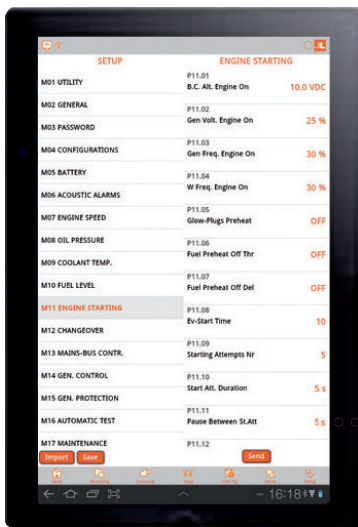

NFC



- Digital inputs and outputs
- Analog inputs and outputs
- Communication interfaces
- Data storage with clock-calendar
- Communication devices and cables to connect LOVATO Electric products to personal computers, smartphones and tablets
- Gateway data logger.

Expansion modules

	SEC.	PAGE
EXP series	31	- 2
EXM series	31	- 3

Accessories

Communication devices	31	- 4
Remote display unit	31	- 4
Converters	31	- 5
Gateway	31	- 5
Remote control and monitoring GSM modem via SMS	31	- 6
Protective cover	31	- 7
Other accessories	31	- 7
Connecting cable	31	- 7



Page 31-2

EXP SERIES EXPANSION MODULES

- For flush-mount products
- Digital inputs and outputs
- Analog inputs and outputs
- Inputs for PT100 sensors
- Communication modules (RS232, RS485, Ethernet, etc.)
- GSM/GPRS modem
- Data storage with clock-calendar (RTC)
- Powered directly by the base product
- Automatic identification by base product
- Tropicalized versions.



Page 31-3

EXM SERIES EXPANSION MODULES

- For modular products.
- Digital inputs and outputs
- Communication modules (RS232, RS485, Ethernet, etc.)
- Data storage with clock-calendar (RTC)
- Separate auxiliary power supply
- Base product connection by IR port
- Automatic identification by base product.



Page 31-4

ACCESSORIES

- Communication devices
- Remote display unit
- Converters
- Gateway
- Remote control and monitoring GSM modem via SMS
- Protective cover
- Connecting cable.

Expansion modules for flush-mount products



EXP10...

Order code	Description	Qty per pkg	Wt
		n°	[kg]
Inputs and outputs.			
EXP1000	4 digital inputs, opto-isolated	1	0.060
EXP1001	4 static outputs, opto-isolated	1	0.054
EXP1002	2 digital inputs and 2 static outputs, opto-isolated	1	0.058
EXP1003	2 relay outputs, rated 5A 250VAC	1	0.050
EXP1004 EXP1004T [ⓔ]	2 analog inputs, opto-isolated 0/4...20mA or PT100 or 0...10V or 0...±5V	1	0.056
EXP1005	2 analog outputs, opto-isolated 0/4...20mA, 0-10V or 0...±5V	1	0.064
EXP1006	2 relay outputs to increase number of steps	1	0.064
EXP1007	3 relay outputs to increase number of steps	1	0.085
EXP1008 EXP1008T [ⓔ]	2 opto-isolated digital inputs and 2 relay outputs rated 5A 250VAC	1	0.058
EXP1040	2 digital/resistive inp. 2 static out.	1	0.054
EXP1041	2 thermocouple inp. 2 static out.	1	0.054
EXP1042T [ⓔ]	6 digital inputs	1	0.054
EXP1043T [ⓔ]	4 digital inputs and 2 static outputs	1	0.054
Communication ports.			
EXP1010	Opto-isolated USB interface	1	0.060
EXP1011	Opto-isolated RS232 interface	1	0.040
EXP1012 EXP1012T [ⓔ]	Opto-isolated RS485 interface	1	0.050
EXP1013 EXP1013T [ⓔ]	Opto-isolated Ethernet interface	1	0.060
EXP1014	Opto-isolated Profibus-DP interface	1	0.080
EXP1018 [ⓔ]	IEC/EN/BS 61850 interface	1	0.060
Various functionalities.			
EXP1015	GPRS/GSM modem	1	0.080
EXP1016	Capacitor bank protection	1	0.080
EXP1030	Data storage, clock-calendar	1	0.050

ⓔ IEC/EN/BS 61850 protocol

The module will be made available only when the competent authorities have established the exact terms of the supervision and control of the specific commands (at the time of catalogue printing, currently under study as specified in the Italian CEI 0-16 and CEI 0-21 standards).

ⓔ PCB tropicalized.

General characteristics

EXP series expansion modules can increase the functionality of the LOVATO Electric products, such as:

- Digital inputs
 - Relay outputs
 - Static outputs
 - Analog inputs
 - Analog outputs
 - Inputs for PT100 temperature sensor
 - Thermocouple inputs "J" or "K" types
 - Communication interface
 - GPRS/GSM modem (without antenna, see page 31-4)
 - Data storage.
- Powered directly by the base product
 – Automatic identification by the base product
 – Rear base product mounting with no need of tools
 – **T suffixed versions have tropicalized PCB.**

Certifications and compliance

- Certifications obtained: UL Listed, for USA and Canada (cULus File E93601), as Listed Accessory under Auxiliary Devices; EXP1018 excluded, EAC.
- Compliant with standards:
- For EXP1018: IEC/EN/BS 61850 and Italian CEI 0-16, CEI 0-21
 - For EXP1004, EXP1010 and EXP1013: IEC/EN/BS 61010-1, IEC/EN/BS 61000-6-2, IEC/EN/BS 61000-6-4, UL508, CSA C22.2 n° 14
 - For EXP1015: IEC/EN/BS 61010-1, IEC/EN/BS 62311, ETSI EN 301 489-1, ETSI EN 301 469-7, EN 301 511, USA/FCC 47 CFR part 15, Subpart B, CAN/ICES-003
 - For all other types: IEC/EN/BS 61010-1, IEC/EN/BS 61000-6-2, IEC/EN/BS 61000-6-3, UL508, CSA C22.2 n° 14.

For overall dimensions, wiring diagrams and technical characteristics, consult the technical instructions in Downloads of the local or global websites; see details on inside front cover.

Expansion module fixing

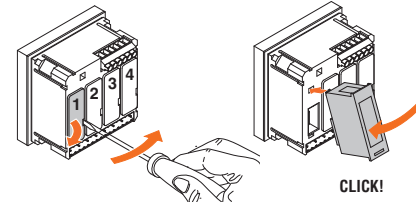

EXP series compatibility with LOVATO Electric products

TYPE	IP	DIGITAL MULTIMETERS			AUTOMATIC POWER FACTOR CONTROLLERS			AUTOMATIC TRANSFER SWITCH CONTROLLERS		FIRE PUMP CONTROLLERS		ENGINE AND GENERATOR CONTROLLERS		
	PMVF20 PMVF30	DMG 6...	DMG7000 DMG7500 DMG8000 DMG9000	DCRL3/5	DCRL8	DCRG8	ATL610	ATL800/900	FFL800...	FFLRA400	RGK4...	RGK610	RGK750 RGK8... RGK9...	
EXP1000		●	●			●	●	●		●			●	
EXP1001		●	●			●	●	●		●			●	
EXP1002		●	●			●	●	●		●			●	
EXP1003	●	●	●	●	●	●	●	●		●			●	
EXP1004...			●			●	●	●	EXP1004T				● (no RGK750)	
EXP1005			●			●	●	●					● (no RGK750)	
EXP1006				●	●	●	●	●						
EXP1007				●	●	●	●	●						
EXP1008...		●	●			●	●	●	EXP1008T	●			●	
EXP1010	●	●	●	●	●	●	●	●		●		●	●	
EXP1011	●	●	●	●	●	●	●	●		●		●	●	
EXP1012...	●	●	●	●	●	●	●	●	EXP1012T	●		●	●	
EXP1013...	●	●	●		●	●	●	●	EXP1013T	●			●	
EXP1014			●			●	●	●						
EXP1015						●	●	●	●	●			●	
EXP1016						●								
EXP1018	●													
EXP1030						●								
EXP1040												●		
EXP1041													●	
EXP1042T									●	●		●	●	
EXP1043T									●	●	●	●	●	
Max n° of	2	1	3	1	2	4	2	3	2	2	1	1	2/3/4	

Expansion modules for modular products



EXM1000



EXM1010

Order code	Description	Qty per pkg n°	Wt [kg]
Inputs and outputs.			
EXM1000	2 digital inputs and 2 static outputs, opto-isolated	1	0.137
EXM1001	2 digital inputs, opto-isolated and 2 relay outputs, rated 5A 250VAC	1	0.147
EXM1002	4 opto-isolated digital inputs and 2 relay outputs rated 5A 250VAC	1	0.155
Communication ports.			
EXM1010	Opto-isolated USB interface	1	0.140
EXM1011	Opto-isolated RS232 interface	1	0.125
EXM1012	Opto-isolated RS485 interface	1	0.140
EXM1013	Opto-isolated Ethernet interface	1	0.140
EXM1018	IEC/EN/BS 61850 interface	1	0.140
EXM1020	Opto-isolated RS485 interface and 2 relay outputs, rated 5A 250VAC	1	0.140
EXM1030	Data storage, RTC with backup reserve energy for data logging	1	0.140

IEC/EN/BS 61850 protocol

The module will be made available only when the competent authorities have established the exact terms of the supervision and control of the specific commands (at the time of catalogue printing, currently under study as specified in the Italian CEI 0-21 standard).

General characteristics

EXM series expansion modules can increase functionality of LOVATO Electric products, such as:

- Digital inputs
- Relay outputs
- Static outputs
- Communication interfaces
- Data storage.
- Connection to base product by IR (infrared beam) port
- Automatic identification by the base product
- Side base product mounting
- Auxiliary power supply: 100-240VAC 50/60Hz.

Certifications and compliance

Certifications obtained: UL Listed, for USA and Canada (cULus File E93601), as Listed Accessory under Auxiliary Devices; EXM10 18 excluded, EAC.

Compliant with standards:

- For EXM1018: IEC/EN/BS 61850 and Italian CEI 0-21
- For EXM1012, 1020, 1013: IEC/EN/BS 61010-1, IEC/EN/BS 61000-6-2, IEC/EN/BS 61000-6-4, UL 508, CSA C22.2 n° 14
- For all other types: IEC/EN/BS 61010-1, IEC/EN/BS 61000-6-2, IEC/EN/BS 61000-6-3, UL508, CSA C22.2 n° 14.

For overall dimensions, wiring diagrams and technical characteristics, consult technical instructions online in Downloads of the local or global website; see details on inside front cover.

Expansion module fixing



CLICK!

EXM series compatibility with LOVATO Electric products

	INTERFACE PRO. SYSTEM UNITS PMVF51/60/70/80	ENERGY METER DMED310T2	DATA CONCENTRATOR DMECD	DIGITAL MULTIMETER DMG300
EXM1000		●	●	●
EXM1001	●	●	●	●
EXM1002			●	●
EXM1010	●	●	●	●
EXM1011	●	●	●	●
EXM1012	●	●	●	●
EXM1013	●	●	●	●
EXM1018	●			
EXM1020		●	●	●
EXM1030		●	●	●
Max n° of modules addable	2	3	3	3

Communication devices



CX01



CX02



CX03

Order code	Description	Qty per pkg	Wt
		n°	[kg]
CX01	PC ↔ LOVATO Electric device device, with USB optic connector for programming, data download, diagnostics and firmware upgrade	1	0.090
CX02	PC ↔ LOVATO Electric device Wi-Fi device for programming, data download, diagnostics and firmware upgrade	1	0.090
CX03	GSM penta-band (850/900/1800/1900/2100MHz)	1	0.090



General characteristics

Communication devices to link LOVATO Electric products to:

- Personal computers (PC)
- Smartphones
- Tablets.

CX01

This USB/optical device, complete with cable, allows to connect compatible LOVATO Electric products with a PC without having to disconnect the power supply from the electric panel.

The PC identifies the connection as a standard USB.

CX02

This Wi-Fi point connection lets LOVATO Electric products be viewed by a PC, smartphone and tablet without having to connect cables.

CX03

Antenna compatible with major part of worldwide mobile networks, thanks to the 850/900/1800/1900/2100MHz frequencies.

IEC degree of protection: IP67. Fixing by Ø10mm/0.39" drilling. Cable length 2.5m/2.73yd.

Compliance for CX02

Compliant with standards: EN/BS 60950-1, EN 62311, EN 301 489-1 V2.2.0, EN 301 489-17 V3.2.0, EN300 328 V2.1.1.

Remote display unit



EXCRDU1

Order code	Description	Qty per pkg	Wt
		n°	[kg]
EXCRDU1	Remote display unit, graphic LCD, touchscreen 128x112 pixels, IP65 protection NEMA 4X. Compatible with ADXL... soft starter and VLB3... variable speed drives. Cable length 3m/10ft	1	0.360

General characteristics

Alarm conditions can be viewed on the remote display and alarm silencing can also be activated.

- Dual 100...240VAC / 12...24VDC power supply
- Touch screen 128x112 pixel backlight graphic LCD
- Built-in buzzer
- Static (SSR) output for global alarm signalling
- Opto-isolated RS485 interface port
- Conductor cross section: 0.2...2.5mm² (24...12 AWG; 18...12 AWG per UL/CSA)
- Tightening torque: 0.56Nm (4.5lb.in)
- Compatible with ADXL... soft starter and VLB3... variable speed drives.

Certification and compliance

Certification obtained: cULus, EAC.

Compliant with standard: IEC/EN/BS 61010-1, IEC/EN/BS 61000-6-2, IEC 61000-6-3, UL508, CSA C22.2 n° 14.

Converters



EXCCON01

Order code	Description	Qty per pkg	Wt
		n°	[kg]
EXCCON01	RS485/ Ethernet converter, 12...48VDC, including DIN rail fixing kit	1	0.400

EXCCON01 general characteristics

The EXCCON01 converter can interface "Slave" devices connected in a RS485 bus with a "Master" equipped with an Ethernet interface port:

- Kit consisting of a converter and DIN rail mounting accessory
- Web interface programming
- No power pack included.

Certifications

Certifications obtained: cULus (UL 60950-1) Listed, FCC CLASS A.

Gateway



EXCGLA01



EXCGLAX1

new

Order code	Description	Qty per pkg	Wt
		n°	[kg]
EXCGLA01	Gateway data logger for data collecting via Modbus from the device in the field. Publishing of the data to supervision software, also in Cloud	1	0.600
EXCGLAX1	2G/4G modem communication module for EXCGLA01	1	0.160
EXCM4G01	4G Gateway with RS485 and Ethernet port, Modbus RTU/TCP protocol	1	0.300

EXCGLA01 and EXCGLAX1 general characteristics

EXCGLA01 gateway is able to collect data from devices which are connected through Ethernet or RS485 port.

Modbus-RTU, ASCII and TCP protocols are supported. The data can be reviewed by a connection to Synergy Cloud service or to Ethernet local web server and a browser. The access to internet for data sending can be achieved with Ethernet port or by adding EXCGLAX1 2G/4G modem.

- CPU ARM 1 GHz
- 2 Ethernet port
- 1 RS232/RS422/RS485 serial port
- 24VDC (10...32VDC) power supply
- Operating temperature -20...+60°C
- Simplified connection to LOVATO Electric devices
- Compatible with Synergy and Synergy (4G) softwares
- Supports LTE cat. 4 Global, UMTS/DC HS DPA/HSUPA/WCDMA, GSM/GPRS/EDGE
- SIM slot for microSIM.

Compliance

Compliance with standards for EXCGLA01: EN/BS 61000-6-4 emissions,

EN/BS 61000-6-2 immunity, for installations in an industrial environment.

For EXCGLAX1: EN/BS 61000-6-4, EN/BS 61000-6-2, EN/BS 61000-6-3, EN/BS 61000-6-1, EN/BS 60945, ETSI EN 301 489-1, ETSI EN 301 489-52, EN/BS 301 511, ETSI EN 301 908-1, ETSI EN 301 908-2, EN/BS 62311, EN/BS 60950-1.

EXCM4G01 general characteristics

The EXCM4G01 gateway can interface "Slave" devices connected in a RS485 with a "Master" using a 4G network:



- Connection to TCP server through 4G or 2G network
- Operating mode either as transparent or Modbus-RTU/TCP protocol conversion from serial side to wired or mobile network
- Settable parameters: TCP server IP and remote port, network operator apn (with username and password), SIM card pin (with enabling), connection time-out, serial parameters (baud rate from 1,200 bps to 115,200 bps, stop bit, character length, parity)
- Programming via built-in web server
- 1 Ethernet port 10/100Mbps
- 1 RS485 port
- Supply 9...36VDC
- Operating temperature -40...75°C.

Compliance

Compliance with standards: EN/BS 60950-1.



EXCM4G01

			
	EXCGLA01 + EXCGLAX1	EXCM4G01	EXP1015
Transmission technology	2G/4G	2G/4G	GSM – GPRS (2G)
Connectivity with Synergy & Xpress	Yes	Yes	Yes
Device setup and supervision	Yes	Yes	Yes
Local memory	Yes	No	No
SMS and mail sending	No	No	Yes
Support for multiple devices	Yes, with RS485 or Ethernet	Yes, with RS485	No
Device compatibility	Devices with RS485 or Ethernet and modbus slave role, third party ones included	Devices with RS485 and modbus slave role, third party ones included	Only LOVATO Electric devices

Remote control and monitoring GSM modem via SMS

Compliant with Italian CEI 0-16 Standard, paragraph 8.8.6.5 and annex M, resolution 421/2014 of the ARERA



EXCGSM01

Order code	Description	Qty per pkg	Wt
		n°	[kg]
	GSM Modem (modular - 4U). IP69K outside aerial with 2.5 m cable. RJ45-USB programming cable (included).		
EXCGSM01	100...240VAC, 1 digital input, 1 analog input (0...10V, 0...20mA, NTC), 1 relay output, receiving and sending SMS messages for remote controls and alarm signals	1	0.340

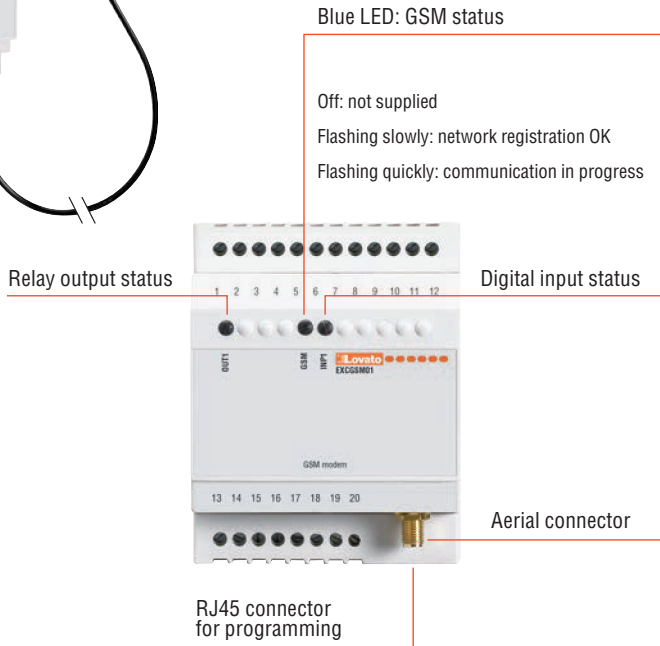

Software

To configure the EXCGSM01 modem (using the RJ45-USB programming cable included), the EXCGSMSW software must be used. This can be downloaded for free from the www.LovatoElectric.com website.

The software allows you to set:

- The users enabled to exchange messages with the modem
- The identifier of the modem, for example the active customer code (POD) in CEI 0-16 applications;
- The functions assigned to the digital output and input and to analog input;
- The texts of the SMS associated with the commands
- The logic of the actions taken following the SMS arrival, change of input status, alarm situations.

Configuration is also possible off-line, creating a file to transfer to the modem at another time.

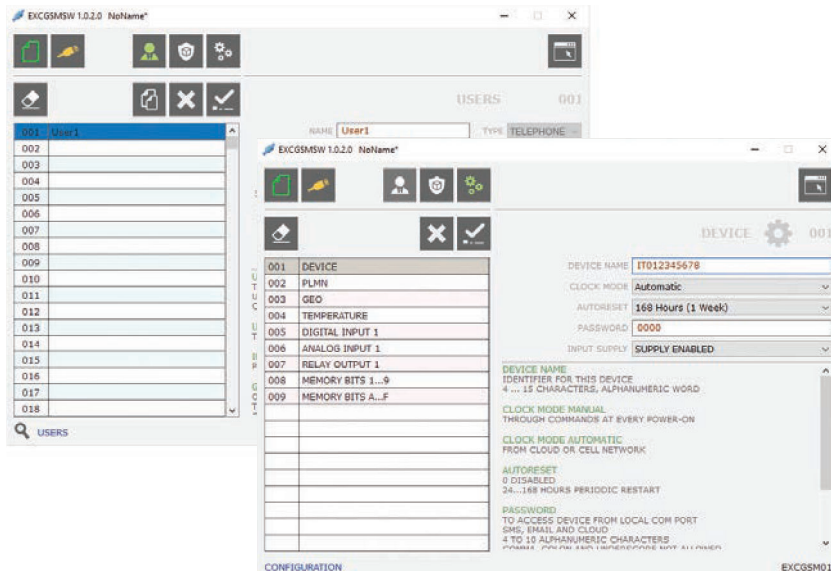

Application requirements

With EXCGSM01 it is possible to remotely operate a relay output and obtain information on the system by sending programmable SMS. Using the configuration software (available for download free of charge from www.lovatoelectric.com) the user can control the relay output and both the digital and analog inputs.

The logic is based on events (for example, the activation of the digital input or the arrival of an SMS with specific text), to which the user can decide specific actions (reply either by SMS or voice message, or by switching the relay output).

The analog input can be connected to detectors of physical measures like pressure, fluid tank level or temperature to allow remote reading of values or sending text messages via SMS or alarms.

The EXCGSM01 modem interfaces with the cellular network to regularly update its internal clock and dawn/dusk settings, so that it can manage time-scheduled events properly.

Information can be retrieved from phone network cells relative to the position of the modem (reading position information and sending alarms via SMS).

Applications:

- Detection of boiler temperature thresholds
- Fluid tank level alarms
- Time and date based load management
- Remote lighting and air conditioning system control
- Detection of moving of rental equipment.

Use with CEI 0-16

The CEI 0-16 standard in paragraph 8.8.6.5 and in attachment M prescribes that the electricity production plants powered by wind or solar photovoltaic sources with power greater than or equal to 100kW, connected or to be connected to medium voltage grids, are equipped with GSM modem.

Thanks to this modem it is possible to manage the disconnection of the generation through the messages sent by the energy distributor.

Functional characteristics

- Connection to the GSM network for sending and receiving SMS messages
 - Programmable message texts
 - Command output piloted by SMS or internal logic, for example to send the remote disconnection command to the interface switch CEI 0-16
 - Programmable digital input, for example to detect the status of the Interface switch (IS) and sending of successful IS opening and closing SMS
 - POD management (active user code)
 - Management of the list of caller IDs (CLI) up to 5000 callers enabled
 - Detection of mobile network coverage
 - Full compatibility with medium-voltage IP LOVATO Electric PMVF30: no software/hardware updates or programming required
 - **Compatibility with third-party IPs where the remote disconnection signal is transmitted via digital input (dry contact)**
- For additional information contact our Technical support
Tel. + 39 035 4282422; E-mail: service@LovatoElectric.com.

Operational characteristics

MODEM

- 35mm DIN (IEC/EN/BS 60715) rail fixing
- 4 modules
- Supply: 100...240VAC
- Consumption: 5VAC
- 1 digital output 3A 250VAC
- 1 self-supplied digital input
- 1 analog input 0...10V, 0...20mA, NTC
- Housing for 3V and 1.8V SIM card
- SIM PIN management
- Temperature sensor
- Update time, sunrise and sunset via GSM network
- Position update via GSM
- Certified according to FCC rules, part 15B
- Operating temperature: -20...+60°C
- Protection rating: IP40 on front; IP20 on terminals.

AERIAL

- Quad band 850/900/1800/1900MHz
- Degree of protection: outside IP69K
- 2.5m cable
- Fixing via M10 hole:
 - with adhesive seal
 - with threaded pin and nut.

Compliance

Compliant with electrical safety standards: EN/BS 62368, EN/BS 62311.

Protective cover



PA96X48

Order code	Description	Qty per pkg	Wt
		n°	[kg]
PA96X48	Front IP65 protective cover for multimeters DMK0/1...	1	0.048

General characteristics

If high IEC degree of protection is needed, the protective cover gives to the device the necessary protection required.

Accessories



EXP8000



EXP8001



EXP8003



EXP8004



EXM8004



DMXP03



DMXP04



NTC01

Order code	Description	Qty per pkg	Wt
		n°	[kg]
EXP8000	Plastic insert for customising label for DMG6... and DCRL3/5	10	0.005
EXP8001	IP65 gasket seal for ATL500/600/601/610 and DCRL8	1	0.009
EXP8003	35mm/1.38" DIN rail mounting accessory for ADXL0018600..., ADXL0115600 and DCTL... up to 60Kvar	1	0.200
EXP8004	Fan for ADXL... soft starter	1	0.004
EXM8004	Set of sealable terminal covers for DMG100/101/110/200/210/300	1	0.020
DMXP03	Panel mounting for 3 modules devices	1	0.052
DMXP04	Panel mounting for 4 modules devices	1	0.054
NTC01	External/remote temperature sensor, with 3m/10ft long cable	1	0.150

Connecting cable



51C2

Order code	Description	Qty per pkg	Wt
		n°	[kg]
51C2	For PC ↔ LOVATO Electric device, 1.8m/6ft long	1	0.090

General characteristics

Connecting cable to link LOVATO Electric devices with RS232 port to personal computers.

Certification

Certification obtained: EAC.