



Electric Automation
Automation specialists

Referencia: G-GRM 125 75 G
Código: 6005541

Bandeja de rejilla G-GRM, 125x75x3000,
electrozincado, DIN 50961, Acero, St

[Comprar en Electric Automation Network](#)

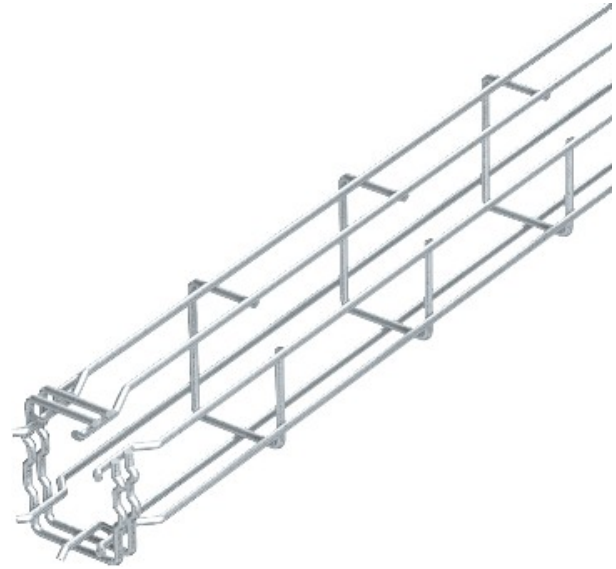

Escudo magnético de aislamiento de 15 dB.