



**Electric Automation**  
Automation specialists

Referencia: GRM 35 50 G  
Código: 6000060

Bandeja de rejilla GRM, 35x50x3000,  
electrozincado, DIN 50961, Acero, St

[Comprar en Electric Automation Network](#)

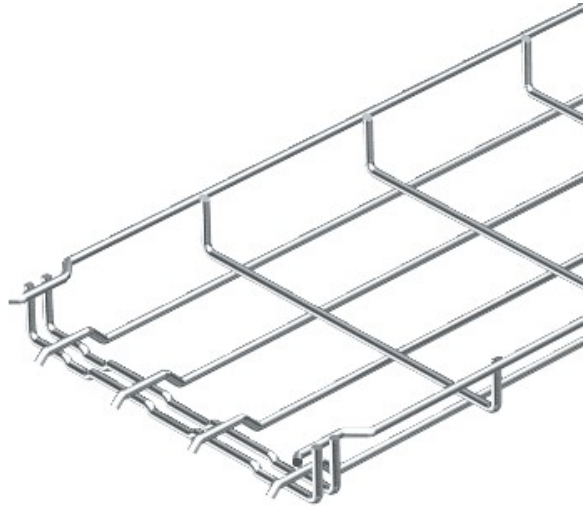

Escudo magnético de aislamiento sin cubierta de 15 dB, con cubierta de 25 dB.