



**Electric Automation**  
Automation specialists

Referência: AW 15 31 FT 2L  
Código: 6420918

Apoio e Suporte com fixação 2 buracos,  
B310mm parede, galvanizado a quente,  
DIN EN ISO 1461 Aço St

A partir de [Electric Automation Network](#)

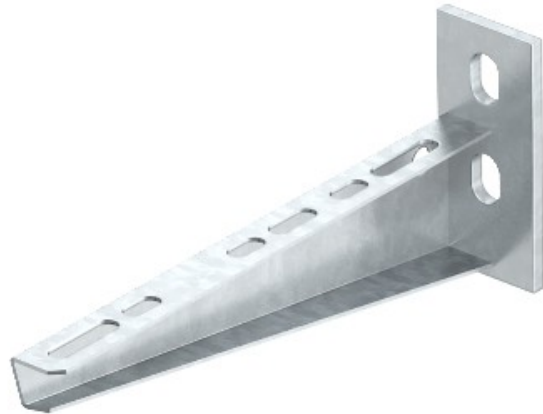

De parede e suporte de apoio com o soldado cabeça de chapa e dois furos de fixação.