



**Electric Automation**  
Automation specialists

Referência: RTM 150 FT  
Código: 6042040

pedaço T-filial com conexão rápida,  
110x500, galvanizado a quente, DIN EN  
ISO 1461 Aço St

A partir de [Electric Automation Network](#)

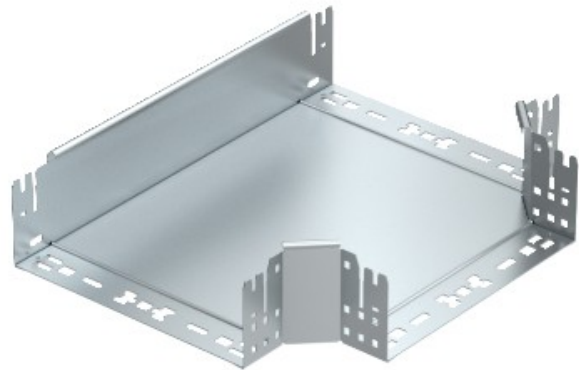

T ramo peça com conector rápido do sistema. Para todos os bandeja de cabo tipos de 110 mm de altura da lateral.