

EMCGV 40-240 LT EMV-Z

EMC Compression gland LowTemp, brass nickel-plated, M40



Products may differ in size, colour and appearance to those shown. If you require further information or customisation, please contact us directly.



Material cable gland	Brass nickel-plated
Material sealing gasket	Silicone
Temp. range min	-60 °C
Temp. range max	180 °C
Protection class	IP68 (5 bar 30 min)
Thread type	M
Ø Connection thread D	40
Lead	1,5
Length screw-in thread L	8 mm
Ø cable diameter min	22 mm
Ø cable diameter max	24 mm
Key width SW	45 mm
Collar diameter (E)	49 mm
Total length TL	24 mm - 28,5 mm
Order no. nickel-plated	10106574
Packing unit	10
Type	EMCGV 40-240 LT EMV-Z
ETIM-Classification	EC000441

Recommended accessories

EMMU-EMV 40	10063215
--------------------	----------

14.01.2021

Your Contact:

WISKA Hoppmann GmbH

Kisdorfer Weg 28 · 24568 Kaltenkirchen · Germany

☎ +49-4191-508-0 · 📠 +49-4191-508-209

contact@wiska.de · www.wiska.com

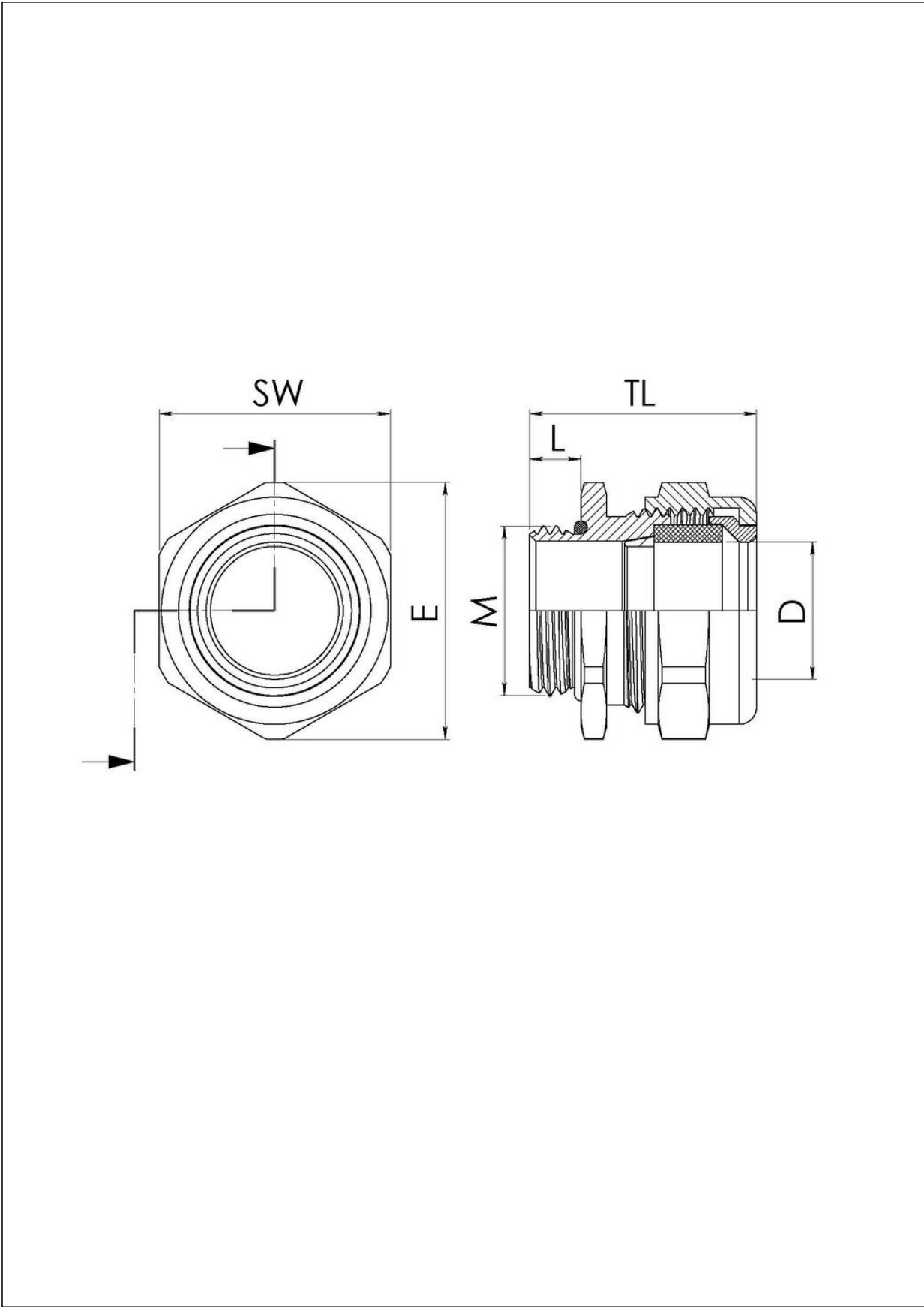

Your Contact:
WISKA Hoppmann GmbH
Kisdorfer Weg 28 · 24568 Kaltenkirchen · Germany
☎ +49-4191-508-0 · 📠 +49-4191-508-209
contact@wiska.de · www.wiska.com