

NMSKE 2

Ex-cable gland, brass nickel-plated, NPT 2"

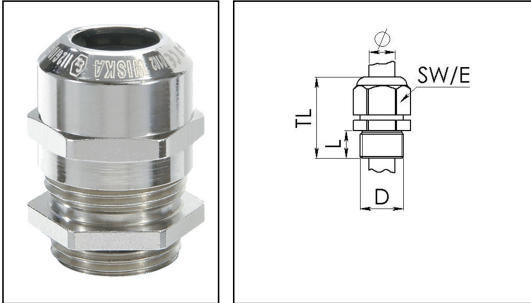

Products may differ in size, colour and appearance to those shown. If you require further information or customisation, please contact us directly.



Material cable gland	Brass nickel-plated
Material clamping cage	Polyamide
Material sealing gasket	EPDM
Temp. range min	-40 °C
Temp. range max	75 °C
Protection class	IP68 (5 bar 30 min)
Type of protection	Ex eb, Ex tb
Ex-Certificate	ATEX, IECEx
Thread type	NPT
Ø Connection thread D	2"
Length screw-in thread L	21 mm
Ø cable diameter min	34 mm
Ø cable diameter max	48 mm
Key width SW	68 mm
Collar diameter (E)	75 mm
Total length TL	56 mm - 67 mm
Install. torques fitting	40 N m
Install. torques cap nut	40 N m
Surface	Nickel-plated
Order no. nickel-plated	10101089
Type	NMSKE 2
Packing unit	10
ETIM-Classification	EC000441

Remarks:

Your Contact:

WISKA Hoppmann GmbH
Kisdorfer Weg 28 · 24568 Kaltenkirchen · Germany
☎ +49-4191-508-0 · 📠 +49-4191-508-209
contact@wiska.de · www.wiska.com

When using a locknut NMMU, an additional connection thread gasket ADR must be used to achieve protection class IP66 / IP68.

Recommended accessories

ADR 48	10061428
RDE 63	10062189
BS 48	10064019
NMMU 2	10100979

14.01.2021

Your Contact:

WISKA Hoppmann GmbH

Kisdorfer Weg 28 · 24568 Kaltenkirchen · Germany

☎ +49-4191-508-0 · 📠 +49-4191-508-209

contact@wiska.de · www.wiska.com



Your Contact:

WISKA Hoppmann GmbH

Kisdorfer Weg 28 · 24568 Kaltenkirchen · Germany

☎ +49-4191-508-0 · 📠 +49-4191-508-209

contact@wiska.de · www.wiska.com