

EMSKE 16 LT

Ex-cable gland LowTemp, brass nickel-plated with short thread, M16

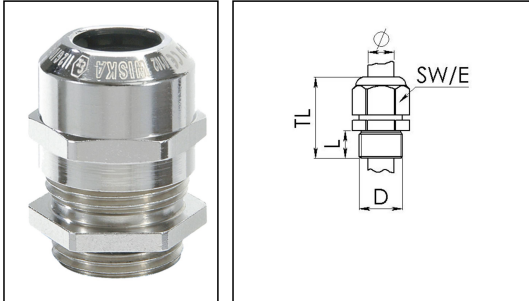

Products may differ in size, colour and appearance to those shown. If you require further information or customisation, please contact us directly.



Material cable gland	Brass nickel-plated
Material clamping cage	Polyamide
Material sealing gasket	Silicone
Temp. range min	-60 °C
Temp. range max	75 °C
Protection class	IP66 / IP68 (5 bar 30 min)
Type of protection	Ex eb, Ex tb
Ex-Certificate	ATEX, IECEx
Thread type	M
Ø Connection thread D	16
Lead	1,5
Length screw-in thread L	5 mm
Ø cable diameter min	5 mm
Ø cable diameter max	10 mm
Key width SW	20 mm
Collar diameter (E)	22 mm
Total length TL	26 mm - 34 mm
Install. torques fitting	4 N m
Install. torques cap nut	4 N m
Surface	Nickel-plated
Order no. nickel-plated	10065947
Type	EMSKE 16 LT
Packing unit	50
ETIM-Classification	EC000441

Your Contact:

WISKA Hoppmann GmbH

Kisdorfer Weg 28 · 24568 Kaltenkirchen · Germany

☎ +49-4191-508-0 · 📠 +49-4191-508-209

contact@wiska.de · www.wiska.com

Recommended accessories

EMMU 16	10063142
RDE 16 LT	10063908
BS 10	10064008

14.01.2021

Your Contact:

WISKA Hoppmann GmbH

Kisdorfer Weg 28 · 24568 Kaltenkirchen · Germany

☎ +49-4191-508-0 · 📠 +49-4191-508-209

contact@wiska.de · www.wiska.com



Your Contact:

WISKA Hoppmann GmbH

Kisdorfer Weg 28 · 24568 Kaltenkirchen · Germany

☎ +49-4191-508-0 · 📠 +49-4191-508-209

contact@wiska.de · www.wiska.com