

ESSKE-4 50 LT EMV-Z

Ex-EMC Cable gland LowTemp, stainless steel 1.4404, M50

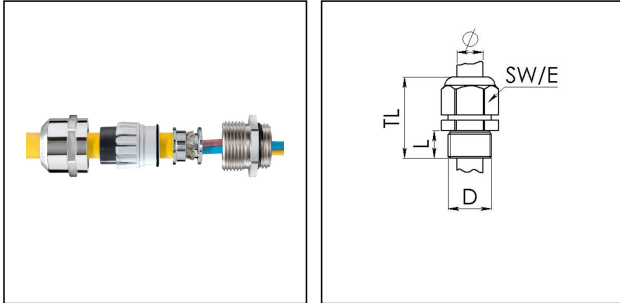

Products may differ in size, colour and appearance to those shown. If you require further information or customisation, please contact us directly.



Material cable gland	Stainless steel A4 (1.4404)
Material clamping cage	Polyamide
Material sealing gasket	Silicone
Temp. range min	-60 °C
Temp. range max	75 °C
Protection class	IP66, IP68 (5 bar 30 min)
Type of protection	Ex eb, Ex tb
Ex-Certificate	IECEX, ATEX
Thread type	M
Ø Connection thread D	50
Lead	1,5
Length screw-in thread L	9 mm
Ø cable diameter min	21 mm
Ø cable diameter max	35 mm
Ø cable below cable shield	33 mm
Key width SW	55 mm
Collar diameter (E)	61 mm
Total length TL	51 mm - 62 mm
Install. torques fitting	30 N m
Install. torques cap nut	30 N m
WISKA-Order no.	10065364
Type	ESSKE-4 50 LT EMV-Z
Packing unit	2
ETIM-Classification	EC000441

Your Contact:

WISKA Hoppmann GmbH

Kisdorfer Weg 28 · 24568 Kaltenkirchen · Germany

☎ +49-4191-508-0 · 📠 +49-4191-508-209

contact@wiska.de · www.wiska.com

Recommended accessories

RDE 50 LT	10063966
BS 35	10064017
ESMU 50	10064194

14.01.2021

Your Contact:

WISKA Hoppmann GmbH

Kisdorfer Weg 28 · 24568 Kaltenkirchen · Germany

☎ +49-4191-508-0 · 📠 +49-4191-508-209

contact@wiska.de · www.wiska.com



Your Contact:
WISKA Hoppmann GmbH
Kisdorfer Weg 28 · 24568 Kaltenkirchen · Germany
☎ +49-4191-508-0 · 📠 +49-4191-508-209
contact@wiska.de · www.wiska.com