

EMSKE 32

Ex-cable gland, brass nickel-plated with short thread, M32

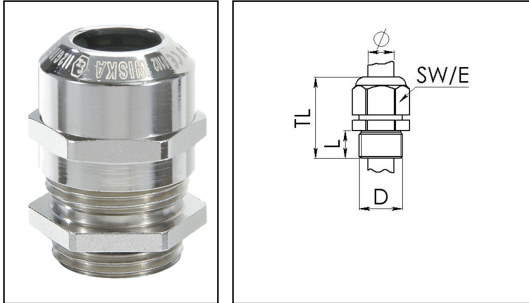

Products may differ in size, colour and appearance to those shown. If you require further information or customisation, please contact us directly.



Material cable gland	Brass nickel-plated
Material clamping cage	Polyamide
Material sealing gasket	EPDM
Temp. range min	-40 °C
Temp. range max	75 °C
Protection class	IP66 / IP68 (5 bar 30 min)
Type of protection	Ex eb, Ex tb
Ex-Certificate	ATEX, IECEx
Thread type	M
Ø Connection thread D	32
Lead	1,5
Length screw-in thread L	8 mm
Ø cable diameter min	13 mm
Ø cable diameter max	21 mm
Ø cable diameter UL	14,6 mm - 19,5 mm
Key width SW	36 mm
Collar diameter (E)	40 mm
Total length TL	36 mm - 44 mm
Install. torques fitting	20 N m
Install. torques cap nut	20 N m
Surface	Nickel-plated
Order no. nickel-plated	10065044
Type	EMSKE 32
Packing unit	25
ETIM-Classification	EC000441

Your Contact:

WISKA Hoppmann GmbH

Kisdorfer Weg 28 · 24568 Kaltenkirchen · Germany

☎ +49-4191-508-0 · 📠 +49-4191-508-209

contact@wiska.de · www.wiska.com

Recommended accessories

RDE 32	10062186
EMMU 32	10063145
BS 21	10064014

14.01.2021

Your Contact:

WISKA Hoppmann GmbH

Kisdorfer Weg 28 · 24568 Kaltenkirchen · Germany

☎ +49-4191-508-0 · 📠 +49-4191-508-209

contact@wiska.de · www.wiska.com



Your Contact:

WISKA Hoppmann GmbH

Kisdorfer Weg 28 · 24568 Kaltenkirchen · Germany

☎ +49-4191-508-0 · 📠 +49-4191-508-209

contact@wiska.de · www.wiska.com