

inserto piatto per pulsante luminoso, rotondo, opalescente con scritta nera. con simbolo grafico Pompa refrigerante



marca del prodotto	SIRIUS ACT
denominazione del prodotto	Inserto piatto
designazione del tipo di prodotto	3SU1





Dati tecnici generali

Resistenza agli urti <ul style="list-style-type: none"> per applicazioni ferroviarie secondo EN 61373 	categoria 1, classe B
Resistenza a vibrazioni <ul style="list-style-type: none"> per applicazioni ferroviarie secondo EN 61373 	categoria 1, classe B

Accessori

Materiale degli accessori	plastica
Tipo di fissaggio della targhetta	inserire
Marcatura dell'inserto piatto	SIMBOLO: POMPA REFRIGERANTE
Forma dell'inserto piatto	rotondo
Colore dell'inserto piatto	opalescente/nero (targhetta/iscrizione)
Simboli ISO stampati	SIMBOLO: POMPA REFRIGERANTE

Certificati/ Approvazioni

General Product Approval			Declaration of Conformity	Test Certificates
 CSA	 UL		 EG-Konf.	Miscellaneous Type Test Certificates/Test Report

Marine / Shipping					other
 ABS	 LRS	 PRS	 RINA	 RMRS	Confirmation

Ulteriori informazioni

Information- and Downloadcenter (Cataloghi, Opuscoli,...)

<https://www.siemens.com/ic10>

Industry Mall (sistema di ordinazione Online)

<https://mall.industry.siemens.com/mall/it/it/Catalog/product?mlfb=3SU1900-0AB71-0RE0>

Generatore CAx online

<http://support.automation.siemens.com/WW/CAXorder/default.aspx?lang=en&mlfb=3SU1900-0AB71-0RE0>

Service&Support (Manuali, Certificati, Caratteristiche, FAQ, ...)

<https://support.industry.siemens.com/cs/ww/it/ps/3SU1900-0AB71-0RE0>

Banca dati immagini (foto prodotto, disegni dimensionali 2D, modelli 3D, schemi delle connessioni, macro EPLAN...)

http://www.automation.siemens.com/bilddb/cax_de.aspx?mlfb=3SU1900-0AB71-0RE0&lang=en

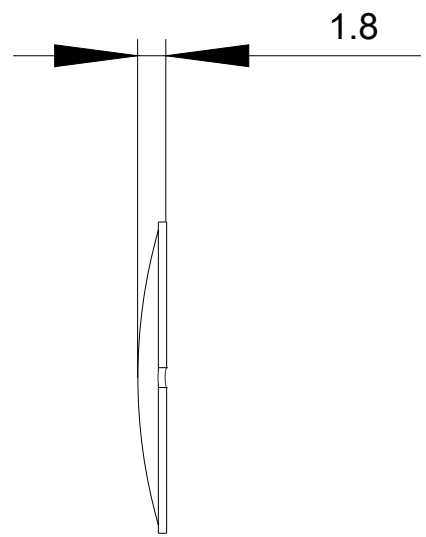
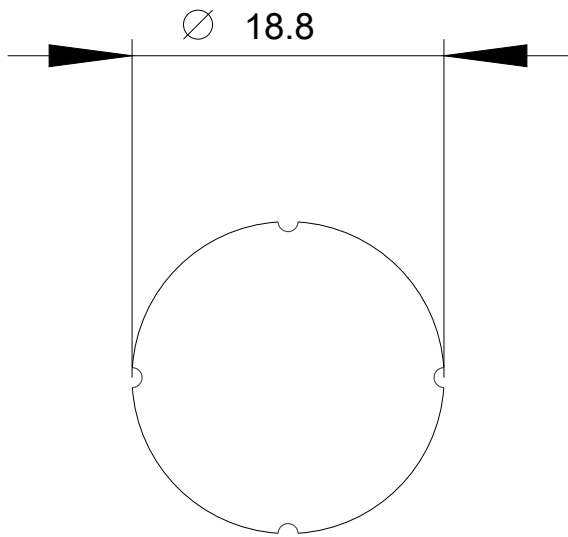

Ultima modifica:

06/08/2020