

Borne support, vert/jaune, borne à vis, pour fixation sur plaque frontale

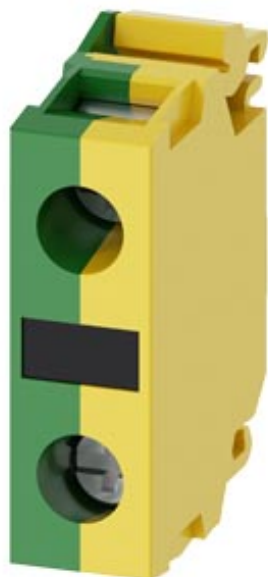

nom de marque produit	SIRIUS ACT
désignation du produit	Borne support
désignation type de produit	3SU1

Caractéristiques techniques générales

Compatibilité d'intégration	Oui
Degré de pollution	3
Tension de tenue aux chocs Valeur assignée	6 kV
<ul style="list-style-type: none"> Indice de protection IP du boîtier Indice de protection IP de la borne de raccordement 	IP40 IP20
désignation du matériel selon CEI 81346-2:2009	S
désignation du matériel selon EN 61346-2	S

Raccordements/ Bornes

<ul style="list-style-type: none"> type du raccordement électrique Type du raccordement électrique des modules et accessoires 	raccordement à vis Bornes à vis
---	------------------------------------

Conditions ambiantes

<ul style="list-style-type: none"> température ambiante en service 	-25 ... +70 °C
---	----------------





• Température ambiante à l'entreposage

-40 ... +80 °C

Montage/ fixation/ dimensions

Mode de fixation	
• des modules et accessoires	Fixation sur panneau de commande
hauteur	33,2 mm
largeur	9,8 mm
profondeur	23,4 mm

Certificats/ homologations

General Product Approval	Declaration of Conformity	Test Certificates	Marine / Shipping
 UL	 EAC	 EG-Konf.	 ABS

[Miscellaneous](#)

[Type Test Certificates/Test Report](#)

Marine / Shipping

other



LRS



PRS



RINA



RMRS

[Confirmation](#)

Autres informations

Information- and Downloadcenter (Catalogues, Brochures,...)

<https://www.siemens.com/ic10>

Industry Mall (système de commande en ligne)

<https://mall.industry.siemens.com/mall/fr/fr/Catalog/product?mlfb=3SU1400-1DA43-1AA0>

Générateur CAx en ligne

<http://support.automation.siemens.com/WW/CAxorder/default.aspx?lang=en&mlfb=3SU1400-1DA43-1AA0>

Service&Support (manuels, certificats, caractéristiques, questions fréquentes FAQ, etc.)

<https://support.industry.siemens.com/cs/ww/fr/ps/3SU1400-1DA43-1AA0>

Banque de données images (photos des produits, schémas cotés 2D, modèles 3D, schémas des connexions, macros

EPLAN, ...)

http://www.automation.siemens.com/bilddb/cax_de.aspx?mlfb=3SU1400-1DA43-1AA0&lang=en

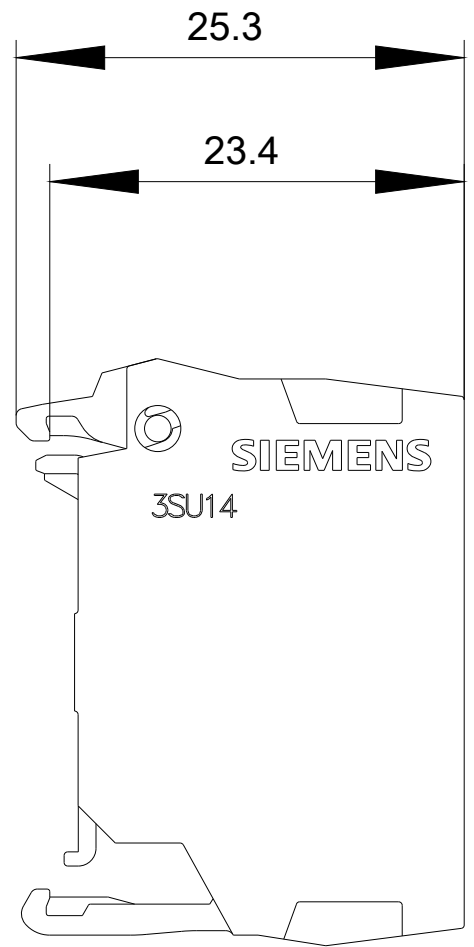
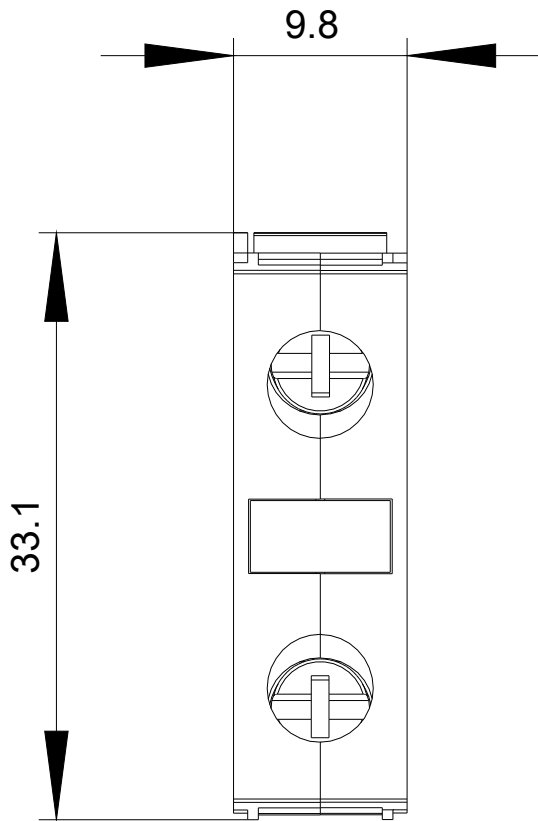

dernière modification :

19-08-2020