

mando giratorio frontal estándar IEC IP30/40 Accesorio para: 3VA1  
100/160







## La versión

Nombre comercial del producto	SETRON
Designación del producto	Accesorios
Tipo de producto	Accionamiento giratorio frontal

## Diseño Mecánico

Altura	70 mm
Anchura	77 mm
Profundidad	95 mm
Peso neto	203 g

## Certificados

General Product Approval	EMC	Declaration of Conformity	Test Certificates
 VDE	<a href="#">Miscellaneous</a> 	 RCM	 EG-Konf.
			<a href="#">Type Test Certificates/Test Report</a>

Shipping Approval	other		
 LRS	<a href="#">Manufacturer Declaration</a>	<a href="#">Miscellaneous</a>	

## Más información

### Information- and Downloadcenter (Catálogos, Folletos,...)

<http://www.siemens.com/lowvoltage/catalogs>

### Industry Mall (sistema de pedido online)

<https://eb.automation.siemens.com/mall/es/WW/Catalog/Product/3VA9157-0EK11>

### Service&Support (Manuales, certificados, características, FAQ,...)

<http://support.automation.siemens.com/WW/view/es/3VA9157-0EK11/all>

### Base de datos de imágenes (fotos de producto, dibujos acotados 2D, modelos 3D, esquemas de conexiones, ...)

[http://www.automation.siemens.com/bilddb/cax\\_en.aspx?mfb=3VA9157-0EK11](http://www.automation.siemens.com/bilddb/cax_en.aspx?mfb=3VA9157-0EK11)

### CAX-Online-Generator

<http://www.siemens.com/cax>

### Tender specifications

<http://www.siemens.com/specifications>

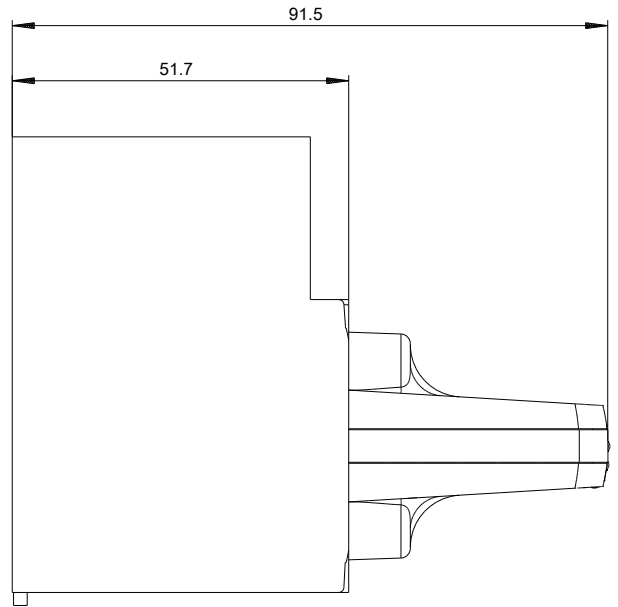
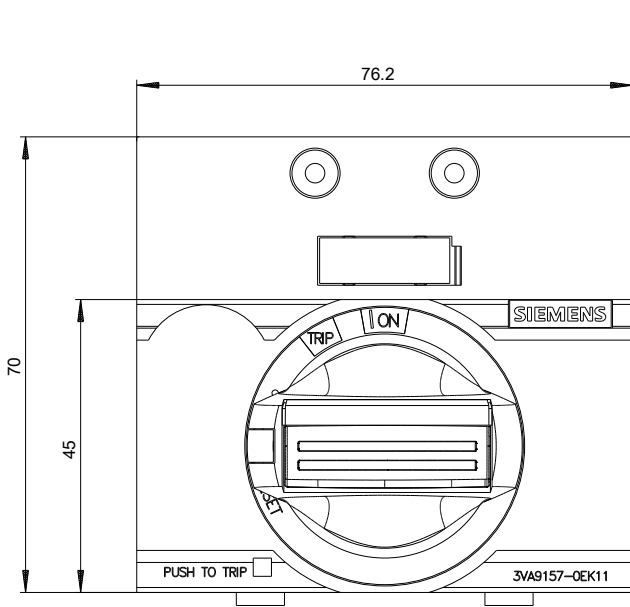

Última modificación:

31/07/2020