







Collar de protección para pulsador de seta de Parada de emergencia, con o sin cerradura Ronis, diseño de 22 mm, amarillo, material plástico



Nombre comercial del producto	SIRIUS ACT
Designación del producto	Collar de protección
Tipo de producto	para pulsador de seta de parada de emergencia sin cerradura o con cerradura RONIS
Denominación del tipo de producto	3SU1
Datos técnicos generales	
Grado de protección IP	IP66, IP67, IP69(IP69K)
Grado de protección NEMA	1, 2, 3, 3R, 4, 4X, 12
Instalación/ fijación/ dimensiones	
Altura	58,9 mm
Anchura	74,8 mm
Profundidad	47,5 mm
Accesorios	
Material del accesorio	Plástico
Color del accesorio	amarillo
Certificados/ Homologaciones	

General Product Approval		Declaration of Conformity		Test Certificates
 CSA	 UL		 EG-Konf.	Miscellaneous Type Test Certificates/Test Report

Marine / Shipping					other
 ABS	 LRS	 PRS	 RINA	 RMRS	Confirmation

Más información

Information- and Downloadcenter (Catálogos, Folletos,...)

<https://www.siemens.com/ic10>

Industry Mall (sistema de pedido online)

<https://mall.industry.siemens.com/mall/es/es/Catalog/product?mlfb=3SU1900-0DY30-0AA0>

Generador CAx online

<http://support.automation.siemens.com/WW/CAxorder/default.aspx?lang=en&mlfb=3SU1900-0DY30-0AA0>

Service&Support (Manuales, certificados, características, FAQ,...)

<https://support.industry.siemens.com/cs/ww/es/ps/3SU1900-0DY30-0AA0>

Base de datos de imágenes (fotos de producto, dibujos acotados 2D, modelos 3D, esquemas de conexiones, macros

EPLAN, ...)

http://www.automation.siemens.com/bilddb/cax_de.aspx?mlfb=3SU1900-0DY30-0AA0&lang=en

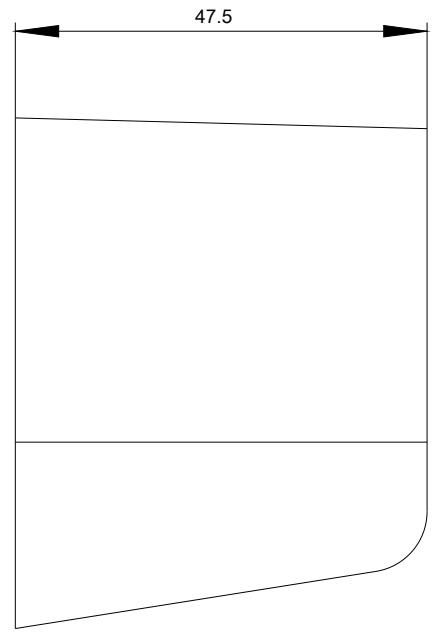
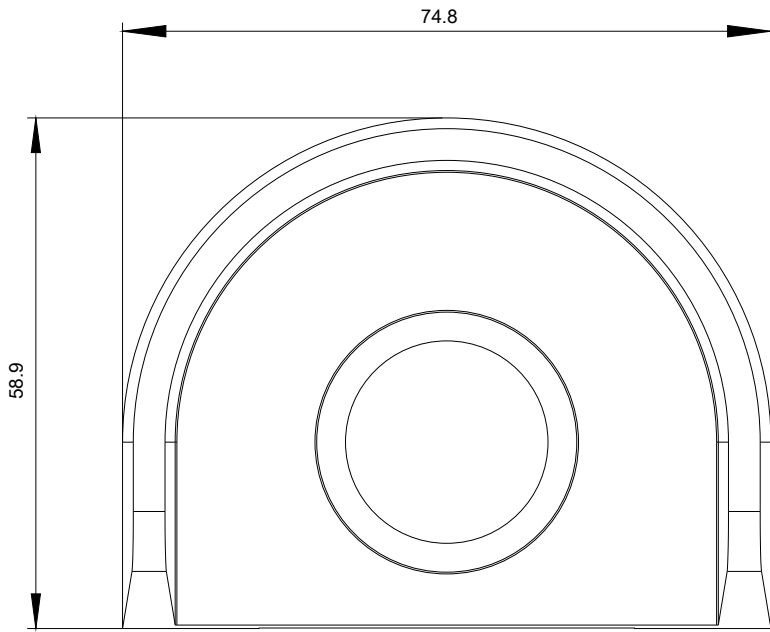

Última modificación:

09/07/2020