

Placa insertable para pulsador luminoso, redondo, opaco con fuente negra, con rotulación: Auf



Nombre comercial del producto	SIRIUS ACT
Designación del producto	Plaquita interior
Denominación del tipo de producto	3SU1





Datos técnicos generales





Resistencia a choques <ul style="list-style-type: none">para aplicaciones ferroviarias según EN 61373	categoria 1, clase B
Resistencia a vibraciones <ul style="list-style-type: none">para aplicaciones ferroviarias según EN 61373	categoria 1, clase B

Accesorios

Material del accesorio	Plástico
Tipo de fijación de la plaquita	insertar
Identificación de la plaquita insertable	Auf
Forma de la plaquita insertable	redondo
Color de la plaquita insertable	opalino/negro (placa/inscripción)

Certificados/ Homologaciones

General Product Approval		Declaration of Conformity		Test Certificates
 CSA	 UL		 EG-Konf.	Miscellaneous Type Test Certificates/Test Report

Marine / Shipping					other
 ABS	 LRS	 PRS	 RINA	 RMRS	Confirmation

Más información

Information- and Downloadcenter (Catálogos, Folletos,...)

<https://www.siemens.com/ic10>

Industry Mall (sistema de pedido online)

<https://mall.industry.siemens.com/mall/es/es/Catalog/product?mlfb=3SU1900-0AB71-0AD0>

Generador CAx online

<http://support.automation.siemens.com/WW/CAxorder/default.aspx?lang=en&mlfb=3SU1900-0AB71-0AD0>

Service&Support (Manuales, certificados, características, FAQ,...)

<https://support.industry.siemens.com/cs/ww/es/ps/3SU1900-0AB71-0AD0>

Base de datos de imágenes (fotos de producto, dibujos acotados 2D, modelos 3D, esquemas de conexiones, macros EPLAN, ...)

http://www.automation.siemens.com/bilddb/cax_de.aspx?mlfb=3SU1900-0AB71-0AD0&lang=en

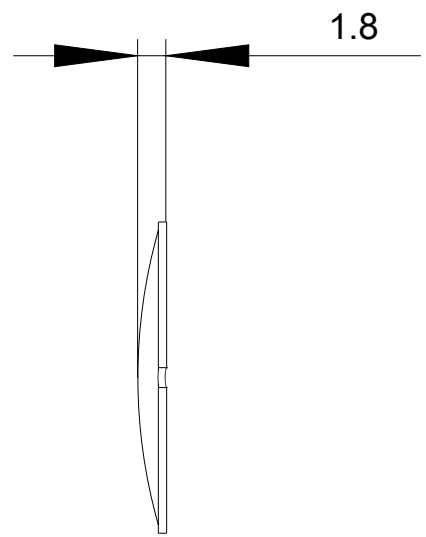
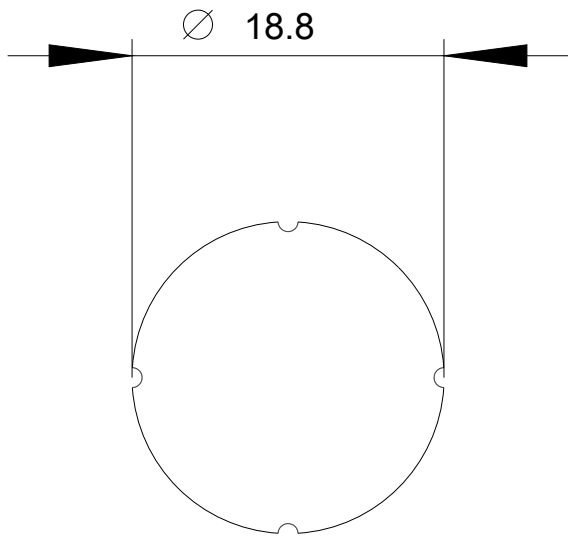

Última modificación:

30/07/2020