









Bobina extraíble para 3RT105.-X.-0LA2 o 3RT145.-X.-0LA2 72 V DC
 ×(0,7-1,25) tensión de alimentación entrada PLC 24...110 V DC borne de resorte

Certificados/ Homologaciones

General Product Approval		EMC	Declaration of Conformity		
	Confirmation				
				UK Declaration of Conformity	
Declaration of Conformity	Test Certificates		Marine / Shipping		
	Type Test Certificates/Test Report	Special Test Certificate			
Marine / Shipping	other	Railway			
	Confirmation	Miscellaneous	Special Test Certificate		

Más información

Information- and Downloadcenter (Catálogos, Folletos,...)

<https://www.siemens.com/ic10>

Industry Mall (sistema de pedido online)

<https://mall.industry.siemens.com/mall/es/es/Catalog/product?mlfb=3RT1955-5XJ42>

Generador CAX online

<http://support.automation.siemens.com/WW/CAXorder/default.aspx?lang=en&mlfb=3RT1955-5XJ42>

Service&Support (Manuales, certificados, características, FAQ,...)

<https://support.industry.siemens.com/cs/ww/es/ps/3RT1955-5XJ42>

Base de datos de imágenes (fotos de producto, dibujos acotados 2D, modelos 3D, esquemas de conexiones, macros EPLAN, ...)

http://www.automation.siemens.com/bilddb/cax_de.aspx?mlfb=3RT1955-5XJ42&lang=en

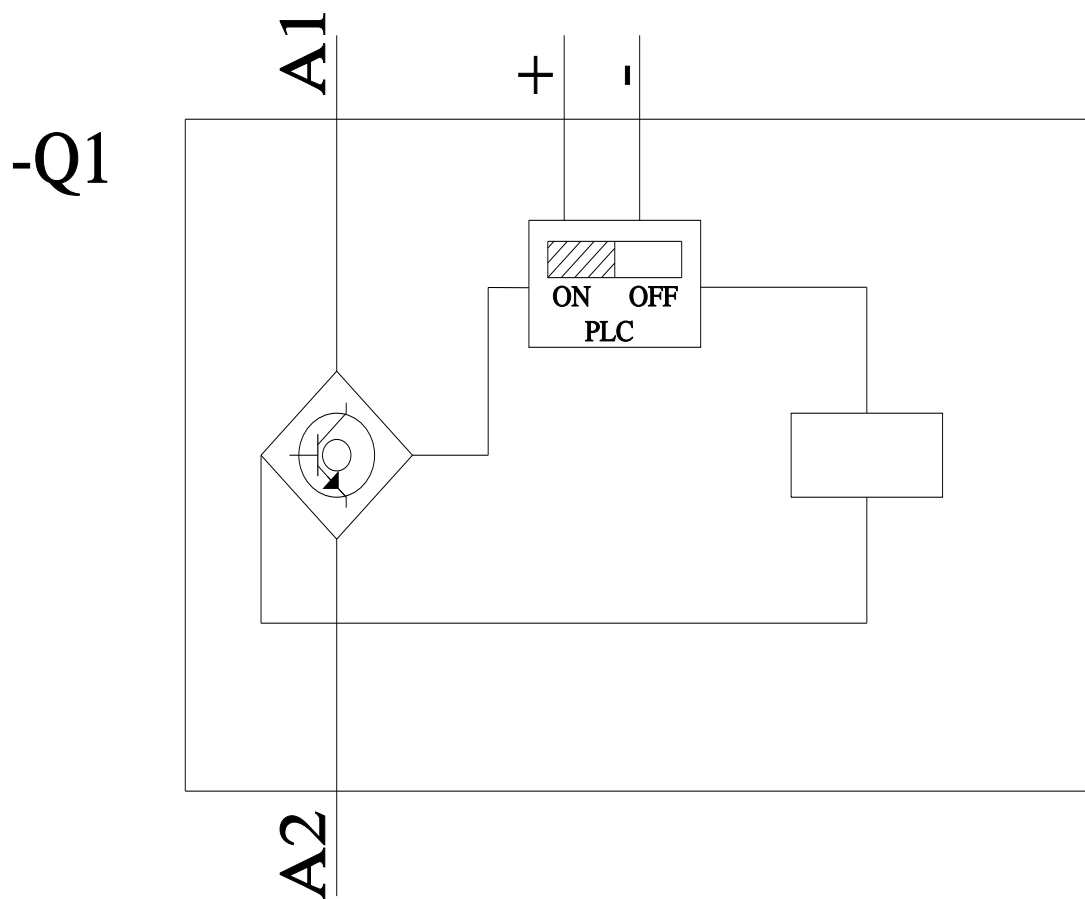

Última modificación:

18/1/2021 