

Módulo adosable AS-i para desconexión segura
 Conexión circuito de mando: borne de tornillo

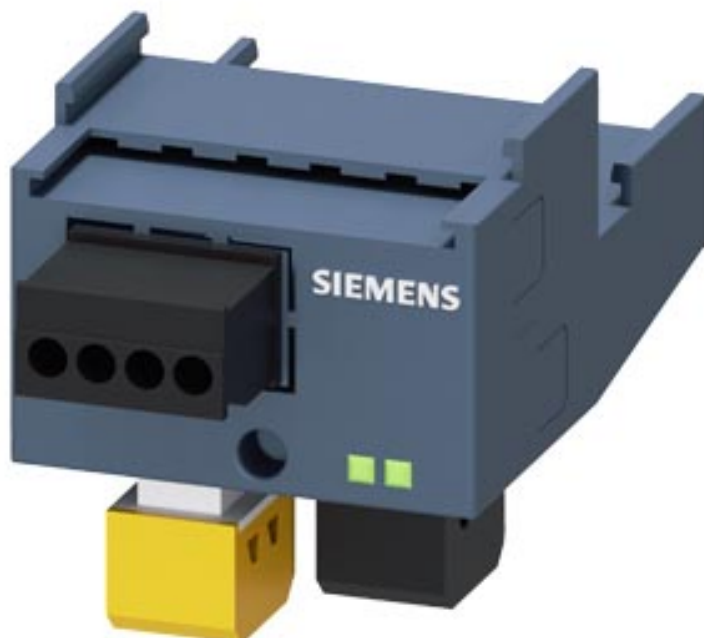











Datos técnicos generales		
Nombre comercial del producto		SIRIUS
Designación del producto		módulo adosable AS-i para desconexión segura
Grado de protección IP		IP20
humedad relativa del aire durante el funcionamiento	%	10 ... 90
Temperatura ambiente		
• durante el transporte	°C	-25 ... +70
• durante el almacenamiento	°C	-25 ... +80
• durante el funcionamiento	°C	-20 ... +60
Designaciones de referencia según EN 61346-2		K
Designaciones de referencia según DIN 40719, ampliado según IEC 204-2 según IEC 750		K
Instalación/ fijación/ dimensiones		
Anchura	mm	45
Altura	mm	50
Profundidad	mm	78
Conexiones/ Bornes		
Longitud a pelar	mm	7

Tipo de conexión eléctrica		conexión por tornillo
<ul style="list-style-type: none"> para circuito auxiliar y circuito de mando 		
Par de apriete para contactos auxiliares con bornes de tornillo	N·m	0,5 ... 0,6

Certificados/ Homologaciones

Certificado de aptitud	IEC / EN 60947-6-2
-------------------------------	--------------------

General Product Approval	EMC	Declaration of Conformity
 CSA  UL  EAC  RCM  EG-Konf.		Miscellaneous

Shipping Approval	other
 ABS  BUREAU VERITAS  LRS  PRS  RMRS  ASi	

other
Confirmation

Más información

Information- and Downloadcenter (Catálogos, Folletos,...)

<https://www.siemens.com/ic10>

Industry Mall (sistema de pedido online)

<https://mall.industry.siemens.com/mall/es/es/Catalog/product?mlfb=3RA6970-3B>

Generador CAx online

<http://support.automation.siemens.com/WW/CAXorder/default.aspx?lang=en&mlfb=3RA6970-3B>

Service&Support (Manuales, certificados, características, FAQ,...)

<https://support.industry.siemens.com/cs/ww/es/ps/3RA6970-3B>

Base de datos de imágenes (fotos de producto, dibujos acotados 2D, modelos 3D, esquemas de conexiones, macros

EPLAN, ...)

http://www.automation.siemens.com/bilddb/cax_de.aspx?mlfb=3RA6970-3B&lang=en

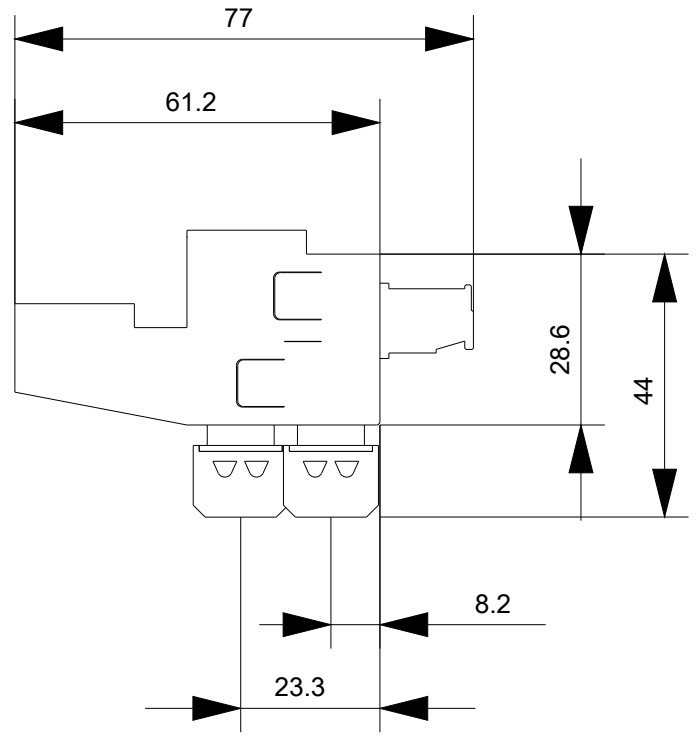
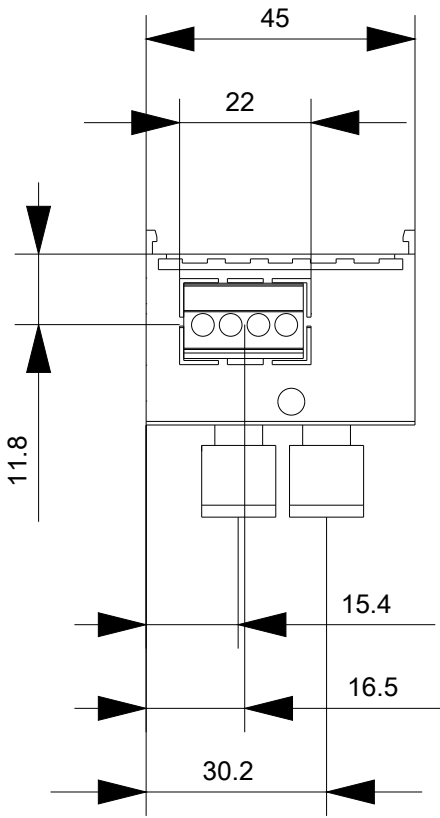

Última modificación:

27/06/2020