

Inscription plate for illuminated pushbutton, round, milky with black font, with graphic symbol: lock

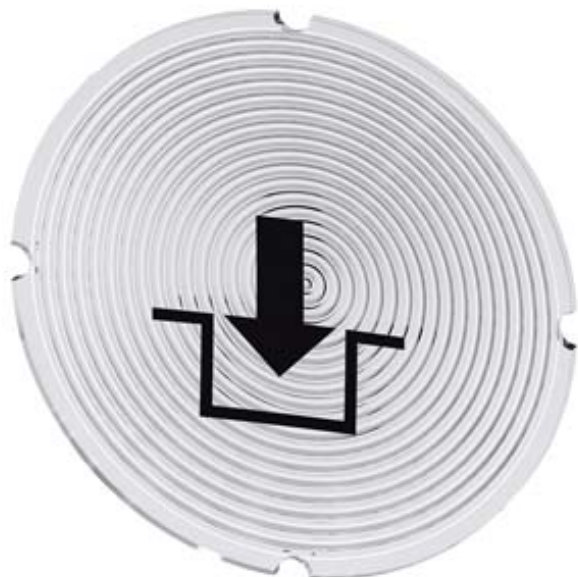

Product brand name	SIRIUS ACT
Product designation	Insert label
Product type designation	3SU1





General technical data

Shock resistance	
<ul style="list-style-type: none"> for railway applications acc. to DIN EN 61373 	Category 1, Class B
Vibration resistance	
<ul style="list-style-type: none"> for railway applications acc. to DIN EN 61373 	Category 1, Class B

Accessories

Material of accessory	Plastic
Mounting type of label	insert
Marking of inscription plate	SYMBOL: LOCK
Shape of inscription plate	Round
Color of inscription plate	milky/black (label/lettering)
Printed ISO symbols	SYMBOL: LOCK

Certificates/ approvals

General Product Approval			Declaration of Conformity	Test Certificates
 CSA	 UL		 EG-Konf.	Miscellaneous Type Test Certificates/Test Report

Marine / Shipping					other
 ABS	 LRS	 PRS	 RINA	 RMRS	Confirmation

Further information

Information- and Downloadcenter (Catalogs, Brochures,...)

<https://www.siemens.com/ic10>

Industry Mall (Online ordering system)

<https://mall.industry.siemens.com/mall/en/en/Catalog/product?mlfb=3SU1900-0AB71-0RK0>

Cax online generator

<http://support.automation.siemens.com/WW/CAXorder/default.aspx?lang=en&mlfb=3SU1900-0AB71-0RK0>

Service&Support (Manuals, Certificates, Characteristics, FAQs,...)

<https://support.industry.siemens.com/cs/ww/en/ps/3SU1900-0AB71-0RK0>

Image database (product images, 2D dimension drawings, 3D models, device circuit diagrams, EPLAN macros, ...)

http://www.automation.siemens.com/bilddb/cax_de.aspx?mlfb=3SU1900-0AB71-0RK0&lang=en

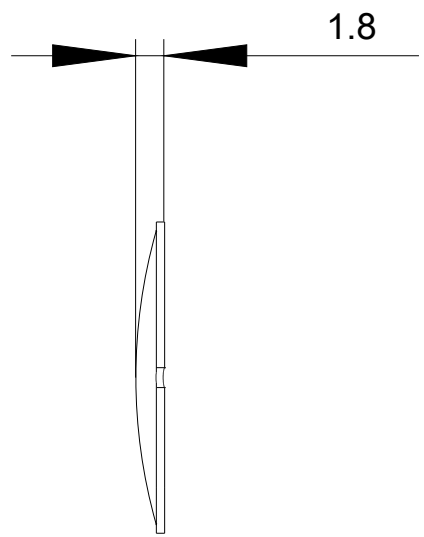
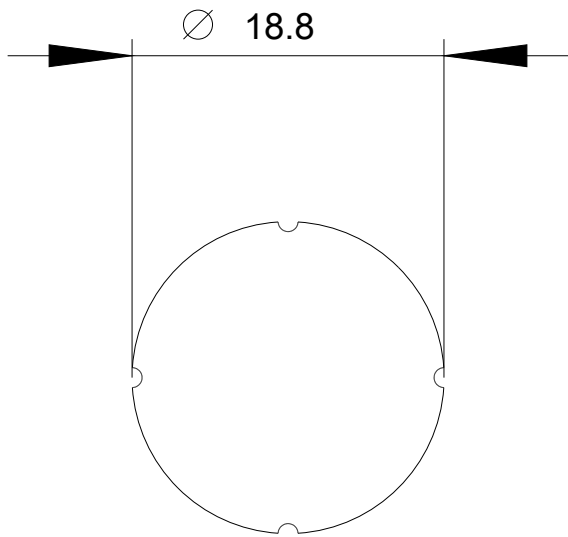

last modified:

08/06/2020