

Hinge switch Molded-plastic enclosure with aluminum hinge 3xNC, Slow-action contacts for 40 mm profiles Supplied with additional hinge and fixing material Cable entry 2 x M20 x 1.5 Actuating angle 8°



Product brand name	SIRIUS
Suitability for use safety switch	Yes

General technical data

Product function	
• positive opening	Yes
Insulation voltage	
• rated value	250 V
Surge voltage resistance rated value	4 kV
Protection class IP	IP65
Shock resistance	30g / 18 ms
Vibration resistance	10 ... 200 Hz: 20g
Mechanical service life (switching cycles)	
• typical	1 000 000
Thermal current	2.5 A
Reference code acc. to DIN EN 81346-2	B
Reference code acc. to DIN EN 61346-2	B
Active principle	mechanical
Length of the sensor	92 mm
Width of the sensor	111.5 mm

Design of the switching contact	mechanical
Number of NC contacts for auxiliary contacts	3
Number of NO contacts for auxiliary contacts	0
Operating current at AC-15	
• at 125 V rated value	4.2 A
• at 230 V rated value	2 A
Operating current at DC-13	
• at 24 V rated value	1 A
Design of the interface for safety-related communication	without

Enclosure

Design of the housing	special design
Material of the enclosure	glass fiber reinforced thermoplast
Coating of the enclosure	none
Design of the housing acc. to standard	No

Drive Head

Design of the operating mechanism	rotary actuator
Design of the switching function	positive opening
Circuit principle	slow-action contacts
Number of switching contacts safety-related	3

Connections/ Terminals

Type of electrical connection	screw-type terminals
Type of connectable conductor cross-sections	
• finely stranded with core end processing	1x (0,5 ... 1 mm ²)
Cable entry type	2 x (M20 x 1.5)

Communication/ Protocol

Design of the interface	without
--------------------------------	---------





Ambient conditions

Ambient temperature	
• during operation	-25 ... +65 °C
Explosion protection category for dust	none

Installation/ mounting/ dimensions





Mounting type	screw fixing
----------------------	--------------

Certificates/ approvals

General Product Approval	Declaration of Conformity	Test Certificates	Marine / Shipping
 UL	 EAC	 EG-Konf.	 ABS

[Miscellaneous](#)

[Miscellaneous](#)

Marine / Shipping	other
 LRS  PRS  RINA  DNV-GL DNVGL.COM/AF	Confirmation

Further information

Information- and Downloadcenter (Catalogs, Brochures,...)

<https://www.siemens.com/ic10>

Industry Mall (Online ordering system)

<https://mall.industry.siemens.com/mall/en/en/Catalog/product?mlfb=3SE2283-6GA53>

Cax online generator

<http://support.automation.siemens.com/WW/CAXorder/default.aspx?lang=en&mlfb=3SE2283-6GA53>

Service&Support (Manuals, Certificates, Characteristics, FAQs,...)

<https://support.industry.siemens.com/cs/ww/en/ps/3SE2283-6GA53>

Image database (product images, 2D dimension drawings, 3D models, device circuit diagrams, EPLAN macros, ...)

http://www.automation.siemens.com/bilddb/cax_de.aspx?mlfb=3SE2283-6GA53&lang=en

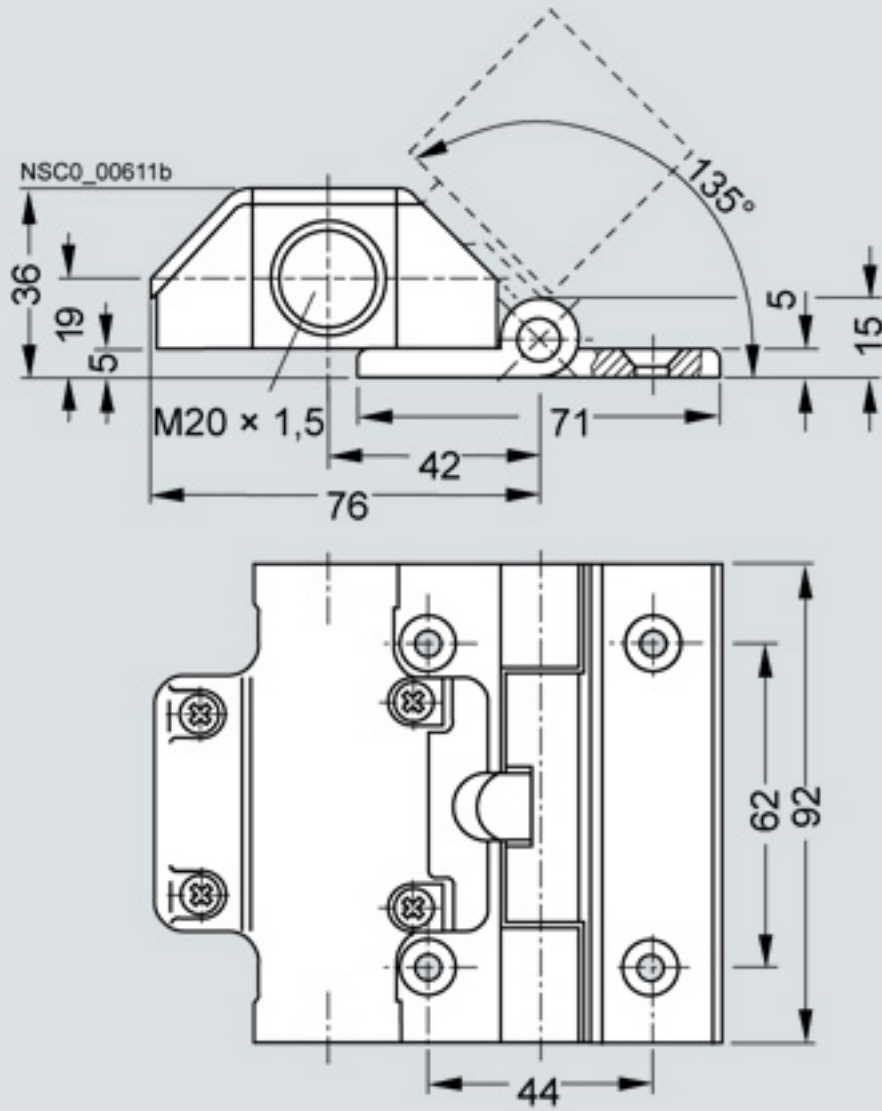

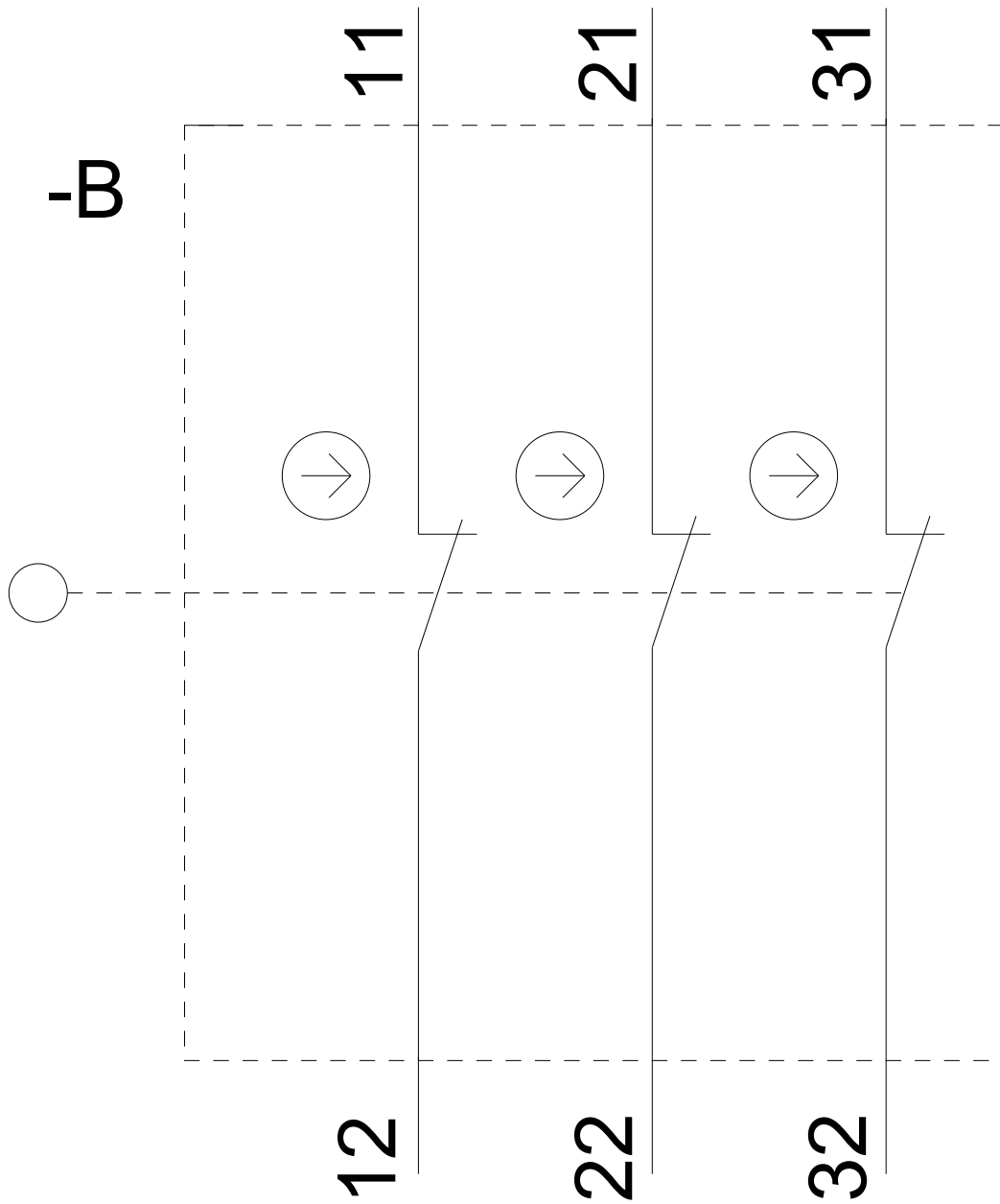

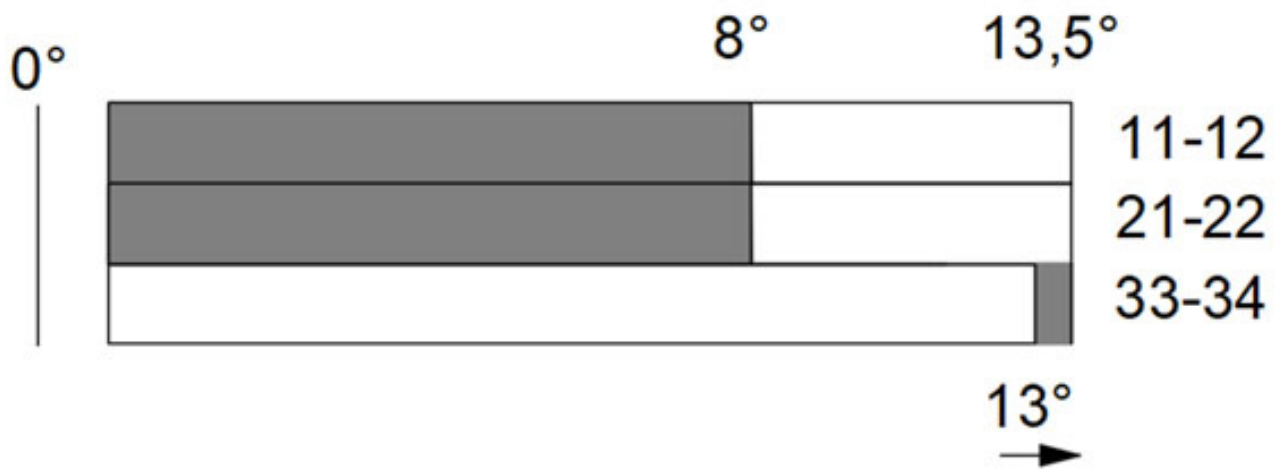

last modified:

08/05/2020