

Terminal block type E according to UL 508 for circuit breaker Size S00/S0











General technical data		
Product brand name		SIRIUS
Product designation		Terminal block
Design of the product		Type E
Size of the circuit-breaker		S00, S0
Protection class IP on the front		IP20
Insulation voltage with degree of pollution 3 at AC rated value	V	690
Ambient temperature		
• during storage	°C	-50 ... +80
• during operation	°C	-20 ... +60
Ampacity maximum	A	40
Installation/ mounting/ dimensions		
Width	mm	44.8
Height	mm	38.9
Depth	mm	73.6
Suitability for use enables assembly of self-protected combination motor controllers (type E) acc. to UL 508		a construction with 3RV1915 bus bars is not possible
Note		



Connections/ Terminals

Type of electrical connection for main current circuit		screw-type terminals
Type of connectable conductor cross-sections		
<ul style="list-style-type: none"> • for main contacts <ul style="list-style-type: none"> — solid — stranded — finely stranded <ul style="list-style-type: none"> — with core end processing • at AWG conductors for main contacts 		2x (1 ... 10 mm ²) 2x (2.5 ... 16 mm ²), 1x (1.5 ... 25) 1x (1 ... 16 mm ²), 2x (1 ... 10 mm ²) 1x (14 ... 3), 1x (16 ... 3), (14 ... 6), (16 ... 3)

Certificates/ approvals

Certificate of suitability	CE / UL / CSA / CCC		
General Product Approval	Declaration of Conformity	Test Certificates	
 CSA	 UL	 EAC	 EG-Konf.
		Miscellaneous	Special Test Certificate

Test Certificates	Shipping Approval				
Type Test Certificates/Test Report	 ABS	 BUREAU VERITAS	 Lloyd's Register LRS	 PRS	 RINA

Shipping Approval	other	Railway
 RMRS	Confirmation	Vibration and Shock
	 VDE	

Further information

Information- and Downloadcenter (Catalogs, Brochures,...)

<https://www.siemens.com/ic10>

Industry Mall (Online ordering system)

<https://mall.industry.siemens.com/mall/en/en/Catalog/product?mlfb=3RV2928-1H>

Cax online generator

<http://support.automation.siemens.com/WW/CAXorder/default.aspx?lang=en&mlfb=3RV2928-1H>

Service&Support (Manuals, Certificates, Characteristics, FAQs,...)

<https://support.industry.siemens.com/cs/ww/en/ps/3RV2928-1H>

Image database (product images, 2D dimension drawings, 3D models, device circuit diagrams, EPLAN macros, ...)

http://www.automation.siemens.com/bilddb/cax_de.aspx?mlfb=3RV2928-1H&lang=en

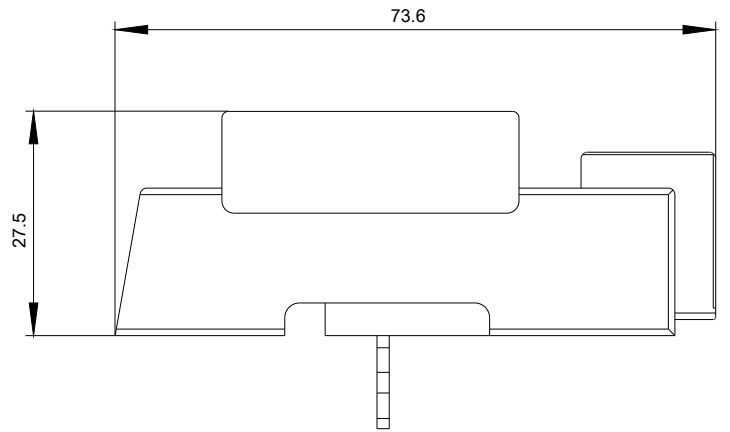
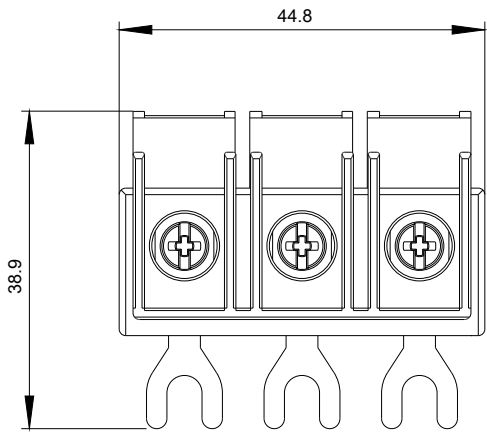

last modified:

03/05/2020