

Contactor, AC-1, 275 A/690 V/40 °C, S6, 3-pole, 220-240 V AC/DC, with varistor, 2 NO+2 NC, Connection rail/ screw terminal



product brand name	SIRIUS
Product designation	Contactor
Product type designation	3RT14
<b>General technical data</b>	
Size of contactor	S6
Product extension	
<ul style="list-style-type: none"> <li>function module for communication</li> </ul>	No
<ul style="list-style-type: none"> <li>Auxiliary switch</li> </ul>	Yes
<ul style="list-style-type: none"> <li>Insulation voltage of main circuit with degree of pollution 3 rated value</li> </ul>	1 000 V
<ul style="list-style-type: none"> <li>Insulation voltage of auxiliary circuit with degree of pollution 3 rated value</li> </ul>	690 V
Surge voltage resistance	
<ul style="list-style-type: none"> <li>of main circuit rated value</li> </ul>	8 kV
<ul style="list-style-type: none"> <li>of auxiliary circuit rated value</li> </ul>	6 kV
<ul style="list-style-type: none"> <li>protection class IP on the front</li> </ul>	IP00; IP20 on the front with cover / box terminal
<ul style="list-style-type: none"> <li>Protection class IP of the terminal</li> </ul>	IP00
Shock resistance at rectangular impulse	
<ul style="list-style-type: none"> <li>at AC</li> </ul>	8,5g / 5 ms, 4,2g / 10 ms

<ul style="list-style-type: none"> <li>• at DC</li> </ul>	8,5g / 5 ms, 4,2g / 10 ms
<b>Shock resistance with sine pulse</b>	
<ul style="list-style-type: none"> <li>• at AC</li> </ul>	13,4g / 5 ms, 6,5g / 10 ms
<ul style="list-style-type: none"> <li>• at DC</li> </ul>	13,4g / 5 ms, 6,5g / 10 ms
<b>Mechanical service life (switching cycles)</b>	
<ul style="list-style-type: none"> <li>• of contactor typical</li> </ul>	10 000 000
<ul style="list-style-type: none"> <li>• of the contactor with added electronics-compatible auxiliary switch block typical</li> </ul>	5 000 000
<ul style="list-style-type: none"> <li>• of the contactor with added auxiliary switch block typical</li> </ul>	10 000 000
<b>Reference code acc. to DIN EN 81346-2</b>	Q

#### Ambient conditions

<b>Installation altitude at height above sea level</b>	
<ul style="list-style-type: none"> <li>• maximum</li> </ul>	2 000 m
<b>Ambient temperature</b>	
<ul style="list-style-type: none"> <li>• during operation</li> </ul>	-25 ... +60 °C
<ul style="list-style-type: none"> <li>• during storage</li> </ul>	-55 ... +80 °C
Relative humidity during operation	95 %

#### Main circuit

<b>Number of poles for main current circuit</b>	3
<b>Number of NO contacts for main contacts</b>	3
<b>Type of voltage for main current circuit</b>	AC
<b>Operating voltage</b>	
<ul style="list-style-type: none"> <li>• at AC <ul style="list-style-type: none"> <li>— at 50 Hz rated value</li> <li>— at 60 Hz rated value</li> </ul> </li> </ul>	240 V 240 V
<b>Operating current</b>	
<ul style="list-style-type: none"> <li>• at AC-1 <ul style="list-style-type: none"> <li>— up to 690 V at ambient temperature 40 °C rated value</li> <li>— up to 690 V at ambient temperature 55 °C rated value</li> <li>— up to 690 V at ambient temperature 60 °C rated value</li> </ul> </li> <li>• at AC-3 at 400 V rated value</li> </ul>	275 A 250 A 250 A 97 A
<b>Minimum cross-section in main circuit</b>	
<ul style="list-style-type: none"> <li>• at maximum AC-1 rated value</li> </ul>	140 mm <sup>2</sup>
<b>No-load switching frequency</b>	
<ul style="list-style-type: none"> <li>• at AC</li> <li>• at DC</li> </ul>	2 000 1/h 2 000 1/h
<b>Operating frequency</b>	
<ul style="list-style-type: none"> <li>• at AC-1 maximum</li> </ul>	600 1/h

Control circuit/ Control	
<b>type of voltage</b>	AC/DC
<b>Type of voltage of the control supply voltage</b>	AC/DC
<b>Control supply voltage at AC</b>	
• at 50 Hz rated value	220 ... 240 V
• at 60 Hz rated value	220 ... 240 V
<b>Control supply voltage at DC</b>	
• rated value	220 ... 240 V
<b>Operating range factor control supply voltage rated value of magnet coil at DC</b>	
• initial value	0.8
• Full-scale value	1.1
<b>Operating range factor control supply voltage rated value of magnet coil at AC</b>	
• at 50 Hz	0.8 ... 1.1
• at 60 Hz	0.8 ... 1.1
<b>Design of the surge suppressor</b>	with varistor
<b>Apparent pick-up power of magnet coil at AC</b>	
• at 50 Hz	300 V·A
<b>Inductive power factor with closing power of the coil</b>	
• at 50 Hz	0.9
<b>Apparent holding power of magnet coil at AC</b>	
• at 50 Hz	5.8 V·A
<b>Inductive power factor with the holding power of the coil</b>	
• at 50 Hz	0.8
<b>Closing power of magnet coil at DC</b>	360 W
<b>Holding power of magnet coil at DC</b>	5.2 W
<b>Closing delay</b>	
• at AC	20 ... 95 ms
• at DC	20 ... 95 ms
<b>Opening delay</b>	
• at AC	40 ... 60 ms
• at DC	40 ... 60 ms
<b>Arcing time</b>	10 ... 15 ms
<b>Control version of the switch operating mechanism</b>	Standard A1 - A2
Auxiliary circuit	
<b>Number of NC contacts for auxiliary contacts</b>	2
• attachable	4
• instantaneous contact	2
<b>Number of NO contacts for auxiliary contacts</b>	2
• attachable	4

• instantaneous contact	2
Operating current at AC-12 maximum	10 A
<b>Operating current at AC-15</b>	
• at 230 V rated value	6 A
• at 400 V rated value	3 A
• at 500 V rated value	2 A
• at 690 V rated value	1 A
<b>Operating current at DC-13</b>	
• at 24 V rated value	10 A
• at 48 V rated value	2 A
• at 60 V rated value	2 A
• at 110 V rated value	1 A
• at 125 V rated value	0.9 A
• at 220 V rated value	0.3 A
• at 600 V rated value	0.1 A
<b>Design of the miniature circuit breaker</b>	
• for short-circuit protection of the auxiliary switch required	gG: 10 A (230 V, 400 A)
<b>contact reliability of auxiliary contacts</b>	1 faulty switching per 100 million (17 V, 1 mA)

### Short-circuit protection

<b>Product function Short circuit protection</b>	No
<b>Design of the fuse link</b>	
• for short-circuit protection of the main circuit	
— with type of coordination 1 required	gG: 355 A (690 V, 100 kA)
— with type of assignment 2 required	gR: 350 A (690 V, 100 kA)
• for short-circuit protection of the auxiliary switch required	gG: 10 A (500 V, 1 kA)

### Installation/ mounting/ dimensions

• <b>mounting position</b>	with vertical mounting surface +/-90° rotatable, with vertical mounting surface +/- 22.5° tiltable to the front and back
<b>Mounting type</b>	screw fixing
• Side-by-side mounting	Yes
<b>Height</b>	172 mm
<b>Width</b>	120 mm
<b>Depth</b>	170 mm
<b>Required spacing</b>	
• with side-by-side mounting	
— forwards	20 mm
— upwards	10 mm
— downwards	10 mm
— at the side	0 mm
• for grounded parts	

— forwards	20 mm
— upwards	10 mm
— at the side	10 mm
— downwards	10 mm
• for live parts	
— forwards	20 mm
— upwards	10 mm
— downwards	10 mm
— at the side	10 mm

### Connections/ Terminals



<b>Width of connection bar</b>	17 mm
<b>Thickness of connection bar</b>	3 mm
<b>Diameter of holes</b>	9 mm
<b>Number of holes</b>	1
<ul style="list-style-type: none"> <li>• Type of electrical connection for main current circuit</li> <li>• Type of electrical connection for auxiliary and control current circuit</li> <li>• Type of electrical connection at contactor for auxiliary contacts</li> <li>• Type of electrical connection of magnet coil</li> </ul>	<p>Connection bar</p> <p>screw-type terminals</p> <p>Screw-type terminals</p> <p>Screw-type terminals</p>
<b>Type of connectable conductor cross-sections</b>	
<ul style="list-style-type: none"> <li>• at AWG conductors for main contacts</li> </ul>	4 ... 250 kcmil
<b>Connectable conductor cross-section for main contacts</b>	
<ul style="list-style-type: none"> <li>• single or multi-stranded</li> <li>• stranded</li> </ul>	<p>25 ... 120 mm<sup>2</sup></p> <p>25 ... 120 mm<sup>2</sup></p>
<b>Connectable conductor cross-section for auxiliary contacts</b>	
<ul style="list-style-type: none"> <li>• single or multi-stranded</li> <li>• finely stranded with core end processing</li> </ul>	<p>0.5 ... 4 mm<sup>2</sup></p> <p>0.5 ... 2.5 mm<sup>2</sup></p>
<b>Type of connectable conductor cross-sections</b>	
<ul style="list-style-type: none"> <li>• for auxiliary contacts <ul style="list-style-type: none"> <li>— solid</li> <li>— single or multi-stranded</li> <li>— finely stranded with core end processing</li> </ul> </li> <li>• at AWG conductors for auxiliary contacts</li> </ul>	<p>2x (0.5 ... 1.5 mm<sup>2</sup>), 2x (0.75 ... 2.5 mm<sup>2</sup>), max. 2x (0.75 ... 4 mm<sup>2</sup>)</p> <p>2x (0,5 ... 1,5 mm<sup>2</sup>), 2x (0,75 ... 2,5 mm<sup>2</sup>), max. 2x (0,75 ... 4 mm<sup>2</sup>)</p> <p>2x (0.5 ... 1.5 mm<sup>2</sup>), 2x (0.75 ... 2.5 mm<sup>2</sup>)</p> <p>2x (20 ... 16), 2x (18 ... 14), 1x 12</p>

### Safety related data

<b>Product function</b>	
<ul style="list-style-type: none"> <li>• Mirror contact acc. to IEC 60947-4-1</li> <li>• positively driven operation acc. to IEC 60947-5-1</li> </ul>	<p>Yes</p> <p>No</p>

## Certificates/ approvals

General Product Approval				EMC	Functional Safety/Safety of Machinery
 CCC	 CSA	 UL		 RCM	<a href="#">Type Examination Certificate</a>

Declaration of Conformity	Test Certificates		Marine / Shipping		
 EG-Konf.	<a href="#">Miscellaneous</a>	<a href="#">Special Test Certificate</a>	<a href="#">Type Test Certificates/Test Report</a>	 ABS	 RMRS

Marine / Shipping	other	Railway	
 DNV-GL DNVGL.COM/AF	<a href="#">Confirmation</a>	<a href="#">Miscellaneous</a>	<a href="#">Special Test Certificate</a>

## Further information

## Information- and Downloadcenter (Catalogs, Brochures,...)

<https://www.siemens.com/ic10>

## Industry Mall (Online ordering system)

<https://mall.industry.siemens.com/mall/en/en/Catalog/product?mlfb=3RT1456-6AP36>

## Cax online generator

<http://support.automation.siemens.com/WW/CAXorder/default.aspx?lang=en&mlfb=3RT1456-6AP36>

## Service&amp;Support (Manuals, Certificates, Characteristics, FAQs,...)

<https://support.industry.siemens.com/cs/ww/en/ps/3RT1456-6AP36>

## Image database (product images, 2D dimension drawings, 3D models, device circuit diagrams, EPLAN macros, ...)

[http://www.automation.siemens.com/bilddb/cax\\_de.aspx?mlfb=3RT1456-6AP36&lang=en](http://www.automation.siemens.com/bilddb/cax_de.aspx?mlfb=3RT1456-6AP36&lang=en)

Characteristic: Tripping characteristics, I<sub>t</sub>, Let-through current

<https://support.industry.siemens.com/cs/ww/en/ps/3RT1456-6AP36/char>

## Further characteristics (e.g. electrical endurance, switching frequency)

<http://www.automation.siemens.com/bilddb/index.aspx?view=Search&mlfb=3RT1456-6AP36&objecttype=14&gridview=view1>

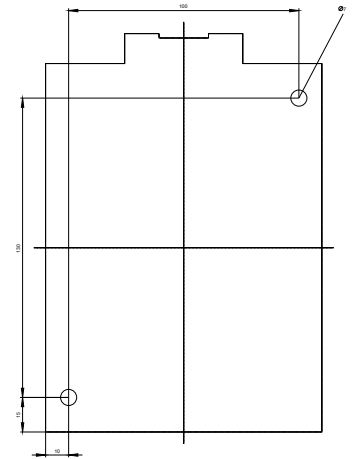
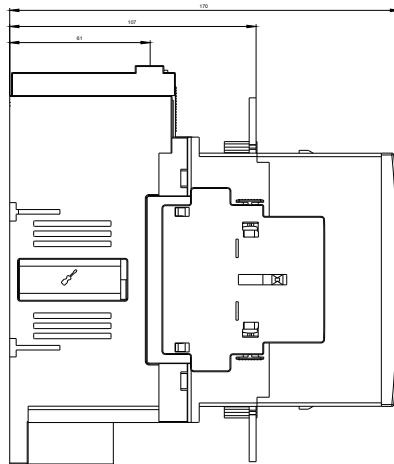
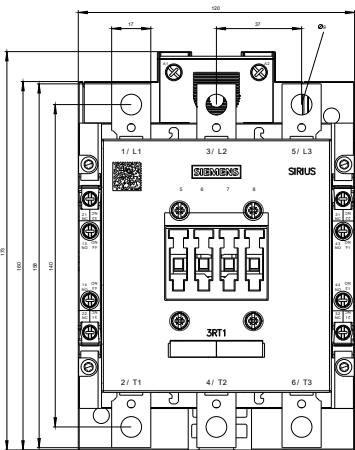

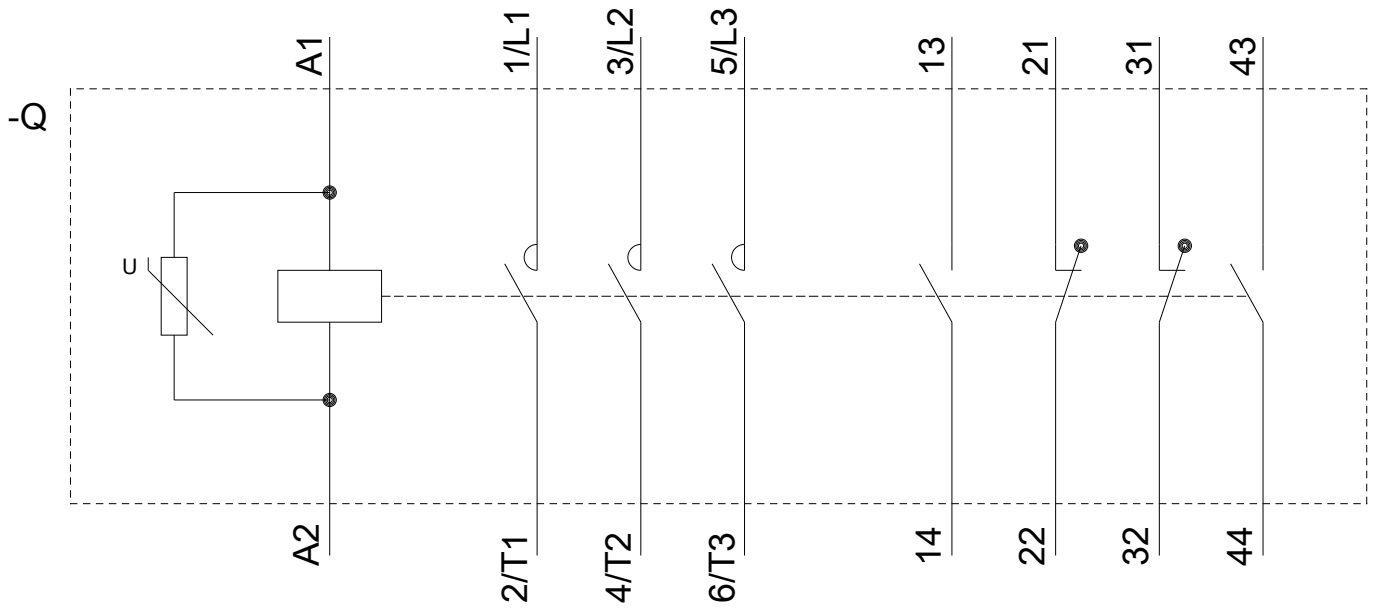

last modified:

08/13/2020