





Schutzkragen für NOT-HALT-Pilzdrucktaster, ohne oder mit RONIS-Schloss, 22 mm-Design, gelb, Kunststoff



Produkt-Markename	SIRIUS ACT
Produkt-Bezeichnung	Schutzkragen
Ausführung des Produkts	für NOT-HALT-Pilzdrucktaster ohne Schloss oder mit RONIS-Schloss
Produkttyp-Bezeichnung	3SU1
Allgemeine technische Daten	
Schutzart IP	IP66, IP67, IP69(IP69K)
Schutzart NEMA	1, 2, 3, 3R, 4, 4X, 12
Einbau/ Befestigung/ Abmessungen	
Höhe	58,9 mm
Breite	74,8 mm
Tiefe	47,5 mm
Zubehör	
Material des Zubehörs	Kunststoff
Farbe des Zubehörs	gelb
Approbationen/ Zertifikate	

allgemeine Produktzulassung			Konformitätserklärung	Prüfbescheinigungen
 CSA	 UL		 EG-Konf.	Sonstige Typprüfbescheinigung/Werkzeugnis

Marine / Schiffbau					Sonstige
 ABS	 LRS	 PRS	 RINA	 RMRS	Bestätigungen

Weitere Informationen

Information- and Downloadcenter (Kataloge, Broschüren,...)

<https://www.siemens.de/ic10>

Industry Mall (Online-Bestellsystem)

<https://mall.industry.siemens.com/mall/de/de/Catalog/product?mlfb=3SU1900-0DY30-0AA0>

CAX-Online-Generator

<http://support.automation.siemens.com/WW/CAXorder/default.aspx?lang=de&mlfb=3SU1900-0DY30-0AA0>

Service&Support (Handbücher, Betriebsanleitungen, Zertifikate, Kennlinien, FAQs,...)

<https://support.industry.siemens.com/cs/ww/de/ps/3SU1900-0DY30-0AA0>

Bilddatenbank (Produktfotos, 2D-Maßzeichnungen, 3D-Modelle, Geräteschaltpläne, EPLAN Makros, ...)

http://www.automation.siemens.com/bilddb/cax_de.aspx?mlfb=3SU1900-0DY30-0AA0&lang=de

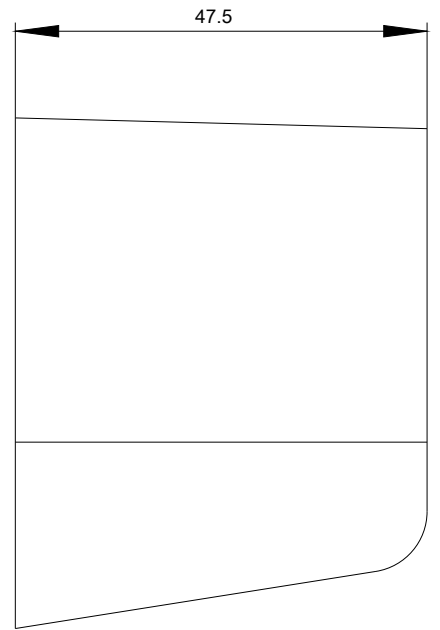
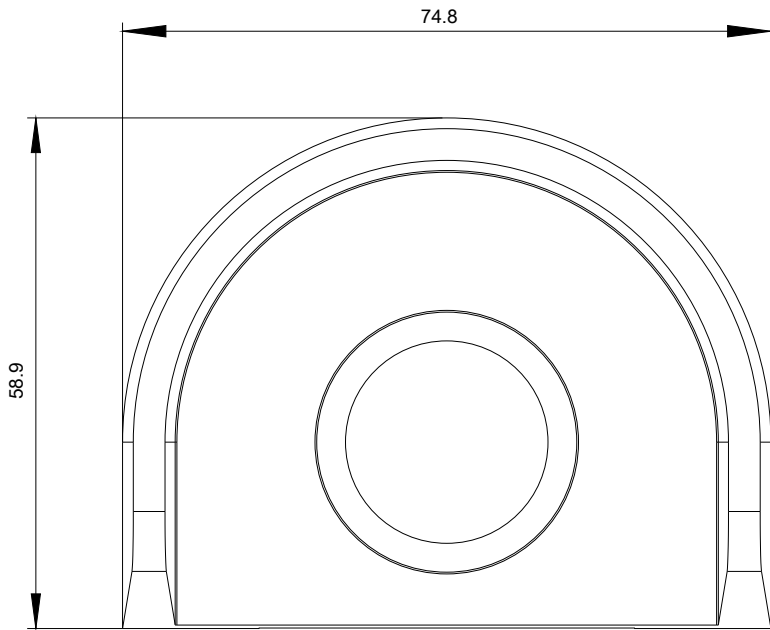

letzte Änderung:

09.07.2020