

Einlegeschild für Leuchtdrucktaster, rund, milchig mit schwarzer Schrift, mit Beschriftung: Zu



Produkt-Markename	SIRIUS ACT
Produkt-Bezeichnung	Einlegeschild
Produkttyp-Bezeichnung	3SU1





Allgemeine technische Daten





Schockfestigkeit <ul style="list-style-type: none">für Bahnanwendungen gemäß DIN EN 61373	Kategorie 1, Klasse B
Schwingfestigkeit <ul style="list-style-type: none">für Bahnanwendungen gemäß DIN EN 61373	Kategorie 1, Klasse B

Zubehör

Material des Zubehörs	Kunststoff
Befestigungsart des Schilds	einlegen
Kennzeichnung des Einlegeschilds	Zu
Form des Einlegeschilds	rund
Farbe des Einlegeschilds	milchig/schwarz (Schild/Schrift)

Approbationen/ Zertifikate

allgemeine Produktzulassung		Konformitätserklärung		Prüfbescheinigungen
 CSA	 UL		 EG-Konf.	Sonstige Typprüfbescheinigung/Werkszeugnis

Marine / Schiffbau					Sonstige
 ABS	 LRS	 PRS	 RINA	 RMRS	Bestätigungen

Weitere Informationen

Information- and Downloadcenter (Kataloge, Broschüren,...)

<https://www.siemens.de/ic10>

Industry Mall (Online-Bestellsystem)

<https://mall.industry.siemens.com/mall/de/de/Catalog/product?mlfb=3SU1900-0AB71-0AL0>

CAX-Online-Generator

<http://support.automation.siemens.com/WW/CAXorder/default.aspx?lang=de&mlfb=3SU1900-0AB71-0AL0>

Service&Support (Handbücher, Betriebsanleitungen, Zertifikate, Kennlinien, FAQs,...)

<https://support.industry.siemens.com/cs/ww/de/ps/3SU1900-0AB71-0AL0>

Bilddatenbank (Produktfotos, 2D-Maßzeichnungen, 3D-Modelle, Geräteschaltpläne, EPLAN Makros, ...)

http://www.automation.siemens.com/bilddb/cax_de.aspx?mlfb=3SU1900-0AB71-0AL0&lang=de

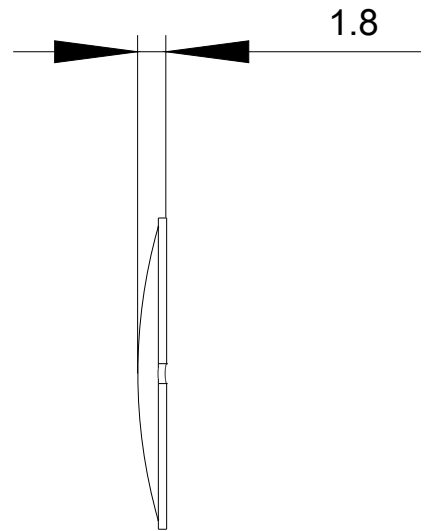
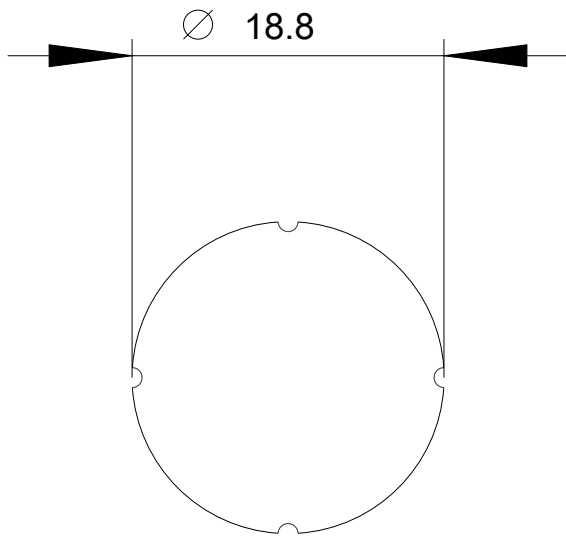

letzte Änderung:

20.07.2020