

NX-series EtherNet/IP™ Coupler Unit

NX-EIC

CSM_NX-EIC_DS_E_4_3

Connecting to open industrial network standard EtherNet/IP

- The EtherNet/IP Coupler Unit is the link between the EtherNet/IP multivendor network and the NX-series I/O Units and Safety Units. With wide variety of the I/O Units and Safety Units, the NX-series is the perfect match for the CJ-series and multivendor Controllers.



Features

- Up to 63 NX-IO Units can be connected to one EtherNet/IP Coupler Unit. Standard and high-performance units can be mixed.*
 - Each Coupler plus its I/O form just a single EtherCAT node on the network.
 - I/O control and safety control can be integrated by connecting Units for safety.
 - The IP address can be found on the label on the Unit, without using software.
 - Slave configuration by Sysmac Studio can be done centrally via the controller, or on-the-spot using the Coupler's built-in USB port.
- * Input per Coupler Unit: Maximum 504 bytes, Output per Coupler Unit: Maximum 504 bytes

System Configuration

System Configuration of Slave Terminals

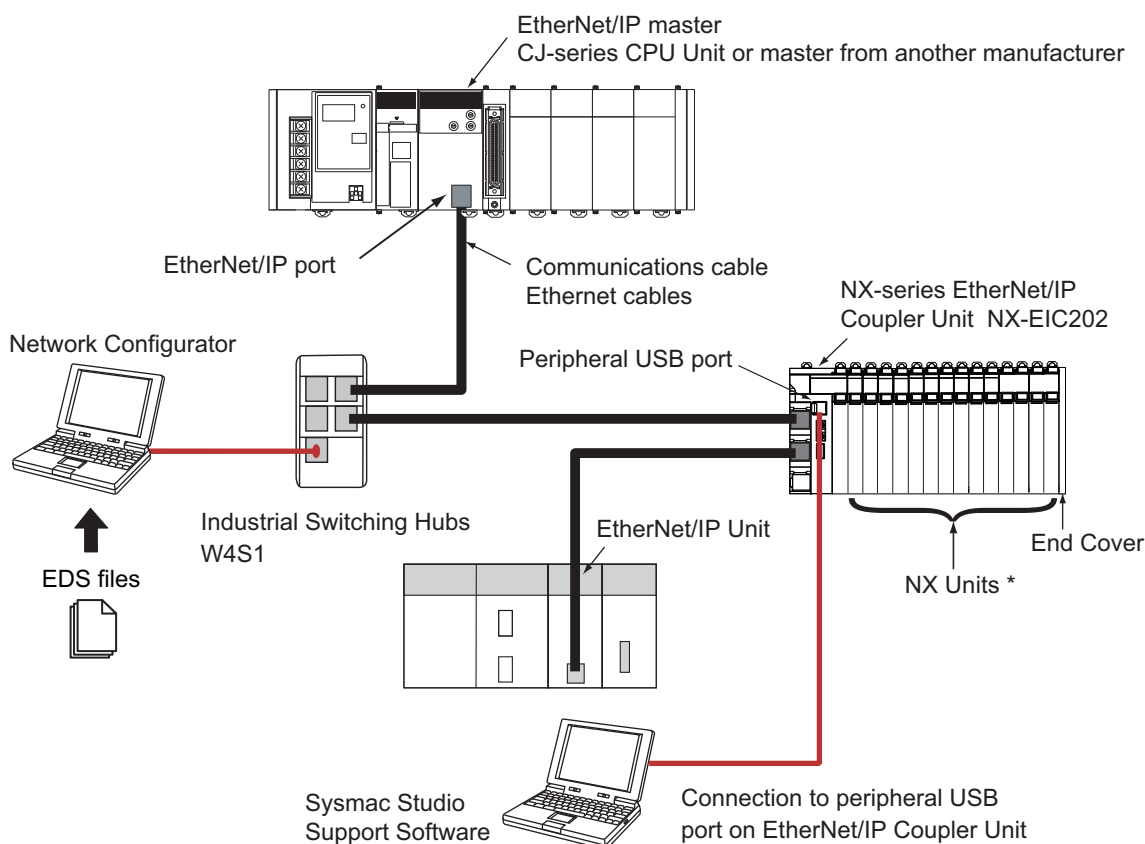

Note: Do not make a loop connection in the communications path between Ethernet switches.

* Refer to *Configuration Unit* on page 8 for the NX Units that can be connected to the NX-series EtherNet/IP Coupler Unit.

Sysmac is a trademark or registered trademark of OMRON Corporation in Japan and other countries for OMRON factory automation products. EtherCAT® is a registered trademark of Beckhoff Automation GmbH for their patented technology. EtherNet/IP™ is the trademarks of ODVA. Other company names and product names in this document are the trademarks or registered trademarks of their respective companies.

Ordering Information

Applicable standards

Refer to the OMRON website (www.ia.omron.com) or ask your OMRON representative for the most recent applicable standards for each model.

EtherNet/IP Coupler Unit

Product name	Current consumption	Maximum I/O power supply current	Model
	1.60 W or lower	10 A	NX-EIC202

Automation Software Sysmac Studio

Please purchase a DVD and required number of licenses the first time you purchase the Sysmac Studio. DVDs and licenses are available individually. Each model of licenses does not include any DVD.

Product name	Specifications	Number of licenses	Media	Model
Sysmac Studio NX-I/O Edition Ver.1.□□	Sysmac Studio NX-I/O Edition is a limited license that provides selected functions required for EtherNet/IP Coupler settings. Because this product is a license only, you need the Sysmac Studio Standard Edition DVD media to install it.	1 license	---	SYSMAC-NE001L
Sysmac Studio Standard Edition Ver.1.□□	The Sysmac Studio is the software that provides an integrated environment for setting, programming, debugging and maintenance of machine automation controllers including the NJ/NX-series CPU Units, NY-series Industrial PC, EtherCAT Slave, and the HMI.	--- (Media only)	Sysmac Studio (32-bit) DVD	SYSMAC-SE200D
	Sysmac Studio runs on the following OS. Windows 7 (32-bit/64-bit version)/ Windows 8 (32-bit/64-bit version)/ Windows 8.1 (32-bit/64-bit version)/ Windows 10 (32-bit/64-bit version) *1	--- (Media only)	Sysmac Studio (64-bit) DVD	SYSMAC-SE200D-64
	This software provides functions of the Vision Edition. Refer to your OMRON website for details such as supported models and functions.	1 license *2 *3 *4	---	SYSMAC-SE201L

*1. Model "SYSMAC-SE200D-64" runs on Windows 10 (64 bit).

*2. The Sysmac Studio Standard Edition with license(s) (SYSMAC-SE□□□L) provides functions of the NX-I/O Edition (SYSMAC-NE001L).

*3. With the Sysmac Studio Standard Edition with license(s) (SYSMAC-SE□□□L) version 1.10 or higher, you can use the setup functions for the EtherNet/IP Coupler.

*4. Multi licenses are available for the Sysmac Studio (3, 10, 30, or 50 licenses).

Connecting Cable

Peripheral (USB) Port





Use a commercially available USB-certified cable.

Specifications: USB 1.1 or 2.0 cable (A connector - B connector), 5.0 m max.

Recommended EtherNet/IP Communications Cables

For EtherNet/IP, required specification for the communications cables varies depending on the baud rate. For 100BASE-TX/10BASE-T, use a straight or cross STP (shielded twisted-pair) cable of category 5 or higher. For 1000BASE-T, use a straight or cross STP cable of category 5e or higher with double shielding (aluminum tape and braiding).

Cable with Connectors

Item	Appearance	Recommended manufacturer	Cable length (m)	Model
Cable with Connectors on Both Ends (RJ45/RJ45) Standard RJ45 plugs type *1 Wire Gauge and Number of Pairs: AWG26, 4-pair Cable Cable Sheath material: LSZH *2 Cable color: Yellow *3		OMRON	0.3	XS6W-6LSZH8SS30CM-Y
			0.5	XS6W-6LSZH8SS50CM-Y
			1	XS6W-6LSZH8SS100CM-Y
			2	XS6W-6LSZH8SS200CM-Y
			3	XS6W-6LSZH8SS300CM-Y
			5	XS6W-6LSZH8SS500CM-Y
Cable with Connectors on Both Ends (RJ45/RJ45) Rugged RJ45 plugs type *1 Wire Gauge and Number of Pairs: AWG22, 2-pair Cable Cable color: Light blue		OMRON	0.3	XS5W-T421-AMD-K
			0.5	XS5W-T421-BMD-K
			1	XS5W-T421-CMD-K
			2	XS5W-T421-DMD-K
			5	XS5W-T421-GMD-K
			10	XS5W-T421-JMD-K
Cable with Connectors on Both Ends (M12 Straight/M12 Straight) Shield Strengthening Connector cable *4 M12/Smartclick Connectors Wire Gauge and Number of Pairs: AWG22, 2-pair Cable Cable color: Black		OMRON	0.5	XS5W-T421-BM2-SS
			1	XS5W-T421-CM2-SS
			2	XS5W-T421-DM2-SS
			3	XS5W-T421-EM2-SS
			5	XS5W-T421-GM2-SS
			10	XS5W-T421-JM2-SS
Cable with Connectors on Both Ends (M12 Straight/RJ45) Shield Strengthening Connector cable *4 M12/Smartclick Connectors Rugged RJ45 plugs type Wire Gauge and Number of Pairs: AWG22, 2-pair Cable Cable color: Black		OMRON	0.5	XS5W-T421-BMC-SS
			1	XS5W-T421-CMC-SS
			2	XS5W-T421-DMC-SS
			3	XS5W-T421-EMC-SS
			5	XS5W-T421-GMC-SS
			10	XS5W-T421-JMC-SS

*1. Standard type cables length 0.2, 0.3, 0.5, 1, 1.5, 2, 3, 5, 7.5, 10, 15 and 20 m are available. Rugged type cables length 0.3, 0.5, 1, 2, 3, 5, 10 and 15 m are available. For details, refer to Cat.No.G019.

*2. The lineup features Low Smoke Zero Halogen cables for in-cabinet use and PUR cables for out-of-cabinet use. Although the LSZH cable is single shielded, its communications and noise characteristics meet the standards.

*3. Cables colors are available in blue, yellow, or Green.

*4. For details, contact your OMRON representative.

Cables / Connectors

Item		Recommended manufacturer	Model
Products for EtherNet/IP (100BASE-TX)	Wire Gauge and Number of Pairs: AWG24, 4-pair Cable	Cables	Hitachi Cable, Ltd. NETSTAR-C5E SAB 0.5 × 4P CP *1
			Kuramo Electric Co. KETH-SB *1
			SWCC Showa Cable Systems Co. FAE-5004 *1
	RJ45 Connectors	Panduit Corporation MPS588-C *1	
Products for EtherNet/IP (100BASE-TX)	Wire Gauge and Number of Pairs: AWG22, 2-pair Cable	Cables	Kuramo Electric Co. KETH-PSB-OMR *2
			JMACS Japan Co., Ltd. PNET/B *2
		RJ45 Assembly Connector 	OMRON XS6G-T421-1 *2

*1. We recommend you to use above cable for EtherNet/IP and RJ45 Connector together.
 *2. We recommend you to use above cable for EtherNet/IP and RJ45 Assembly Connector together.

Optional Products

Product name	Specification	Model
Unit/Terminal Block Coding Pins	Pins for 10 Units (30 terminal block pins and 30 Unit pins)	NX-AUX02

Product name	Specification				Model
	No. of terminals	Terminal number indications	Ground terminal mark	Terminal current capacity	
Terminal Block	8	A/B	Provided	10 A	NX-TBC082

Accessories

End Cover (NX-END01)

One End Cover is provided together with the EtherNet/IP Coupler Unit.

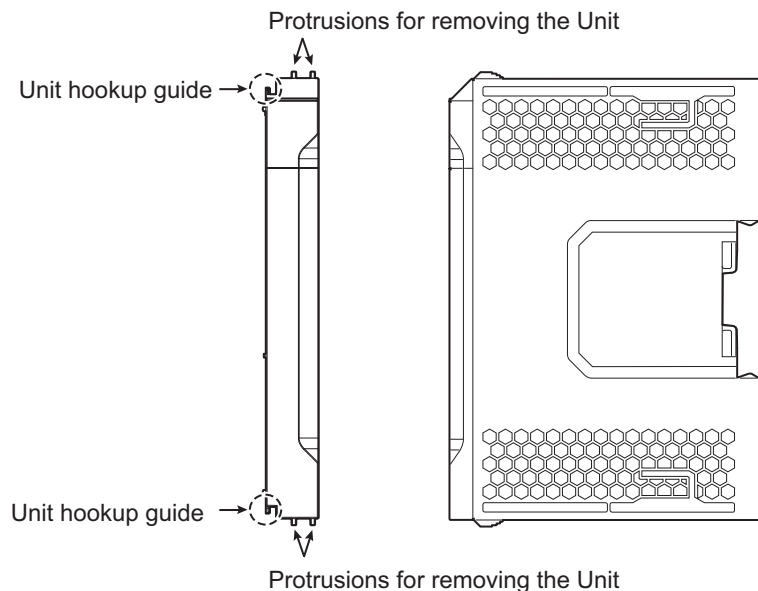

General Specification

Item	Specification	
Enclosure	Mounted in a panel	
Grounding method	Ground to 100 Ω or less	
Operating environment	Ambient operating temperature	0 to 55°C
	Ambient operating humidity	10% to 95% (with no condensation or icing)
	Atmosphere	Must be free from corrosive gases.
	Ambient storage temperature	-25 to 70°C (with no condensation or icing)
	Altitude	2,000 m max.
	Pollution degree	Pollution degree 2 or less: Meets IEC 61010-2-201.
	Noise immunity	Conforms to IEC 61000-4-4. 2 kV (power supply line)
	Overvoltage category	Category II: Meets IEC 61010-2-201.
	EMC immunity level	Zone B
Vibration resistance	Conforms to IEC 60068-2-6. 5 to 8.4 Hz with 3.5-mm amplitude, 8.4 to 150 Hz, acceleration of 9.8 m/s ² , 100 min each in X, Y, and Z directions (10 sweeps of 10 min each = 100 min total) *1	
Shock resistance	Conforms to IEC 60068-2-27. 147 m/s ² , 3 times each in X, Y, and Z directions *1	
Applicable standards *2	cULus: Listed UL508, ANSI/ISA 12.12.01 EU: EN 61131-2, C-Tick or RCM, KC: KC Registration	

*1. Refer to the *NX-series Digital I/O Units User's Manual* (Cat. No. W521) for the vibration and shock resistance specifications of the Relay Output Unit.

*2. Refer to the OMRON website (<http://www.ia.omron.com/>) or consult your OMRON representative for the most recent applicable standards for each model.

EtherNet/IP Coupler Unit Specifications

Item	Specification	
Model	NX-EIC202	
Number of connectable NX Units	63 Units max.*1	
Communications protocols	EtherNet/IP	
	UDP/IP and TCP/IP (Message Services)	Number of buffers (sockets): <ul style="list-style-type: none"> • 8 message buffers for server • No message buffers for client • Shared buffers for UDP/IP messages and TCP/IP messages Maximum message size: <ul style="list-style-type: none"> • Request: 492 bytes • Response: 496 bytes Maximum NX output data size: <ul style="list-style-type: none"> • 490 bytes Maximum NX input data size: <ul style="list-style-type: none"> • 496 bytes
Modulation	Baseband	
Link speed	100 Mbps	
Physical layer	100BASE-TX (IEEE 802.3)	
Number of connections	8	
Received Packet Interval (RPI, refresh cycle)	4 to 1,000 ms	
Allowed communications bandwidth addressing to the local node	1,000 pps	
Topology	Line, Tree, Star	
Ethernet Switch	Layer 2 Ethernet switch	
Transmission media	Category 5 or higher twisted-pair cable (Recommended cable: double-shielded cable with aluminum tape and braiding)	
Transmission distance	Distance between nodes: 100 m or less	
NX bus I/O data size	Input: 512 bytes max. (including input data, status, and unused areas) Output: 512 bytes max. (including output data and unused areas)	
EtherNet/IP I/O connection size	Input: 504 bytes max. (including input data, status, and unused areas) Output: 504 bytes max. (including output data and unused areas)	
Refreshing methods	Free-Run refreshing	
Unit power supply *2	Power supply voltage	24 VDC (20.4 to 28.8 VDC)
	NX Unit power supply capacity	10 W max. (Refer to <i>Installation orientation and restrictions</i> for details.)
	NX Unit power supply efficiency	70%
	Isolation method	No isolation between NX Unit power supply and Unit power supply terminals
	Current capacity of power supply terminals	4 A max.
I/O power supply *2	Power supply voltage	5 to 24 VDC (4.5 to 28.8 VDC) *3
	Maximum I/O power supply current	10 A (Refer to <i>Installation orientation and restrictions</i> for details.)
	Current capacity of power supply terminals	10 A max.
NX Unit power consumption	1.60 W max.	
Current consumption from I/O power supply	10 mA max. (for 24 VDC)	

*1. Refer to the *NX-series Safety Control Unit User's Manual* (Cat. No. Z930) for the number of Safety Control Units that can be connected.

*2. Refer to the *NX-series EtherNet/IP™ Coupler Unit User's Manual* (Cat. No. W536) for procedures for designing the Unit power supply system and I/O power supply system.

*3. Use a voltage that is appropriate for the I/O circuits of the NX Units and the connected external devices.

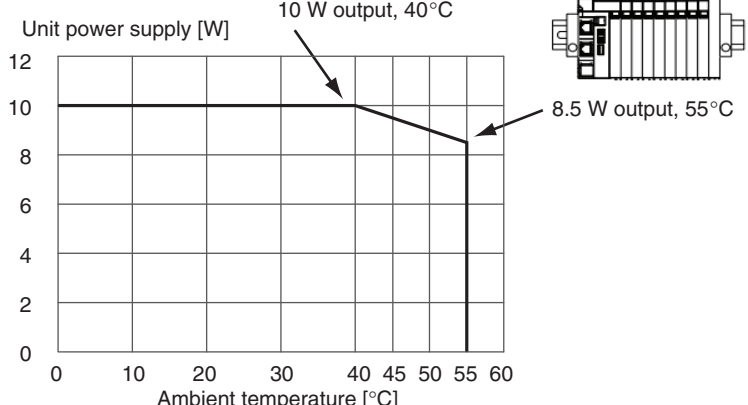
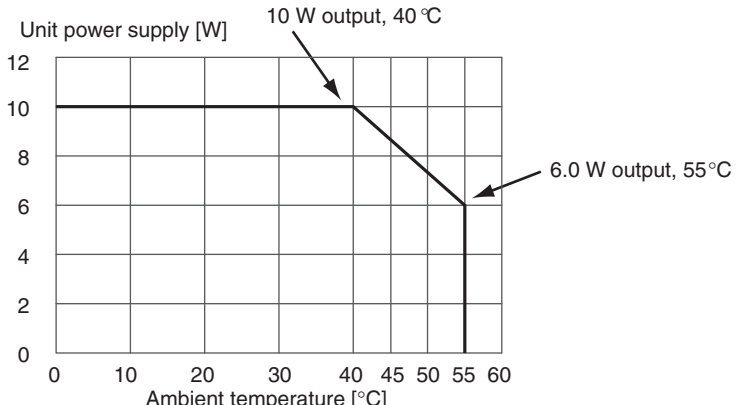
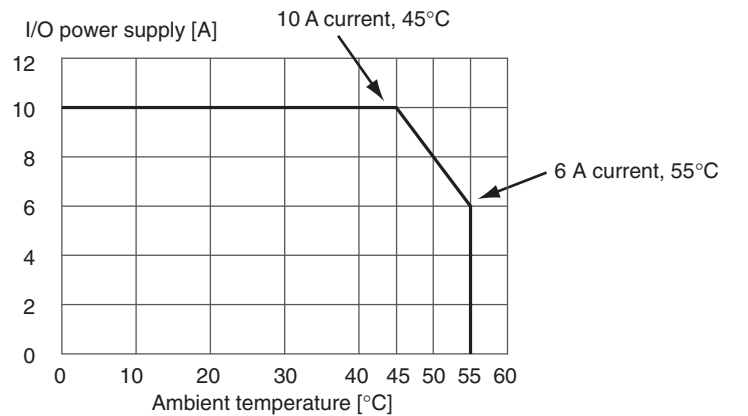
Item	Specification
Dielectric strength	510 VAC for 1 min, leakage current: 5 mA max. (between isolated circuits)
Insulation resistance	100 VDC, 20 MΩ min. (between isolated circuits)
External connection terminals	Communications Connector For EtherNet/IP communications. • RJ45 × 2 (shielded)
	Screwless Clamping Terminal Block For Unit power supply, I/O power supply, and grounding. Removable.
	Peripheral USB Port For Sysmac Studio connection. • Physical layer: USB 2.0-compliant, B-type connector • Transmission distance: 5 m max.
Dimensions	46 × 100 × 71 mm (W×H×D)
Weight	150 g max.
Installation orientation and restrictions	Installation orientation: 6 possible orientations Restrictions: • Used in the upright installation orientation.
	 <p>Unit power supply [W]</p> <p>Ambient temperature [°C]</p> <p>10 W output, 40°C</p> <p>8.5 W output, 55°C</p>
	<p>• Used in any other orientation than the upright installation orientation.</p>  <p>Unit power supply [W]</p> <p>Ambient temperature [°C]</p> <p>10 W output, 40°C</p> <p>6.0 W output, 55°C</p>
	 <p>I/O power supply [A]</p> <p>Ambient temperature [°C]</p> <p>10 A current, 45°C</p> <p>6 A current, 55°C</p>

Item	Specification
<p>Circuit layout</p>	
<p>Terminal arrangement</p>	
<p>Accessory</p>	<p>End Cover (NX-END01): 1</p>

Configuration Unit

Refer to the user's manuals for information on the NX Units that can be connected to the NX-series EtherNet/IP Coupler Unit.

EtherNet/IP Coupler Unit

Unit	Model
EtherNet/IP Coupler Unit	NX-EIC202

I/O Units

Unit	Model				
	2-point Units	4-point Units	8-point Units	16-point Units	32-point Units
Digital Input Unit	–	NX-ID3317 NX-ID3343 NX-ID3417 NX-ID3443 NX-IA3117	NX-ID4342 NX-ID4442	NX-ID5142-1 NX-ID5142-5 NX-ID5342 NX-ID5442	NX-ID6142-5 NX-ID6142-6
Digital Output Unit	NX-OC2633 NX-OC2733	NX-OD3121 NX-OD3153 NX-OD3256 NX-OD3257 NX-OD3268	NX-OD4121 NX-OD4256 NX-OC4633	NX-OD5121 NX-OD5121-1 NX-OD5121-5 NX-OD5256 NX-OD5256-1 NX-OD5256-5	NX-OD6121-5 NX-OD6256-5
Digital Mixed I/O Unit	–	–	–	NX-MD6121-5 NX-MD6121-6 NX-MD6256-5	–
Analog Input Unit	NX-AD2603 NX-AD2604 NX-AD2608 NX-AD2203 NX-AD2204 NX-AD2208	NX-AD3603 NX-AD3604 NX-AD3608 NX-AD3203 NX-AD3204 NX-AD3208	NX-AD4603 NX-AD4604 NX-AD4608 NX-AD4203 NX-AD4204 NX-AD4208	–	–
Analog Output Unit	NX-DA2603 NX-DA2605 NX-DA2203 NX-DA2205	NX-DA3603 NX-DA3605 NX-DA3203 NX-DA3205	–	–	–
Temperature Input Unit	NX-TS2101 NX-TS2102 NX-TS2104 NX-TS2201 NX-TS2202 NX-TS2204	NX-TS3101 NX-TS3102 NX-TS3104 NX-TS3201 NX-TS3202 NX-TS3204	–	–	–
Heater Burnout Detection Unit	–	NX-HB3101 NX-HB3201	–	–	–

Temperature Control Units

Unit	Model	
	2CH	4CH
Temperature Control Unit	NX-TC2405, NX-TC2406, NX-TC2407, NX-TC2408	NX-TC3405, NX-TC3406, NX-TC3407, NX-TC3408

Load Cell Input Unit

Unit	Model
Load Cell Input Unit	NX-RS1201

Position Interface Units

Unit	Model	
	1CH	2CH
Incremental Encoder Input Unit	NX-EC0112, NX-EC0122, NX-EC0132, NX-EC0142	NX-EC0212, NX-EC0222
SSI Input Unit	NX-ECS112	NX-ECS212
Pulse Output Unit	NX-PG0112, NX-PG0122	–

Communications Interface Units

Unit	Model
Communications Interface Unit	NX-CIF101, NX-CIF105, NX-CIF210

System Units

Unit	Model
Additional NX Unit Power Supply Unit	NX-PD1000
Additional I/O Power Supply Unit	NX-PF0630, NX-PF0730
I/O Power Supply Connection Unit	NX-PC0010, NX-PC0020, NX-PC0030
Shield Connection Unit	NX-TBX01

IO-Link Master Unit

Unit	Model
IO-Link Master Unit	NX-ILM400

Safety Control Units

Unit	Model
Safety CPU Unit	NX-SL3300 *1
Safety Input Unit	NX-SIH400 *2, NX-SID800
Safety Output Unit	NX-SOH200, NX-SOD400

*1. Safety CPU Unit Ver.1.1 or higher.

*2. Safety Input Unit Ver.1.1 or higher.

Version Information

Depending on the type and model of the Unit, some Units do not have all of the versions given in the corresponding versions. If a Unit does not have the specified version, support is provided by the oldest available version after the specified version. Refer to the user's manuals for the specific Units for the relation between models and versions.

Connection to the NJ/NX-series CPU Unit or NY-series Industrial PC NX-series CPU Unit or NY-series Industrial PC

EtherNet/IP Coupler Unit		Corresponding unit version/version			
Model	Unit version	Unit version of CPU Unit or Industrial PC	Sysmac Studio version	Network Configurator for EtherNet/IP version	CX-ConfiguratorFDT version
NX-EIC202	Ver.1.2	Ver.1.14	Ver.1.19	Ver.3.21	Ver.2.4 *
	Ver.1.0	Not possible.	Not possible.	Not possible.	Not possible.

* The CX-ConfiguratorFDT with version 2.2 or later can be used if it is connected to the peripheral USB port on the EtherNet/IP Coupler Unit.

NJ-series CPU Unit

EtherNet/IP Coupler Unit		Corresponding unit version/version				
Model	Unit version	Unit version of CPU Unit	Unit version of CJ1W-EIP21	Sysmac Studio version	Network Configurator for EtherNet/IP version	CX-ConfiguratorFDT version
NX-EIC202	Ver.1.2	Ver.1.14	Ver.2.1	Ver.1.19	Ver.3.21	Ver.2.4 *
	Ver.1.0	Not possible.	Not possible.	Not possible.	Not possible.	Not possible.

* The CX-ConfiguratorFDT with version 2.2 or later can be used if it is connected to the peripheral USB port on the EtherNet/IP Coupler Unit.

Connection to CS/CJ/CP-series CPU Unit CS1G/CS1H/CJ1H/CJ1M * CPU Units

* Final order entry date for CJ1M: The end of March, 2021

EtherNet/IP Coupler Unit		Corresponding unit version/version				
Model	Unit version	Unit version of CPU Unit	Unit version of CS1W-EIP21/CJ1W-EIP21	Network Configurator for EtherNet/IP version	NX-IO Configurator version	CX-ConfiguratorFDT version
NX-EIC202	Ver.1.2	Ver.3.0	Ver.2.1	Ver.3.00	Ver.1.00	Ver.2.4 *1
	Ver.1.0				Ver.1.00 *2	Ver.2.2

*1. The CX-ConfiguratorFDT with version 2.2 or later can be used if it is connected to the peripheral USB port on the EtherNet/IP Coupler Unit.

*2. You can connect only to the peripheral USB port on the EtherNet/IP Coupler Unit. You cannot connect with any other path.

CJ2H-CPU6□/CJ2M-CPU1□/CP1H CPU Unit

EtherNet/IP Coupler Unit		Corresponding unit version/version				
Model	Unit version	Unit version of CPU Unit	Unit version of CJ1W-EIP21	Network Configurator for EtherNet/IP version	NX-IO Configurator version	CX-ConfiguratorFDT version
NX-EIC202	Ver.1.2	Ver.1.0	Ver.2.1	Ver.3.00	Ver.1.00	Ver.2.4 *1
	Ver.1.0				Ver.1.00 *2	Ver.2.2

*1. The CX-ConfiguratorFDT with version 2.2 or later can be used if it is connected to the peripheral USB port on the EtherNet/IP Coupler Unit.

*2. You can connect only to the peripheral USB port on the EtherNet/IP Coupler Unit. You cannot connect with any other path.

CJ2H-CPU6□-EIP CPU Unit

EtherNet/IP Coupler Unit		Corresponding unit version/version				
Model	Unit version	Unit version of CPU Unit	Unit version of CJ1W-EIP21	Network Configurator for EtherNet/IP version	NX-IO Configurator version	CX-ConfiguratorFDT version
NX-EIC202	Ver.1.2	Ver.1.5	Ver.2.1	Ver.3.00	Ver.1.00	Ver.2.4 *1
	Ver.1.0				Ver.1.00 *2	Ver.2.2

*1. The CX-ConfiguratorFDT with version 2.2 or later can be used if it is connected to the peripheral USB port on the EtherNet/IP Coupler Unit.

*2. You can connect only to the peripheral USB port on the EtherNet/IP Coupler Unit. You cannot connect with any other path.

CJ2M-CPU3□ CPU Unit

EtherNet/IP Coupler Unit		Corresponding unit version/version				
Model	Unit version	Unit version of CPU Unit	Unit version of CJ1W-EIP21	Network Configurator for EtherNet/IP version	NX-IO Configurator version	CX-ConfiguratorFDT version
NX-EIC202	Ver.1.2	Ver.1.0	Ver.2.1	Ver.3.21	Ver.1.00	Ver.2.4 *1
	Ver.1.0				Ver.1.00 *2	Ver.2.2

*1. The CX-ConfiguratorFDT with version 2.2 or later can be used if it is connected to the peripheral USB port on the EtherNet/IP Coupler Unit.

*2. You can connect only to the peripheral USB port on the EtherNet/IP Coupler Unit. You cannot connect with any other path.

Connection to the Sysmac Gateway

Sysmac Gateway

EtherNet/IP Coupler Unit		Corresponding unit version/version			
Model	Unit version	Sysmac Gateway version	Network Configurator for EtherNet/IP version	NX-IO Configurator version	CX-ConfiguratorFDT version
NX-EIC202	Ver.1.2	Ver.1.31	Ver.3.50	Ver.1.00	Ver.2.4 *1
	Ver.1.0			Ver.1.00 *2	Ver.2.2

*1. The CX-ConfiguratorFDT with version 2.2 or later can be used if it is connected to the peripheral USB port on the EtherNet/IP Coupler Unit.

*2. You can connect only to the peripheral USB port on the EtherNet/IP Coupler Unit. You cannot connect with any other path.

External Interface

EtherNet/IP Coupler Unit NX-EIC202

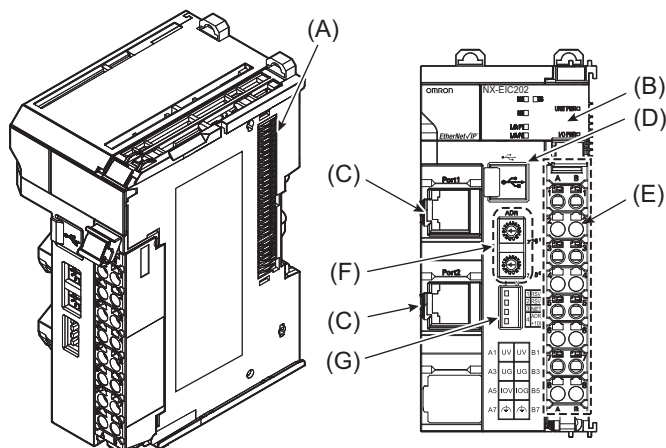

Letter	Name	Function
(A)	NX bus connector	This connector is used to connect the EtherNet/IP Coupler Unit to the NX Unit on the right of the Coupler Unit.
(B)	Indicators	The indicators show the current operating status of the Unit and the status of the power supply.
(C)	Communications connectors	These connectors are connected to the communications cables of the EtherNet/IP network.
(D)	Peripheral USB port	This port is used to connect to the Sysmac Studio.
(E)	Terminal block	The terminal block is used to connect to the power supply cables and ground wire.
(F)	Rotary switches	The rotary switches are used to set the last octet of the IP address of the EtherNet/IP Coupler Unit as an EtherNet/IP Slave. The address is set in hexadecimal.
(G)	DIP switch	The DIP switch is used to set the default node address of the EtherNet/IP Coupler Unit as an EtherNet/IP slave.

Terminal Block

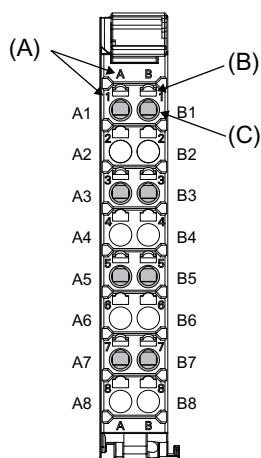

Eight-terminal Block

Symbol	Name	Function
(A)	Terminal number indications	The terminal numbers (A1 to A8 and B1 to B8) are displayed. The terminal number indicators are the same regardless of the number of terminals on the terminal block, as shown above.
(B)	Release holes	Insert a flat-blade screwdriver into these holes to connect and remove the wires.
(C)	Terminal holes	The wires are inserted into these holes.

Applicable Wires

Using Ferrules

If you use ferrules, attach the twisted wires to them.

Observe the application instructions for your ferrules for the wire stripping length when attaching ferrules.

Always use plated one-pin ferrules. Do not use unplated ferrules or two-pin ferrules.

The applicable ferrules, wires, and crimping tool are given in the following table.

Terminal types	Manufacturer	Ferrule model	Applicable wire (mm ² (AWG))	Crimping tool
Terminals other than ground terminals	Phoenix Contact	AI0,34-8	0.34 (#22)	Phoenix Contact (The figure in parentheses is the applicable wire size.) CRIMPFOX 6 (0.25 to 6 mm ² , AWG 24 to 10)
		AI0,5-8	0.5 (#20)	
		AI0,5-10		
		AI0,75-8	0.75 (#18)	
		AI0,75-10		
		AI1,0-8	1.0 (#18)	
		AI1,0-10		
		AI1,5-8	1.5 (#16)	
AI1,5-10				
Ground terminals		AI2,5-10	2.0 *1	
Terminals other than ground terminals	Weidmuller	H0.14/12	0.14 (#26)	Weidmuller (The figure in parentheses is the applicable wire size.) PZ6 Roto (0.14 to 6 mm ² , AWG 26 to 10)
		H0.25/12	0.25 (#24)	
		H0.34/12	0.34 (#22)	
		H0.5/14	0.5 (#20)	
		H0.5/16		
		H0.75/14	0.75 (#18)	
		H0.75/16		
		H1.0/14	1.0 (#18)	
		H1.0/16		
		H1.5/14	1.5 (#16)	
H1.5/16				

*1. Some AWG 14 wires exceed 2.0 mm² and cannot be used in the screwless clamping terminal block.

When you use any ferrules other than those in the above table, crimp them to the twisted wires so that the following processed dimensions are achieved.

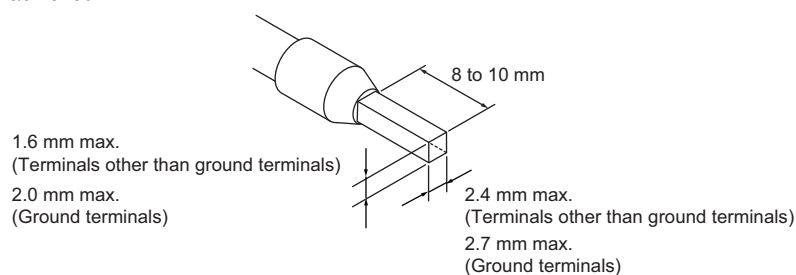

Using Twisted Wires/Solid Wires

If you use the twisted wires or the solid wires, use the following table to determine the correct wire specifications.

Terminals		Wire type				Wire size	Conductor length (stripping length)
		Twisted wires		Solid wire			
Classification	Current capacity	Plated	Unplated	Plated	Unplated		
All terminals except ground terminals	2 A max.	Possible	Possible	Possible	Possible	0.08 to 1.5 mm ² AWG28 to 16	8 to 10 mm
	Greater than 2 A and 4 A or less		Not Possible	Possible *1	Not Possible		
	Greater than 4 A		Possible *1	Not Possible	Not Possible		
Ground terminals	---	Possible	Possible	Possible *2	Possible *2	2.0 mm ²	9 to 10 mm

*1. Secure wires to the screwless clamping terminal block. Refer to the Securing Wires in the USER'S MANUAL for how to secure wires.

*2. With the NX-TB□□□1 Terminal Block, use twisted wires to connect the ground terminal. Do not use a solid wire.

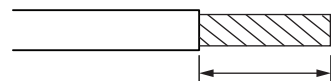

Conductor length (stripping length)

<Additional Information> If more than 2 A will flow on the wires, use plated wires or use ferrules.

Dimensions

● EtherCAT Coupler Unit Only

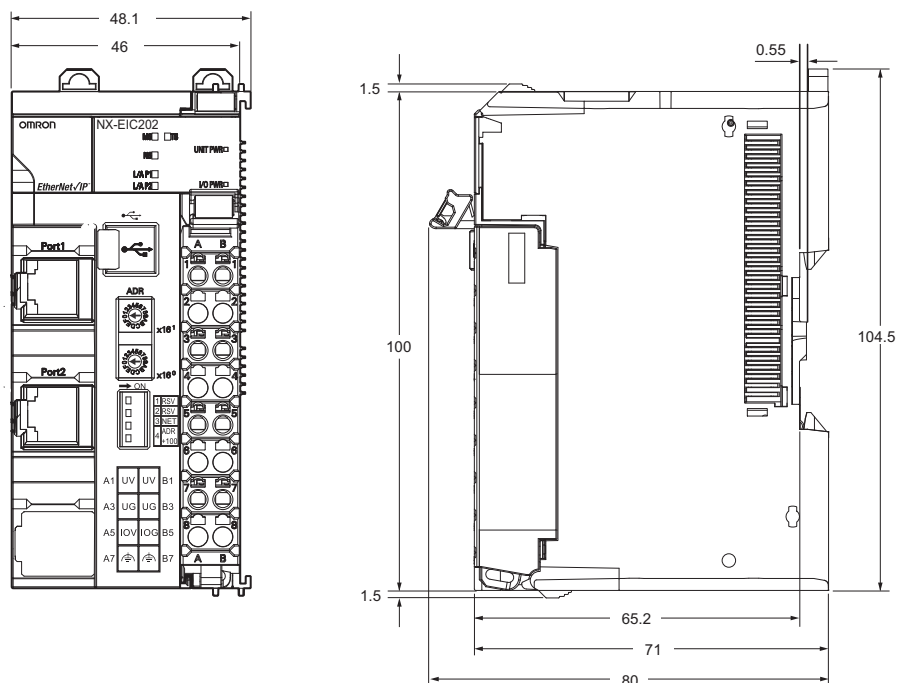

● With Cables Connected

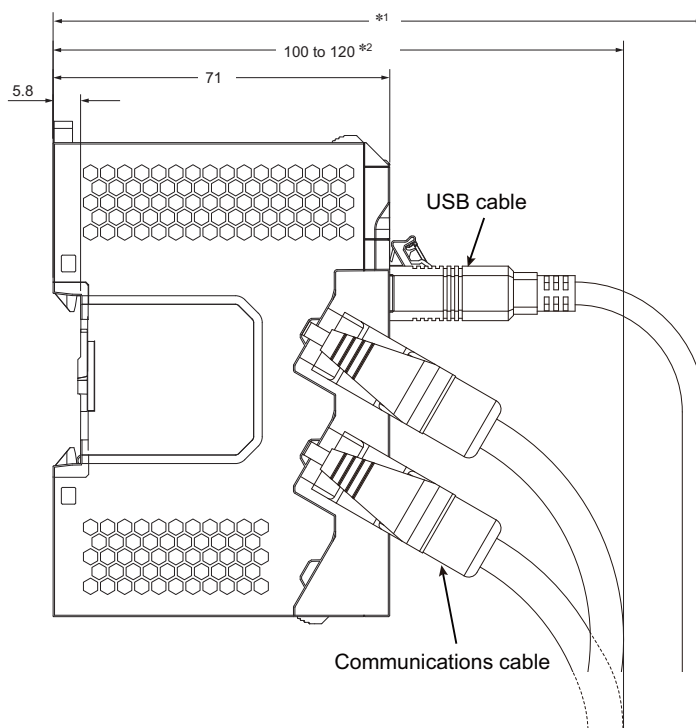

*1. This dimension depends on the specifications of the commercially available USB-certified cable. Check the specifications of the USB cable that is used.

*2. This is the dimension from the back of the Unit to the communications cables.

- 100 mm: When an MPS588-C Connector is used.
- 120 mm: When an XS6G-T421-1 Connector is used.

● End Cover

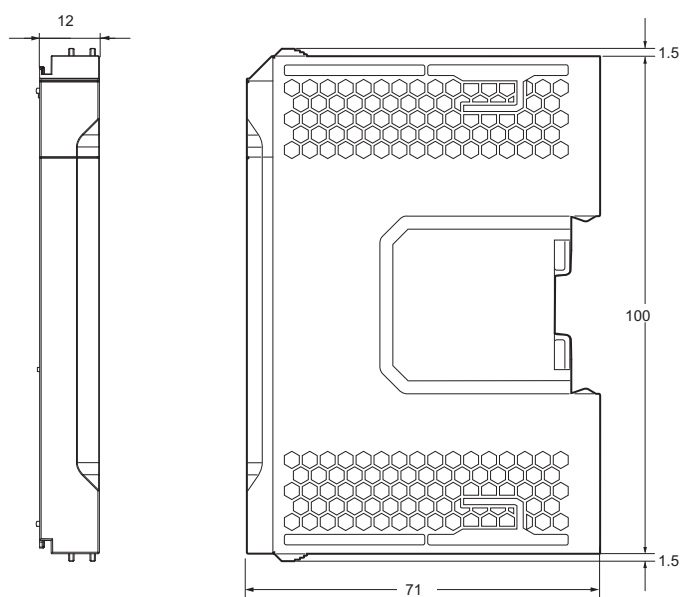

Related Manuals

Man. No	Model	Manual	Application	Description
W536	NX-EIC□□□	NX-series EtherNet/IP Coupler Unit User's Manual	Learning how to use an NX-series Ether-Net/IP Coupler Unit and EtherNet/IP Slave Terminals	Introduces the system, configuration methods, Unit hardware, setting methods, and functions of EtherNet/IP Slave Terminals that consist of an EtherNet/IP Coupler Unit and NX Units.

Terms and Conditions Agreement

Read and understand this catalog.

Please read and understand this catalog before purchasing the products. Please consult your OMRON representative if you have any questions or comments.

Warranties.

(a) Exclusive Warranty. Omron's exclusive warranty is that the Products will be free from defects in materials and workmanship for a period of twelve months from the date of sale by Omron (or such other period expressed in writing by Omron). Omron disclaims all other warranties, express or implied.

(b) Limitations. OMRON MAKES NO WARRANTY OR REPRESENTATION, EXPRESS OR IMPLIED, ABOUT NON-INFRINGEMENT, MERCHANTABILITY OR FITNESS FOR A PARTICULAR PURPOSE OF THE PRODUCTS. BUYER ACKNOWLEDGES THAT IT ALONE HAS DETERMINED THAT THE PRODUCTS WILL SUITABLY MEET THE REQUIREMENTS OF THEIR INTENDED USE.

Omron further disclaims all warranties and responsibility of any type for claims or expenses based on infringement by the Products or otherwise of any intellectual property right. (c) Buyer Remedy. Omron's sole obligation hereunder shall be, at Omron's election, to (i) replace (in the form originally shipped with Buyer responsible for labor charges for removal or replacement thereof) the non-complying Product, (ii) repair the non-complying Product, or (iii) repay or credit Buyer an amount equal to the purchase price of the non-complying Product; provided that in no event shall Omron be responsible for warranty, repair, indemnity or any other claims or expenses regarding the Products unless Omron's analysis confirms that the Products were properly handled, stored, installed and maintained and not subject to contamination, abuse, misuse or inappropriate modification. Return of any Products by Buyer must be approved in writing by Omron before shipment. Omron Companies shall not be liable for the suitability or unsuitability or the results from the use of Products in combination with any electrical or electronic components, circuits, system assemblies or any other materials or substances or environments. Any advice, recommendations or information given orally or in writing, are not to be construed as an amendment or addition to the above warranty.

See <http://www.omron.com/global/> or contact your Omron representative for published information.

Limitation on Liability: Etc.

OMRON COMPANIES SHALL NOT BE LIABLE FOR SPECIAL, INDIRECT, INCIDENTAL, OR CONSEQUENTIAL DAMAGES, LOSS OF PROFITS OR PRODUCTION OR COMMERCIAL LOSS IN ANY WAY CONNECTED WITH THE PRODUCTS, WHETHER SUCH CLAIM IS BASED IN CONTRACT, WARRANTY, NEGLIGENCE OR STRICT LIABILITY.

Further, in no event shall liability of Omron Companies exceed the individual price of the Product on which liability is asserted.

Suitability of Use.

Omron Companies shall not be responsible for conformity with any standards, codes or regulations which apply to the combination of the Product in the Buyer's application or use of the Product. At Buyer's request, Omron will provide applicable third party certification documents identifying ratings and limitations of use which apply to the Product. This information by itself is not sufficient for a complete determination of the suitability of the Product in combination with the end product, machine, system, or other application or use. Buyer shall be solely responsible for determining appropriateness of the particular Product with respect to Buyer's application, product or system. Buyer shall take application responsibility in all cases.

NEVER USE THE PRODUCT FOR AN APPLICATION INVOLVING SERIOUS RISK TO LIFE OR PROPERTY OR IN LARGE QUANTITIES WITHOUT ENSURING THAT THE SYSTEM AS A WHOLE HAS BEEN DESIGNED TO ADDRESS THE RISKS, AND THAT THE OMRON PRODUCT(S) IS PROPERLY RATED AND INSTALLED FOR THE INTENDED USE WITHIN THE OVERALL EQUIPMENT OR SYSTEM.

Programmable Products.

Omron Companies shall not be responsible for the user's programming of a programmable Product, or any consequence thereof.

Performance Data.

Data presented in Omron Company websites, catalogs and other materials is provided as a guide for the user in determining suitability and does not constitute a warranty. It may represent the result of Omron's test conditions, and the user must correlate it to actual application requirements. Actual performance is subject to the Omron's Warranty and Limitations of Liability.

Change in Specifications.

Product specifications and accessories may be changed at any time based on improvements and other reasons. It is our practice to change part numbers when published ratings or features are changed, or when significant construction changes are made. However, some specifications of the Product may be changed without any notice. When in doubt, special part numbers may be assigned to fix or establish key specifications for your application. Please consult with your Omron's representative at any time to confirm actual specifications of purchased Product.

Errors and Omissions.

Information presented by Omron Companies has been checked and is believed to be accurate; however, no responsibility is assumed for clerical, typographical or proofreading errors or omissions.