

M12 MALE ON REAR OF MSUD DOUBLE VALVE PLUG 10 MM

PUR 3X0.75 black UL/CSA, drag ch 0m

Form B (10 mm) – M12, connector at the rear

24 V AC $\pm 20\%$ / DC $\pm 25\%$

LED and suppression

Connection cable L = 200 mm

Plastic housings with good resistance against chemicals and oils.

The resistance to aggressive media should be individually tested for your application. Further details on request.

Link to Product

Illustration

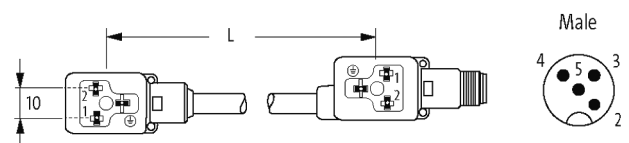
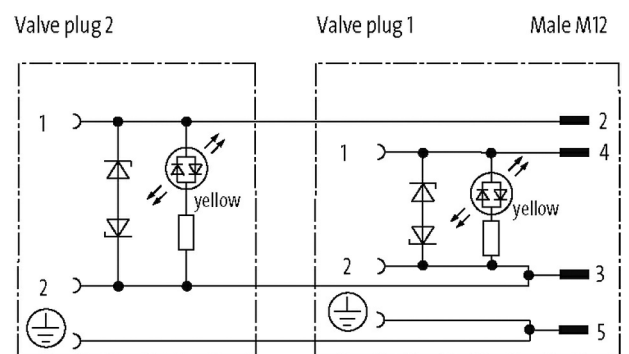
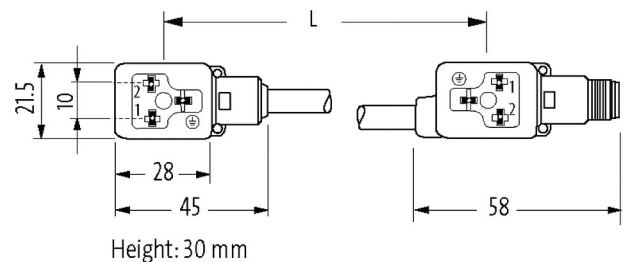
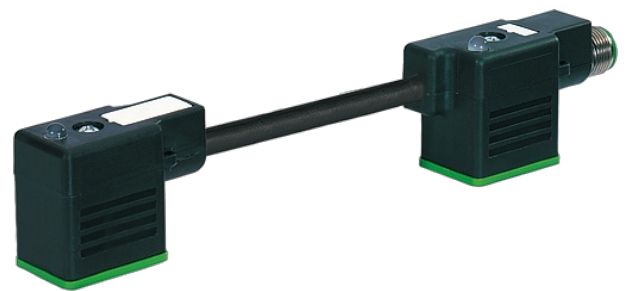

Product may differ from Image

Approvals

**Form**

Form 41721

Technical Data

Operating voltage	24 V AC $\pm 20\%$ / DC $\pm 25\%$
Operating current per contact	max. 4 A
Switch off peak	max. 55 V
Switch off delay time	max. 20 ms
LED display	(yellow)
Current consumption	approx. 12 mA
Housing	Black plastic (gray on request)
Locking of ports	M3 (recommended torque 0.4 Nm)
Protection	IP66K, IP67 inserted and tightened (EN 60529)

General data

Temperature range -25...+85 °C, depending on cable quality

Cables

No./diameter of wires	3 x 0.75 mm ²
Wire isolation	PP (bk num, gnye)
C-track properties	10 Mio.
Material (jacket)	PUR (UL/CSA)
Outer Ø	5.9 mm $\pm 5\%$
Bend radius (moving)	10 x outer Ø
Temperature range (fixed)	-40...+80 °C
Temperature range (mobile)	-25...+80 °C
Cable identification	636
Cable Type	3 (PUR)
Approval (cable)	cURus (AWM-Style 20549/10493); CE conform
Cable weight [g/m]	56,10
Material (wire)	Cu wire, bare
Resistor (core)	max. 26 Ω /km (20 °C)
Single wire Ø (core)	0.15 mm
Construction (core)	42 x 0.15 mm (multi-strand wire class 6)
Diameter (core)	3 x 0.75 mm ²
AWG	similar to AWG 18
Material (wire isolation)	PP
Material property (wire isolation)	CFC-, halogen-, cadmium-, silicone- and lead-free
Shore hardness (wire isolation)	70 ± 5 D
Wire-Ø incl. isolation	1.85 mm $\pm 5\%$
Color/numbering of wires	bk numbered, gnye longitudinally striped
Stranding combination	3 wires twisted
Shield	no
Material (jacket)	PUR
Material property (jacket)	CFC-, halogen-, cadmium-, silicone- and lead-free, matt, low-adhesion, machine easy to process, abrasion-resistant, hydrolysis and microbial resistant
Shore hardness (jacket)	90 ± 5 A

Outer-Ø (jacket)	5.9 mm ±5%
Color (jacket)	black
chemical resistance	good resistance to oil, gasoline and chemicals (EN 60811-404)
thermal resistance	flame retardand UL 1581 Section 1090 (H), CSA FT2 / IEC 60332-2-2
Nominal voltage	300 V AC
Test voltage	2500 V AC
Current load capacity	to DIN VDE 0298-4
Temperature range (fixed)	-40...+80 °C, (+90 °C at max. 10 000 operating hours)
Temperature range (mobile)	-25...+80 °C, (+90 °C at max. 10 000 operating hours)
Bend radius (fixed)	5× outer Ø
Bend radius (moving)	10× outer Ø
No. of bending cycles (C-track)	max. 10 Mio. (25 °C)
Travel speed (C-track)	max. 3 m/s
Acceleration (C-track)	max. 10 m/s ²
Torsion stress	±180°/m
No. of torsion cycles	max. 2 Mio. (25 °C)
Torsion speed	35 cycles/min
Jacket Color	black

Commercial data

country of origin	CZ
customs tariff number	85444290
EAN	4048879143844
eClass	27143423
Packaging unit	1