

**M12 male 0° / M8 female 90° LED**

PUR 3x0.25 ye UL/CSA+robot+drag chain 0,3m

Male straight – female 90°

M12 – M8, 3-pole

LED (yellow/green)

Plastic housings with good resistance against chemicals and oils.

The resistance to aggressive media should be individually tested for your application. Further details on request.

Further cable lengths on request.

Zinc die casting, save-cover coated

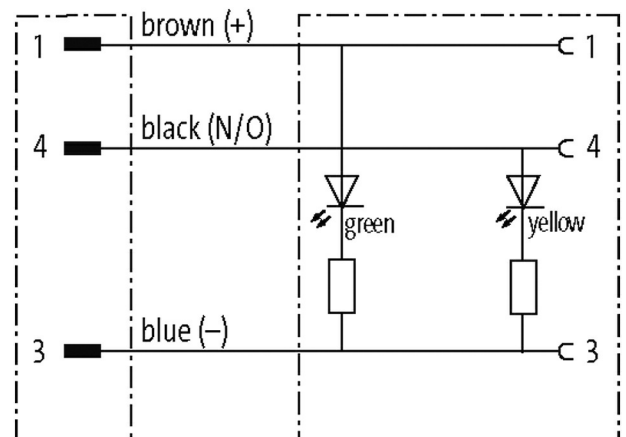
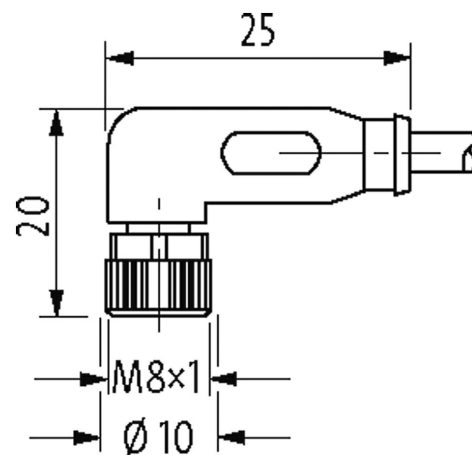
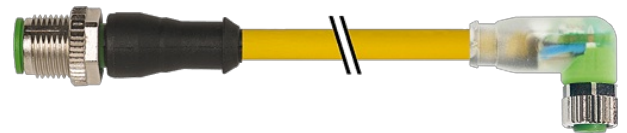
**[Link to Product](#)****Illustration**

Product may differ from Image

**Approvals**

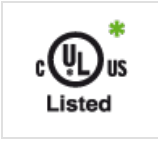

\* only for products with UL/CSA approved cable

**Form**

Form 40641

**Technical Data**

Operating voltage	24 V DC $\pm$ 25%
Operating voltage (only UL listed)	30 V DC
Rated surge voltage	0.8 kV
Operating current per contact	max. 4 A
No. of poles	3
Current consumption	5 mA
Material group	IEC 60664-1, category I
Coding	M12, A-coded
LED display	(yellow/green)
Locking of ports	Screw thread (M8/M12 $\times$ 1 mm) recommended torque 0.4/0.6 Nm, self-securing
Compression gland	M8 (SW9), M12 (SW13)
Protection	IP66K, IP67 inserted and tightened (EN 60529)
Material	PUR
suitable for corrugated tube (internal $\varnothing$ )	M12 (10 mm); M8 (6.5 mm)
Locking material	Zinc die casting, save-cover coated

**General data**

Standards	DIN EN 61076-2-101 (M12), DIN EN 61076-2-104 (M8)
Material (contact)	Copper alloy
Material (contact surface)	Au
Material (gasket)	FKM
Pollution Degree	3
Temperature range	-25...+85 °C, depending on cable quality

**Cables**

No./diameter of wires	3 $\times$ 0.25 mm <sup>2</sup>
Wire isolation	PP (br, bl, bk)
C-track properties	10 Mio.
Material (jacket)	PUR (UL/CSA), welding spark
Outer $\varnothing$	4.3 mm $\pm$ 5%
Bend radius (moving)	10 $\times$ outer $\varnothing$
Temperature range (fixed)	-40...+80 °C
Temperature range (mobile)	-25...+80 °C
Cable identification	050
Cable Type	5 (PUR schweißfunkenbeständig)
Approval (cable)	cURus (AWM-Style 20549/10493); CE conform
Cable weight [g/m]	26,40
Material (wire)	Cu wire, bare
Resistor (core)	max. 79 $\Omega$ /km (20 °C)
Single wire $\varnothing$ (core)	0.1 mm
Construction (core)	32 $\times$ 0.1 mm (multi-strand wire class 6)
Diameter (core)	3 $\times$ 0.25 mm <sup>2</sup>

AWG	similar to AWG 24
Material (wire isolation)	PP
Material property (wire isolation)	CFC-, halogen-, cadmium-, silicone- and lead-free
Shore hardness (wire isolation)	74 ±3 D
Wire-Ø incl. isolation	1.25 mm ±5%
Color/numbering of wires	br, bk, bl
Stranding combination	3 wires twisted
Shield	no
Material (jacket)	PUR
Material property (jacket)	CFC-, halogen-, cadmium-, silicone- and lead-free, matt, low-adhesion, machine easy to process, abrasion-resistant, hydrolysis-, microbial- and welding spark resistant
Shore hardness (jacket)	58 ±3 D
Outer-Ø (jacket)	4.3 mm ±5%
Color (jacket)	yellow
chemical resistance	good resistance to oil, gasoline and chemicals (EN 60811-404)
thermal resistance	flame retardant UL, FT2, IEC 60332-1, IEC 60332-2-2, welding spark resistant
Nominal voltage	300 V AC
Test voltage	2500 V AC
Current load capacity	to DIN VDE 0298-4
Temperature range (fixed)	-40...+80 °C, (+90 °C at max. 10 000 operating hours)
Temperature range (mobile)	-25...+80 °C, (+90 °C at max. 10 000 operating hours)
Bend radius (fixed)	5× outer Ø
Bend radius (moving)	10× outer Ø
No. of bending cycles (C-track)	max. 10 Mio. (25 °C)
Traversing distance (C-track)	max. 5 m (horizontal)
Travel speed (C-track)	max. 3.3 m/s
Acceleration (C-track)	max. 5 m/s <sup>2</sup>
Torsion stress	±360°/m
No. of torsion cycles	max. 1 Mio. (25 °C)
Torsion speed	35 cycles/min
Jacket Color	yellow

**Commercial data**

country of origin	DE
customs tariff number	85444290
EAN	4048879159852
eClass	27279218
Packaging unit	1

**Sketch**

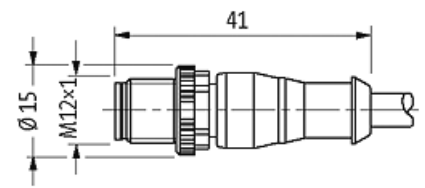

Male

Female

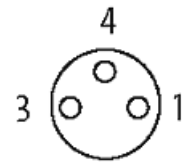
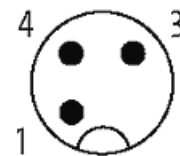

Product may differ from Image