

M12 female 0° shielded B-cod. with cable, Profibus

PUR 1x2xAWG23 shielded vt torsion UL/CSA 3m

PROFIBUS

Female straight

M12, 2-pole

B-coded

shielded

Plastic housings with good resistance against chemicals and oils.

The resistance to aggressive media should be individually tested for your application. Further details on request.

Further cable lengths on request.

[Link to Product](#)

Illustration

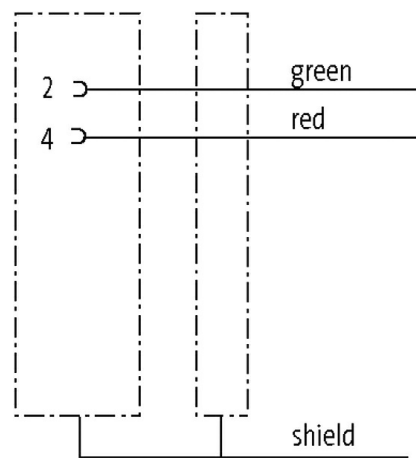
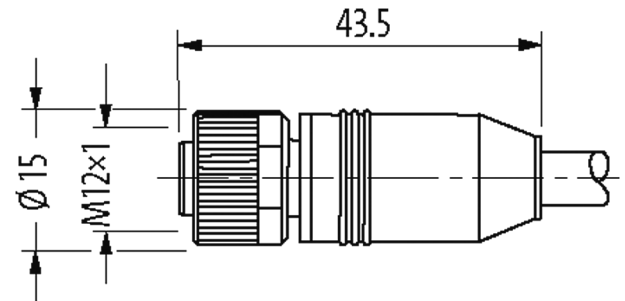
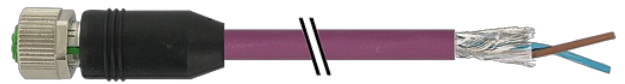

Female

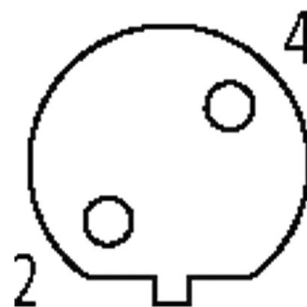

Product may differ from Image

Approvals

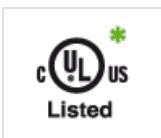

* only for products with UL/CSA approved cable

cCSAus

More Info



Form	
Form	14061
Technical Data	
Operating voltage	max. 60 V AC/DC
Operating voltage (only UL listed)	max. 30 V AC/DC
Rated surge voltage	1.5 kV
Operating current per contact	max. 4 A
Material group	IEC 60664-1, category I
Coding	B-coded
Locking of ports	Screw thread (M12×1 mm) recommended torque 0.6 Nm, self-securing
Compression gland	M12 (SW13)
Protection	IP65, IP66K, IP67 inserted and tightened (EN 60529)
Locking material	Zinc die casting, matte nickel plated
Material	PUR
General data	
Standards	DIN EN 61076-2-101 (M12)
Pollution Degree	3
Stripping length (jacket)	20 mm
Temperature range	-25...+85 °C, depending on cable quality
Cables	
No./diameter of wires	1 × 2 × 0.25 mm ²
Wire isolation	PE (rd, gn)
Jacket Color	violet
Material (jacket)	PUR (UL/CSA)
Outer Ø	8.0 mm ±5%
Bend radius (moving)	12 × outer Ø
Temperature range (fixed)	-40...+80 °C
Temperature range (mobile)	-20...+50 °C
Cable identification	843
Approval (cable)	UL (AWM-Style 20233/10578), CSA; CE
Cable weight [g/m]	79,20
Material (wire)	Cu wire, bare
Resistor (core)	max. 66 Ω/km (20 °C)
Single wire Ø (core)	0.15 mm
Construction (core)	19 × 0.15 mm (multi-strand wire class 5)
Diameter (core)	1 × 2 × 0.25 mm ²
Wire-Ø incl. isolation	2.6 mm ±5%
Color/numbering of wires	rd, gn
Shield	yes
Material (jacket)	PUR
Outer-Ø (jacket)	8.0 mm ±5%
Color (jacket)	violet
thermal resistance	flame retardant
Nominal voltage	300 V

Temperature range (fixed)	-40...+80 °C
Temperature range (mobile)	-20...+50 °C
Bend radius (fixed)	8× outer Ø
Bend radius (moving)	12× outer Ø
Torsion stress	±180°/m

Commercial data

country of origin	DE
customs tariff number	85444290
EAN	4048879478380
eClass	27061801
Packaging unit	1