

DEMAGNETIZER 1,5 A

INPUT: 24 V DC

OUTPUT: 24 V DC

max. 1.5 A (short-circuit protected)

Screw terminals

[Link to Product](#)

Illustration

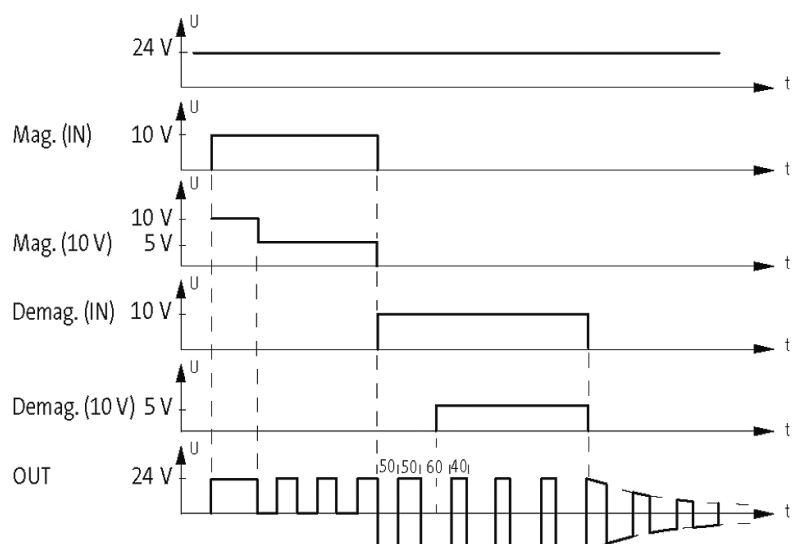

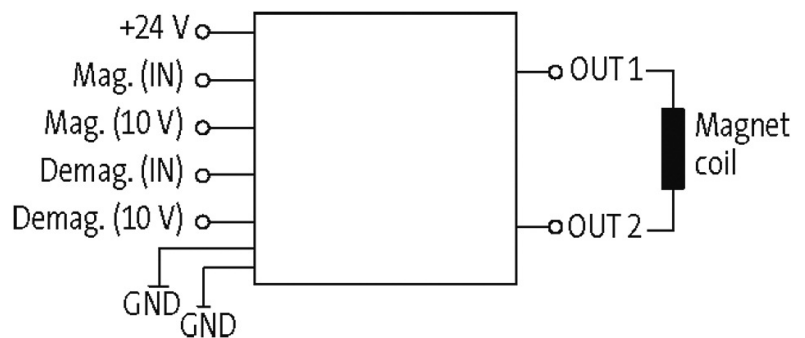
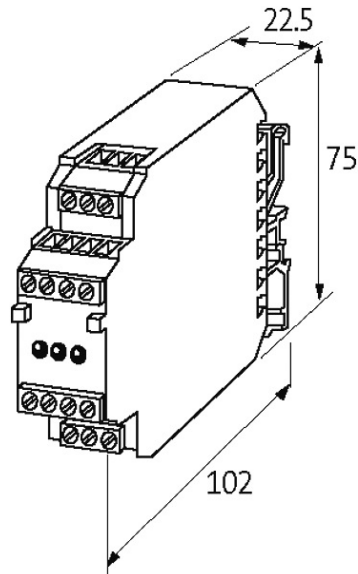

Product may differ from image

Input

Input resistor	approx. 10 k Ω
Magnetization (digital)	safe OFF: max. 1V; safe ON: min. 5V (LED yellow)
Magnetization (analog)	0.8...8.8 V (0...100%)
Demagnetization (digital)	safe OFF: max. 1V; safe ON: min. 5V (LED yellow)
Demagnetization (analog)	0...10 V (44...55%)

Technical Data

Operating voltage	24 V DC (18...30 V DC)
Operating current	approx. 40 mA
LED display	LED (green)
Invers-polarity protection	yes

General data

Protection	IP20
Mounting method	DIN-rail mountable (EN 60715)
Connection	Screw terminals
Temperature range	-25...+50 °C (storage temperature -40...+80 °C)
Dimensions H x W x D	75x22.5x102 mm

Output

The information in this brochure has been compiled with the utmost care.

Liability for the correctness completeness and topicality of the information is restricted to gross negligence. Version: 04/19

Output voltage	24 V DC
Output current	max. 1.5 A (short-circuit protected)
PWM frequency	approx. 800 Hz
Commercial data	
country of origin	CZ
customs tariff number	85437090
EAN	4048879025058
eClass	27210990
Packaging unit	1