

PASSIVE-DI0° PLASTIC,6XM12,5POL,PRE-WIRED CABLE

3.0m PUR-JB 12*0,34+3*0,75

6-way, 5-pole

PUR/PVC

3.0 m

with LED for digital PNP-signals 24 V DC

Further cable lengths on request. Plastic housings with good resistance against chemicals and oils. The resistance to aggressive media should be individually tested for your application. Further details on request.

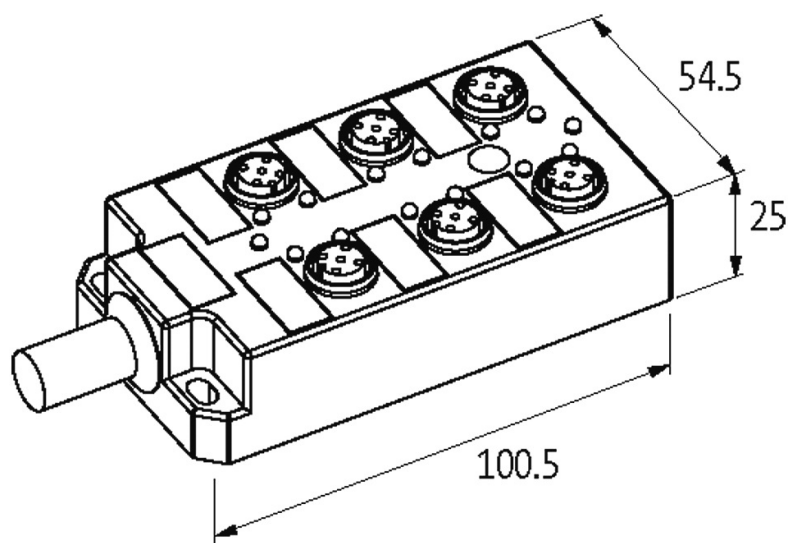
[Link to Product](#)**Illustration**

M12 Females 5-pole

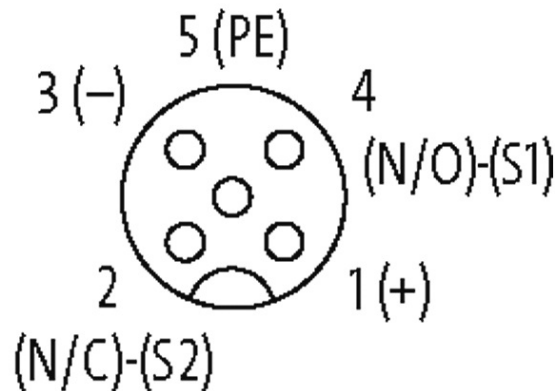

Product may differ from Image

Contact Layout

PIN 1	(+)
PIN 2	(NC)/(S2)
PIN 3	(-)
PIN 4	(NO)/(S1)
PIN 5	(Earth)
LED display	LED (green): Power / LED (yellow): (S1/S2)

Cables

Cable number	388
No./diameter of wires	12×0.34 + 3×0.75 mm ²
Wire isolation	PVC (yebr, rd, grpk, wh, rdbl, gn, whgn, ye, brgn, gr, whye, pk, br, gnye, bl)
C-track properties	2 Mio.
Jacket Color	gray
Material (jacket)	PUR/PVC
Outer Ø	9.8 mm ±5%
Bend radius (fixed)	10 × outer Ø
Bend radius (moving)	12 × outer Ø
Temperature range (fixed)	-30...+80 °C
Temperature range (mobile)	-5...+70 °C
Color (jacket)	gray

Technical Data

Operating voltage	24 V DC
Signal per port	2
Operating current per contact	max. 4 A
Total current	max. 10 A
Locking of ports	Screw thread M12 × 1 mm

General data

Dimensions H x W x D	100.5x54.5x25 mm
Protection	IP67 inserted and tightened (EN 60529)
Temperature range	-20...+80 °C

Commercial data

country of origin	CZ
customs tariff number	85444290
EAN	4048879062978
eClass	27279219
Packaging unit	1