



■ Features :

- Universal AC input / Full range (up to 295VAC)
- Protections: Short circuit / Over current / Over voltage / Over temperature
- Cooling by free air convection
- Built-in constant current limiting circuit with adjustable OCP level
- Fully isolated plastic case with IP64 level
- Built-in active PFC function
- Pass LPS
- Class II power unit, no FG
- Class 2 power unit
- 100% full load burn-in test
- High reliability
- Suitable for LED lighting and moving sign applications (Note.2)
- Compliance to worldwide safety regulations for lighting
- 2 years warranty



SPECIFICATION

| MODEL | PLN-30-9 | PLN-30-12 | PLN-30-15 | PLN-30-20 | PLN-30-24 | PLN-30-27 | PLN-30-36 | PLN-30-48 | |
|-----------------|--|--|-----------|--------------|-----------|--------------|------------|------------|------------|
| OUTPUT | DC VOLTAGE | 9V | 12V | 15V | 20V | 24V | 27V | 36V | 48V |
| | CONSTANT CURRENT REGION Note.6 | 6.3 ~ 9V | 8.4 ~ 12V | 10.5 ~ 15V | 14 ~ 20V | 16.8 ~ 24V | 18.9 ~ 27V | 25.2 ~ 36V | 33.6 ~ 48V |
| | RATED CURRENT | 3.3A | 2.5A | 2A | 1.5A | 1.25A | 1.12A | 0.84A | 0.63A |
| | CURRENT RANGE | 0 ~ 3.3A | 0 ~ 2.5A | 0 ~ 2A | 0 ~ 1.5A | 0 ~ 1.25A | 0 ~ 1.12A | 0 ~ 0.84A | 0 ~ 0.63A |
| | RATED POWER | 29.7W | 30W | 30W | 30W | 30W | 30.24W | 30.24W | 30.24W |
| | RIPPLE & NOISE (max.) Note.2 | 2.6Vp-p | 2Vp-p | 2.6Vp-p | 2.6Vp-p | 2.6Vp-p | 2.3Vp-p | 4.5Vp-p | 3.7Vp-p |
| | VOLTAGE ADJ. RANGE Note.5 | -5% ~ 10%. Can be adjusted by internal potentiometer SVR1 | | | | | | | |
| | CURRENT ADJ. RANGE Note.5 | 3% ~ -25%. Can be adjusted by internal potentiometer SVR2 | | | | | | | |
| | VOLTAGE TOLERANCE Note.3 | ±10% | | | | | | | |
| | LINE REGULATION | ±3.0% | | | | | | | |
| LOAD REGULATION | ±5.0% | | | | | | | | |
| SETUP TIME | 500ms / 230VAC 3000ms / 115VAC at full load | | | | | | | | |
| INPUT | VOLTAGE RANGE Note.4 | 90 ~ 295VAC | | 127 ~ 417VDC | | | | | |
| | FREQUENCY RANGE | 47 ~ 63Hz | | | | | | | |
| | POWER FACTOR (Typ.) | PF>0.95/115VAC, PF>0.9/230VAC, PF>0.9/277VAC at full load (Please refer to "Power Factor Characteristic" curve) | | | | | | | |
| | TOTAL HARMONIC DISTORTION | THD< 20% when output loading≥75% at 115VAC/230VAC input and output loading≥80% at 277VAC input | | | | | | | |
| | EFFICIENCY (Typ.) | 80% | 82.5% | 83.5% | 84% | 84% | 84.5% | 85% | 85.5% |
| | AC CURRENT (Typ.) | 0.4A/115VAC | | 0.2A/230VAC | | 0.15A/277VAC | | | |
| | INRUSH CURRENT (Typ.) | COLD START 35A(twidth=25μs measured at 50% Ipeak) at 230VAC | | | | | | | |
| | MAX. No. of PSUs on 16A CIRCUIT BREAKER | 64 units (circuit breaker of type B) / 64 units (circuit breaker of type C) at 230VAC | | | | | | | |
| | LEAKAGE CURRENT | <0.5mA / 240VAC | | | | | | | |
| PROTECTION | OVER CURRENT | 100 ~ 110% Protection type : Constant current limiting, recovers automatically after fault condition is removed | | | | | | | |
| | SHORT CIRCUIT | Hiccup mode, recovers automatically after fault condition is removed. | | | | | | | |
| | OVER VOLTAGE | 10 ~ 14V | 14 ~ 17V | 17 ~ 22V | 23 ~ 26V | 27 ~ 34V | 31 ~ 35V | 40 ~ 50V | 53 ~ 63V |
| | OVER TEMPERATURE | Shut down o/p voltage, re-power on to recover | | | | | | | |
| ENVIRONMENT | WORKING TEMP. | -30 ~ +50°C (Refer to "Derating Curve") | | | | | | | |
| | WORKING HUMIDITY | 20 ~ 95% RH non-condensing | | | | | | | |
| | STORAGE TEMP., HUMIDITY | -40 ~ +80°C, 10 ~ 95% RH | | | | | | | |
| | TEMP. COEFFICIENT | ±0.06%/°C (0 ~ 50°C) | | | | | | | |
| | VIBRATION | 10 ~ 500Hz, 2G 12min./1cycle, period for 72min. each along X, Y, Z axes | | | | | | | |
| SAFETY & EMC | SAFETY STANDARDS | UL879, UL1310, CSA C22.2 No. 207-M89(except for 48V), TUV EN61347-1, EN61347-2-13, CAN/CSA C22.2 No.223-M91 (except for 48V),IP64, J61347-1,J61347-2-13 approved | | | | | | | |
| | WITHSTAND VOLTAGE | I/P-O/P:3.75KVAC | | | | | | | |
| | ISOLATION RESISTANCE | I/P-O/P:100M Ohms / 500VDC / 25°C/ 70% RH | | | | | | | |
| | EMC EMISSION | Compliance to EN55015, EN61000-3-2 Class C (pin≥25W), Class D (>70% load) ; EN61000-3-3 | | | | | | | |
| | EMC IMMUNITY | Compliance to EN61000-4-2,3,4,5,6,8,11, EN55024, EN61547, light industry level, criteria B | | | | | | | |
| OTHERS | MTBF | 621.4Khrs min. MIL-HDBK-217F (25°C) | | | | | | | |
| | DIMENSION | 145*47*30mm (L*W*H) | | | | | | | |
| | PACKING | 0.22Kg; 60pcs/14.2Kg/1.25CUFT | | | | | | | |
| NOTE | <ol style="list-style-type: none"> All parameters NOT specially mentioned are measured at 230VAC input, rated load and 25°C of ambient temperature. Ripple & noise are measured at 20MHz of bandwidth by using a 12" twisted pair-wire terminated with a 0.1uf & 47uf parallel capacitor. Tolerance : includes set up tolerance, line regulation and load regulation. Derating may be needed under low input voltage. Please check the static characteristics for more details. Output voltage can be adjusted through the SVR1 on the PCB; limit of output constant current level can be adjusted through the SVR2 on the PCB. Please refer to "DRIVING METHODS OF LED MODULE". The power supply is considered as a component that will be operated in combination with final equipment. Since EMC performance will be affected by the complete installation, the final equipment manufacturers must re-qualify EMC Directive on the complete installation again. Direct connecting to LEDs is suggested, but is not suitable for using additional drivers. To fulfill requirements of the latest ErP regulation for lighting fixtures, this LED power supply can only be used behind a switch without permanently connected to the mains. | | | | | | | | |

Mechanical Specification

Case No.964A Unit:mm

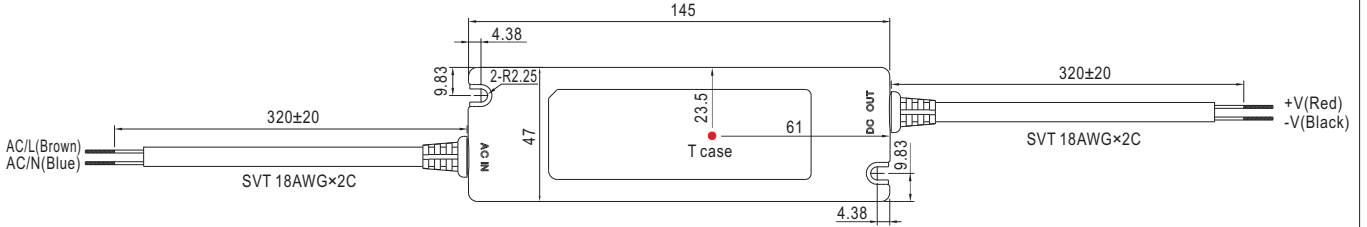

※ T case: Max. Case Temperature.



Output voltage and current adjustment : remove the upper case and adjust through SVR1 & SVR2 shown in the diagram.

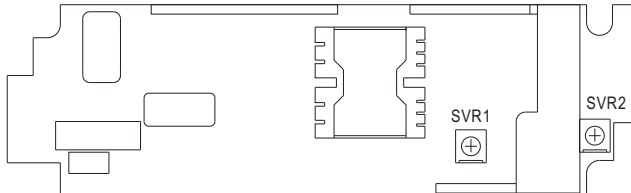

| | |
|------|---------------------------|
| SVR1 | Output voltage adjustment |
| SVR2 | Output current adjustment |

Block Diagram

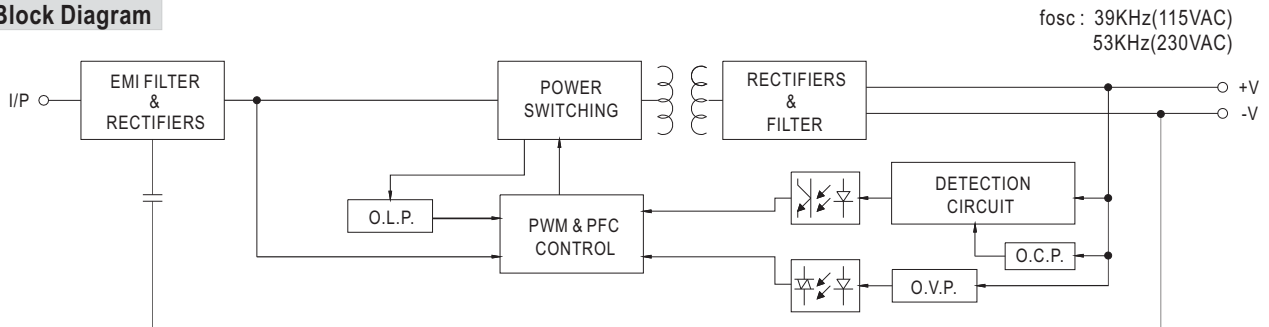

Derating Curve

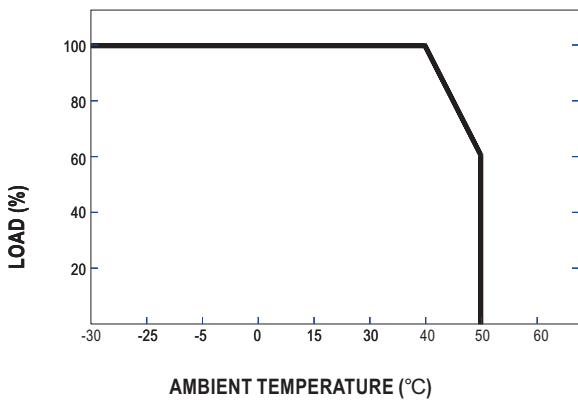

Static Characteristics

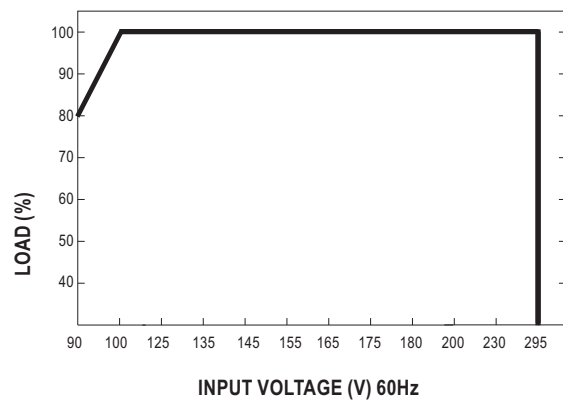

Power Factor Characteristic

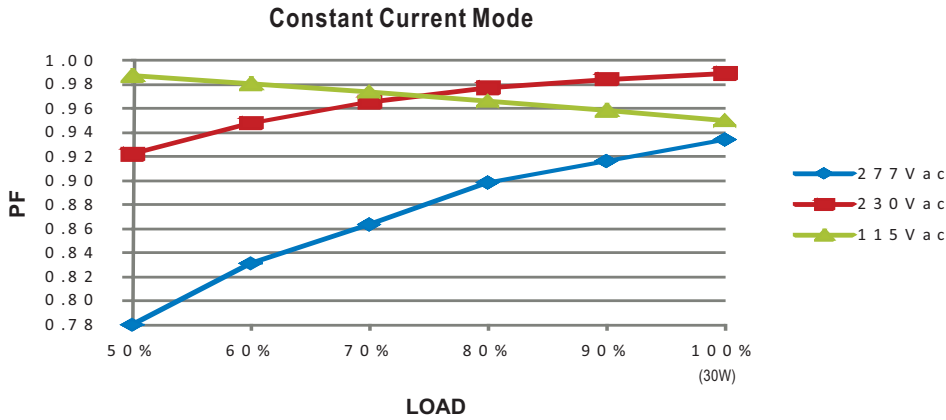

EFFICIENCY vs LOAD (48V Model)

PLN-30 series possess superior working efficiency that up to 85.5% can be reached in field applications.

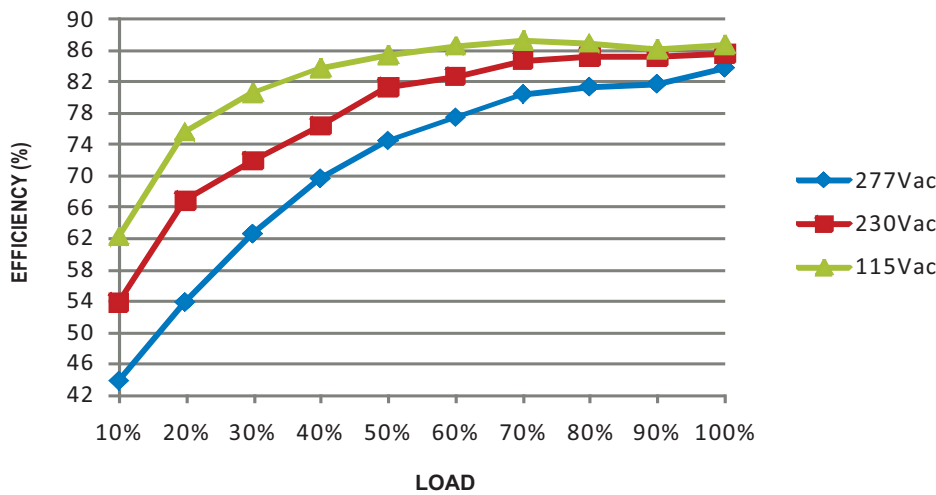

DRIVING METHODS OF LED MODULE

This LED power supply is suggested to work in constant current mode area (CC) to drive the LEDs.

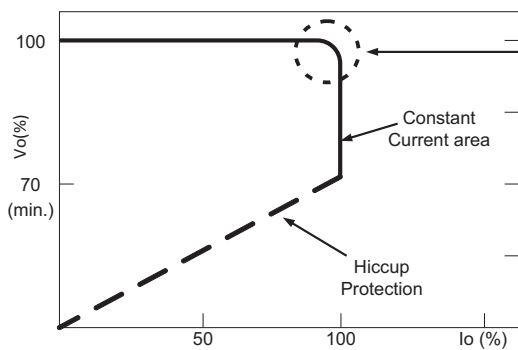

Typical LED power supply I-V curve

In the constant current region, the highest voltage at the output of the driver depends on the configuration of the end systems. Should there be any compatibility issues, please contact MEAN WELL.