

## SILVYN® BW-K-M

SILVYN® BW-K-M is a mounting bracket made of plastic

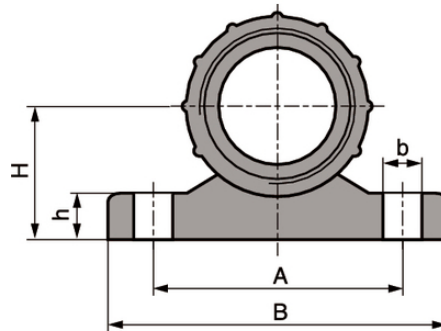

Space requirement

### Benefits

Space-saving

### Application range

Mechanical engineering

Plant engineering

Control cabinet manufacturing

Used in areas where SILVYN® protective conduits cannot be inserted into a machine or an appliance

### Product Make-up

Plastic fixing bracket

2 x bore hole for fixation

### Technical Data

Classification ETIM 5:

ETIM 5.0 Class-ID: EC001458

ETIM 5.0 Class-Description: Fastening angle for hose fitting

Classification ETIM 6:

ETIM 6.0 Class-ID: EC001458

ETIM 6.0 Class-Description: Fastening angle for hose fitting

Colour delivered:

Grey, RAL 7001

Material:

PP

Temperature range:

-40°C to +100°C

### Note

Photographs and graphics are not to scale and do not represent detailed images of the respective products.

Prices are net prices without VAT and surcharges. Sale to business customers only.

**SILVYN® BW-K-M**

Article number	Metric size	A (mm)	B in mm	Pieces / PU
SILVYN® BW-K-M				
55000911	20 x 1.5	37.5	50	50
55000921	25 x 1.5	43	57	50
55000931	32 x 1.5	53.5	67	50
55000941	40 x 1.5	65.5	79.5	50
55000951	50 x 1.5	69.5	86	50

Last Update (04.02.2022)

©2022 Lapp Group - Technical changes reserved

Product Management [www.lappkabel.de](http://www.lappkabel.de)

You can find the current technical data in the corresponding data sheet.

PN 0456 / 02\_03\_16