

EPIC® QUICK & EASY Mounting system

The installation system for control cabinets is available as a set or as single components (upper part for the cable connector, lower part for installation to DIN rail).

Info

Mounting system for control cabinets

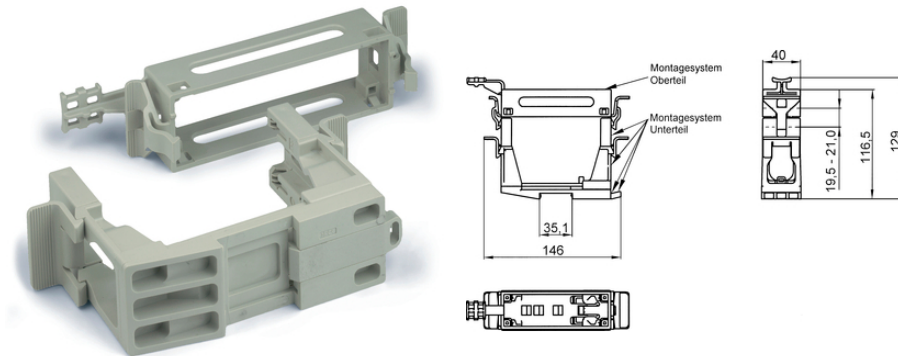

Application range

Control cabinet manufacturing

Product features

For mounting inserts on top-hat rails according to DIN EN 50022

Available as a complete set or as single parts (top part for use as a cable connector, bottom part for mounting on a top-hat rail)
 QUICK & EASY top parts are available in housing types H-B 6, H-B 10, H-B 16, H-B 24. The suitable size (number of contacts) of the different insert types are listed at the connector housings (H-B 6 ..H-B 24)

Technical Data

Classification ETIM 5:	ETIM 5.0 Class-ID: EC002312 ETIM 5.0 Class-Description: Contact insert holder for industrial connectors
Classification ETIM 6:	ETIM 6.0 Class-ID: EC002312 ETIM 6.0 Class-Description: Contact insert holder for industrial connectors
Flammability:	UL94 V-0
Cycle of mechanical operation:	50

Note

Photographs and graphics are not to scale and do not represent detailed images of the respective products.
 Prices are net prices without VAT and surcharges. Sale to business customers only.

EPIC® QUICK & EASY Mounting system

Article number	Article description	Material	Version	Pieces / PU
QUICK & EASY complete set				
10027000	EPIC® H-B 6 Q+E Set	Polycarbonate	Complete, for inserts size H-B 6	1
10027100	EPIC® H-B 10 Q+E Set	Polycarbonate	Complete, for inserts size H-B 10	1
10027200	EPIC® H-B 16 Q+E Set	Polycarbonate	Complete, for inserts size H-B 16	1
10027300	EPIC® H-B 24 Q+E Set	Polycarbonate	Complete, for inserts size H-B 24	1
QUICK & EASY top part				
10027410	EPIC® H-B 6 Q+E top part	Polycarbonate	For inserts size H-B 6	10
10027510	EPIC® H-B 10 Q+E top part	Polycarbonate	For inserts size H-B 10	10
10027610	EPIC® H-B 16 Q+E top part	Polycarbonate	For inserts size H-B 16	10
10027710	EPIC® H-B 24 Q+E top part	Polycarbonate	For inserts size H-B 24	10
QUICK & EASY bottom part				
10027810	EPIC® H-B 6-24 Q+E bottom part	Polycarbonate	For inserts size H-B 6 - 24	10

Last Update (31.07.2021)

©2021 Lapp Group - Technical changes reserved

Product Management www.lappkabel.de

You can find the current technical data in the corresponding data sheet.
PN 0456 / 02_03_16