

DATASHEET - SL-F800

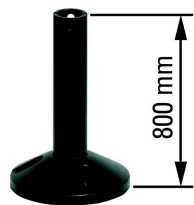

Stand, with tube 800mm

Part no. SL-F800
Catalog No. 215276
Alternate Catalog No. SL-F800



Delivery program

Product range			SL signal towers
Single unit/Complete unit			Stand-alone device
Length		mm	800
Material			Metal
Connection to SmartWire-DT			no

Design verification as per IEC/EN 61439

Technical data for design verification			
Operating ambient temperature min.		°C	-25
Operating ambient temperature max.		°C	55

Technical data ETIM 5.0

Low-voltage industrial components (EG000017) / Stand for signal tower with tube (EC001259)			
Electric engineering, automation, process control engineering / Low-voltage switch technology / Command and alarm device / Signal column element, foot with pipe (ecl@ss8-27-37-12-34 [AKF052010])			
Colour			Black
Tube length		mm	800
Material			Metal

Approvals

Product Standards			IEC/EN 60947-5; UL 508; CSA-C22.2 No. 14-05; CSA-C22.2 No. 94-91; CE marking
UL File No.			E29184
UL Category Control No.			NKCR
CSA File No.			012528
CSA Class No.			3211-03
North America Certification			UL listed, CSA certified

Dimensions

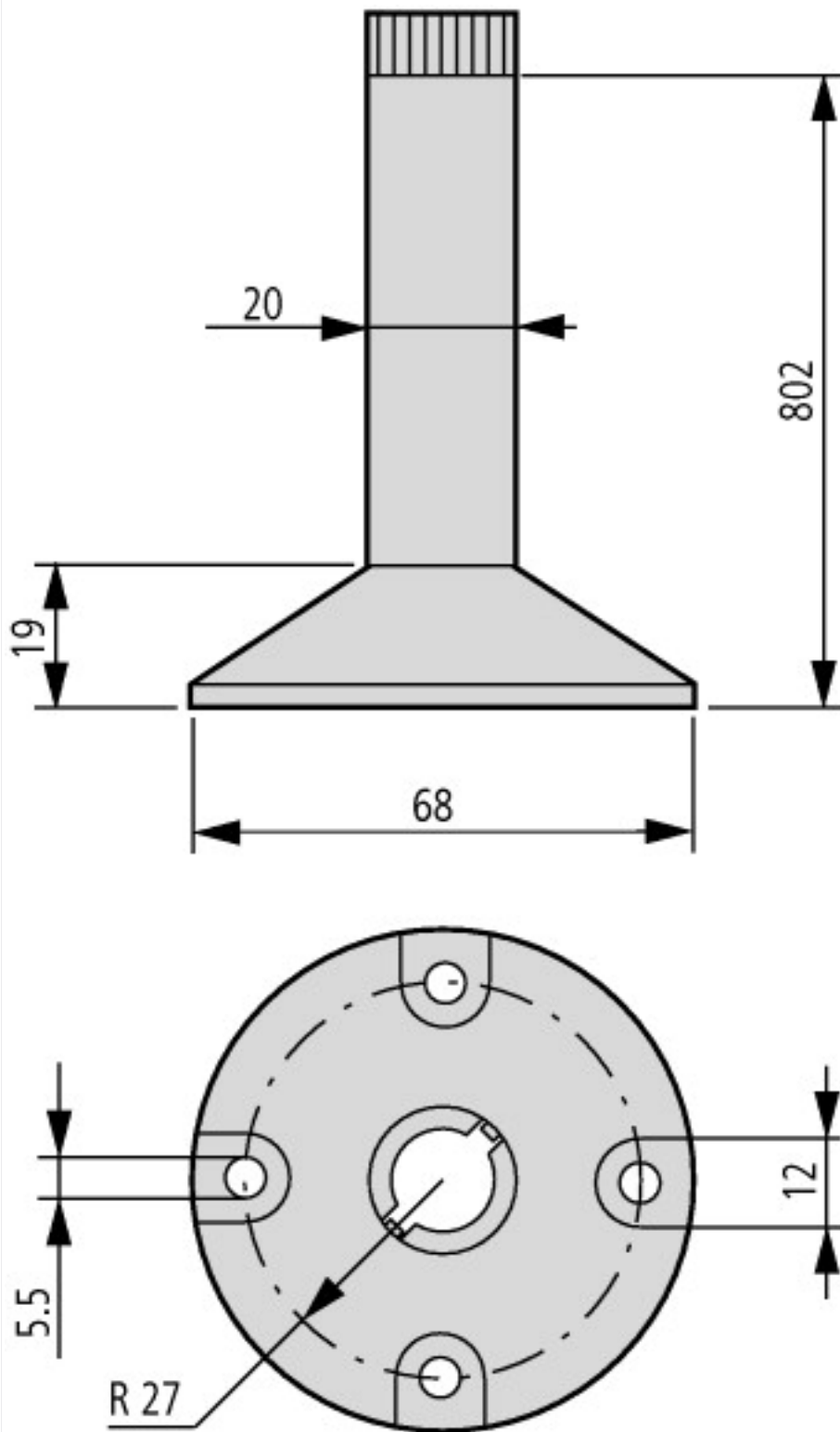

Additional product information (links)

IL04716024Z (AWA1160-1685) Pillar lamps

IL04716024Z (AWA1160-1685) Pillar lamps

https://es-assets.eaton.com/DOCUMENTATION/AWA_INSTRUCTIONS/IL04716024Z2018_05.pdf