



Control transformer, 0.25 kVA, Rated input voltage 400± 5 % V, Rated output voltage 230 V

Part no. STN0,25(400/230)
Catalog No. 204980
Alternate Catalog No. STNP25-I2-G2

Delivery program

Product range		Single-phase control transformers ST...
Basic function		Single-phase STN control transformers
Rated input voltage	V	400± 5 %
Rated output voltage	V	230
Rated power	kVA	0.25
Short-time rating	kVA	0.44
Terminal diagram / contact assignment		
Cu factor 0,65		

Technical data

General

Standards			
Built and tested to			IEC/EN 61558-2-2 VDE 0570 Part 2-2
Suitable for use to			IEC/EN 60204-1, ÖVE-EN 13 VDE 0113, VDE 0100 Part 410
Ambient temperature			-25 - 40

Characteristics

Terminations			● (< 115 A)
Connection lugs			● (> 115 A)
Insulation class			B
Rated frequency	Hz		50 - 60
Primary tapping			± 5 %
Degree of Protection			IP00
Separate windings			●
Fully vacuum-impregnated			●
Rated duty factor	% DF		100

Electrical characteristics

Note			The following applies for the no-load loss, short-circuit loss (copper losses), short-circuit voltage and efficiency values: all details relate to a temperature of 20 °C
Total weight	kg		2.9
No-load losses	W		9
Short-circuit losses	W		21
Shortcircuit voltage	%		6.3
Efficiency			0.9

Design verification as per IEC/EN 61439

Technical data for design verification			
Rated operational current for specified heat dissipation	I _n	A	0
Heat dissipation per pole, current-dependent	P _{vid}	W	0
Equipment heat dissipation, current-dependent	P _{vid}	W	0
Static heat dissipation, non-current-dependent	P _{vs}	W	30
Heat dissipation capacity	P _{diss}	W	0
Operating ambient temperature min.		°C	-25
Operating ambient temperature max.		°C	40

IEC/EN 61439 design verification		
10.2 Strength of materials and parts		
10.2.2 Corrosion resistance		Meets the product standard's requirements.
10.2.3.1 Verification of thermal stability of enclosures		Meets the product standard's requirements.
10.2.3.2 Verification of resistance of insulating materials to normal heat		Meets the product standard's requirements.
10.2.3.3 Verification of resistance of insulating materials to abnormal heat and fire due to internal electric effects		Meets the product standard's requirements.
10.2.4 Resistance to ultra-violet (UV) radiation		Meets the product standard's requirements.
10.2.5 Lifting		Does not apply, since the entire switchgear needs to be evaluated.
10.2.6 Mechanical impact		Does not apply, since the entire switchgear needs to be evaluated.
10.2.7 Inscriptions		Meets the product standard's requirements.
10.3 Degree of protection of ASSEMBLIES		Does not apply, since the entire switchgear needs to be evaluated.
10.4 Clearances and creepage distances		Meets the product standard's requirements.
10.5 Protection against electric shock		Does not apply, since the entire switchgear needs to be evaluated.
10.6 Incorporation of switching devices and components		Does not apply, since the entire switchgear needs to be evaluated.
10.7 Internal electrical circuits and connections		Is the panel builder's responsibility.
10.8 Connections for external conductors		Is the panel builder's responsibility.
10.9 Insulation properties		
10.9.2 Power-frequency electric strength		Is the panel builder's responsibility.
10.9.3 Impulse withstand voltage		Is the panel builder's responsibility.
10.9.4 Testing of enclosures made of insulating material		Is the panel builder's responsibility.
10.10 Temperature rise		The panel builder is responsible for the temperature rise calculation. Eaton will provide heat dissipation data for the devices.
10.11 Short-circuit rating		Is the panel builder's responsibility. The specifications for the switchgear must be observed.
10.12 Electromagnetic compatibility		Is the panel builder's responsibility. The specifications for the switchgear must be observed.
10.13 Mechanical function		The device meets the requirements, provided the information in the instruction leaflet (IL) is observed.

Technical data ETIM 7.0

Low-voltage industrial components (EG000017) / One-phase control transformer (EC002486)		
Electric engineering, automation, process control engineering / Transformer, converter, coil / Control transformer / One-phase control transformer (ecl@ss10.0.1-27-03-13-02 [AAB620015])		
Built as safety transformer		No
Built as isolating transformer		No
Built as energy saving transformer		No
Primary voltage 1	V	400 - 400
Primary voltage 2	V	0 - 0
Primary voltage 3	V	0 - 0
Primary voltage 4	V	0 - 0
Primary voltage 5	V	0 - 0
Primary voltage 6	V	0 - 0
Primary voltage 7	V	0 - 0
Primary voltage 8	V	0 - 0
Primary voltage 9	V	0 - 0
Primary voltage 10	V	0 - 0
Secondary voltage 1	V	230 - 230
Secondary voltage 2	V	0 - 0
Secondary voltage 3	V	0 - 0
Secondary voltage 4	V	0 - 0
Secondary voltage 5	V	0 - 0
Secondary voltage 6	V	0 - 0
Secondary voltage 7	V	0 - 0
Secondary voltage 8	V	0 - 0
Secondary voltage 9	V	0 - 0
Secondary voltage 10	V	0 - 0
Rated apparent power	VA	200

Type of insulation material acc. IEC 85		B
Short-circuit-proof		No
Relative short circuit voltage	%	6.3
Width	mm	106
Height	mm	124
Depth	mm	83
Degree of protection (IP)		IP00
Ring core		No
Suitable for mounting on PCB		No
Modular version		No
Conductor material		Copper

Approvals

Product Standards		UL 506; UL5085-1; UL 5085-2; CSA-C22.2 No. 66; CSA-C22.2 No. 66.1-06; CSA-C22.2 No. 66.2-06; IEC/EN 61558-2-2; CE marking
UL File No.		E167225
UL Category Control No.		XPTQ2, XPTQ8
CSA File No.		UL report applies to both US and Canada
CSA Class No.		-
North America Certification		UL recognized, certified by UL for use in Canada
Specially designed for North America		No
Suitable for		Branch circuits
Max. Voltage Rating		600 V AC
Degree of Protection		IEC: IP00, UL/CSA Type: -

Dimensions

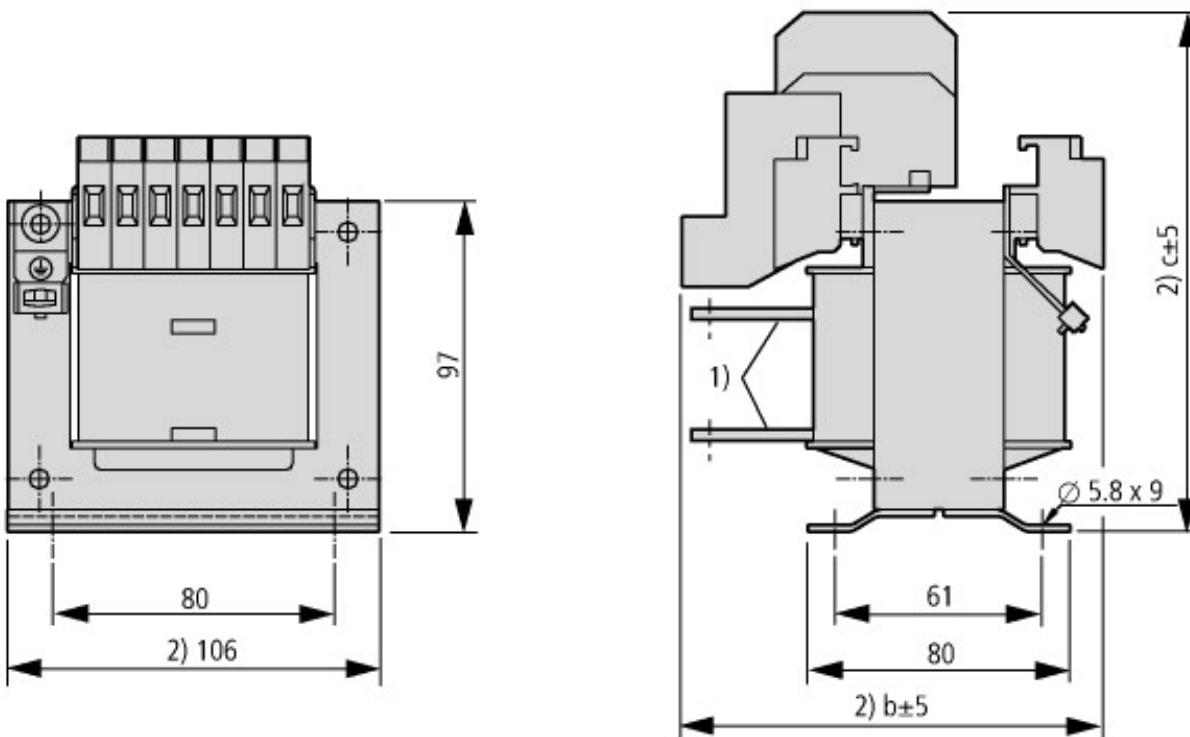

	b	c
12 V	103	121
24 V	83	112
42 V	83	112
110 V	82	112
200/230 V	82	112

- ① Connection lugs
- ② Maximum space requirement
- ③ with STN0,06-02 ground connection at bottom