



Indicator light, Flat, Cable (black) with M8 plug, 4 pole, 0.2 m, Lens yellow, LED white, 24 V AC/DC

Part no. **C22-L-Y-24-P30**
Catalog No. **185128**

Delivery program

Product range			RMQ compact solution
Basic function			Indicator lights
Single unit/Complete unit			Complete unit
Design			Flat
Connection type			Cable (black) with M8 plug, 4 pole
Cable Length		m	0.2
Colour			
Lens			yellow
Lens			
LED			
LED			white
Rated operational voltage LED			24 V AC/DC
Degree of Protection			IP66, IP67, IP69 (front) IP65 (on rear)
Connection to SmartWire-DT			no
Contact sequence			

Technical data

General			
Standards			IEC/EN 60947-5-1 VDE 0660
Certifications			CE, UL, CSA
Lifespan, mechanical	Operations	x 10 ⁶	> 1
Plug tightening torque		N/m	0.6
Tightening torque Threaded ring		Nm	2
Climatic proofing			Damp heat, constant, to IEC 60068-2-78 Damp heat, cyclic, to IEC 60068-2-30

Degree of Protection			IP66, IP67, IP69 (front) IP65 (on rear)
Ambient temperature			
Open		°C	-30 - +70
Storage		°C	- 30 - + 80
Mounting position			As required
Mechanical shock resistance, shock duration 11 ms		g	> 30

Contacts

Rated impulse withstand voltage	U_{imp}	V AC	800
Rated insulation voltage	U_i	V	30
Overvoltage category/pollution degree			III/3
Max. short-circuit protective device			
Fuse	gG/gL	A	4
Rated conditional short-circuit current	I_q	kA	1

Cable characteristics

Design			M8
Cable Length		m	0.2
Material characteristic			PUR
Diameter	∅	mm	4.7

Design verification as per IEC/EN 61439

Technical data for design verification			
Operating ambient temperature min.		°C	-30
Operating ambient temperature max.		°C	70

Technical data ETIM 7.0

Low-voltage industrial components (EG000017) / Indicator light complete (EC000272)			
Electric engineering, automation, process control engineering / Low-voltage switch technology / Command and alarm device / Indicator light complete (ecl@ss10.0.1-27-37-12-23 [AKF041014])			
Number of indicator lights			1
Colour lens			Yellow
Type of lamp socket			LED
With light source			Yes
Rated operating voltage U_e		V	24 - 24
Voltage type			AC/DC
Type of electric connection			Other
Construction type lens			Round
Type of lens			Flat
Hole diameter		mm	22.5
Width opening		mm	0
Height opening		mm	0
With front ring			Yes
Material front ring			Plastic
Colour front ring			Other
Degree of protection (IP)			Other
Degree of protection (NEMA)			Other

Approvals

Product Standards			IEC/EN 60947-5-1; UL 508; CAN/CSA-C22.2 No. 14-18 and No. 94.2-15; CE marking
UL File No.			E29184
UL Category Control No.			NKCR
CSA File No.			165628
CSA Class No.			321103
North America Certification			UL listed, CSA certified

Dimensions

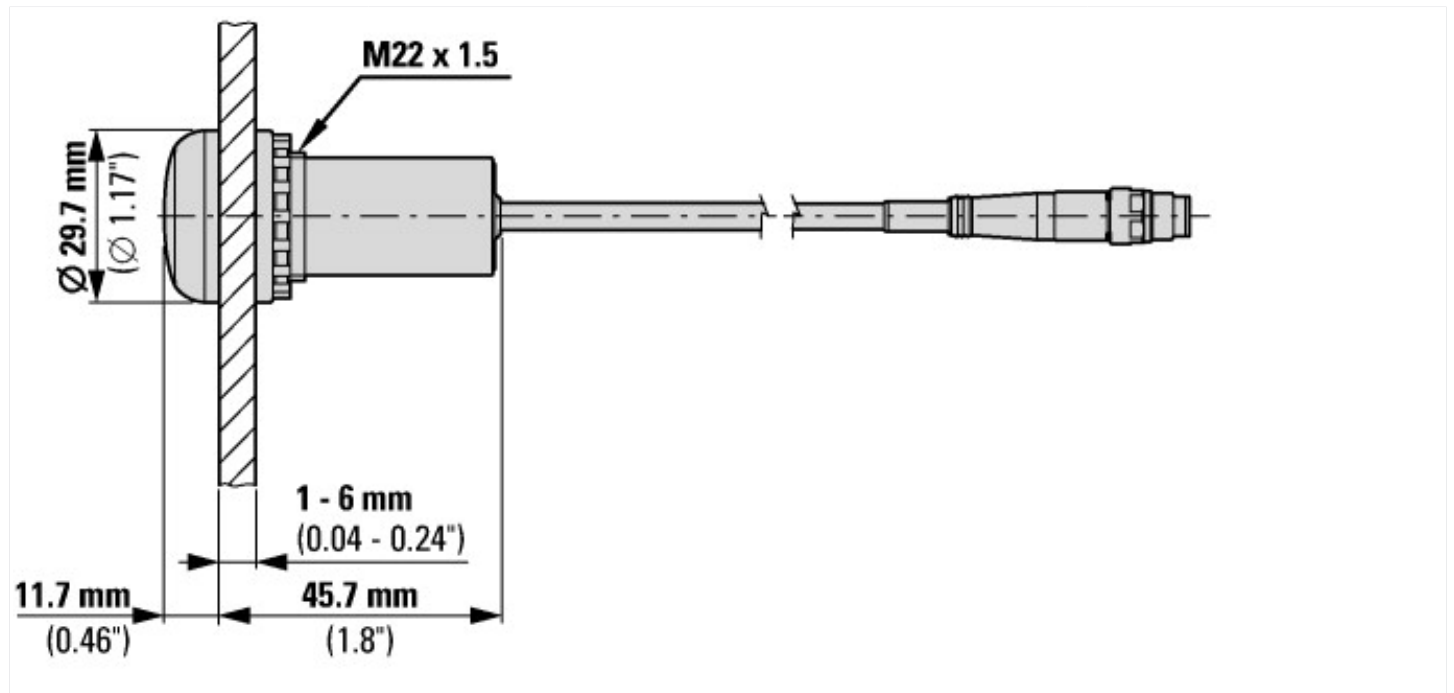

Assets (links)

Declaration of CE Conformity

00003256

Instruction Leaflets

IL047016ZU2018_06

Additional product information (links)

IL047016ZU RMQ compact solution

IL047016ZU RMQ compact solution

ftp://ftp.moeller.net/DOCUMENTATION/AWA_INSTRUCTIONS/IL047016ZU2018_06.pdf