



Touch panel, 24 V DC, 5.7z, TFTcolor, ethernet, RS232, RS485, CAN, PLC, rear mounting

Part no. **XV-112-D6-57TVRC-00**
 Catalog No. **153469**
 Alternate Catalog No. **XV-112-D6-57TVRC-00**
 EL-Nummer (Norway) **4560845**

Delivery program

Product range			XV100 5.7"
Product range			XV-112
Function			HMI-PLC (integrated SPS function)
Common features of the model series			Ethernet interface USB device USB Host Slot for SD card UL508, cUL approvals
Display - Type			Color display, TFT
Touch-technology			Resistive-Touch
Number of colours			64 k Colours
Resolution		Pixel	VGA 640 x 480
Portrait format			yes
Screen diagonal		Inch	5.7
Model			Metal enclosure
Operating system			Windows CE 5.0 (licence incl.)
PLC-licence			PLC licence inclusive
License certificates for onboard interfaces			Not required
built-in interfaces			1 x Ethernet 10/100 Mbps 1 x RS232 1 x RS485 1 x USB host 2.0 1 x USB device 1 x CANopen®/easyNet
Front type			without front plate
Utilization			Rear mounting
Slots			for SD card: 1
Memory card automation			Optionally with SD card -> article no. 139807
Pluggable communication cards (optional)			no
Touch sensor			Glass with film
Heat dissipation		W	9.5

Technical data

Display

Display - Type			Color display, TFT
Screen diagonal		Inch	5.7
Resolution		Pixel	VGA 640 x 480
Number of colours			64 k Colours
Contrast ratio (Normally)			Normally 300:1
Brightness		cd/m ²	Normally 250
Back-lighting			LED dimmable via software
Service life of back-lighting		h	Normally 40000
Resistive touch protective screen			Touch sensor (glass with foil)

Operation

Technology			Resistive-Touch 4 wire
Touch sensor			Glass with film

System

Processor			RISC CPU, 32 Bit, 400 MHz
Internal memory			DRAM (OS, Program and data memory): 64 MByte NAND-Flash (can be used for data backup): approx. 128 MByte available NVRAM (retained data): approx. 32 KByte available
External memory			SD Memory Card Slot: SDA Specification 1.00
Cooling			Fanless CPU and system cooling, natural convection-based passive cooling
Back-up of real-time clock			
Battery (service life)			non-replaceable, CR2032 soldered in
Backup (time at zero voltage)			Normally 10 years

Engineering

Visualisation software			GALILEO EPAM XSOF-TCODESYS-2 XSOF-TCODESYS-3
PLC-Programming software			XSOF-TCODESYS-2 XSOF-TCODESYS-3
PLC-licence			PLC licence inclusive
Operating system			Windows CE 5.0 (licence incl.)

Interfaces, communication

built-in interfaces			1 x Ethernet 10/100 Mbps 1 x RS232 1 x RS485 1 x USB host 2.0 1 x USB device 1 x CANopen®/easyNet
USB Host			USB 2.0 (1.5 - 12 Mbit/s), not galvanically isolated
USB device			USB 2.0, not galvanically isolated
Slots			for SD card: 1
Ethernet			100Base-TX/10Base-T

Power supply

Nominal voltage			24 V DC SELV (safety extra low voltage)
permissible voltage			Effective: 19.2-30.0 V DC (rated operating voltage -20%/+25%) Absolute with ripple: 18.0-31.2 V DC Battery powered: 18.0-31.2 V DC (rated operating voltage -25%/+30%) 35 V DC for a duration of < 100 ms
Voltage dips		ms	≤ 10 ms from rated voltage (24 V DC) 5 ms from undervoltage (19.2 V DC)
Power consumption	P _{max.}	W	10
Note on power consumption			Basic device USB Slave to USB Host: 2.5 Total: 9.5
Heat dissipation		W	9.5
Note on heat dissipation			Heat dissipation with power consumption for 24 V 7 W for basic device + 2.5 W for USB module
Siemens MPI, (optional)			yes
Type of fuse			Yes (fuse not accessible)
Potential isolation			no potential isolation

General

Housing material			Metal, anodized
Front type			without front plate
Dimensions (W x H x D)		mm	172 x 115 x 39
flush mounted			Clearance: W x H x D ≥ 30 mm (1.18") Inclination from vertical: ±45° (if using natural convection)
Degree of protection (IEC/EN 60529, EN50178, VBG 4)			IP65 (at front), IP20 (at rear)
Approvals			
Approvals			cUL (UL508) EAC
Explosion protection (according to ATEX 94/9/EC)			II 3D Ex II T70°C IP5x: Zone 22, Category 3D
Applied standards and directives			
EMC			(in relation to CE) EN 61000-6-2 EN 61000-6-4 EN 61131-2
Product standards			EN 50178 EN 61131-2

Security			EN 60950 UL 60950
Mechanical shock resistance		g	according to IEC 60068-2-27
Vibration			according to IEC/EN 60068-2-6
RoHS			conform

Environmental conditions

Climatic environmental conditions			
Air pressure (operation)		hPa	795 - 1080
Temperature			
Storage / Transport	θ	°C	-20 - +60
Operating ambient temperature min.		°C	0
Operating ambient temperature max.		°C	+ 50
Relative humidity			
Relative humidity			10 - 95%, non-condensing

Supply voltage U_{Aux}

Rated operational voltage	U_{Aux}	V	24 V DC (-20/+25%)
Protection against polarity reversal			Yes
Potential isolation			No

Supply voltage U_{Pow}

Supply voltage	U_{Pow}	V	24 DC -20 % + 25 %
Siemens MPI, (optional)			yes

Design verification as per IEC/EN 61439

Technical data for design verification			
Rated operational current for specified heat dissipation	I_n	A	0
Heat dissipation per pole, current-dependent	P_{vid}	W	0
Equipment heat dissipation, current-dependent	P_{vid}	W	0
Static heat dissipation, non-current-dependent	P_{vs}	W	9.5
Heat dissipation capacity	P_{diss}	W	0
Operating ambient temperature min.		°C	0
Operating ambient temperature max.		°C	50
IEC/EN 61439 design verification			
10.2 Strength of materials and parts			
10.2.2 Corrosion resistance			
10.2.3.1 Verification of thermal stability of enclosures			Meets the product standard's requirements.
10.2.3.2 Verification of resistance of insulating materials to normal heat			Meets the product standard's requirements.
10.2.3.3 Verification of resistance of insulating materials to abnormal heat and fire due to internal electric effects			Meets the product standard's requirements.
10.2.4 Resistance to ultra-violet (UV) radiation			Please enquire
10.2.5 Lifting			Does not apply, since the entire switchgear needs to be evaluated.
10.2.6 Mechanical impact			Does not apply, since the entire switchgear needs to be evaluated.
10.2.7 Inscriptions			Meets the product standard's requirements.
10.3 Degree of protection of ASSEMBLIES			Meets the product standard's requirements.
10.4 Clearances and creepage distances			Meets the product standard's requirements.
10.5 Protection against electric shock			Does not apply, since the entire switchgear needs to be evaluated.
10.6 Incorporation of switching devices and components			Does not apply, since the entire switchgear needs to be evaluated.
10.7 Internal electrical circuits and connections			Is the panel builder's responsibility.
10.8 Connections for external conductors			Is the panel builder's responsibility.
10.9 Insulation properties			
10.9.2 Power-frequency electric strength			Is the panel builder's responsibility.
10.9.3 Impulse withstand voltage			Is the panel builder's responsibility.
10.9.4 Testing of enclosures made of insulating material			Is the panel builder's responsibility.
10.10 Temperature rise			The panel builder is responsible for the temperature rise calculation. Eaton will provide heat dissipation data for the devices.
10.11 Short-circuit rating			Is the panel builder's responsibility.
10.12 Electromagnetic compatibility			Is the panel builder's responsibility.

Technical data ETIM 7.0

PLC's (EG000024) / Graphic panel (EC001412)		
Electric engineering, automation, process control engineering / Display and control component / Panel (HMI) / Graphic panel (HMI) (ec1@ss10.0.1-27-33-02-01 [AFX016003])		
Supply voltage AC 50 Hz	V	0 - 0
Supply voltage AC 60 Hz	V	0 - 0
Supply voltage DC	V	20.4 - 28.8
Voltage type of supply voltage		DC
Number of HW-interfaces industrial Ethernet		1
Number of interfaces PROFINET		0
Number of HW-interfaces RS-232		1
Number of HW-interfaces RS-422		0
Number of HW-interfaces RS-485		1
Number of HW-interfaces serial TTY		0
Number of HW-interfaces USB		2
Number of HW-interfaces parallel		0
Number of HW-interfaces Wireless		0
Number of HW-interfaces other		1
With SW interfaces		Yes
Supporting protocol for TCP/IP		Yes
Supporting protocol for PROFIBUS		No
Supporting protocol for CAN		Yes
Supporting protocol for INTERBUS		No
Supporting protocol for ASI		No
Supporting protocol for KNX		No
Supporting protocol for MODBUS		Yes
Supporting protocol for Data-Highway		No
Supporting protocol for DeviceNet		No
Supporting protocol for SUCONET		No
Supporting protocol for LON		No
Supporting protocol for PROFINET IO		No
Supporting protocol for PROFINET CBA		No
Supporting protocol for SERCOS		No
Supporting protocol for Foundation Fieldbus		No
Supporting protocol for EtherNet/IP		Yes
Supporting protocol for AS-Interface Safety at Work		No
Supporting protocol for DeviceNet Safety		No
Supporting protocol for INTERBUS-Safety		No
Supporting protocol for PROFIsafe		No
Supporting protocol for SafetyBUS p		No
Supporting protocol for other bus systems		Yes
Radio standard Bluetooth		No
Radio standard WLAN 802.11		No
Radio standard GPRS		No
Radio standard GSM		No
Radio standard UMTS		No
IO link master		No
Type of display		TFT
With colour display		Yes
Number of colours of the display		65536
Number of grey-scales/blue-scales of display		0
Screen diagonal	inch	5.7
Number of pixels, horizontal		640
Number of pixels, vertical		480

Useful project memory/user memory	kByte	64000
With numeric keyboard		Yes
With alpha numeric keyboard		Yes
Number of function buttons, programmable		0
Number of buttons with LED		0
Number of system buttons		1
Touch technology		Resistive touch
With message indication		Yes
With message system (incl. buffer and confirmation)		Yes
Process value representation (output) possible		Yes
Process default value (input) possible		Yes
With recipes		Yes
Number of password levels		200
With printer output		Yes
Number of online languages		100
Additional software components, loadable		Yes
Degree of protection (IP), front side		IP65
Degree of protection (NEMA), front side		4X
Operation temperature	°C	0 - 50
Rail mounting possible		No
Wall mounting/direct mounting		No
Suitable for safety functions		No
Width of the front	mm	170
Height of the front	mm	130
Built-in depth	mm	34

Approvals

Product Standards		UL508, cULus; IEC/EN 61131-2, CE
UL File No.		E205091
UL Category Control No.		NRAQ
CSA File No.		UL report applies to US and Canada
CSA Class No.		-
North America Certification		UL listed, certified by UL for use in Canada
Current Limiting Circuit-Breaker		No
Degree of Protection		IEC:IP20, UL/CSA Tape: open type

Dimensions

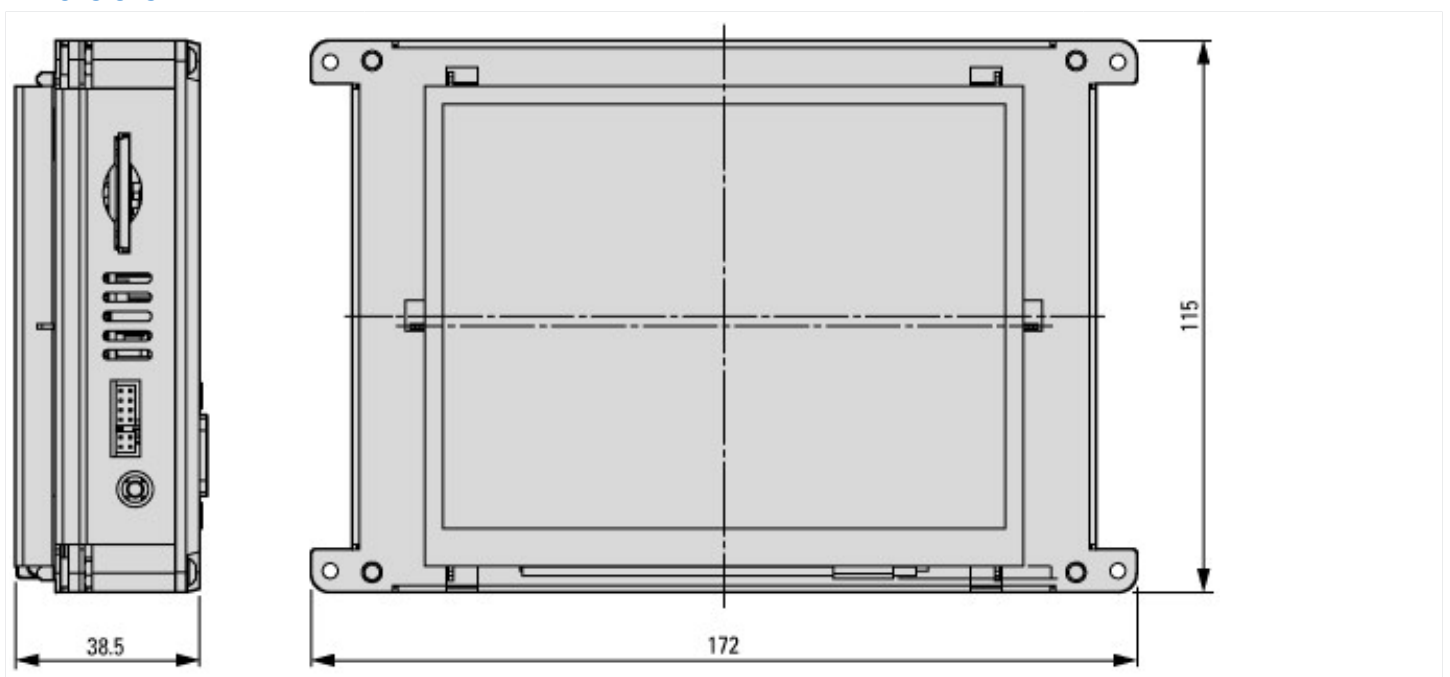

Assets (links)

Declaration of CE Conformity

00002510

Instruction Leaflets

IL04802005Z2018_02

Manuals

MN04802005Z_EN (English)

MN04802013Z_EN (English)

Additional product information (links)

IL04802005Z Instruction Leaflet	
IL04802005Z Instruction Leaflet	ftp://ftp.moeller.net/DOCUMENTATION/AWA_INSTRUCTIONS/IL04802005Z2018_02.pdf
MN04802005Z Operator manual XV-112	
MN04802005Z Bedienerhandbuch XV-112 - Deutsch	ftp://ftp.moeller.net/DOCUMENTATION/AWB_MANUALS/MN04802005Z_DE.pdf
MN04802005Z Operator manual XV-112 - English	ftp://ftp.moeller.net/DOCUMENTATION/AWB_MANUALS/MN04802005Z_EN.pdf
Quick-start manual XV100 MN04802013Z	
Schnellstart-Handbuch XV100 MN04802013Z - Deutsch	ftp://ftp.moeller.net/DOCUMENTATION/AWB_MANUALS/MN04802013Z_DE.pdf
Quick-start manual XV100 MN04802013Z - English	ftp://ftp.moeller.net/DOCUMENTATION/AWB_MANUALS/MN04802013Z_EN.pdf
User manual XSoft-CoDeSys-2, SPS programming XV100 MN04802091Z	
Benutzerhandbuch XSoft-CoDeSys-2, SPS-Programmierung XV100 MN04802091Z - Deutsch	ftp://ftp.moeller.net/DOCUMENTATION/AWB_MANUALS/MN04802091Z-DE.pdf
User manual XSoft-CoDeSys-2, SPS programming XV100 MN04802091Z - English	ftp://ftp.moeller.net/DOCUMENTATION/AWB_MANUALS/MN04802091Z-EN.pdf
Manual XSOF-CODESYS-3, SPS programming MN048008ZU	
Handbuch XSOF-CODESYS-3, SPS-Programmierung MN048008ZU - Deutsch	ftp://ftp.moeller.net/DOCUMENTATION/AWB_MANUALS/MN048008ZU_DE.pdf
Manual XSOF-CODESYS-3, SPS programming MN048008ZU - English	ftp://ftp.moeller.net/DOCUMENTATION/AWB_MANUALS/MN048008ZU_EN.pdf
f1=1454&f2=1242&f3=1773;Download Software GALILEO	http://applications.eaton.eu/sdlc?LX=11&f1=1454&f2=1242&f3=1773;Download Software GALILEO
Product overview (WEB)	http://www.eaton.eu/xv