



Speed controller, 4.3 A, 1.5 kW, 230/277 V AC, AS-Interface®, S-7.4 for 31 modules, with manual override switch



Part no. RASP-402AI1S0-C32RS1
 Catalog No. 150210
 Alternate Catalog No. RASP-402AI1S0-C32RS1

Delivery program

			This item is only available until 06/30/2020, after which it will be replaced with the following item: Y7-198561, RASP5-4202A31-512R000S1
Product range			Speed controller
Rated operational voltage	U_e		400 V AC, 3-phase 480 V AC, 3-phase
Output voltage with V_e	U_2		0 - U_{LN}
Mains voltage (50/60Hz)	U_{LN}	V	380 (-15%) - 480 (+10%)
At 150% overload	I_e	A	4.3
assigned motor rating P			
Note			at 400 V, 50 Hz
150 % Overload	P	kW	1.5
Note			at 480 V, 60 Hz
150 % Overload	P	HP	2
Note			for normal internally and externally ventilated 4 pole, three-phase asynchronous motors with 1500 rpm^{-1} at 50 Hz or 1800 min^{-1} at 60 Hz
Description			integrated PTC thermistor monitoring and Thermoclick with safe isolation Two sensor inputs through M12 sockets (max. 150 mA) for quick stop and interlocked manual operation optional: 4 sensor inputs with M12-Y adapter for switchover to creep speed Connection of supply voltage via adapter cable on round or flexible busbar junction Diagnostics and reset on device and via AS-Interface with AUTO - OFF/RESET - HAND key switches 3 fixed speeds and 1 potentiometer speed can be switched over from U/f to (vector) speed control with selector switch REV - OFF - FWD optional: Faster stop if external 24 V fails
Control voltage external brake (50/60 Hz)		V	230/277 V AC
Interface/field bus (built-in)			AS-Interface®
AS-Interface profile cable			S-7.4 for 31 modules
Repair switch			with manual override switch
Instructions for actuation of motors with mechanical brake			

Technical data

General			
Standards			IEC/EN 61800-5-1 UL 61800-5-1 Guideline 2011/65/EU (RoHS) CE approval UL approval
Climatic proofing	ρ_w	%	< 95%, non-condensing IEC/EN 50178
Ambient temperature			
Operating ambient temperature min.		°C	0
Operating ambient temperature max.		°C	+ 40
			0 - +55 (with fan RASP-FAN-1)
Storage	θ	°C	-30 - +70
Overvoltage category			
Rated impulse withstand voltage	U_{imp}	kV	2
Radio interference level			
Environment (EMC)			2. Environment, Class C3
maximum motor cable length	l	m	10
Mechanical shock resistance		g	1000 shocks per shaft, semi-sinusoidal 15 g/11 ms IEC/EN 60068-2-27

Vibration			Oscillation frequency: 10 - 150 Hz Amplitude 0.15 mm: 6 Hz Amplitude transition frequency on acceleration: 57 Hz IEC/EN 60068-2-6
Mounting position			Vertical
Altitude		m	0 - 1000 m above sea level above 1000 m with 1 % performance reduction per 100 m max. 2000 m
Degree of Protection			IP65 NEMA12

Main circuit

Supply			
Rated operational voltage	U_e		400 V AC, 3-phase 480 V AC, 3-phase
Mains voltage (50/60Hz)	U_{LN}	V	380 (-15%) - 480 (+10%)
Input current (150% overload)	I_{LN}	A	5.6
System configuration			AC voltage Center-point earthed star network (TN-S network) Phase-earthed AC supply systems are not permitted.
Supply frequency	f_{LN}	Hz	50/60
Frequency range	f_{LN}	Hz	47 - 66 Hz ($\pm 0\%$)
Mains switch-on frequency			Maximum of one time every 60 seconds
Mains current distortion	THD	%	> 120
Rated conditional short-circuit current	I_q	kA	< 5
Short-circuit protection for output circuits, external			Type 1 coordination via the power bus' feeder unit
Power section			
Function			Variable frequency drive with internal DC link and IGBT inverter
On-delay	t_{ON}	ms	30 - 50
Off-delay	t_{OFF}	ms	15 - 35
Overload current (150% overload)	I_L	A	6.5
Note regarding overload current			at 40 °C
Note about max. starting current			for 2 seconds at 40 °C
Output voltage with V_e	U_2		0 - U_{LN}
Output Frequency	f_2	Hz	0 - 50/60 (max. 320)
Switching frequency	f_{PWM}	kHz	6 adjustable 1.5 - 16
Operation Mode			linear, parameterizable
Frequency resolution (setpoint value)	Δf	Hz	0.01
Rated operational current			
At 150% overload	I_e	A	4.3
Note			Rated operational current at an operating frequency of 6 kHz and an ambient air temperature of +40 °C
Motor current limit	I	A	0.86 - 8.6 adjustable
Efficiency	η	%	0.96
Maximum leakage current to ground (PE) without motor	I_{PE}	mA	3.5
Fan			internal, temperature controlled optional RASP-FAN-S1 on heat sink, temperature-controlled
Fitted with			with manual override switch without fan without braking resistance
Motor feeder			
Note			for normal internally and externally ventilated 4 pole, three-phase asynchronous motors with 1500 rpm ⁻¹ at 50 Hz or 1800 min ⁻¹ at 60 Hz
Note			at 400 V, 50 Hz
150 % Overload	P	kW	1.5
Note			at 480 V, 60 Hz
150 % Overload	P	HP	2
Actuator for external motor brake			
Braking voltage	U	V	230/277 V AC -15% / +10%
Braking current	I	A	≤ 0.6 A

Braking function			(max. 6 A for 120 ms)
DC braking	%	I/I _e	≤ 100, adjustable

Control section

External control voltage	U _c	V	24 V DC - 15 % / + 20 % via AS-Interface® plug
Interface/field bus (built-in)			AS-Interface®
AS-Interface®			max. total power consumption from AS-Interface® power supply unit (30 V): 250 mA Specification: S-7.4 Number of slave addresses: 31

Design verification as per IEC/EN 61439

Technical data for design verification			
Operating ambient temperature min.		°C	0
Operating ambient temperature max.		°C	40

Technical data ETIM 7.0

Devices for distribution board-/surface mounting (EG000062) / Speed controller (EC000256)			
Electric engineering, automation, process control engineering / Electrical installation, device / Modular serial built-in device for electrical circuit distributors / Speed controller (ec1@ss10.0.1-27-14-23-20 [ACN359011])			
Mounting method			Surface mounted (plaster)
Colour			Grey
RAL-number			0
Nominal current		A	4.3
Output voltage		V	0 - 400
Number of phases			3
Power control step less			Yes
Number of steps			0
Basic element without cover			Yes
Method of operation			Key
Illumination			None
Switching contact			No
With temperature sensor			Yes
Height		mm	270
Width		mm	220
Depth		mm	195
Degree of protection (IP)			IP65

Dimensions

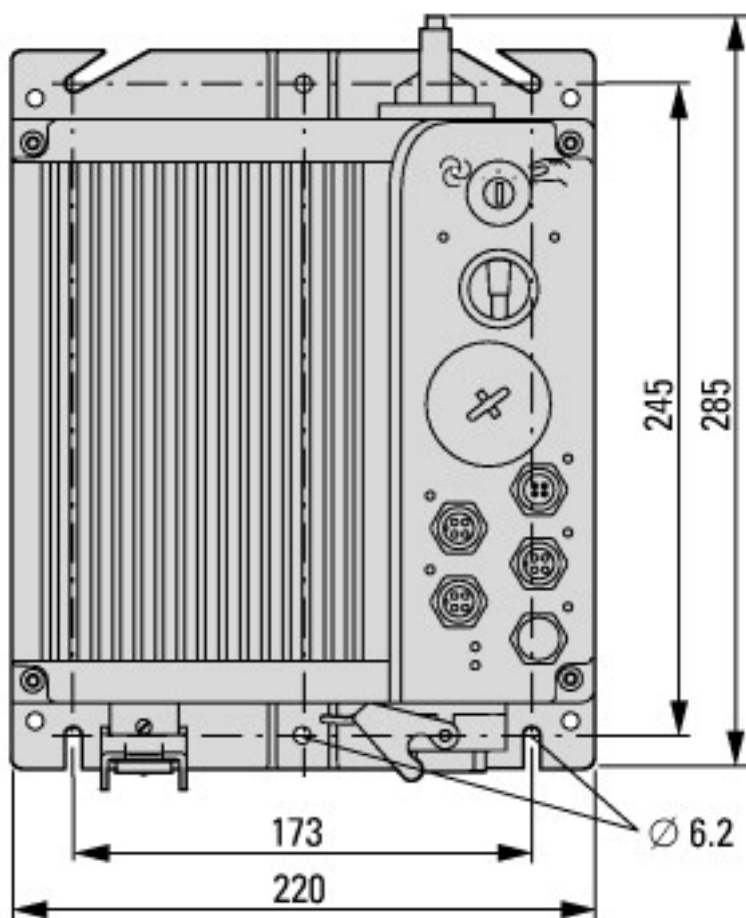
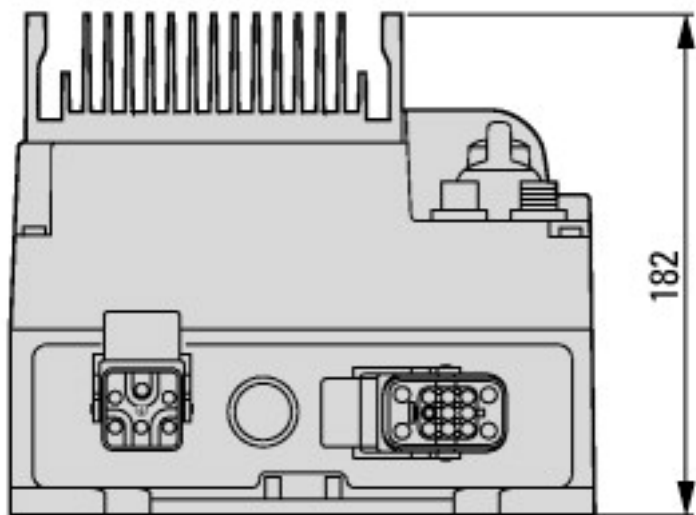

Assets (links)

Declaration of CE Conformity

00002337

Instruction Leaflets

IL03406020Z2018_05

Manuals

MN03406003Z_EN (English)

Additional product information (links)

IL03406020Z Rapid Link: Speed Control Unit

IL03406020Z Rapid Link: Speed Control Unit ftp://ftp.moeller.net/DOCUMENTATION/AWA_INSTRUCTIONS/IL03406020Z2018_05.pdf

MN03406003Z Rapid Link 4.0

MN03406003Z Rapid Link 4.0 - Deutsch ftp://ftp.moeller.net/DOCUMENTATION/AWB_MANUALS/MN03406003Z_DE.pdf

MN03406003Z Rapid Link 4.0 - English	ftp://ftp.moeller.net/DOCUMENTATION/AWB_MANUALS/MN03406003Z_EN.pdf
MN03406003Z Rapid Link 4.0 - français	ftp://ftp.moeller.net/DOCUMENTATION/AWB_MANUALS/MN03406003Z_FR.pdf
CA04020001Z-EN Product Range Catalog: Efficient Engineering for Starting and Controlling Motors	http://www.eaton.eu/DE/ecm/groups/public/@pub/@europe/@electrical/documents/content/pct_1095238.pdf