



Sensor fixing, M12 sensors, inductive

Part no. E57KNZ12
 Catalog No. 136198
 Alternate Catalog No. E57KNZ12

Delivery program

Basic function			Accessories
Accessories			Sensor fixing
For use with			
For use with			M12 sensors, inductive

Design verification as per IEC/EN 61439

Technical data for design verification			
Operating ambient temperature min.		°C	-25
Operating ambient temperature max.		°C	70

Technical data ETIM 7.0

Sensors (EG000026) / Accessories for position switches (EC002594)			
Electric engineering, automation, process control engineering / Binary sensor technology, safety-related sensor technology / Position switch / Position switch (accessories) (ecI@ss10.0.1-27-27-06-92 [AFR520003])			
Type of accessory			Other

Approvals

Product Standards			none
-------------------	--	--	------

Dimensions

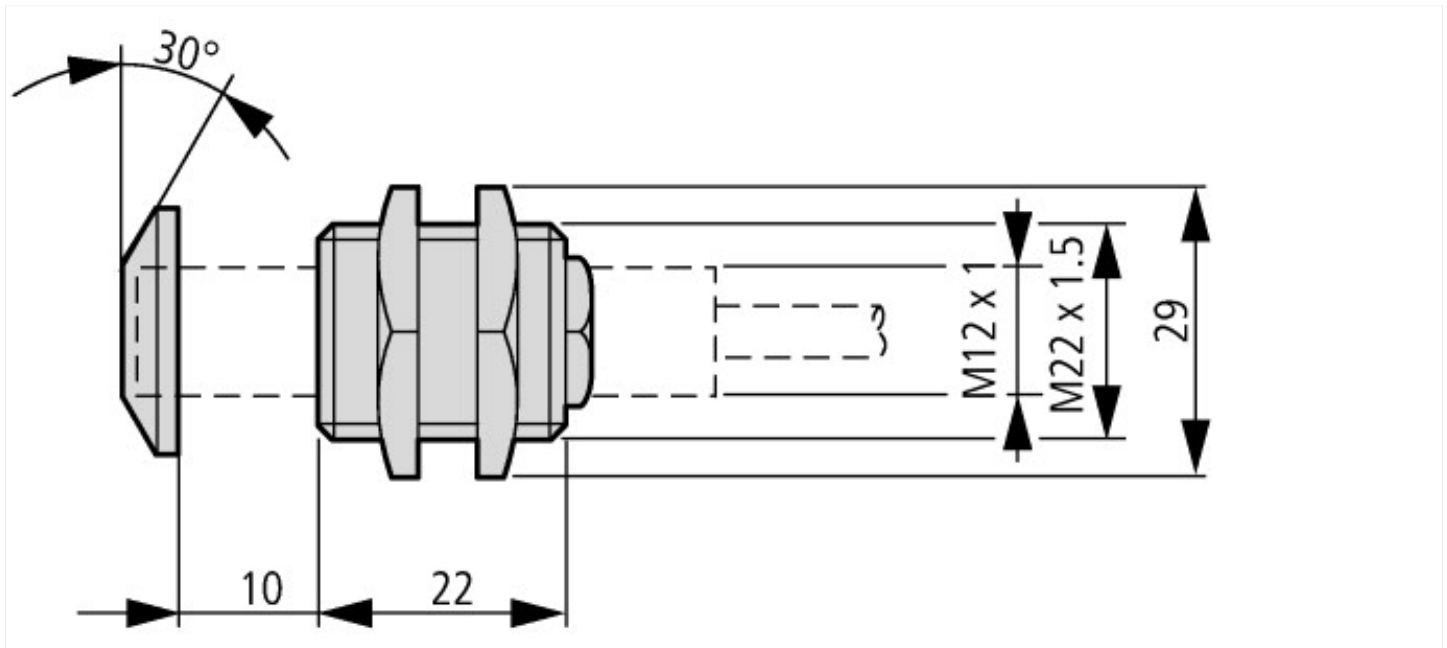

Assets (links)

Declaration of CE Conformity
 00003158