



**Variable frequency drive, 600 V AC, 3-phase, 18.5 kW, IP54, Radio interference suppression filter, OLED display, FR6**

**Part no.** SPX020A2-5A4N1  
**Catalog No.** 125293  
**Alternate Catalog No.** SPX020A2-5A4N1  
**EL-Nummer (Norway)** 4100131

## Delivery program

Product range			Variable frequency drives
Part group reference (e.g. DIL)			SPX
Rated operational voltage	$U_e$		600 V AC, 3-phase 690 V AC, 3-phase
Output voltage with $V_e$	$U_2$		600 V AC, 3-phase 690 V AC, 3-phase
Mains voltage (50/60Hz)	$U_{LN}$	V	525 (-15%) - 690 (±10%)
<b>Rated operational current</b>			
At 150% overload	$I_e$	A	22
At 110% overload	$I_e$	A	27
<b>Assigned motor rating</b>			
Note			For AC motors with internal and external ventilation with 50 Hz / 60 Hz
Note			Overload cycle for 60 s every 600 s
Note			at 690 V, 50 Hz
150 % Overload	P	kW	18.5
110 % Overload	P	kW	22
150 % Overload	$I_M$	A	20.9
110 % Overload	$I_M$	A	23.8
Note			at 690 V, 60 Hz
150 % Overload	P	HP	20
110 % Overload	P	HP	25
150 % Overload	$I_M$	A	19
110 % Overload	$I_M$	A	23
Degree of Protection			IP54
Fieldbus connection (optional)			PROFIBUS-DP PROFINET EtherCAT EtherNet/IP LonWorks CANopen® DeviceNet Modbus-TCP Modbus-RTU BACnet MS/TP
Fitted with			Radio interference suppression filter OLED display
Frame size			FR6
Connection to SmartWire-DT			no

## Technical data

<b>General</b>			
Standards			Specification for general requirements: IEC/EN 61800-2 EMC requirements: IEC/EN 61800-3 Safety requirements: IEC/EN 61800-5-1
Certifications			CE, UL, cUL, RCM
Approvals			DNV

Production quality			RoHS, ISO 9001
Climatic proofing	$\rho_w$	%	< 95% relative humidity, no condensation, no corrosion, no dripping water
Ambient temperature			
Operating ambient temperature min.		°C	-10
Operating ambient temperature max.		°C	+ 50
operation (110 % overload)	$\theta$	°C	-10 - +40
Storage	$\theta$	°C	-40 - +70
Radio interference level			
Radio interference class (EMC)			C2, C3, depending on the motor cable length, the connected load, and ambient conditions. External radio interference suppression filters (optional) may be necessary.
Environment (EMC)			1st and 2nd environments as per EN 61800-3
Mounting position			Vertical
Altitude		m	0 - 1000 m above sea level above 1000 m with 1 % performance reduction per 100 m max. 3000 m
Degree of Protection			IP54
Protection against direct contact			BGV A3 (VBG4, finger- and back-of-hand proof)

### Main circuit

Supply			
Rated operational voltage	$U_e$		600 V AC, 3-phase 690 V AC, 3-phase
Mains voltage (50/60Hz)	$U_{LN}$	V	525 (-15%) - 690 ( $\pm 10\%$ )
System configuration			AC supply systems with earthed center point
Supply frequency	$f_{LN}$	Hz	50/60
Frequency range	$f_{LN}$	Hz	45–66 ( $\pm 0\%$ )
Power section			
Function			Variable frequency drive with internal DC link and IGBT inverter
Output voltage with $V_e$	$U_2$		600 V AC, 3-phase 690 V AC, 3-phase
Output Frequency	$f_2$	Hz	0 - 50/60 (max. 320)
Switching frequency	$f_{PWM}$	kHz	1.5 adjustable 1 - 6
Operation Mode			U/f control sensorless vector control (SLV) optional: Vector control with feedback (CLV)
Frequency resolution (setpoint value)	$\Delta f$	Hz	0.01
Rated operational current			
At 150% overload	$I_e$	A	22
At 110% overload	$I_e$	A	27
Fitted with			Radio interference suppression filter OLED display
Frame size			FR6
Motor feeder			
Note			For AC motors with internal and external ventilation with 50 Hz / 60 Hz
Note			Overload cycle for 60 s every 600 s
Note			at 690 V, 50 Hz
150 % Overload	P	kW	18.5
110 % Overload	P	kW	22
Note			at 690 V, 60 Hz
150 % Overload	P	HP	20
110 % Overload	P	HP	25

### Control section

External control voltage	$U_c$	V	24 V DC (max. 250 mA)
Reference voltage	$U_s$	V	10 V DC (max. 10 mA)
Analog inputs			2, parameterizable, 0 - 10 V DC, 0/4 - 20 mA
Analog outputs			1, parameterizable, 0/4 - 20 mA
Digital inputs			6, parameterizable, max. 30 V DC
Digital outputs			1, parameterizable, 48 V DC/50 mA

Relay outputs			2, parameterizable, N/O, 8 A (24 V DC) / 8 A (250 V AC) / 0,4 A (125 V DC)
<b>Assigned switching and protective elements</b>			
Power Wiring			
Main choke			
150 % overload (CT/I <sub>H</sub> , at 50 °C)			DX-LN3-040
Motor feeder			
motor choke			
150 % overload (CT/I <sub>H</sub> , at 50 °C)			DX-LM3-035
110 % overload (VT/I <sub>L</sub> , at 40 °C)			DX-LM3-035
Sine filter			
150 % overload (CT/I <sub>H</sub> , at 50 °C)			SIN-0035-6-0-P
110 % overload (VT/I <sub>L</sub> , at 40 °C)			SIN-0035-6-0-P

## Design verification as per IEC/EN 61439

Technical data for design verification			
Rated operational current for specified heat dissipation	I <sub>n</sub>	A	22
Heat dissipation per pole, current-dependent	P <sub>vid</sub>	W	0
Equipment heat dissipation, current-dependent	P <sub>vid</sub>	W	463
Static heat dissipation, non-current-dependent	P <sub>vs</sub>	W	0
Heat dissipation capacity	P <sub>diss</sub>	W	0
Operating ambient temperature min.		°C	-10
Operating ambient temperature max.		°C	50
			Operation (with 150 % overload)
IEC/EN 61439 design verification			
10.2 Strength of materials and parts			
10.2.2 Corrosion resistance			Meets the product standard's requirements.
10.2.3.1 Verification of thermal stability of enclosures			Meets the product standard's requirements.
10.2.3.2 Verification of resistance of insulating materials to normal heat			Meets the product standard's requirements.
10.2.3.3 Verification of resistance of insulating materials to abnormal heat and fire due to internal electric effects			Meets the product standard's requirements.
10.2.4 Resistance to ultra-violet (UV) radiation			Meets the product standard's requirements.
10.2.5 Lifting			Does not apply, since the entire switchgear needs to be evaluated.
10.2.6 Mechanical impact			Does not apply, since the entire switchgear needs to be evaluated.
10.2.7 Inscriptions			Meets the product standard's requirements.
10.3 Degree of protection of ASSEMBLIES			Does not apply, since the entire switchgear needs to be evaluated.
10.4 Clearances and creepage distances			Meets the product standard's requirements.
10.5 Protection against electric shock			Does not apply, since the entire switchgear needs to be evaluated.
10.6 Incorporation of switching devices and components			Does not apply, since the entire switchgear needs to be evaluated.
10.7 Internal electrical circuits and connections			Is the panel builder's responsibility.
10.8 Connections for external conductors			Is the panel builder's responsibility.
10.9 Insulation properties			
10.9.2 Power-frequency electric strength			Is the panel builder's responsibility.
10.9.3 Impulse withstand voltage			Is the panel builder's responsibility.
10.9.4 Testing of enclosures made of insulating material			Is the panel builder's responsibility.
10.10 Temperature rise			The panel builder is responsible for the temperature rise calculation. Eaton will provide heat dissipation data for the devices.
10.11 Short-circuit rating			Is the panel builder's responsibility. The specifications for the switchgear must be observed.
10.12 Electromagnetic compatibility			Is the panel builder's responsibility. The specifications for the switchgear must be observed.
10.13 Mechanical function			The device meets the requirements, provided the information in the instruction leaflet (IL) is observed.

## Approvals

Product Standards			UL 508C; CSA-C22.2 No. 14; IEC/EN61800-3; IEC/EN61800-5; CE marking
UL File No.			E134360
UL Category Control No.			NMMS, NMMS2, NMMS7, NMMS8

CSA File No.		UL report applies to both US and Canada
CSA Class No.		3211-06
North America Certification		UL listed, certified by UL for use in Canada
Specially designed for North America		No
Suitable for		Branch circuits
Max. Voltage Rating		3- 690 V AC IEC: TN-S UL/CSA: "Y" (Solidly Grounded Wey)
Degree of Protection		IEC: IP54

## Dimensions

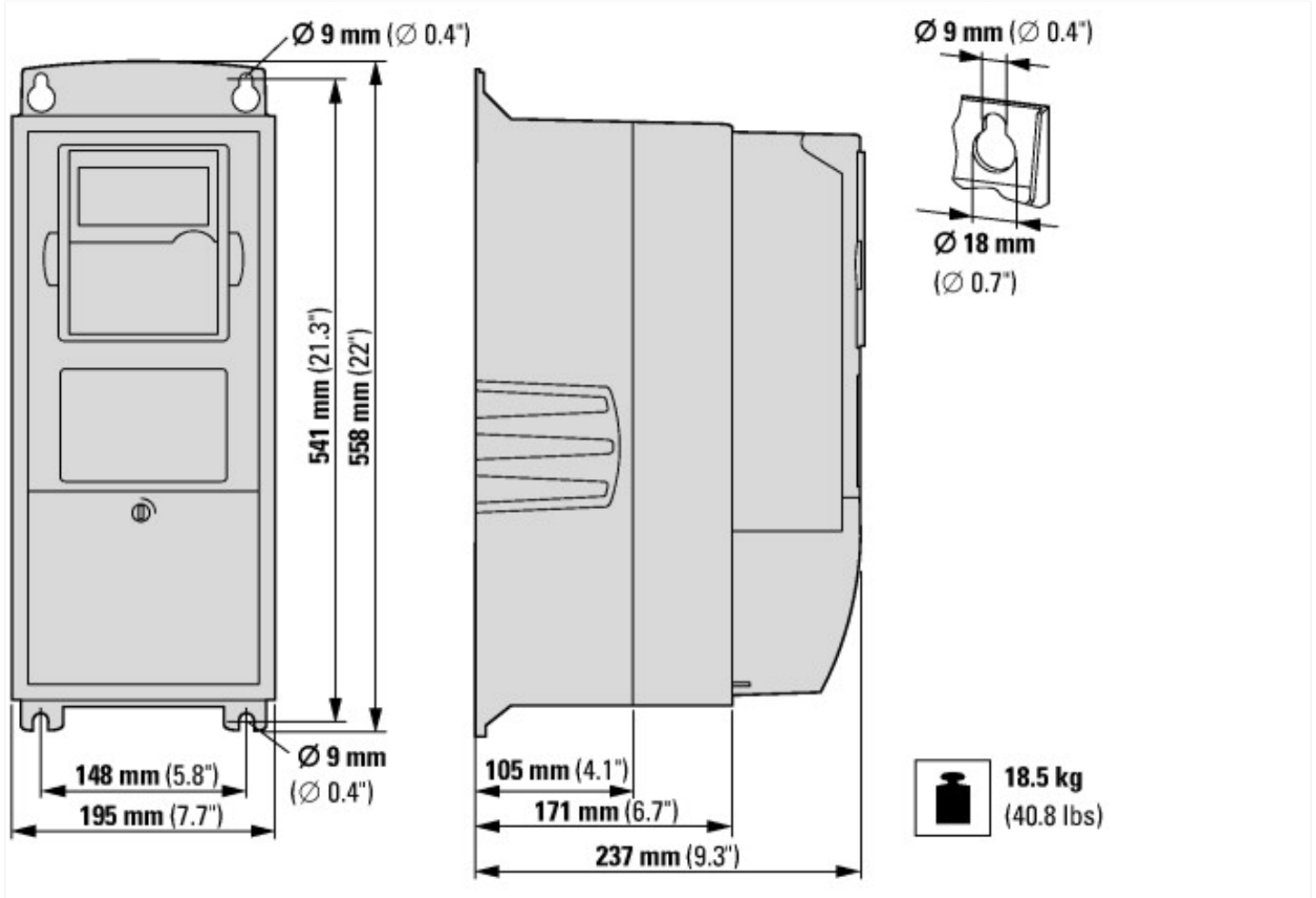

## Assets (links)

### Declaration of CE Conformity

00002807

### Instruction Leaflets

IL04020008Z2018\_05

## Additional product information (links)

### IL04020008Z Frequency inverter 9000X

IL04020008Z Frequency inverter 9000X

[ftp://ftp.moeller.net/DOCUMENTATION/AWA\\_INSTRUCTIONS/IL04020008Z2018\\_05.pdf](ftp://ftp.moeller.net/DOCUMENTATION/AWA_INSTRUCTIONS/IL04020008Z2018_05.pdf)

Documentation

<http://www.eaton.eu/Europe/Electrical/ProductsServices/AutomationControl/SwitchingProtectingDrivingMotors/9000X/SPX9000/index.htm#tabs-4>