



Indicator light, Extended, Screw connection, Lens Red, LED Red, 120 V AC



Powering Business Worldwide™

**Part no.** C22-LH-R-120  
**Catalog No.** 121659  
**Alternate Catalog No.** C22-LH-R-120

### Delivery program

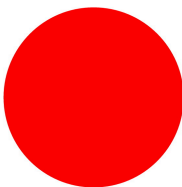
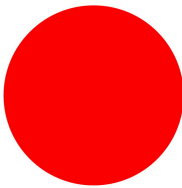
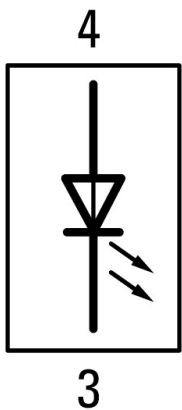
Product range			RMQ Compact
Basic function			Indicator lights
Single unit/Complete unit			Complete unit
Design			Extended
Connection type			Screw connection
<b>Colour</b>			
Lens			Red
Lens			
LED			
LED			Red
Rated operational voltage LED			120 V AC
Degree of Protection			IP66, IP67, IP69
Connection to SmartWire-DT			no
Contact sequence			

### Technical data

<b>General</b>			
Standards			IEC/EN 60947-5-1 VDE 0660
Climatic proofing			Damp heat, constant, to IEC 60068-2-78 Damp heat, cyclic, to IEC 60068-2-30
Degree of Protection			IP66, IP67, IP69
Ambient temperature			
Open		°C	-25 - +70
Storage		°C	- -30 - + 80
Mounting position			As required

Terminal capacities		mm <sup>2</sup>	
Solid		mm <sup>2</sup>	2 x 0.5 - 1.5_x
Flexible with ferrule		mm <sup>2</sup>	2 x 0.5 - 1.5_x
Tightening torque for terminal screw		Nm	0.8

## Contacts

Rated impulse withstand voltage	U <sub>imp</sub>	V AC	4000
Rated insulation voltage	U <sub>i</sub>	V	250
Rated conditional short-circuit current	I <sub>q</sub>	kA	1
Overvoltage category/pollution degree			III/3

## Design verification as per IEC/EN 61439

Technical data for design verification			
Operating ambient temperature min.		°C	-25
Operating ambient temperature max.		°C	70

## Technical data ETIM 7.0

Low-voltage industrial components (EG000017) / Indicator light complete (EC000272)			
Electric engineering, automation, process control engineering / Low-voltage switch technology / Command and alarm device / Indicator light complete (ecl@ss10.0.1-27-37-12-23 [AKF041014])			
Number of indicator lights			1
Colour lens			Red
Type of lamp socket			LED
With light source			Yes
Rated operating voltage U <sub>e</sub>		V	120 - 120
Voltage type			AC
Type of electric connection			Screw connection
Construction type lens			Round
Type of lens			High
Hole diameter		mm	22.5
Width opening		mm	0
Height opening		mm	0
With front ring			Yes
Material front ring			Plastic
Colour front ring			Other
Degree of protection (IP)			Other
Degree of protection (NEMA)			

## Approvals

Product Standards			IEC/EN 60947-5-1; UL 508; CAN/CSA-C22.2 No. 14-05 und 94-M91; CE marking
UL File No.			E29184
UL Category Control No.			NKCR
CSA File No.			165628
CSA Class No.			321103
North America Certification			UL listed, CSA certified
Degree of Protection			1,3R,4X,12,13

## Dimensions

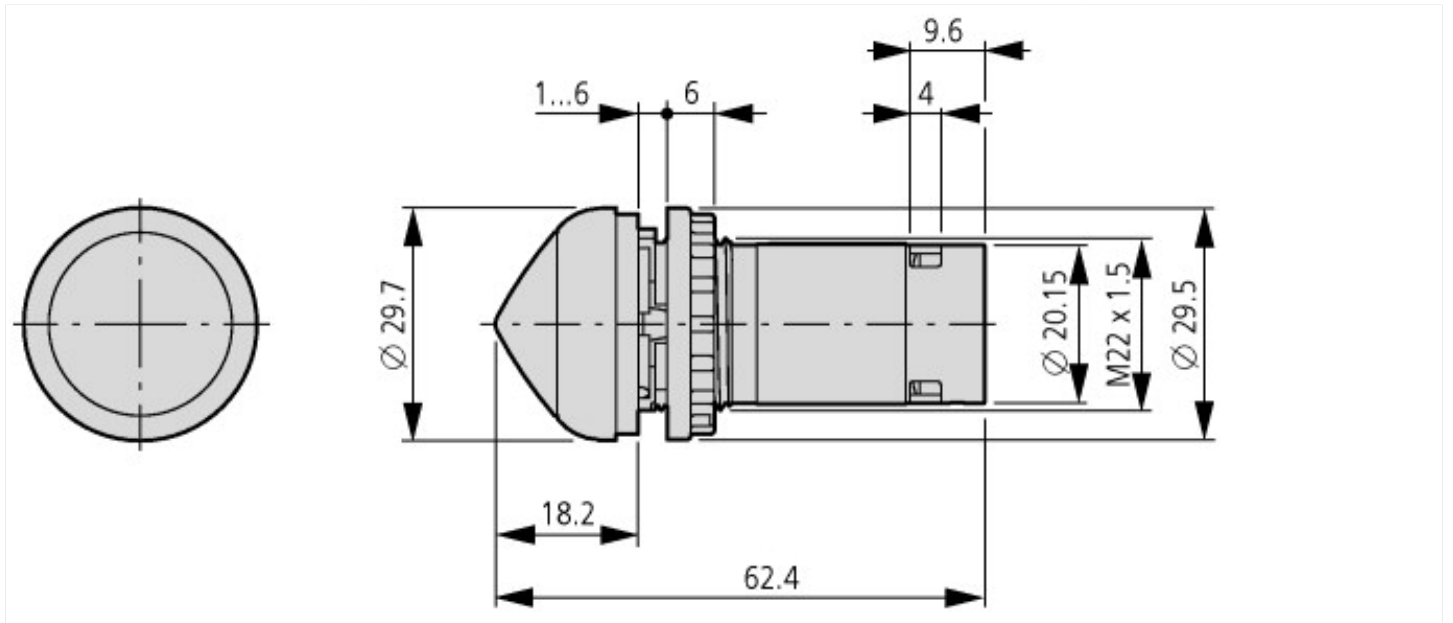

## Additional product information (links)

IL04716025Z RMQ-Titan: compact programm

IL04716025Z RMQ-Titan: compact programm [https://es-assets.eaton.com/DOCUMENTATION/AWA\\_INSTRUCTIONS/IL04716025Z2021\\_05.pdf](https://es-assets.eaton.com/DOCUMENTATION/AWA_INSTRUCTIONS/IL04716025Z2021_05.pdf)