



**Self-monitoring contact elements, Screw terminals, Front fixing, 1 N/O, 2 NC, 24 V 3 A**

**Part no.** M22-K02SMC10  
**Catalog No.** 121474  
**Alternate Catalog No.** M22-K02SMC10Q  
**EL-Nummer (Norway)** 4315253

**Delivery program**

Basic function accessories		Self-monitoring contact elements
Description		The N/O is actuated when mounted on the pushbutton.
Connection technique		Screw terminals
Fixing		Front fixing
Degree of Protection		IP20
Connection to SmartWire-DT		no
Approval		
<b>Contacts</b>		
N/O = Normally open		1 N/O
N/C = Normally closed		2 NC 
Notes		 = safety function, by positive opening to IEC/EN 60947-5-1
<b>Actuator travel and actuation force as per DIN EN 60947-5-1, K.5.4.1</b>		
	mm	4.8
Maximum travel	mm	5.7
Minimum force for positive opening	N	30
Contact sequence		
<b>Contact travel diagram, stroke in connection with front element</b>		
Contact diagram		
Configuration		
Connection technique		Screw terminals

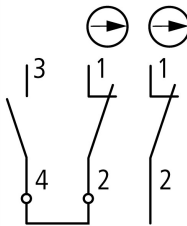
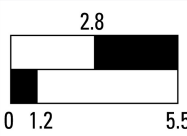
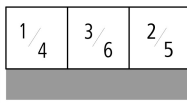
**Technical data**

<b>General</b>		
Standards		IEC 60947-5-1

Actuating force	n	≤ 10
Operating torque (screw terminals)	Nm	≤ 0.8
Degree of Protection		IP20
Climatic proofing		Damp heat, constant, to IEC 60068-2-78 Damp heat, cyclic, to IEC 60068-2-30
Ambient temperature		
Open	°C	-25 - +70
Terminal capacities	mm <sup>2</sup>	
Solid	mm <sup>2</sup>	0.75 - 2.5
Stranded	mm <sup>2</sup>	0.5 - 2.5
Flexible with ferrule	mm <sup>2</sup>	0.5 - 1.5

### Contacts

Rated impulse withstand voltage	U <sub>imp</sub>	V AC	6000
Rated insulation voltage	U <sub>i</sub>	V	500
Overvoltage category/pollution degree			III/3
Max. short-circuit protective device			
Fuseless		Type	PKZM0-10/FAZ-B6/1
Fuse	gG/gL	A	10

### Switching capacity

Rated operational current	I <sub>e</sub>	A	
AC-15			
115 V	I <sub>e</sub>	A	6
220 V 230 V 240 V	I <sub>e</sub>	A	6
380 V 400 V 415 V	I <sub>e</sub>	A	4
500 V	I <sub>e</sub>	A	2
DC-13			
24 V	I <sub>e</sub>	A	3
42 V	I <sub>e</sub>	A	1.7
60 V	I <sub>e</sub>	A	1.2
110 V	I <sub>e</sub>	A	0.6
220 V	I <sub>e</sub>	A	0.3

### Auxiliary contacts

Rated conditional short-circuit current	I <sub>q</sub>	kA	1
---	----------------	----	---

## Design verification as per IEC/EN 61439

Technical data for design verification			
Rated operational current for specified heat dissipation	I <sub>n</sub>	A	6
Heat dissipation per pole, current-dependent	P <sub>vid</sub>	W	0.11
Equipment heat dissipation, current-dependent	P <sub>vid</sub>	W	0
Static heat dissipation, non-current-dependent	P <sub>vs</sub>	W	0
Heat dissipation capacity	P <sub>diss</sub>	W	0
Operating ambient temperature min.		°C	-25
Operating ambient temperature max.		°C	70
IEC/EN 61439 design verification			
10.2 Strength of materials and parts			
10.2.2 Corrosion resistance			
			Meets the product standard's requirements.
10.2.3.1 Verification of thermal stability of enclosures			
			Meets the product standard's requirements.
10.2.3.2 Verification of resistance of insulating materials to normal heat			
			Meets the product standard's requirements.
10.2.3.3 Verification of resistance of insulating materials to abnormal heat and fire due to internal electric effects			
			Meets the product standard's requirements.
10.2.4 Resistance to ultra-violet (UV) radiation			
			Meets the product standard's requirements.
10.2.5 Lifting			
			Does not apply, since the entire switchgear needs to be evaluated.
10.2.6 Mechanical impact			
			Does not apply, since the entire switchgear needs to be evaluated.
10.2.7 Inscriptions			
			Meets the product standard's requirements.
10.3 Degree of protection of ASSEMBLIES			
			Does not apply, since the entire switchgear needs to be evaluated.

10.4 Clearances and creepage distances		Meets the product standard's requirements.
10.5 Protection against electric shock		Does not apply, since the entire switchgear needs to be evaluated.
10.6 Incorporation of switching devices and components		Does not apply, since the entire switchgear needs to be evaluated.
10.7 Internal electrical circuits and connections		Is the panel builder's responsibility.
10.8 Connections for external conductors		Is the panel builder's responsibility.
10.9 Insulation properties		
10.9.2 Power-frequency electric strength		Is the panel builder's responsibility.
10.9.3 Impulse withstand voltage		Is the panel builder's responsibility.
10.9.4 Testing of enclosures made of insulating material		Is the panel builder's responsibility.
10.10 Temperature rise		The panel builder is responsible for the temperature rise calculation. Eaton will provide heat dissipation data for the devices.
10.11 Short-circuit rating		Is the panel builder's responsibility. The specifications for the switchgear must be observed.
10.12 Electromagnetic compatibility		Is the panel builder's responsibility. The specifications for the switchgear must be observed.
10.13 Mechanical function		The device meets the requirements, provided the information in the instruction leaflet (IL) is observed.

## Technical data ETIM 7.0

Low-voltage industrial components (EG000017) / Auxiliary contact block (EC000041)		
Electric engineering, automation, process control engineering / Low-voltage switch technology / Component for low-voltage switching technology / Auxiliary switch block (ecl@ss10.0.1-27-37-13-02 [AKN342013])		
Number of contacts as change-over contact		0
Number of contacts as normally open contact		0
Number of contacts as normally closed contact		2
Number of fault-signal switches		0
Rated operation current I <sub>e</sub> at AC-15, 230 V	A	6
Type of electric connection		Screw connection
Model		Top mounting
Mounting method		Front fastening
Lamp holder		None

## Approvals

Product Standards		IEC/EN 60947-5; UL 508; CSA-C22.2 No. 14-05; CSA-C22.2 No. 94-91; CE marking
UL File No.		E340491
UL Category Control No.		NISD
CSA File No.		012528_C_000
CSA Class No.		3211-03
North America Certification		UL listed, CSA certified
Degree of Protection		UL/CSA Type: -

## Dimensions

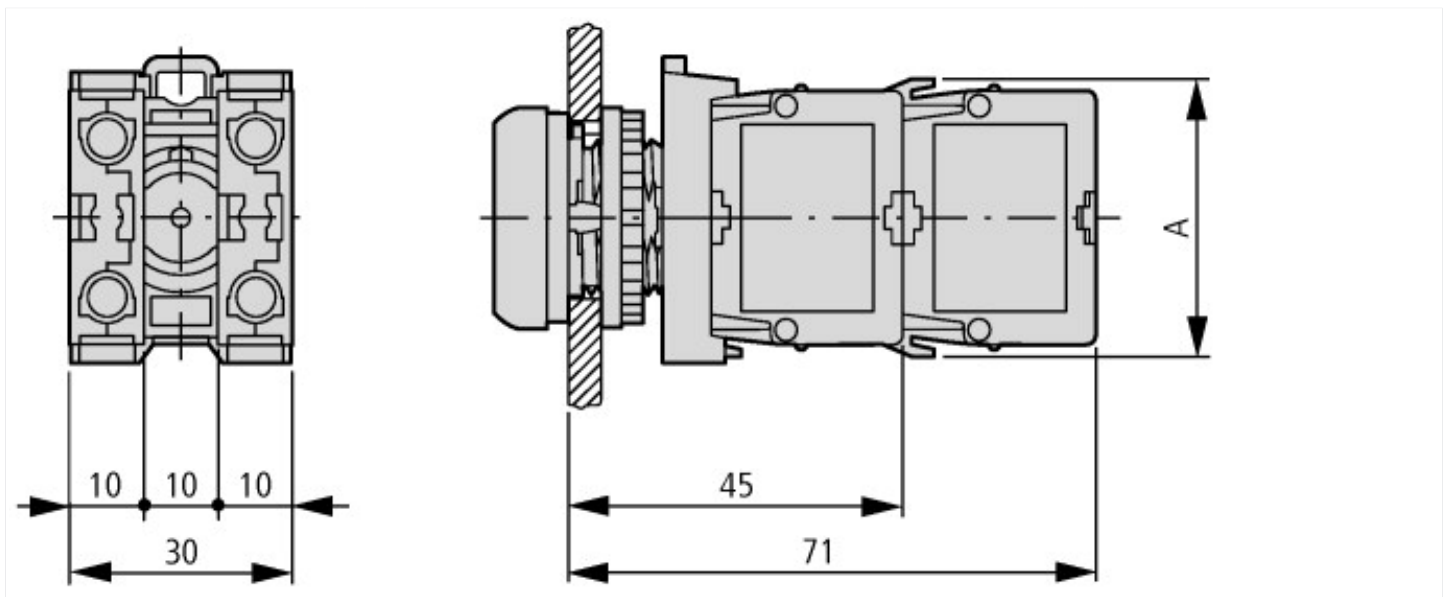

## Additional product information (links)

DGUV Test Mark Customer Information

[http://www.dguv.de/medien/dguv-test-medien/\\_pdf\\_zip\\_doc\\_ppt/agb-und-pzo/dguv\\_test\\_zeichen\\_infoblatt\\_kunden.pdf](http://www.dguv.de/medien/dguv-test-medien/_pdf_zip_doc_ppt/agb-und-pzo/dguv_test_zeichen_infoblatt_kunden.pdf)