



Door coupling rotary handle, black, lockable, size 3

Part no. NZM3-XTVDV-0-NA
Catalog No. 100677

Similar to illustration

Delivery program

Product range		Accessories
Accessories		Door coupling rotary handle
Standard/Approval		UL/CSA, IEC
Construction size		NZM3
Description		Door coupling rotary handle for operating the switch through a closed control panel door
Function		Standard, black/grey
Protection class		IP66 UL/CSA Type 4X, Type 12
Locking facility		lockable on the handle on the switch using up to 3 padlocks With door interlock
Door interlock		Not defeated in the locked OFF position. Door opens only with active rotation beyond the 0 position Can be modified such that it can be defeated from the outside using a screwdriver
Project planning information		Complete including rotary drive and coupling parts Cannot be combined with mechanical interlock For extremely narrow fittings With special short extension shaft Cannot be combined with NZM...-XDZ additional handle External warning plate/designation label can be clipped on.
For use with		NZM3, N(S)3
lockable		single

Design verification as per IEC/EN 61439

IEC/EN 61439 design verification		
10.2 Strength of materials and parts		
10.2.2 Corrosion resistance		Meets the product standard's requirements.
10.2.3.1 Verification of thermal stability of enclosures		Meets the product standard's requirements.
10.2.3.2 Verification of resistance of insulating materials to normal heat		Meets the product standard's requirements.
10.2.3.3 Verification of resistance of insulating materials to abnormal heat and fire due to internal electric effects		Meets the product standard's requirements.
10.2.4 Resistance to ultra-violet (UV) radiation		Meets the product standard's requirements.
10.2.5 Lifting		Does not apply, since the entire switchgear needs to be evaluated.
10.2.6 Mechanical impact		Does not apply, since the entire switchgear needs to be evaluated.
10.2.7 Inscriptions		Meets the product standard's requirements.
10.3 Degree of protection of ASSEMBLIES		Does not apply, since the entire switchgear needs to be evaluated.
10.4 Clearances and creepage distances		Meets the product standard's requirements.
10.5 Protection against electric shock		Does not apply, since the entire switchgear needs to be evaluated.
10.6 Incorporation of switching devices and components		Does not apply, since the entire switchgear needs to be evaluated.
10.7 Internal electrical circuits and connections		Is the panel builder's responsibility.
10.8 Connections for external conductors		Is the panel builder's responsibility.
10.9 Insulation properties		
10.9.2 Power-frequency electric strength		Is the panel builder's responsibility.
10.9.3 Impulse withstand voltage		Is the panel builder's responsibility.
10.9.4 Testing of enclosures made of insulating material		Is the panel builder's responsibility.
10.10 Temperature rise		The panel builder is responsible for the temperature rise calculation. Eaton will provide heat dissipation data for the devices.
10.11 Short-circuit rating		Is the panel builder's responsibility. The specifications for the switchgear must be observed.
10.12 Electromagnetic compatibility		Is the panel builder's responsibility. The specifications for the switchgear must be observed.

Technical data ETIM 7.0

Low-voltage industrial components (EG000017) / Handle for power circuit breaker (EC000229)

Electric engineering, automation, process control engineering / Low-voltage switch technology / Circuit breaker (LV < 1 kV) / Handle for switch devices (ecl@ss10.0.1-27-37-04-14 [AKF012014])

Lockable	Yes
Colour	Black
Suitable for emergency stop	No
With extension shaft	No
Suitable for power circuit breaker	Yes
Suitable for switch disconnecter	Yes

Approvals

Product Standards	UL489; CSA-C22.2 No. 5-09; IEC60947, CE marking
UL File No.	E140305
UL Category Control No.	DIHS
CSA File No.	022086
CSA Class No.	1437-01
North America Certification	UL listed, CSA certified
Specially designed for North America	Rotary handle with additional 4th position, beyond OFF, to release door interlock.
Degree of Protection	IEC: IP66, UL/CSA Type 4X, 12

Dimensions

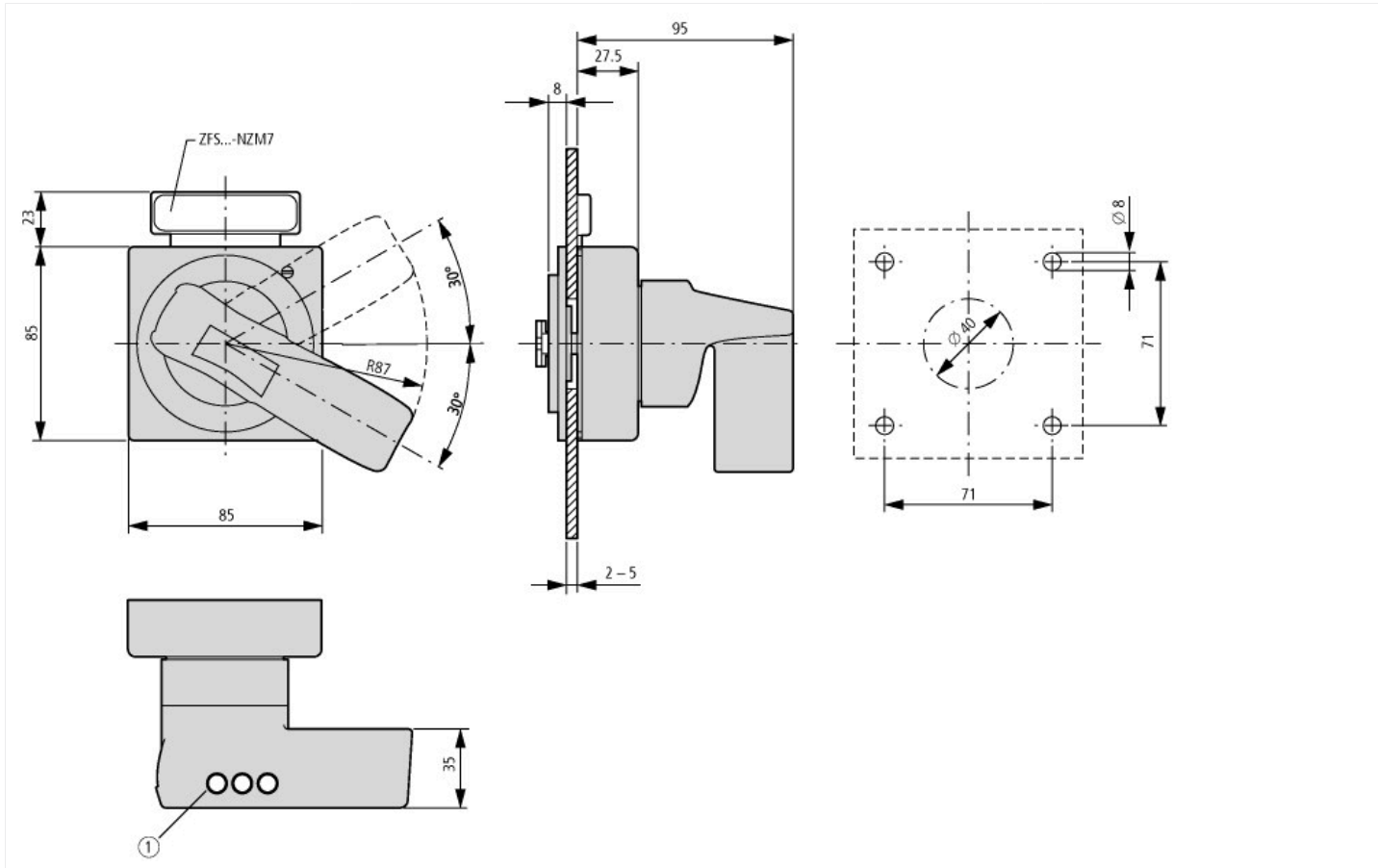

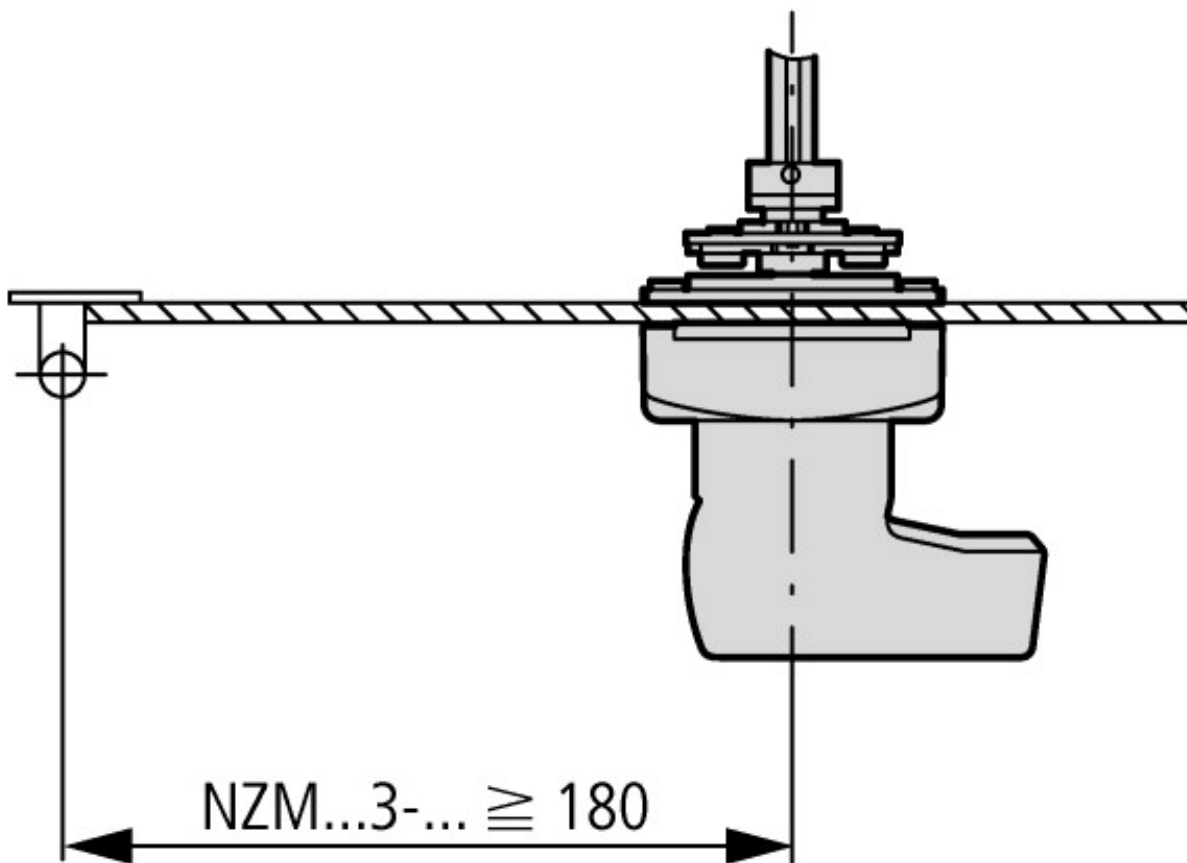
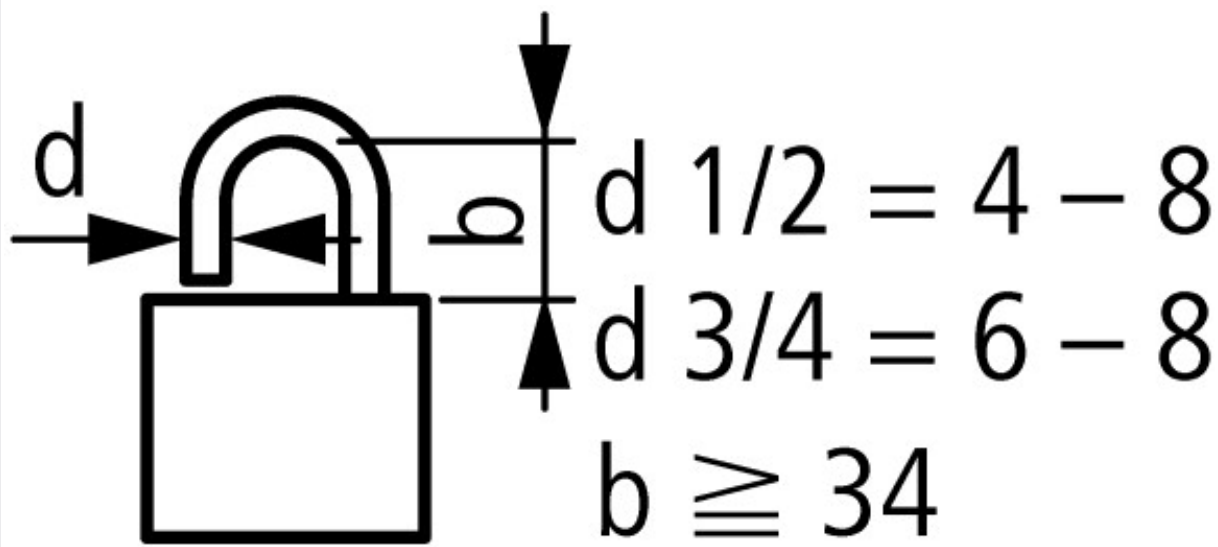

Minimum door coupling rotary handle clearance from door pivot point

Additional product information (links)

IL01222001Z (AWA1230-2124) Door coupling rotary handle (short)

IL01222001Z (AWA1230-2124) Door coupling rotary handle (short) ftp://ftp.moeller.net/DOCUMENTATION/AWA_INSTRUCTIONS/IL01222001Z2019_10.pdf