



Short-circuit protective breaker, I_u 16 A, I_{rm} 248 A, Screw terminals, Also suitable for motors with efficiency class IE3.



Part no. **PKM0-16**
 Catalog No. **044502**
 Alternate Catalog No. **XTPM016BNL**

Delivery program

Product range				PKM0 motor protective circuit-breakers up to 32 A
Basic function				Short-circuit protective device only
Notes				Also suitable for motors with efficiency class IE3.
Connection technique				Screw terminals
Contact sequence				
Max. motor rating				
AC-3				
220 V 230 V 240 V	P	kW		4
380 V 400 V 415 V	P	kW		7.5
440 V	P	kW		9
500 V	P	kW		9
660 V 690 V	P	kW		12.5
Rated uninterrupted current	I _u	A		16
Setting range				
short-circuit release				
max.	I _{rm}	A		248

Notes An appropriate overload relay must be fitted to protect motors against overload.
 Can be snapped on to IEC/EN 60715 top-hat rail with 7.5 or 15 mm height.
 Refer to catalog CA034001DE for the allocation of short circuit protection and contactor
 When using the PKM0 as short-circuit protection for motors with heavy starting duty, the rated operational current I_e must be over-dimensioned during engineering with the following factors:
 CLASS 5: 1,0
 CLASS 10: 1,0
 CLASS 15: 1,22
 CLASS 20: 1,41
 CLASS 25: 1,58
 CLASS 30: 1,73
 CLASS 35: 1,89
 CLASS 40: 2,0

Technical data

General				
Standards				IEC/EN 60947, VDE 0660
Climatic proofing				Damp heat, constant, to IEC 60068-2-78 Damp heat, cyclic, to IEC 60068-2-30
Ambient temperature				
Storage		°C		- 40 - 80
Open		°C		-25 - +55
Enclosed		°C		- 25 - 40

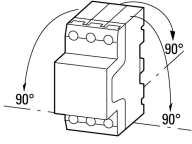
Mounting position			
Direction of incoming supply			as required
Degree of protection			
Device			IP20
Terminations			IP00
Protection against direct contact when actuated from front (EN 50274)			Finger and back-of-hand proof
Mechanical shock resistance half-sinusoidal shock 10 ms to IEC 60068-2-27		g	25
Altitude		m	Max. 2000
Terminal capacity main cable			
Screw terminals			
Solid		mm ²	1 x (1 - 6) 2 x (1 - 6)
Flexible with ferrule to DIN 46228		mm ²	1 x (1 - 6) 2 x (1 - 6)
Solid or stranded		AWG	18 - 10
Stripping length		mm	10
Specified tightening torque for terminal screws			
Main cable		Nm	1.7
Control circuit cables		Nm	1

Main conducting paths

Rated impulse withstand voltage	U_{imp}	V AC	6000
Overvoltage category/pollution degree			III/3
Rated operational voltage	U_e	V AC	690
Rated uninterrupted current = rated operational current	$I_u = I_e$	A	16
Rated frequency	f	Hz	40 - 60
Current heat loss (3 pole at operating temperature)		W	6.43
Impedance per pole		mΩ	8
Lifespan, mechanical	Operations	$\times 10^6$	0.1
Lifespan, electrical (AC-3 at 400 V)			
Lifespan, electrical	Operations	$\times 10^6$	0.1
Max. operating frequency		Ops/h	40
Motor switching capacity			
AC-3 (up to 690V)		A	16
DC-5 (up to 250V)		A	16 (3 contacts in series)

Trip blocks

Temperature compensation			
to IEC/EN 60947, VDE 0660		°C	- 5 ... 40
Operating range		°C	- 25 ... 55
Temperature compensation residual error for T > 40 °C			≤ 0.25 %/K
short-circuit release			Basic device, fixed: 15.5 x I_u
Short-circuit release tolerance			± 20%

Design verification as per IEC/EN 61439

Technical data for design verification			
Rated operational current for specified heat dissipation	I_n	A	16
Heat dissipation per pole, current-dependent	P_{vid}	W	2.14
Equipment heat dissipation, current-dependent	P_{vid}	W	6.43
Static heat dissipation, non-current-dependent	P_{vs}	W	0
Heat dissipation capacity	P_{diss}	W	0
Operating ambient temperature min.		°C	-25
Operating ambient temperature max.		°C	55
IEC/EN 61439 design verification			

10.2 Strength of materials and parts			
10.2.2 Corrosion resistance			Meets the product standard's requirements.
10.2.3.1 Verification of thermal stability of enclosures			Meets the product standard's requirements.
10.2.3.2 Verification of resistance of insulating materials to normal heat			Meets the product standard's requirements.
10.2.3.3 Verification of resistance of insulating materials to abnormal heat and fire due to internal electric effects			Meets the product standard's requirements.
10.2.4 Resistance to ultra-violet (UV) radiation			Meets the product standard's requirements.
10.2.5 Lifting			Does not apply, since the entire switchgear needs to be evaluated.
10.2.6 Mechanical impact			Does not apply, since the entire switchgear needs to be evaluated.
10.2.7 Inscriptions			Meets the product standard's requirements.
10.3 Degree of protection of ASSEMBLIES			Does not apply, since the entire switchgear needs to be evaluated.
10.4 Clearances and creepage distances			Meets the product standard's requirements.
10.5 Protection against electric shock			Does not apply, since the entire switchgear needs to be evaluated.
10.6 Incorporation of switching devices and components			Does not apply, since the entire switchgear needs to be evaluated.
10.7 Internal electrical circuits and connections			Is the panel builder's responsibility.
10.8 Connections for external conductors			Is the panel builder's responsibility.
10.9 Insulation properties			
10.9.2 Power-frequency electric strength			Is the panel builder's responsibility.
10.9.3 Impulse withstand voltage			Is the panel builder's responsibility.
10.9.4 Testing of enclosures made of insulating material			Is the panel builder's responsibility.
10.10 Temperature rise			The panel builder is responsible for the temperature rise calculation. Eaton will provide heat dissipation data for the devices.
10.11 Short-circuit rating			Is the panel builder's responsibility. The specifications for the switchgear must be observed.
10.12 Electromagnetic compatibility			Is the panel builder's responsibility. The specifications for the switchgear must be observed.
10.13 Mechanical function			The device meets the requirements, provided the information in the instruction leaflet (IL) is observed.

Technical data ETIM 7.0

Low-voltage industrial components (EG000017) / Motor protection circuit-breaker (EC000074)			
Electric engineering, automation, process control engineering / Low-voltage switch technology / Circuit breaker (LV < 1 kV) / Motor protection circuit-breaker (ecl@ss10.0.1-27-37-04-01 [AGZ529016])			
Overload release current setting	A		0 - 0
Adjustment range undelayed short-circuit release	A		248 - 248
With thermal protection			No
Phase failure sensitive			No
Switch off technique			Magnetic
Rated operating voltage	V		690 - 690
Rated permanent current I _u	A		16
Rated operation power at AC-3, 230 V	kW		4
Rated operation power at AC-3, 400 V	kW		7.5
Type of electrical connection of main circuit			Screw connection
Type of control element			Turn button
Device construction			Built-in device fixed built-in technique
With integrated auxiliary switch			No
With integrated under voltage release			No
Number of poles			3
Rated short-circuit breaking capacity I _{cu} at 400 V, AC	kA		50
Degree of protection (IP)			IP20
Height	mm		93
Width	mm		45
Depth	mm		76

Approvals

Specially designed for North America			No
--------------------------------------	--	--	----

Characteristics

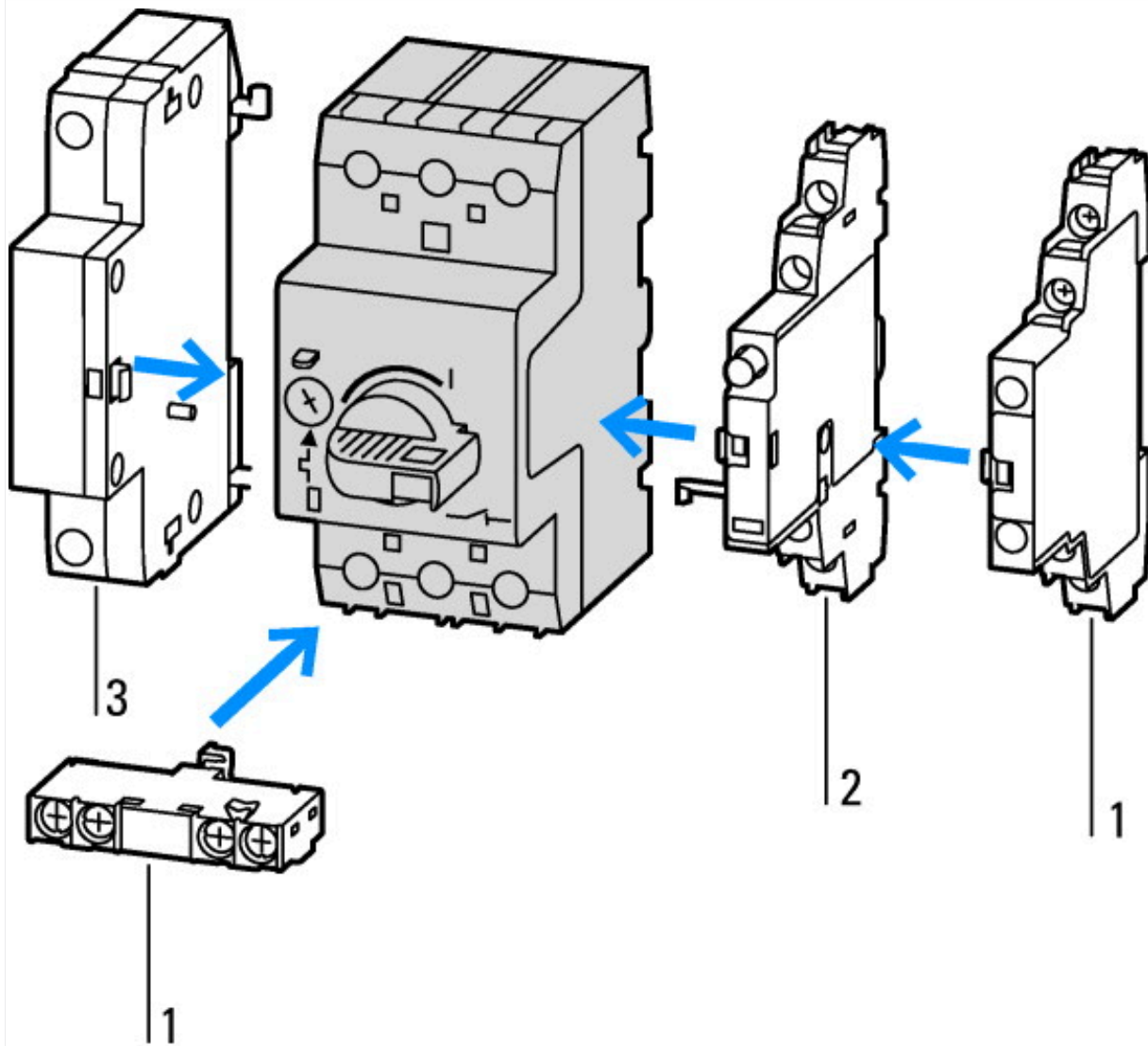

- 1: Standard auxiliary contact
- 2: Trip-indicating auxiliary contact
- 3: Shunt releases, undervoltage releases

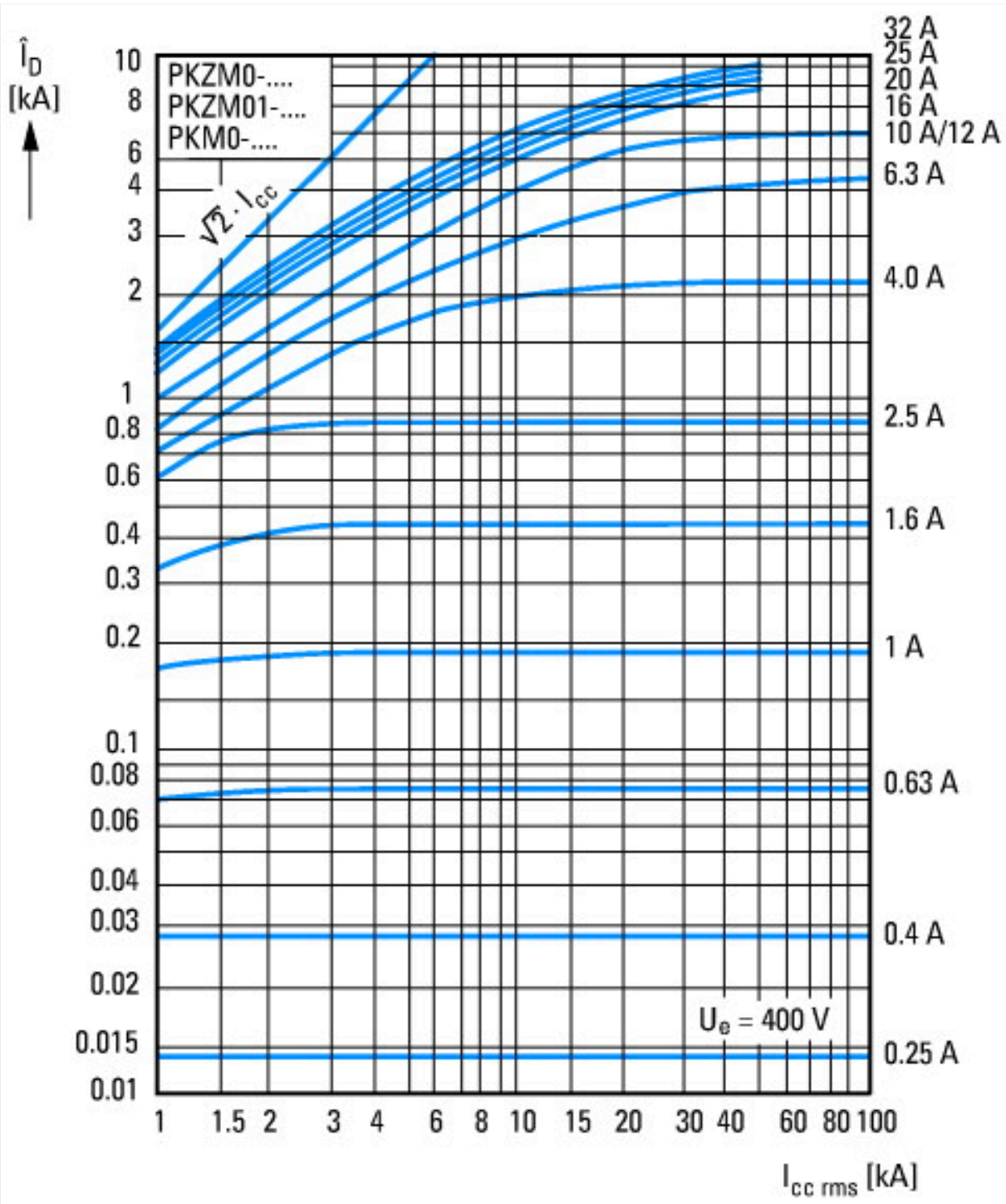

Let-through current

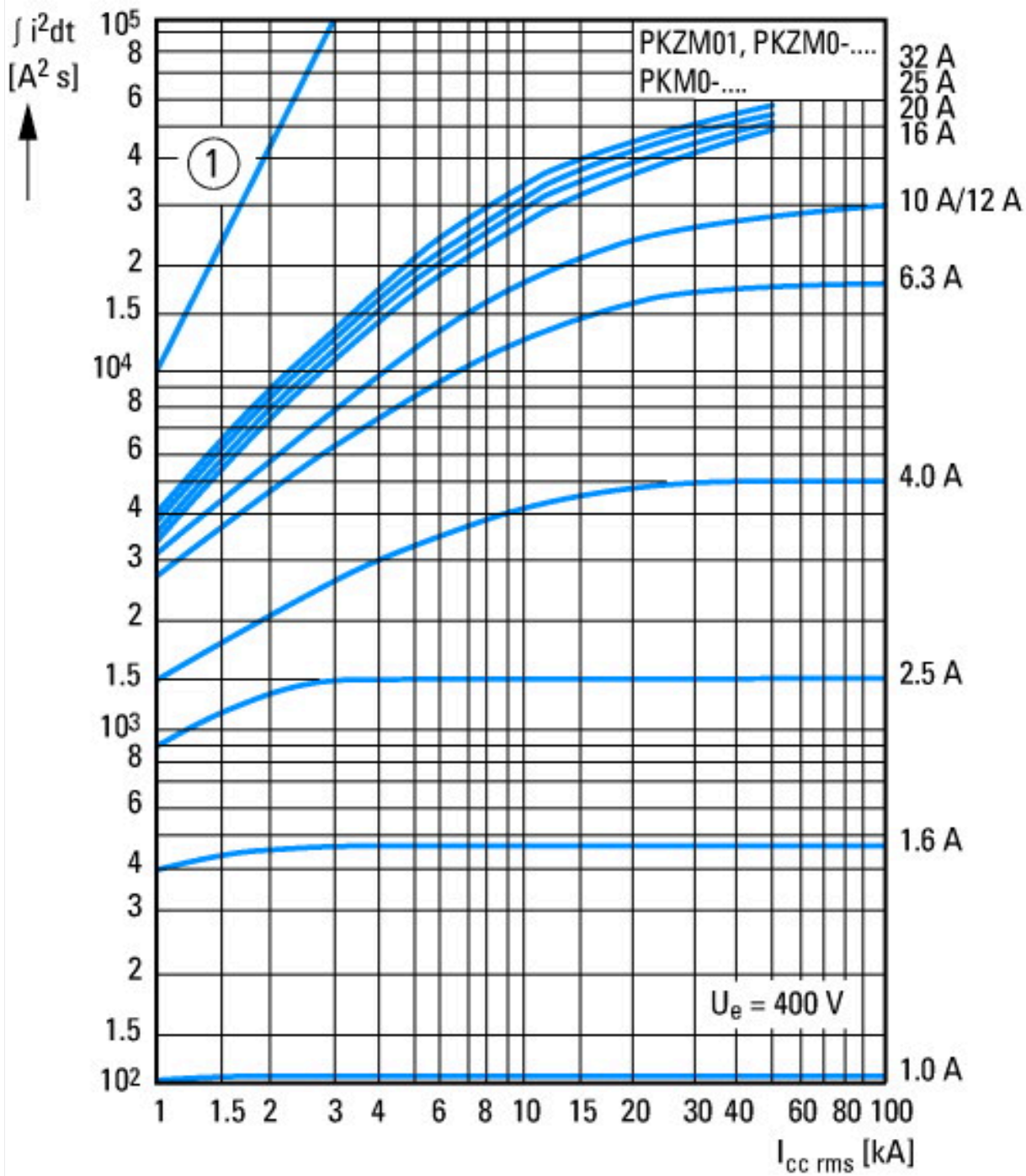

① 1 half-cycle
Let-through energy

Dimensions

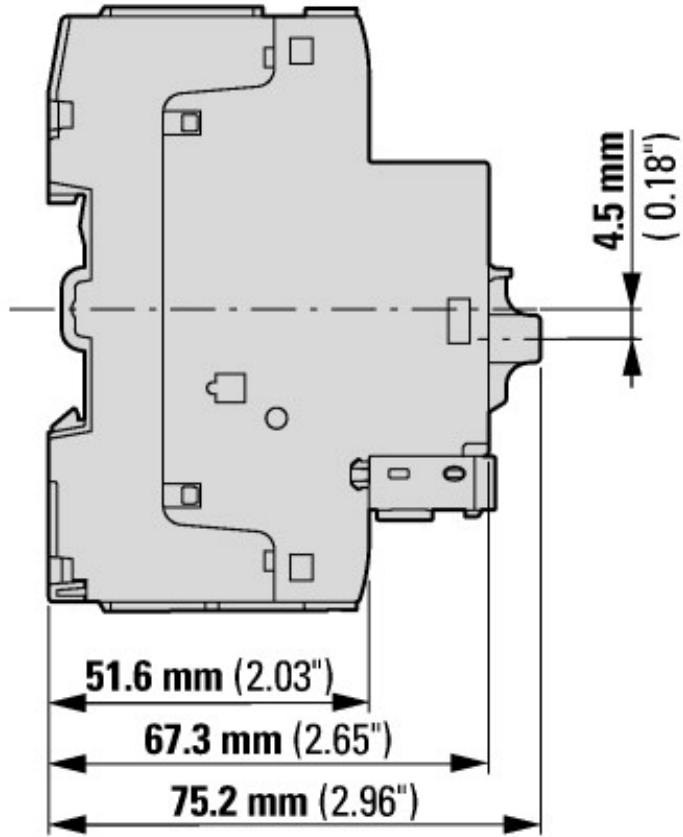
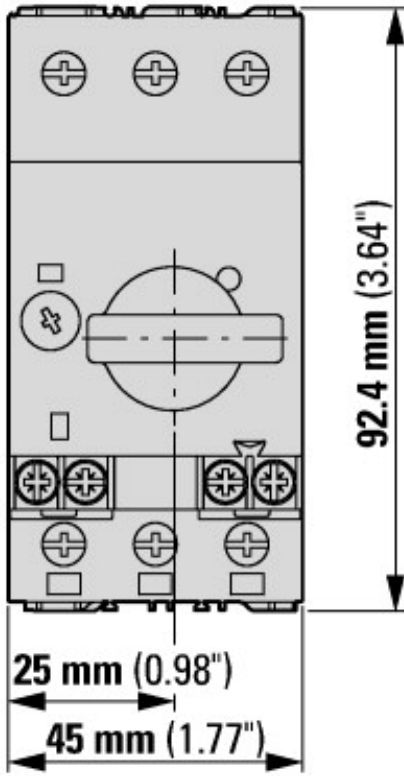

Motor-protective circuit-breaker with standard auxiliary contact
 PKZM0-...(+NHI-E-...-PKZ0)
 PKZM0-...-T(+NHI-E-...-PKZ0)
 PKM0-...(+NHI-E-...-PKZ0)

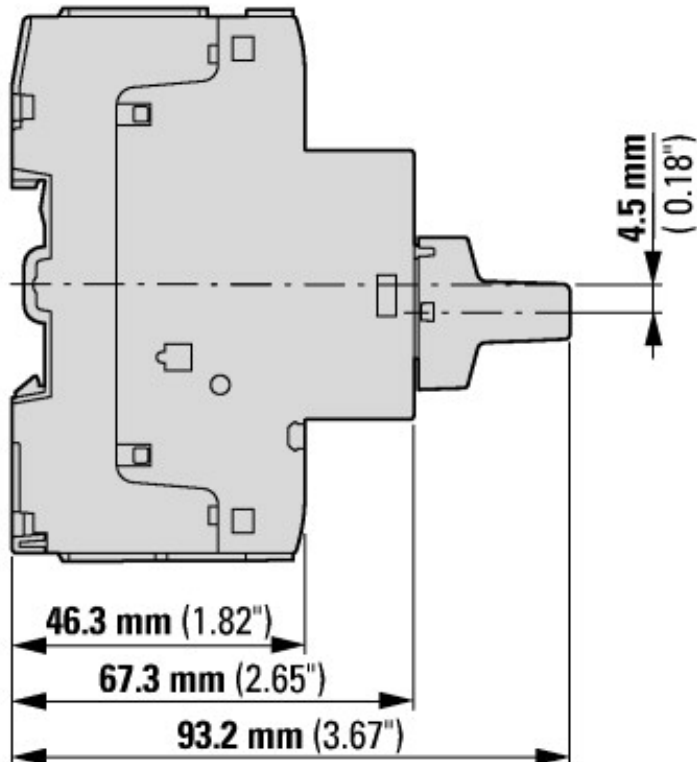
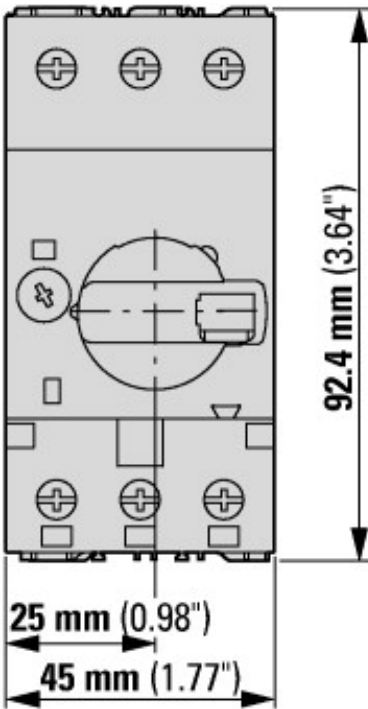

Motor-protective circuit-breakers with lockable rotary handles
 PKZM0-...+AK-PKZ0

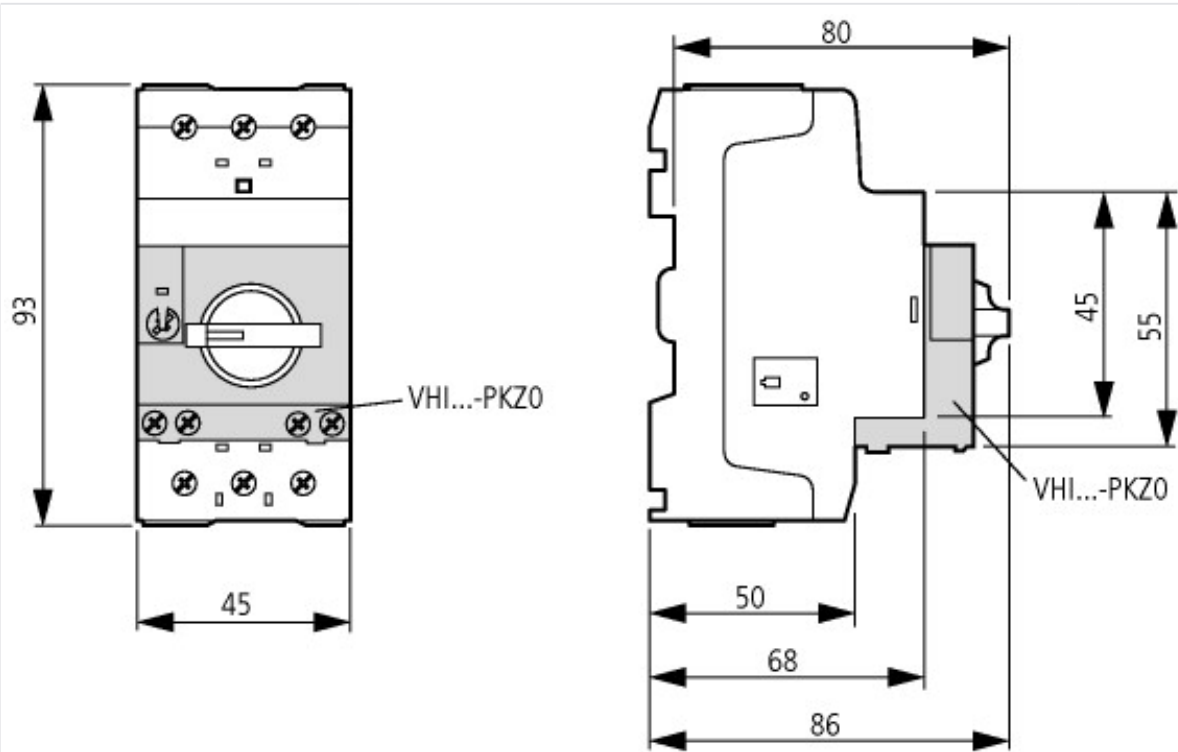

Motor-protective circuit-breakers with early-make auxiliary contacts
PKZM0-...+VHI-...-PKZ0

Additional product information (links)

Schaltvermögen	http://de.ecat.eaton.com/flip-cat/?edition=HPLTEv1&startpage=
Motor starters and "Special Purpose Ratings" for the North American market	http://www.eaton.eu/ecm/groups/public/@pub/@europe/@electrical/documents/content/pct_3258146.pdf
Busbar Component Adapters for modern Industrial control panels	http://www.moeller.net/binary/ver_techpapers/ver960en.pdf