



**Contactor, 380 V 50/60 Hz, 3 pole, 380 V 400 V, 4 kW, Contacts N/O = Normally open= 1 N/O, Screw terminals, AC operation**



**Part no. DILEM-10(380V50/60HZ)**  
**Catalog No. 032241**  
**Alternate Catalog No. XTMC9A10AR**

**Delivery program**

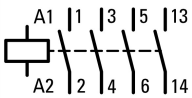
|   |                |    |  |  |
|---|----------------|----|--|--|
| Product range   |                |    |  | Contactors   |
| Application   |                |    |  | Mini Contactors for Motors and Resistive Loads   |
| Subrange  |                |    |  | DILEM contactors   |
| Utilization category                                      |                |    |  | AC-1: Non-inductive or slightly inductive loads, resistance furnaces<br>AC-3/AC-3e: Normal AC induction motors: Starting, switching off while running<br>AC-4: Normal AC induction motors: starting, plugging, reversing, inching                |
| Notes   |                |    |  | <br>Also suitable for motors with efficiency class IE3.<br>IE3-ready devices are identified by the logo on their packaging.<br>Also tested according to AC-3e. |
| Connection technique                                      |                |    |  | Screw terminals  |
| Description   |                |    |  | With auxiliary contact   |
| Number of poles   |                |    |  | 3 pole   |
| <b>Rated operational current</b>                          |                |    |  |  |
| AC-3  |                |    |  |  |
| 380 V 400 V   | $I_e$          | A  |  | 9  |
| AC-1  |                |    |  |  |
| Conventional free air thermal current, 3 pole, 50 - 60 Hz |                |    |  |  |
| Open  |                |    |  |  |
| at 40 °C  | $I_{th} = I_e$ | A  |  | 22   |
| <b>Max. rating for three-phase motors, 50 - 60 Hz</b>     |                |    |  |  |
| AC-3  |                |    |  |  |
| 220 V 230 V   | P              | kW |  | 2.2  |
| 380 V 400 V   | P              | kW |  | 4  |
| 660 V 690 V   | P              | kW |  | 4  |
| AC-4  |                |    |  |  |
| 220 V 230 V   | P              | kW |  | 1.5  |
| 380 V 400 V   | P              | kW |  | 3  |
| 660 V 690 V   | P              | kW |  | 3  |
| <b>Contacts</b>   |                |    |  |  |
| N/O = Normally open                                       |                |    |  | 1 N/O  |
| Contact sequence  |                |    |  |    |
| For use with  |                |    |  | ...DILEM<br>...DILE  |
| Actuating voltage   |                |    |  | 380 V 50/60 Hz   |
| Voltage AC/DC   |                |    |  | AC operation   |

**Technical data**

|                                     |            |               |  |                                 |
|-------------------------------------|------------|---------------|--|---------------------------------|
| <b>General</b>                      |            |               |  |                                 |
| Standards                           |            |               |  | IEC/EN 60947, VDE 0660, CSA, UL |
| Lifespan, mechanical; Coil 50/60 Hz | Operations | $\times 10^6$ |  | 7                               |
| Lifespan, mechanical                | Operations | $\times 10^6$ |  | 10                              |

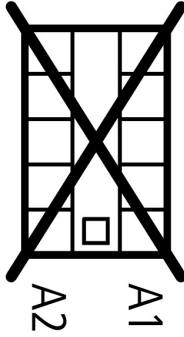
|   |           |                 |                                      |  |
|---|-----------|-----------------|--------------------------------------|--|
| Maximum operating frequency   |           |                 |                                      |  |
| Mechanical  |           | Ops./h          | 9000                                 |  |
| electrical (Contactors without overload relay)                        |           | Operations/h    | See characteristic curves            |  |
| Climatic proofing   |           |                 |                                      | Damp heat, constant, to IEC 60068-2-78<br>Damp heat, cyclic, to IEC 60068-2-30     |
| Ambient temperature   |           |                 |                                      |  |
| Open  |           | °C              | -25 - +50                            |  |
| Enclosed  |           | °C              | - 25 - 40                            |  |
| Storage   |           | °C              |                                      |  |
| Min. ambient temperature, storage                                     |           | °C              | - 40                                 |  |
| Ambient temperature, storage max.                                     |           | °C              | + 80                                 |  |
| Mounting position   |           |                 |                                      | As required, except vertical with terminals A1/A2 at the bottom                    |
| Mounting position   |           |                 |                                      |  |
| Mechanical shock resistance (IEC/EN 60068-2-27)                       |           |                 |                                      |  |
| Half-sinusoidal shock, 10 ms  |           |                 |                                      |  |
| Basic unit without auxiliary contact module                           |           |                 |                                      |  |
| Main contacts, make contacts  |           | g               | 10                                   |  |
| Main contacts Make/break contacts                                     |           | g               |                                      |  |
| Make  |           | g               | 8                                    |  |
| Basic unit with auxiliary contact module                              |           |                 |                                      |  |
| Main contacts make contact  |           | g               |                                      |  |
| Make  |           | g               | 10                                   |  |
| Auxiliary contacts Make/break contacts                                |           | g               | 20 / 20                              |  |
| Degree of Protection  |           |                 |                                      | IP20   |
| Protection against direct contact when actuated from front (EN 50274) |           |                 |                                      | Finger and back-of-hand proof  |
| Altitude  |           | m               | Max. 2000                            |  |
| Weight  |           | kg              | 0.17                                 |  |
| Terminal capacity of auxiliary and main contacts                      |           |                 |                                      |  |
| Screw terminals   |           |                 |                                      |  |
| Solid   |           | mm <sup>2</sup> | 1 x (0.75 - 2.5)<br>2 x (0.75 - 2.5) |  |
| Flexible with ferrule   |           | mm <sup>2</sup> | 1 x (0.75 - 1.5)<br>2 x (0.75 - 1.5) |  |
| Solid or stranded   |           | AWG             | 18 - 14                              |  |
| Stripping length  |           | mm              | 8                                    |  |
| Terminal screw  |           |                 | M3.5                                 |  |
| Pozidriv screwdriver  |           | Size            | 2                                    |  |
| Standard screwdriver  |           | mm              | 0.8 x 5.5<br>1 x 6                   |  |
| Max. tightening torque  |           | Nm              | 1.2                                  |  |
| <b>Main conducting paths</b>  |           |                 |                                      |  |
| Rated impulse withstand voltage                                       | $U_{imp}$ | V AC            | 6000                                 |  |
| Overvoltage category/pollution degree                                 |           |                 | III/3                                |  |
| Rated insulation voltage  | $U_i$     | V AC            | 690                                  |  |
| Rated operational voltage   | $U_e$     | V AC            | 690                                  |  |
| Safe isolation to EN 61140  |           |                 |                                      |  |
| between coil and contacts   |           | V AC            | 300                                  |  |
| between the contacts  |           | V AC            | 300                                  |  |

|   |       |   |     |
|---|-------|---|-----|
| Making capacity (cos φ to IEC/EN 60947) |       | A | 110 |
| Breaking capacity                       |       |   |     |
| 220 V 230 V                             |       | A | 90  |
| 380 V 400 V                             |       | A | 90  |
| 500 V                                   |       | A | 64  |
| 660 V 690 V                             |       | A | 42  |
| Short-circuit protection maximum fuse   |       |   |     |
| Type "2", 500 V                         | gL/gG | A | 10  |
| Type "1", 500 V                         | gL/gG | A | 20  |

## AC

|   |                |     |   |
|---|----------------|-----|---|
| AC-1  |                |     |   |
| Rated operational current                                 |                |     |   |
| Conventional free air thermal current, 3 pole, 50 - 60 Hz |                |     |   |
| Open  |                |     |   |
| at 40 °C  | $I_{th} = I_e$ | A   | 22  |
| at 50 °C  | $I_{th} = I_e$ | A   | 20  |
| enclosed  | $I_{th}$       | A   | 16  |
| Notes   |                |     | At maximum permissible ambient air temperature.                                       |
| Conventional free air thermal current, 1 pole             |                |     |   |
| Notes   |                |     | At maximum permissible ambient air temperature.                                       |
| open  | $I_{th}$       | A   | 50  |
| enclosed  | $I_{th}$       | A   | 40  |
| AC-3  |                |     |   |
| Rated operational current                                 |                |     |   |
| Open, 3-pole: 50 – 60 Hz                                  |                |     |   |
| Notes   |                |     | At maximum permissible ambient temperature (open.)<br>Also tested according to AC-3e. |
| 220 V 230 V   | $I_e$          | A   | 9   |
| 240 V   | $I_e$          | A   | 9   |
| 380 V 400 V   | $I_e$          | A   | 9   |
| 415 V   | $I_e$          | A   | 9   |
| 440V  | $I_e$          | A   | 9   |
| 500 V   | $I_e$          | A   | 6.4   |
| 660 V 690 V   | $I_e$          | A   | 4.8   |
| Motor rating  | P              | kWh |   |
| 220 V 230 V   | P              | kW  | 2.2   |
| 240V  | P              | kW  | 2.5   |
| 380 V 400 V   | P              | kW  | 4   |
| 415 V   | P              | kW  | 4.3   |
| 440 V   | P              | kW  | 4.6   |
| 500 V   | P              | kW  | 4   |
| 660 V 690 V   | P              | kW  | 4   |
| AC-4  |                |     |   |
| Rated operational current                                 |                |     |   |
| Open, 3-pole: 50 – 60 Hz                                  |                |     |   |
| Notes   |                |     | At maximum permissible ambient air temperature.                                       |
| 220 V 230 V   | $I_e$          | A   | 6.6   |
| 240 V   | $I_e$          | A   | 6.6   |
| 380 V 400 V   | $I_e$          | A   | 6.6   |
| 415 V   | $I_e$          | A   | 6.6   |
| 440 V   | $I_e$          | A   | 6.6   |
| 500 V   | $I_e$          | A   | 5   |
| 660 V 690 V   | $I_e$          | A   | 3.4   |
| Motor rating  | P              | kWh |   |

|             |   |    |     |
|-------------|---|----|-----|
| 220 V 230 V | P | kW | 1.5 |
| 240 V       | P | kW | 1.8 |
| 380 V 400 V | P | kW | 3   |
| 415 V       | P | kW | 3.1 |
| 440 V       | P | kW | 3.3 |
| 500 V       | P | kW | 3   |
| 660 V 690 V | P | kW | 3   |

## DC

|                                |       |   |    |
|--------------------------------|-------|---|----|
| Rated operational current open |       |   |    |
| DC-1                           |       |   |    |
| 12 V                           | $I_e$ | A | 20 |
| 24 V                           | $I_e$ | A | 20 |
| 60 V                           | $I_e$ | A | 20 |
| 110 V                          | $I_e$ | A | 20 |
| 220 V                          | $I_e$ | A | 20 |

## Magnet systems

|   |         |         |            |
|---|---------|---------|------------|
| Voltage tolerance                                 |         |         |            |
| AC operated                                       |         |         |            |
| Dual-frequency coil 50/60 Hz                      | Pick-up | $x U_c$ | 0.85 - 1.1 |
| Power consumption                                 |         |         |            |
| AC operation                                      |         |         |            |
| Dual-frequency coil 50/60 Hz at 50 Hz             | Pick-up | VA      | 30         |
| Dual-frequency coil 50/60 Hz at 50 Hz             | Pick-up | W       | 26         |
| Dual-frequency coil 50/60 Hz at 50 Hz             | Sealing | VA      | 5.4        |
| Dual-frequency coil 50/60 Hz at 50 Hz             | Sealing | W       | 1.8        |
| Dual-frequency coil 50/60 Hz at 60 Hz             | Pick-up | VA      | 29         |
| Dual-frequency coil 50/60 Hz at 60 Hz             | Pick-up | W       | 24         |
| Dual-frequency coil 50/60 Hz at 60 Hz             | Sealing | VA      | 3.9        |
| Dual-frequency coil 50/60 Hz at 60 Hz             | Sealing | W       | 1.8        |
| Duty factor                                       |         | % DF    | 100        |
| Switching times at 100 % $U_c$                    |         |         |            |
| Make contact                                      |         | ms      |            |
| Closing delay                                     |         | ms      |            |
| Closing delay min.                                |         | ms      | 14         |
| Closing delay max.                                |         | ms      | 21         |
| Opening delay                                     |         | ms      |            |
| Opening delay min.                                |         | ms      | 8          |
| Opening delay max.                                |         | ms      | 18         |
| Closing delay with top mounting auxiliary contact |         | ms      | 45         |
| Reversing contactors                              |         |         |            |
| Changeover time at 110 % $U_c$                    |         |         |            |
| Changeover time min.                              |         | ms      | 16         |
| Changeover time max.                              |         | ms      | 21         |
| Arcing time at 690 V AC                           |         | ms      | 12         |

## Current heat losses (3- or 4-pole)

|                        |  |    |      |
|------------------------|--|----|------|
| at $I_{th}$ , 50 °C    |  | W  | 5.9  |
| at $I_e$ to AC-3/400 V |  | W  | 1.2  |
| Impedance per pole     |  | mΩ | 9.18 |

## Auxiliary contacts

|  |           |      |       |
|--|-----------|------|-------|
| Positive operating contacts to EN 60947-5-1 appendix L, including auxiliary contact module |           |      | Yes   |
| Rated impulse withstand voltage  | $U_{imp}$ | V AC | 6000  |
| Overvoltage category/pollution degree  |           |      | III/3 |
| Rated insulation voltage   | $U_i$     | V AC | 690   |
| Rated operational voltage  | $U_e$     | V AC | 600   |
| Safe isolation to EN 61140   |           |      |       |

|   |              |               |  |
|---|--------------|---------------|--|
| between coil and auxiliary contacts                   |              | V AC          | 300  |
| between the auxiliary contacts                        |              | V AC          | 300  |
| <b>Rated operational current</b>                      |              |               |  |
| <b>AC-15</b>  |              |               |  |
| 220 V 240 V   | $I_e$        | A             | 6  |
| 380 V 415 V   | $I_e$        | A             | 3  |
| 500 V   | $I_e$        | A             | 1.5  |
| <b>DC L/R <math>\leq</math> 15 ms</b>                 |              |               |  |
| Contacts in series:                                   |              | A             |  |
| 1   | 24 V         | A             | 2.5  |
| 2   | 60 V         | A             | 2.5  |
| 3   | 100 V        | A             | 1.5  |
| 3   | 220 V        | A             | 0.5  |
| Conv. thermal current                                 | $I_{th}$     | A             | 10   |
| Control circuit reliability                           | Failure rate | $\lambda$     | $<10^{-8}$ , < one failure at 100 million operations<br>(at $U_e = 24$ V DC, $U_{min} = 17$ V, $I_{min} = 5.4$ mA) |
| <b>Component lifespan at <math>U_e = 240</math> V</b> |              |               |  |
| AC-15   | Operations   | $\times 10^6$ | 0.2  |
| <b>DC current</b>                                     |              |               |  |
| L/R = 50 ms: 2 contacts in series at $I_e = 0.5$ A    | Operations   | $\times 10^6$ | 0.15   |
| Notes   |              |               | Switch-on and switch-off conditions based on DC-13, time constant as specified                                     |
| <b>Short-circuit rating without welding</b>           |              |               |  |
| <b>Maximum overcurrent protective device</b>          |              |               |  |
| Short-circuit protection only                         |              |               | PKZM0-4  |
| <b>Short-circuit protection maximum fuse</b>          |              |               |  |
| 500 V   |              | A gG/gL       | 6  |
| 500 V   |              | A fast        | 10   |
| Current heat loss at a load of $I_{th}$ per contact   |              | W             | 1.1  |

### Rating data for approved types

|                                     |  |      |      |
|-------------------------------------|--|------|------|
| <b>Switching capacity</b>           |  |      |      |
| <b>Maximum motor rating</b>         |  |      |      |
| <b>Three-phase</b>                  |  |      |      |
| 200 V<br>208 V                      |  | HP   | 2    |
| 230 V<br>240 V                      |  | HP   | 3    |
| 460 V<br>480 V                      |  | HP   | 5    |
| 575 V<br>600 V                      |  | HP   | 5    |
| <b>Single-phase</b>                 |  |      |      |
| 115 V<br>120 V                      |  | HP   | 0.5  |
| 230 V<br>240 V                      |  | HP   | 1.5  |
| General use                         |  | A    | 15   |
| <b>Auxiliary contacts</b>           |  |      |      |
| <b>Pilot Duty</b>                   |  |      |      |
| AC operated                         |  |      | A600 |
| DC operated                         |  |      | P300 |
| <b>General Use</b>                  |  |      |      |
| AC                                  |  | V    | 600  |
| AC                                  |  | A    | 10   |
| DC                                  |  | V    | 250  |
| DC                                  |  | A    | 0.5  |
| <b>Short Circuit Current Rating</b> |  |      |      |
| Basic Rating                        |  | SCCR |      |

|           |    |    |
|-----------|----|----|
| SCCR      | kA | 5  |
| max. Fuse | A  | 45 |

## Design verification as per IEC/EN 61439

| Technical data for design verification   |            |    |  |
|--|------------|----|--|
| Rated operational current for specified heat dissipation   | $I_n$      | A  | 9  |
| Heat dissipation per pole, current-dependent   | $P_{vid}$  | W  | 0.4  |
| Equipment heat dissipation, current-dependent  | $P_{vid}$  | W  | 1.2  |
| Static heat dissipation, non-current-dependent   | $P_{vs}$   | W  | 1.8  |
| Heat dissipation capacity  | $P_{diss}$ | W  | 0  |
| Operating ambient temperature min.   |            | °C | -25  |
| Operating ambient temperature max.   |            | °C | 50   |
| IEC/EN 61439 design verification   |            |    |  |
| 10.2 Strength of materials and parts   |            |    |  |
| 10.2.2 Corrosion resistance  |            |    | Meets the product standard's requirements.   |
| 10.2.3.1 Verification of thermal stability of enclosures   |            |    | Meets the product standard's requirements.   |
| 10.2.3.2 Verification of resistance of insulating materials to normal heat   |            |    | Meets the product standard's requirements.   |
| 10.2.3.3 Verification of resistance of insulating materials to abnormal heat and fire due to internal electric effects |            |    | Meets the product standard's requirements.   |
| 10.2.4 Resistance to ultra-violet (UV) radiation   |            |    | Meets the product standard's requirements.   |
| 10.2.5 Lifting   |            |    | Does not apply, since the entire switchgear needs to be evaluated.   |
| 10.2.6 Mechanical impact   |            |    | Does not apply, since the entire switchgear needs to be evaluated.   |
| 10.2.7 Inscriptions  |            |    | Meets the product standard's requirements.   |
| 10.3 Degree of protection of ASSEMBLIES  |            |    | Does not apply, since the entire switchgear needs to be evaluated.   |
| 10.4 Clearances and creepage distances   |            |    | Meets the product standard's requirements.   |
| 10.5 Protection against electric shock   |            |    | Does not apply, since the entire switchgear needs to be evaluated.   |
| 10.6 Incorporation of switching devices and components   |            |    | Does not apply, since the entire switchgear needs to be evaluated.   |
| 10.7 Internal electrical circuits and connections  |            |    | Is the panel builder's responsibility.   |
| 10.8 Connections for external conductors   |            |    | Is the panel builder's responsibility.   |
| 10.9 Insulation properties   |            |    |  |
| 10.9.2 Power-frequency electric strength   |            |    | Is the panel builder's responsibility.   |
| 10.9.3 Impulse withstand voltage   |            |    | Is the panel builder's responsibility.   |
| 10.9.4 Testing of enclosures made of insulating material   |            |    | Is the panel builder's responsibility.   |
| 10.10 Temperature rise   |            |    | The panel builder is responsible for the temperature rise calculation. Eaton will provide heat dissipation data for the devices. |
| 10.11 Short-circuit rating   |            |    | Is the panel builder's responsibility. The specifications for the switchgear must be observed.                                   |
| 10.12 Electromagnetic compatibility  |            |    | Is the panel builder's responsibility. The specifications for the switchgear must be observed.                                   |
| 10.13 Mechanical function  |            |    | The device meets the requirements, provided the information in the instruction leaflet (IL) is observed.                         |

## Technical data ETIM 7.0

| Low-voltage industrial components (EG000017) / Power contactor, AC switching (EC000066)   |    |  |           |
|---|----|--|-----------|
| Electric engineering, automation, process control engineering / Low-voltage switch technology / Contactor (LV) / Power contactor, AC switching (ecl@ss10.0.1-27-37-10-03 [AAB718015]) |    |  |           |
| Rated control supply voltage $U_s$ at AC 50HZ   | V  |  | 380 - 380 |
| Rated control supply voltage $U_s$ at AC 60HZ   | V  |  | 380 - 380 |
| Rated control supply voltage $U_s$ at DC  | V  |  | 0 - 0     |
| Voltage type for actuating  |    |  | AC        |
| Rated operation current $I_e$ at AC-1, 400 V  | A  |  | 22        |
| Rated operation current $I_e$ at AC-3, 400 V  | A  |  | 9         |
| Rated operation power at AC-3, 400 V  | kW |  | 4         |
| Rated operation current $I_e$ at AC-4, 400 V  | A  |  | 6.6       |
| Rated operation power at AC-4, 400 V  | kW |  | 3         |
| Rated operation power NEMA  | kW |  | 3.7       |
| Modular version   |    |  | No        |
| Number of auxiliary contacts as normally open contact   |    |  | 1         |

|   |  |                  |
|---|--|------------------|
| Number of auxiliary contacts as normally closed contact |  | 0                |
| Type of electrical connection of main circuit           |  | Screw connection |
| Number of normally closed contacts as main contact      |  | 0                |
| Number of main contacts as normally open contact        |  | 3                |

## Approvals

|                                      |  |   |
|--------------------------------------|--|---|
| Product Standards                    |  | IEC/EN 60947-4-1; UL 508; CSA-C22.2 No. 14-05; CE marking |
| UL File No.                          |  | E29096  |
| UL Category Control No.              |  | NLDX  |
| CSA File No.                         |  | 012528  |
| CSA Class No.                        |  | 3211-04   |
| North America Certification          |  | UL listed, CSA certified                                  |
| Specially designed for North America |  | No  |



- 1: Overload relay
  - 2: Suppressor
  - 3: Auxiliary contact modules
- Enclosure totally insulated





Normal AC induction motor  
 Operating characteristics  
 Switch on: from stop  
 Switch off: during run  
 Electrical characteristics:  
 Switch on: up to 6 x Rated motor current  
 Switch off: up to 1 x Rated motor current  
 Utility category  
 100 % AC-3  
 Typical Applications  
 Compressors  
 Lifts  
 Mixers  
 Pumps  
 Escalators  
 Agitators  
 fan  
 Conveyor belts  
 Centrifuges  
 Hinged flaps  
 Bucket-elevator  
 Air-conditioning systems  
 General drives for manufacturing and processing machines



- Extreme switching duty
- Squirrel-cage motor
- Operating characteristics
- Inching, plugging, reversing
- Electrical characteristics
- Make: up to 6 x rated motor current
- Break: up to 6 x rated motor current
- Utilization category
- 100 % AC-4
- Typical applications
- Printing presses
- Wire-drawing machines
- Centrifuges
- Special drives for manufacturing and processing machines



Switching duty for non-motor loads, 3-pole, 4-pole  
 Operating characteristics  
 Non-inductive or slightly inductive loads  
 Electrical characteristics  
 Make: 1 x rated current  
 Break: 1 x rated current  
 Utilization category  
 100 % AC-1  
 Typical applications  
 Electric heat

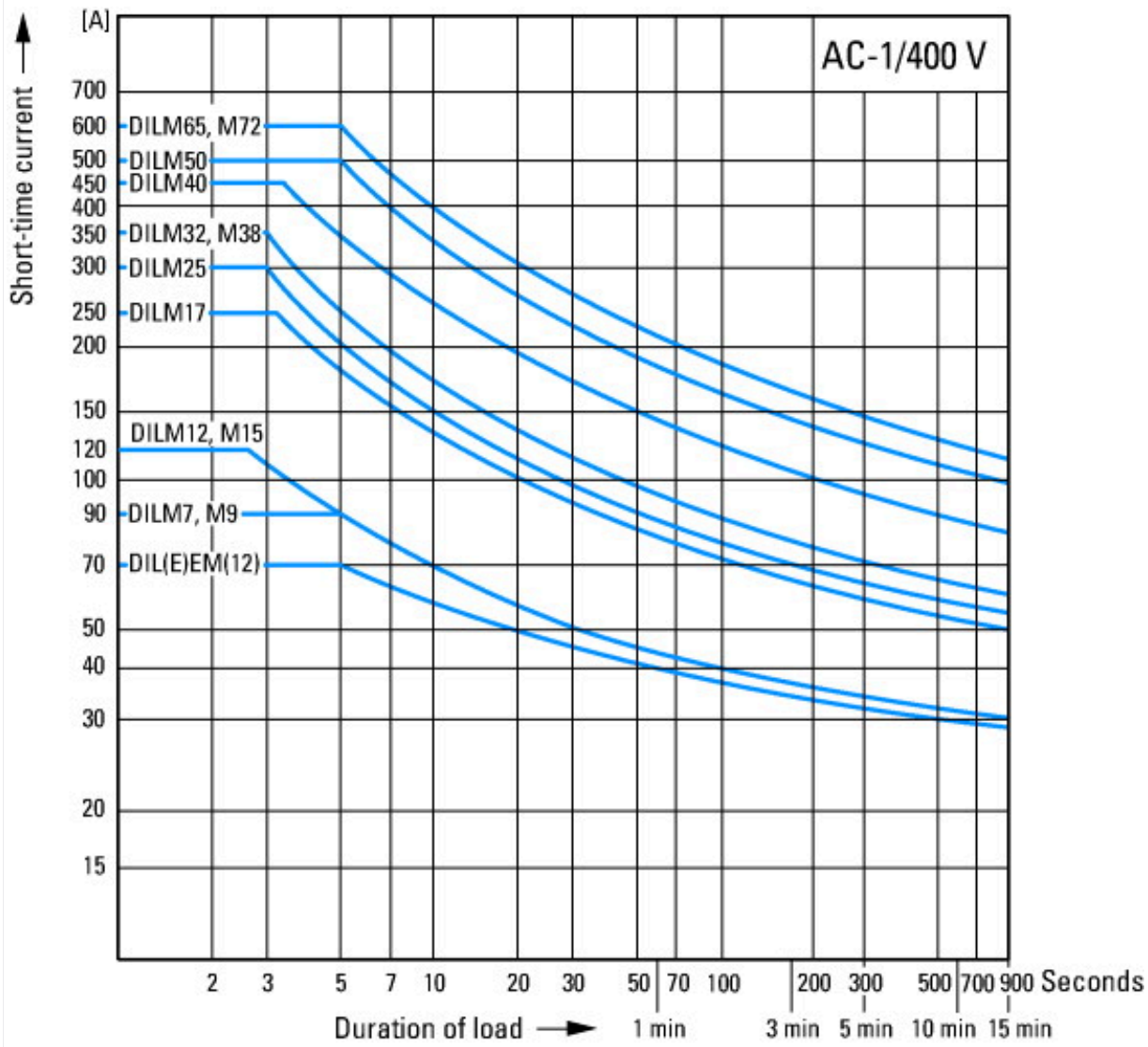

Short-time loading, 3-pole  
 Time interval between two loading cycles: 15 minutes

### Dimensions

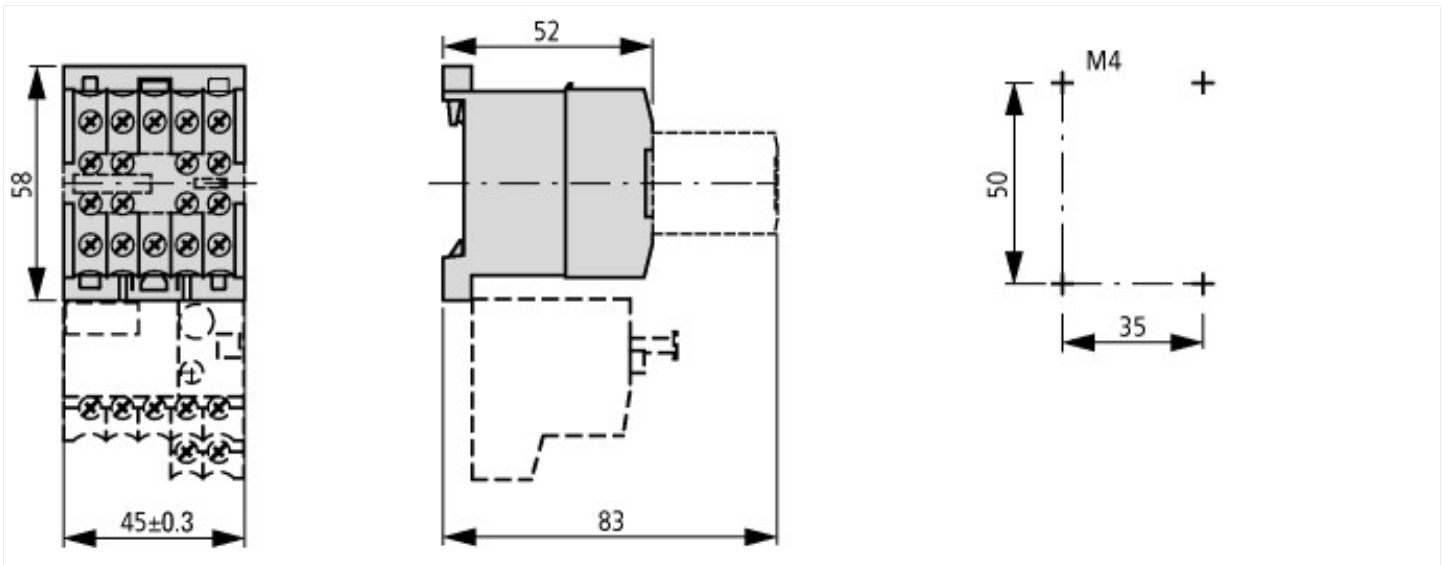

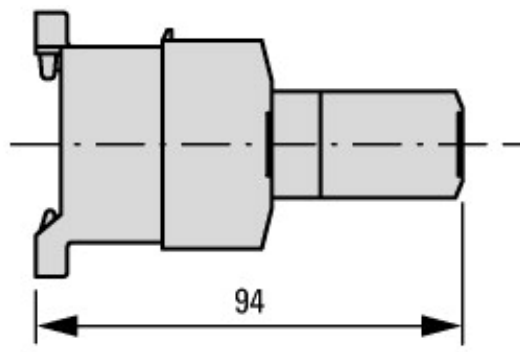
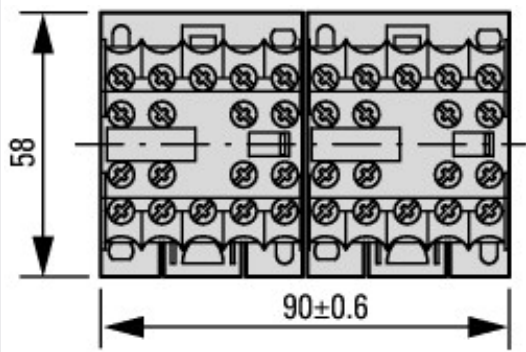

2DILE-... + MVDILE + ...DILE  
2DILE-...-G + MVDILE + ...DILE

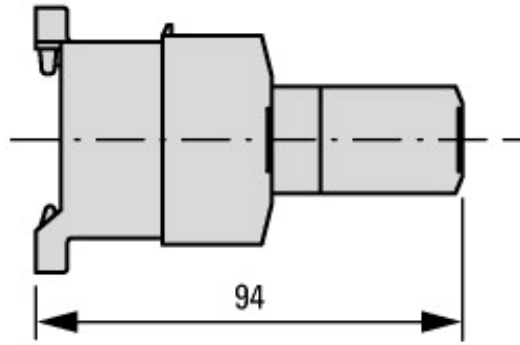
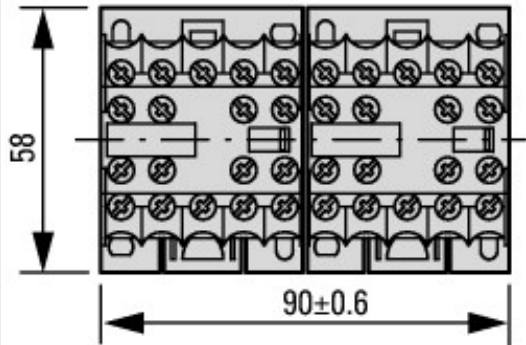

2DILE-... + MVDILE + ...DILE  
2DILE-...-G + MVDILE + ...DILE

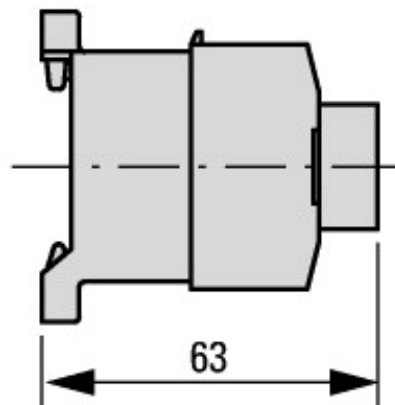
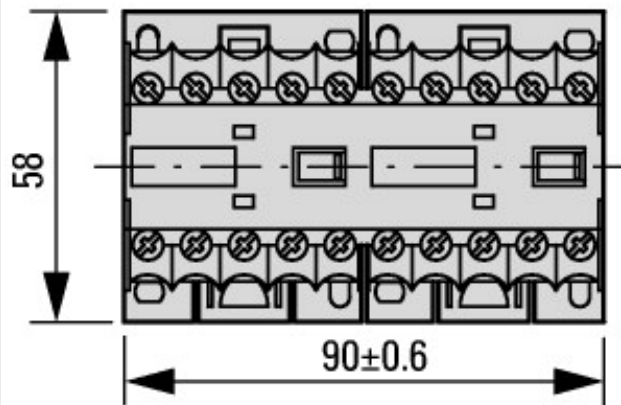

2DILE-... + MVDILE  
2DILE-...-G + MVDILE

## Additional product information (links)

**IL03407009Z (AWA2100-0882) mini contactor relay**

IL03407009Z (AWA2100-0882) mini contactor relay

[https://es-assets.eaton.com/DOCUMENTATION/AWA\\_INSTRUCTIONS/IL03407009Z2020\\_05.pdf](https://es-assets.eaton.com/DOCUMENTATION/AWA_INSTRUCTIONS/IL03407009Z2020_05.pdf)