



Changeoverswitches, T3, 32 A, rear mounting, 2 contact unit(s), Contacts: 4, 45 °, momentary, Without 0 (Off) position, With spring-return to 1, 1<2, Design number 8296

Part no. T3-2-8296/Z
Catalog No. 018476



Similar to illustration

Delivery program

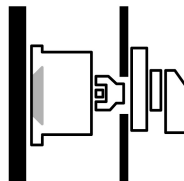
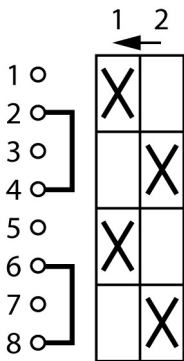
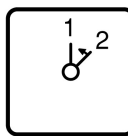
Product range			Control switches
Part group reference			T3
Basic function			Changeoverswitches with black thumb grip and front plate
Contacts			4
Degree of Protection			Front IP65
Design			rear mounting
			
Contact sequence			
Switching angle		°	45
Switching performance			momentary Without 0 (Off) position With spring-return to 1
Design number			8296
Front plate no.			 FS 496
front plate			1<2
Motor rating AC-23A, 50 - 60 Hz			
400 V	P	kW	15
Rated uninterrupted current	I _u	A	32
Note on rated uninterrupted current I _u			Rated uninterrupted current I _u is specified for max. cross-section.
Number of contact units		contact unit(s)	2

Technical data

Standards		IEC/EN 60947, VDE 0660, IEC/EN 60204, CSA, UL
-----------	--	---

Climatic proofing			Switch-disconnector according to IEC/EN 60947-3 Damp heat, constant, to IEC 60068-2-78 Damp heat, cyclic, to IEC 60068-2-30
Ambient temperature			
Open		°C	-25 - +50
Enclosed		°C	-25 - +40
Overvoltage category/pollution degree			III/3
Rated impulse withstand voltage	U_{imp}	V AC	6000
Mechanical shock resistance		g	15
Mounting position			As required

Contacts

Electrical characteristics			
Rated operational voltage	U_e	V AC	690
Rated uninterrupted current	I_u	A	32
Note on rated uninterrupted current I_u			Rated uninterrupted current I_u is specified for max. cross-section.
Load rating with intermittent operation, class 12			
AB 25 % DF		$\times I_e$	2
AB 40 % DF		$\times I_e$	1.6
AB 60 % DF		$\times I_e$	1.3
Short-circuit rating			
Fuse		A gG/gL	35
Rated short-time withstand current (1 s current)	I_{cw}	A_{rms}	650
Note on rated short-time withstand current I_{cw}			Current for a time of 1 second
Rated conditional short-circuit current	I_q	kA	1

Switching capacity

cos φ rated making capacity as per IEC 60947-3		A	320
Rated breaking capacity cos φ to IEC 60947-3		A	
230 V		A	260
400/415 V		A	260
500 V		A	240
690 V		A	170
Safe isolation to EN 61140			
between the contacts		V AC	440
Current heat loss per contact at I_e		W	1.1
Current heat loss per auxiliary circuit at I_e (AC-15/230 V)		CO	1.1
Lifespan, mechanical	Operations	$\times 10^6$	> 0.5
Maximum operating frequency	Operations/h		1200
AC			
AC-3			
Rating, motor load switch	P	kW	
220 V 230 V	P	kW	5.5
230 V Star-delta	P	kW	7.5
400 V 415 V	P	kW	11
400 V Star-delta	P	kW	15
500 V	P	kW	15
500 V Star-delta	P	kW	18.5
690 V	P	kW	11
690 V Star-delta	P	kW	22
Rated operational current motor load switch			
230 V	I_e	A	23.7
230 V star-delta	I_e	A	32
400V 415 V	I_e	A	23.7
400 V star-delta	I_e	A	32
500 V	I_e	A	23.7
500 V star-delta	I_e	A	32

690 V	I _e	A	14.7
690 V star-delta	I _e	A	25.5
AC-21A			
Rated operational current switch			
440 V	I _e	A	32
AC-23A			
Motor rating AC-23A, 50 - 60 Hz			
230 V	P	kW	7.5
400 V 415 V	P	kW	15
500 V	P	kW	15
690 V	P	kW	15
Rated operational current motor load switch			
230 V	I _e	A	32
400 V 415 V	I _e	A	32
500 V	I _e	A	26.4
690 V	I _e	A	17
DC			
DC-1, Load-break switches L/R = 1 ms			
Rated operational current	I _e	A	25
Voltage per contact pair in series		V	60
DC-21A			
Rated operational current	I _e	A	1
Contacts		Quantity	1
DC-23A, motor load switch L/R = 15 ms			
24 V			
Rated operational current	I _e	A	25
Contacts		Quantity	1
48 V			
Rated operational current	I _e	A	25
Contacts		Quantity	2
60 V			
Rated operational current	I _e	A	25
Contacts		Quantity	3
120 V			
Rated operational current	I _e	A	12
Contacts		Quantity	3
240 V			
Rated operational current	I _e	A	5
Contacts		Quantity	5
DC-13, Control switches L/R = 50 ms			
Rated operational current	I _e	A	20
Voltage per contact pair in series		V	24
Control circuit reliability at 24 V DC, 10 mA	Fault probability	H _F	< 10 ⁻⁵ , < 1 failure in 100,000 switching operations

Terminal capacities

Solid or stranded		mm ²	1 x (1 - 6) 2 x (1 - 6)
Flexible with ferrules to DIN 46228		mm ²	1 x (0.75 - 4) 2 x (0.75 - 4)
Terminal screw			M4
Tightening torque for terminal screw		Nm	1.6

Technical safety parameters:

Notes			B10 _d values as per EN ISO 13849-1, table C1
--------------	--	--	---

Rating data for approved types

Contacts			
Rated operational voltage	U _e	V AC	600

Rated uninterrupted current max.			
Main conducting paths			
General use		A	25
Auxiliary contacts			
General Use	I _U	A	10
Pilot Duty			A 600
Switching capacity			
Maximum motor rating			
Single-phase			
120 V AC		HP	1.5
200 V AC		HP	3
240 V AC		HP	3
Three-phase			
200 V AC		HP	3
240 V AC		HP	3
480 V AC		HP	7.5
600 V AC		HP	10
Short Circuit Current Rating		SCCR	
Basic Rating		kA	5
max. Fuse		A	40
High fault rating		kA	10
max. Fuse		A	40, Class J
Terminal capacity			
Solid or flexible conductor with ferrule		AWG	14 - 10
Terminal screw			M4
Tightening torque		lb-in	17.7

Design verification as per IEC/EN 61439

Technical data for design verification			
Rated operational current for specified heat dissipation	I _n	A	32
Heat dissipation per pole, current-dependent	P _{vid}	W	1.1
Equipment heat dissipation, current-dependent	P _{vid}	W	0
Static heat dissipation, non-current-dependent	P _{vs}	W	0
Heat dissipation capacity	P _{diss}	W	0
Operating ambient temperature min.		°C	-25
Operating ambient temperature max.		°C	50
IEC/EN 61439 design verification			
10.2 Strength of materials and parts			
10.2.2 Corrosion resistance			
10.2.2.1 Verification of thermal stability of enclosures			Meets the product standard's requirements.
10.2.2.2 Verification of resistance of insulating materials to normal heat			Meets the product standard's requirements.
10.2.2.3 Verification of resistance of insulating materials to abnormal heat and fire due to internal electric effects			Meets the product standard's requirements.
10.2.4 Resistance to ultra-violet (UV) radiation			UV resistance only in connection with protective shield.
10.2.5 Lifting			Does not apply, since the entire switchgear needs to be evaluated.
10.2.6 Mechanical impact			Does not apply, since the entire switchgear needs to be evaluated.
10.2.7 Inscriptions			Meets the product standard's requirements.
10.3 Degree of protection of ASSEMBLIES			Does not apply, since the entire switchgear needs to be evaluated.
10.4 Clearances and creepage distances			Meets the product standard's requirements.
10.5 Protection against electric shock			Does not apply, since the entire switchgear needs to be evaluated.
10.6 Incorporation of switching devices and components			Does not apply, since the entire switchgear needs to be evaluated.
10.7 Internal electrical circuits and connections			Is the panel builder's responsibility.
10.8 Connections for external conductors			Is the panel builder's responsibility.
10.9 Insulation properties			
10.9.2 Power-frequency electric strength			Is the panel builder's responsibility.

10.9.3 Impulse withstand voltage		Is the panel builder's responsibility.
10.9.4 Testing of enclosures made of insulating material		Is the panel builder's responsibility.
10.10 Temperature rise		The panel builder is responsible for the temperature rise calculation. Eaton will provide heat dissipation data for the devices.
10.11 Short-circuit rating		Is the panel builder's responsibility. The specifications for the switchgear must be observed.
10.12 Electromagnetic compatibility		Is the panel builder's responsibility. The specifications for the switchgear must be observed.
10.13 Mechanical function		The device meets the requirements, provided the information in the instruction leaflet (IL) is observed.

Technical data ETIM 7.0

Low-voltage industrial components (EG000017) / Control switch (EC002611)		
Electric engineering, automation, process control engineering / Low-voltage switch technology / Off-load switch, circuit breaker, control switch / Control switch (ecl@ss10.0.1-27-37-14-14 [ACN998011])		
Type of switch		Reverser
Number of poles		2
Max. rated operation voltage Ue AC	V	690
Rated permanent current Iu	A	32
Number of switch positions		2
With 0 (off) position		No
With retraction in 0-position		No
Device construction		Built-in device
Width in number of modular spacings		0
Suitable for ground mounting		Yes
Suitable for front mounting 4-hole		No
Suitable for distribution board installation		No
Suitable for intermediate mounting		Yes
Complete device in housing		No
Type of control element		Toggle
Front shield size		48x48 mm
Degree of protection (IP), front side		IP65
Degree of protection (NEMA), front side		12

Approvals

Product Standards		UL 60947-4-1; CSA - C22.2 No. 60947-4-1-14; CSA-C22.2 No. 94; IEC/EN 60947-3; CE marking
UL File No.		E36332
UL Category Control No.		NLRV
CSA File No.		12528
CSA Class No.		3211-05
North America Certification		UL listed, CSA certified
Suitable for		Branch circuits, suitable as motor disconnect
Degree of Protection		IEC: IP65; UL/CSA Type 1, 12

Dimensions

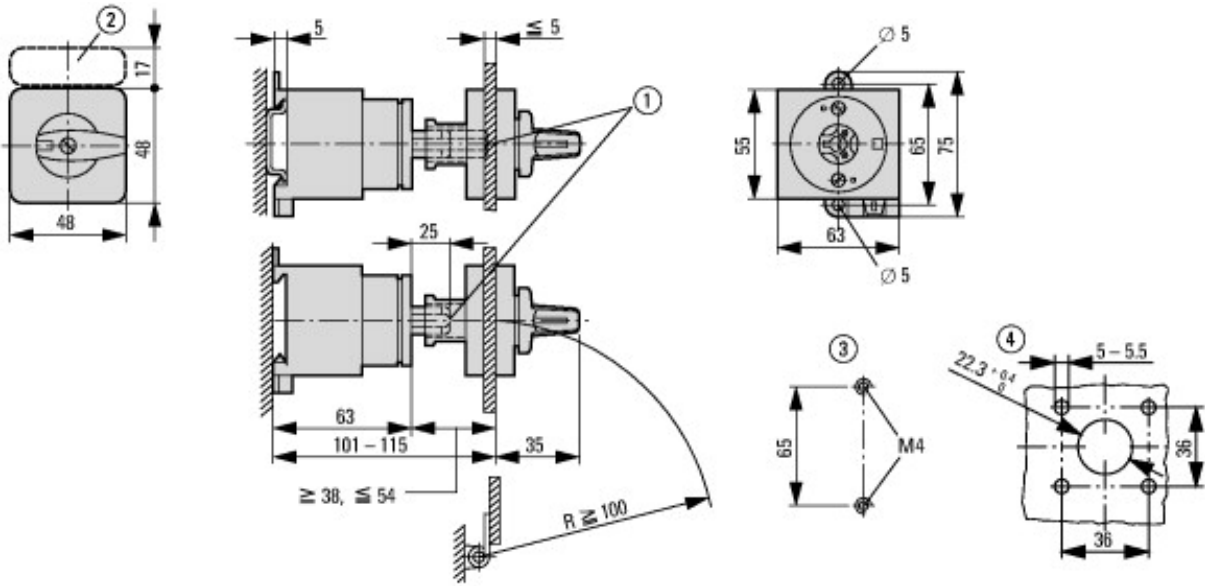

- ① Shaft extension with ZAV-T0 possible, max. $4 \times 25 = 100$ mm
- ② ZFS-... Label mount not included as standard
- ③ Drilling dimensions base
- ④ Drilling dimensions door

Assets (links)

Declaration of CE Conformity

00003074

Instruction Leaflets

IL03801021Z2018_05

Additional product information (links)

IL03801021Z (AWA1150-0587) Cam switches: rear mounting

IL03801021Z (AWA1150-0587) Cam switches: rear mounting	ftp://ftp.moeller.net/DOCUMENTATION/AWA_INSTRUCTIONS/IL03801021Z2018_05.pdf
Display flip catalog page.	http://ecat.moeller.net/flip-cat/?edition=K115A&startpage=102
Technical overview cam switch, switch-disconnector	http://de.ecat.moeller.net/flip-cat/?edition=HPLTEv1&startpage=4.2
System overview cam switch T	http://de.ecat.moeller.net/flip-cat/?edition=HPLTEv1&startpage=4.4
System overview switch-disconnector P	http://de.ecat.moeller.net/flip-cat/?edition=HPLTEv1&startpage=4.6
Key to part numbers Cam switch	http://de.ecat.moeller.net/flip-cat/?edition=HPLTEv1&startpage=4.8
Key to part numbers Switch-disconnector	http://de.ecat.moeller.net/flip-cat/?edition=HPLTEv1&startpage=4.8
Switches for ATEX	http://www.coopercrouse-hinds.eu/en/products/25-ex-safety-and-main-current-switches.html
Ordering form for SOND switches and SOND front plates(DE_EN)	ftp://ftp.moeller.net/DOCUMENTATION/PDF/MZ008005ZU_Orderform_Customized_Switch.pdf
Ordering form for SOND switches and SOND front plates(DE_EN)	ftp://ftp.moeller.net/DOCUMENTATION/PDF/MZ008006ZU_Orderform_Customized_Switch.pdf