



Motor-Protective Circuit-Breakers, 3-pole, $I_r = 0.63 - 1$ A, screw/spring clamp connection, rotary handle lockable

Part no. PKZM0-1-SC/AK
Catalog No. 265349
Alternate Catalog No. XTPRSC001BC1

Delivery program

| | | | | |
|--|----------|-------|---|--|
| Product range | | | | PKZM0 motor protective circuit-breakers up to 32 A |
| Basic function | | | | Motor protection |
| | | | | |
| Notes | | | | Also suitable for motors with efficiency class IE3. IE3-ready devices are identified by the logo on their packaging. |
| Connection technique | | | | Screw terminals on feed side/spring-cage terminals on output side |
| Contact sequence | | | | |
| Max. motor rating | | | | |
| AC-3 | | | | |
| 220 V 230 V 240 V | P | kW | | 0.12 |
| 380 V 400 V 415 V | P | kW | | 0.25 |
| 440 V | P | kW | | 0.25 |
| 500 V | P | kW | | 0.37 |
| 660 V 690 V | P | kW | | 0.55 |
| Rated uninterrupted current | I_u | A | | 1 |
| Setting range | | | | |
| Overload releases | | I_r | A | 0.63 - 1 |
| short-circuit release | | | | |
| max. | I_{rm} | A | | 15.5 |
| Phase-failure sensitivity | | | | IEC/EN 60947-4-1, VDE 0660 Part 102 |
| Explosion protection (according to ATEX 94/9/EC) | | | | PTB 10, ATEX 3013, Ex II(2) GD Observe manual MN03402003Z-DE/EN. |
| Notes Overload trigger: tripping class 10 A Can be snapped on to IEC/EN 60715 top-hat rail with 7.5 or 15 mm height. | | | | |

Technical data

| | | | | |
|---------------------|--|----|--|--|
| General | | | | |
| Standards | | | | IEC/EN 60947, VDE 0660, UL, CSA |
| Climatic proofing | | | | Damp heat, constant, to IEC 60068-2-78 Damp heat, cyclic, to IEC 60068-2-30 |
| Ambient temperature | | | | |
| Storage | | °C | | - 40 - 80 |
| Open | | °C | | -25 - +55 |
| Enclosed | | °C | | - 25 - 40 |

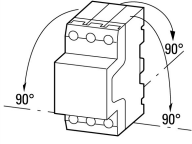
| | | | |
|---|--|-----------------|---|
| Mounting position | | |  |
| Direction of incoming supply | | | as required |
| Degree of protection | | | |
| Device | | | IP20 |
| Terminations | | | IP00 |
| Protection against direct contact when actuated from front (EN 50274) | | | Finger and back-of-hand proof |
| Mechanical shock resistance half-sinusoidal shock 10 ms to IEC 60068-2-27 | | g | 25 |
| Altitude | | m | Max. 2000 |
| Terminal capacity main cable | | | |
| Screw terminals | | | |
| Solid | | mm ² | 1 x (1 - 6) 2 x (1 - 6) |
| Flexible with ferrule to DIN 46228 | | mm ² | 1 x (1 - 6) 2 x (1 - 6) |
| Solid or stranded | | AWG | 18 - 10 |
| Stripping length | | mm | 10 |
| Spring-loaded terminals | | | |
| Solid | | mm ² | 1 x (0.75...2.5) 2 x (0.75...2.5) |
| Flexible with ferrule to DIN 46228 | | mm ² | 1 x (0.75...2.5) 2 x (0.75...2.5) |
| Flexible without ferrule | | mm ² | 1 x (0.75...2.5) 2 x (0.75...2.5) |
| Solid or stranded | | AWG | 18...14 |
| Specified tightening torque for terminal screws | | | |
| Main cable | | Nm | 1.7 |

Main conducting paths

| | | | |
|---|-------------|---------------|--------------------------|
| Rated impulse withstand voltage | U_{imp} | V AC | 6000 |
| Overvoltage category/pollution degree | | | III/3 |
| Rated operational voltage | U_e | V AC | 690 |
| Rated uninterrupted current = rated operational current | $I_u = I_e$ | A | 1 |
| Rated frequency | f | Hz | 40 - 60 |
| Current heat loss (3 pole at operating temperature) | | W | 5.33 |
| Impedance per pole | | mΩ | 1700 |
| Lifespan, mechanical | Operations | $\times 10^6$ | 0.1 |
| Lifespan, electrical (AC-3 at 400 V) | | | |
| Lifespan, electrical | Operations | $\times 10^6$ | 0.1 |
| Max. operating frequency | | Ops/h | 40 |
| Short-circuit rating | | | |
| DC | | | |
| Short-circuit rating | | kA | 60 |
| Notes | | | up to 250 V |
| Motor switching capacity | | | |
| AC-3 (up to 690V) | | A | 1 |
| DC-5 (up to 250V) | | A | 1 (3 contacts in series) |

Trip blocks

| | | | |
|---|--|--------------|--|
| Temperature compensation | | | |
| to IEC/EN 60947, VDE 0660 | | °C | - 5 ... 40 |
| Operating range | | °C | - 25 ... 55 |
| Temperature compensation residual error for $T > 40$ °C | | | ≤ 0.25 %/K |
| Setting range of overload releases | | $\times I_u$ | 0.6 - 1 |
| short-circuit release | | | Basic device, fixed: $15.5 \times I_u$ |
| Short-circuit release tolerance | | | ± 20 % |
| Phase-failure sensitivity | | | IEC/EN 60947-4-1, VDE 0660 Part 102 |

Design verification as per IEC/EN 61439

| Technical data for design verification | | | |
|--|------------|----|--|
| Rated operational current for specified heat dissipation | I_n | A | 1 |
| Heat dissipation per pole, current-dependent | P_{vid} | W | 1.78 |
| Equipment heat dissipation, current-dependent | P_{vid} | W | 5.33 |
| Static heat dissipation, non-current-dependent | P_{vs} | W | 0 |
| Heat dissipation capacity | P_{diss} | W | 0 |
| Operating ambient temperature min. | | °C | -25 |
| Operating ambient temperature max. | | °C | 55 |
| IEC/EN 61439 design verification | | | |
| 10.2 Strength of materials and parts | | | |
| 10.2.2 Corrosion resistance | | | |
| | | | Meets the product standard's requirements. |
| 10.2.3.1 Verification of thermal stability of enclosures | | | |
| | | | Meets the product standard's requirements. |
| 10.2.3.2 Verification of resistance of insulating materials to normal heat | | | |
| | | | Meets the product standard's requirements. |
| 10.2.3.3 Verification of resistance of insulating materials to abnormal heat and fire due to internal electric effects | | | |
| | | | Meets the product standard's requirements. |
| 10.2.4 Resistance to ultra-violet (UV) radiation | | | |
| | | | Meets the product standard's requirements. |
| 10.2.5 Lifting | | | |
| | | | Does not apply, since the entire switchgear needs to be evaluated. |
| 10.2.6 Mechanical impact | | | |
| | | | Does not apply, since the entire switchgear needs to be evaluated. |
| 10.2.7 Inscriptions | | | |
| | | | Meets the product standard's requirements. |
| 10.3 Degree of protection of ASSEMBLIES | | | |
| | | | Does not apply, since the entire switchgear needs to be evaluated. |
| 10.4 Clearances and creepage distances | | | |
| | | | Meets the product standard's requirements. |
| 10.5 Protection against electric shock | | | |
| | | | Does not apply, since the entire switchgear needs to be evaluated. |
| 10.6 Incorporation of switching devices and components | | | |
| | | | Does not apply, since the entire switchgear needs to be evaluated. |
| 10.7 Internal electrical circuits and connections | | | |
| | | | Is the panel builder's responsibility. |
| 10.8 Connections for external conductors | | | |
| | | | Is the panel builder's responsibility. |
| 10.9 Insulation properties | | | |
| 10.9.2 Power-frequency electric strength | | | |
| | | | Is the panel builder's responsibility. |
| 10.9.3 Impulse withstand voltage | | | |
| | | | Is the panel builder's responsibility. |
| 10.9.4 Testing of enclosures made of insulating material | | | |
| | | | Is the panel builder's responsibility. |
| 10.10 Temperature rise | | | |
| | | | The panel builder is responsible for the temperature rise calculation. Eaton will provide heat dissipation data for the devices. |
| 10.11 Short-circuit rating | | | |
| | | | Is the panel builder's responsibility. The specifications for the switchgear must be observed. |
| 10.12 Electromagnetic compatibility | | | |
| | | | Is the panel builder's responsibility. The specifications for the switchgear must be observed. |
| 10.13 Mechanical function | | | |
| | | | The device meets the requirements, provided the information in the instruction leaflet (IL) is observed. |

Technical data ETIM 7.0

| Low-voltage industrial components (EG000017) / Motor protection circuit-breaker (EC000074) | | | |
|---|--|----|--|
| Electric engineering, automation, process control engineering / Low-voltage switch technology / Circuit breaker (LV < 1 kV) / Motor protection circuit-breaker (ecl@ss10.0.1-27-37-04-01 [AGZ529016]) | | | |
| Overload release current setting | | A | 0.63 - 1 |
| Adjustment range undelayed short-circuit release | | A | 15.5 - 15.5 |
| With thermal protection | | | Yes |
| Phase failure sensitive | | | Yes |
| Switch off technique | | | Thermomagnetic |
| Rated operating voltage | | V | 690 - 690 |
| Rated permanent current I_u | | A | 1 |
| Rated operation power at AC-3, 230 V | | kW | 0.12 |
| Rated operation power at AC-3, 400 V | | kW | 0.25 |
| Type of electrical connection of main circuit | | | Other |
| Type of control element | | | Turn button |
| Device construction | | | Built-in device fixed built-in technique |
| With integrated auxiliary switch | | | No |
| With integrated under voltage release | | | No |

| | | |
|--|----|------|
| Number of poles | | 3 |
| Rated short-circuit breaking capacity Icu at 400 V, AC | kA | 150 |
| Degree of protection (IP) | | IP20 |
| Height | mm | 93 |
| Width | mm | 45 |
| Depth | mm | 94 |

Approvals

| | | |
|--------------------------------------|--|--|
| Product Standards | | IEC/EN 60947-4-1; UL 60947-4-1; CSA - C22.2 No. 60947-4-1-14; CE marking |
| UL File No. | | E36332 |
| UL Category Control No. | | NLRV |
| CSA File No. | | 165628 |
| CSA Class No. | | 3211-05 |
| North America Certification | | UL listed, CSA certified |
| Specially designed for North America | | No |

Characteristics

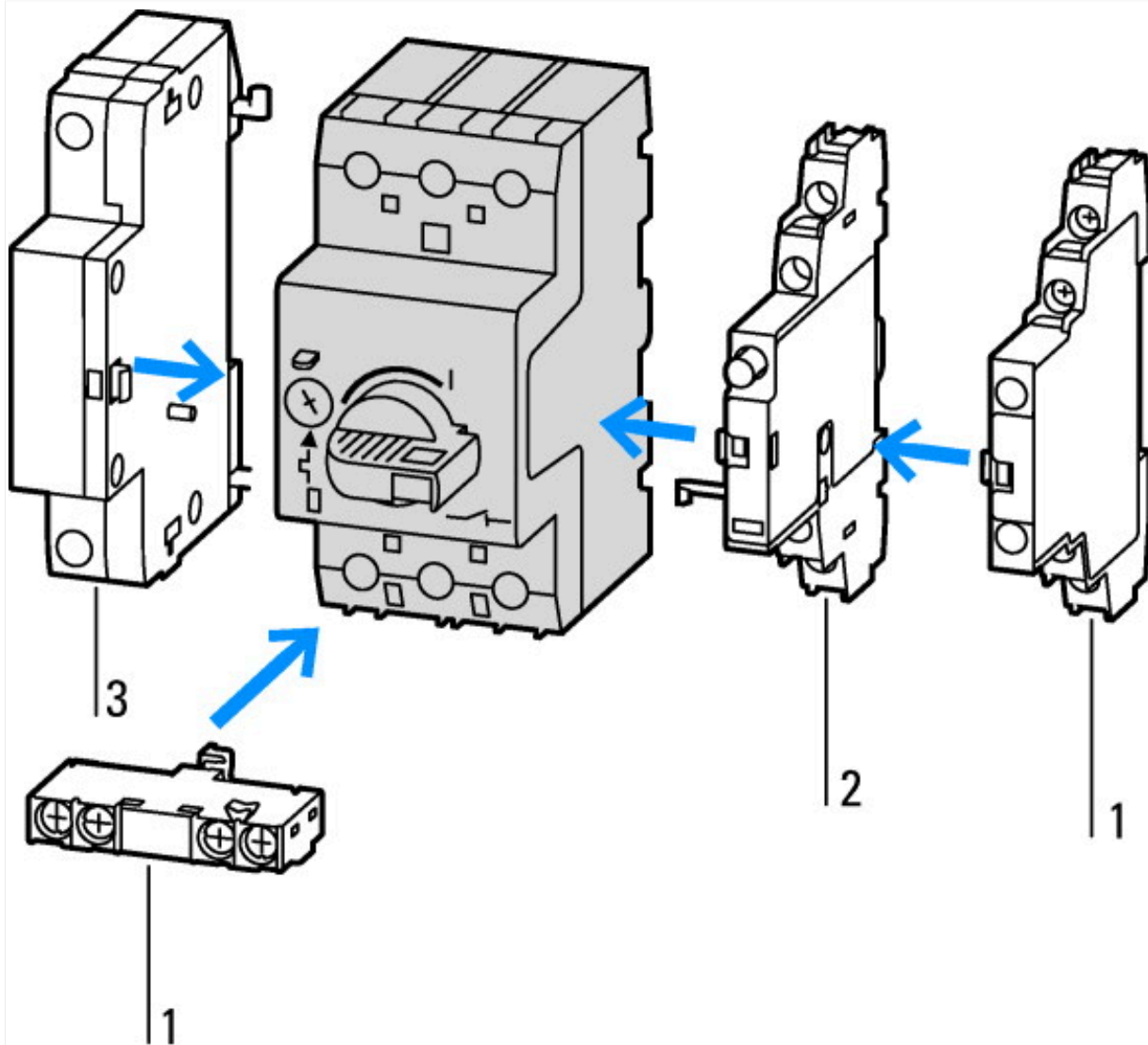

- 1: Standard auxiliary contact
- 2: Trip-indicating auxiliary contact
- 3: Shunt releases, undervoltage releases

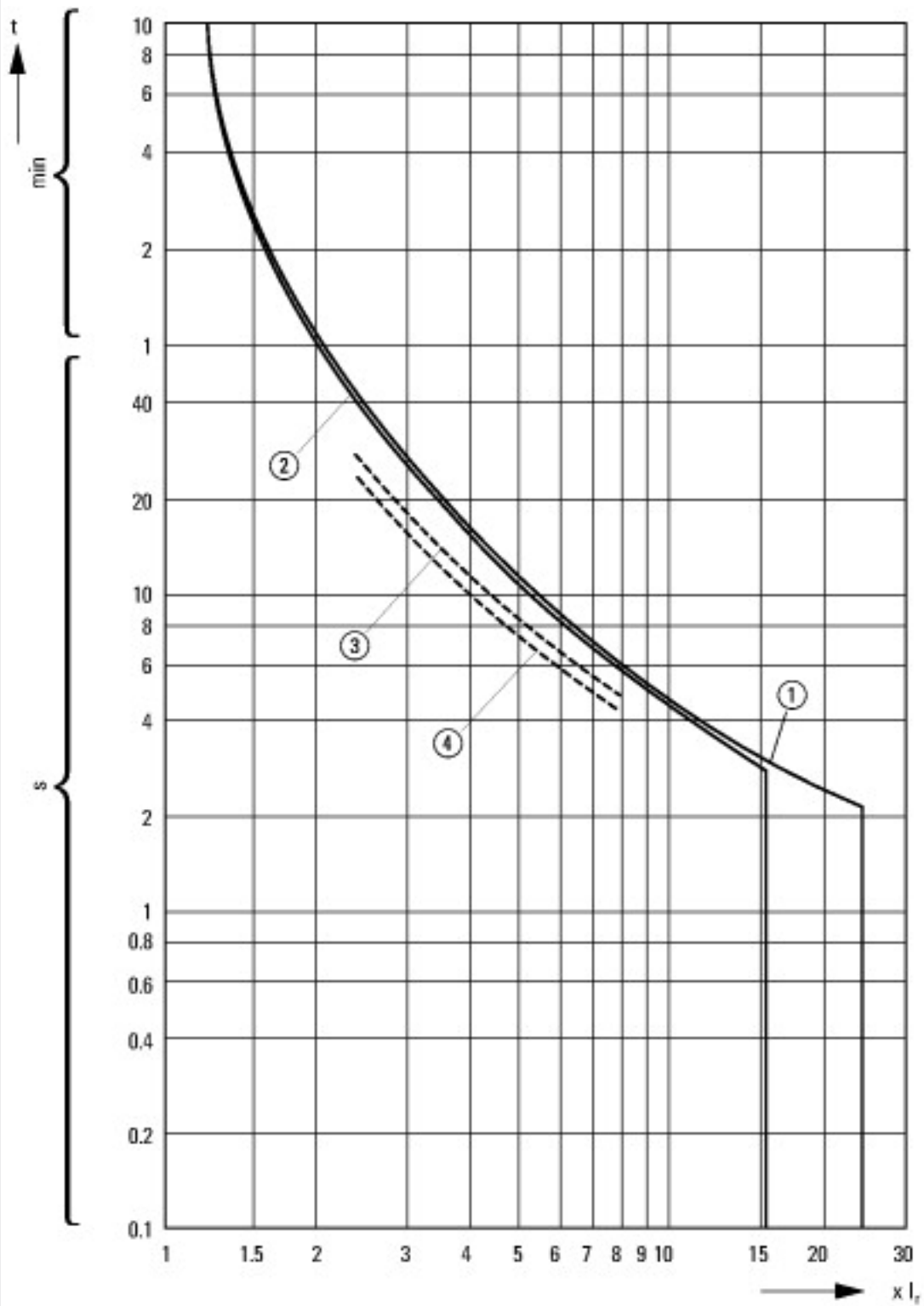

Tripping characteristics motor circuit breaker PKZM0-..., PKZM01

- 1: Minimum level, 3-phase
- 2: Maximum level, 3-phase
- 3: Minimum marker, 2-phase
- 4: Highest marker, 2-phase

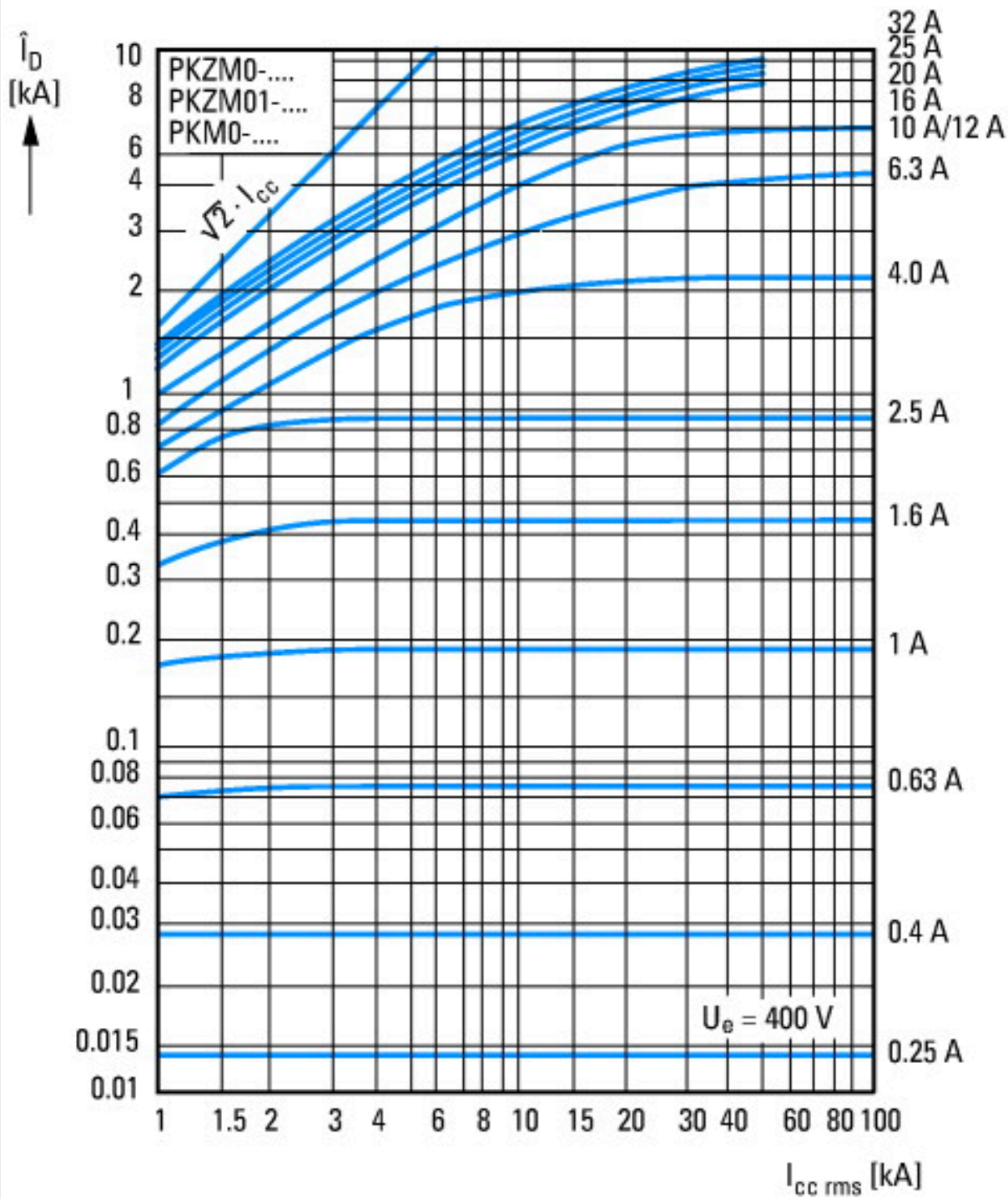

Let-through current

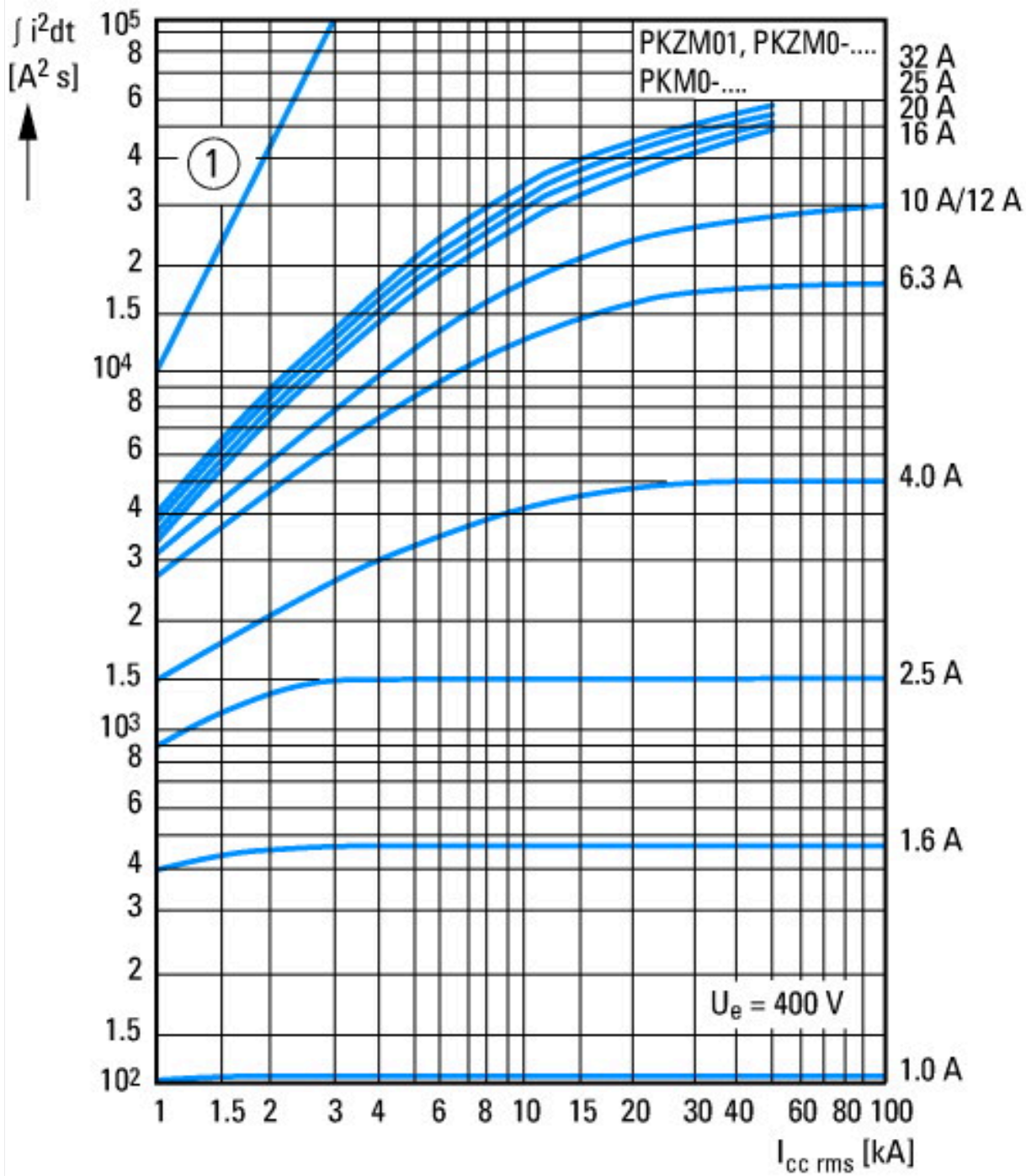

① 1 half-cycle
 Let-through energy

Dimensions

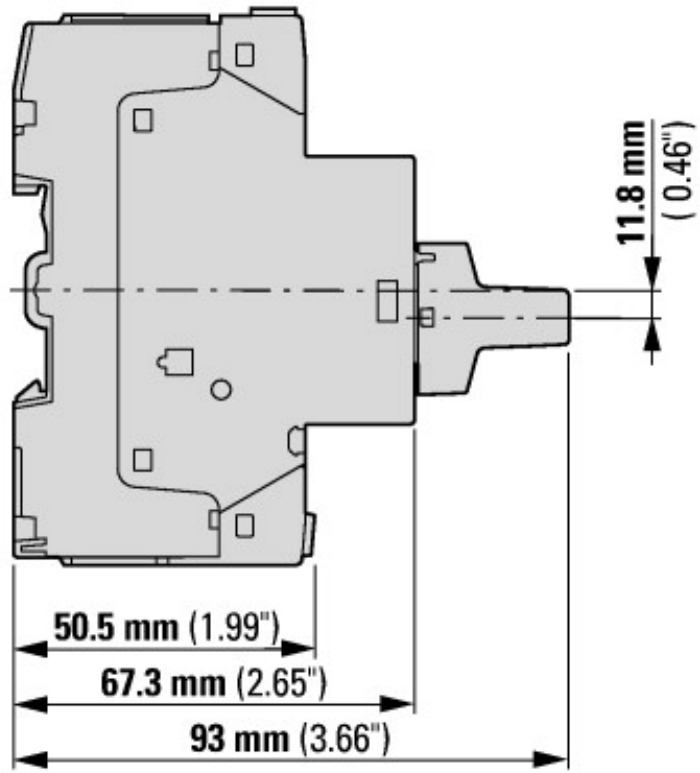
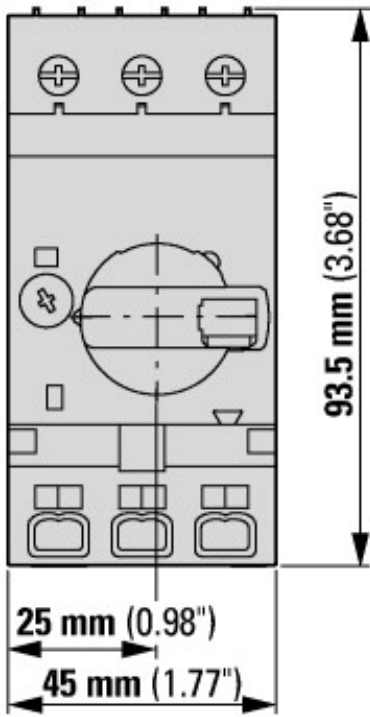

Motor-protective circuit-breaker with standard auxiliary contact
 PKZM0-...(+NHI-E-...-PKZ0)
 PKZM0-...-T(+NHI-E-...-PKZ0)
 PKM0-...(+NHI-E-...-PKZ0)

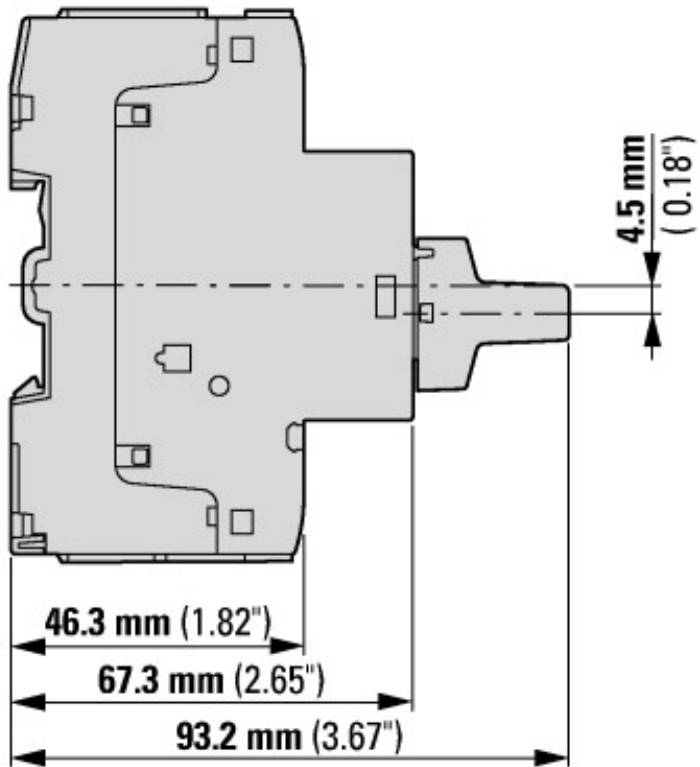
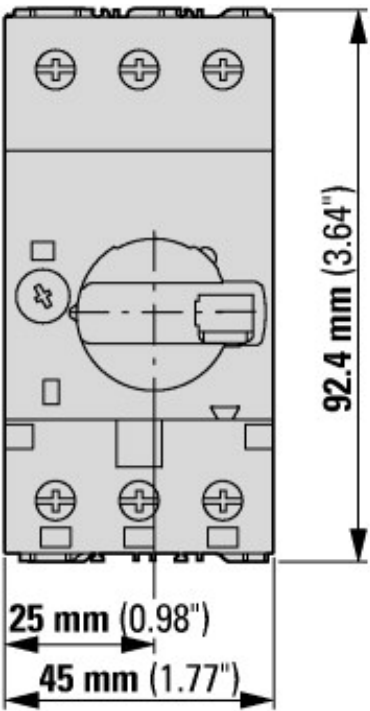

Motor-protective circuit-breakers with lockable rotary handles
 PKZM0-...+AK-PKZ0

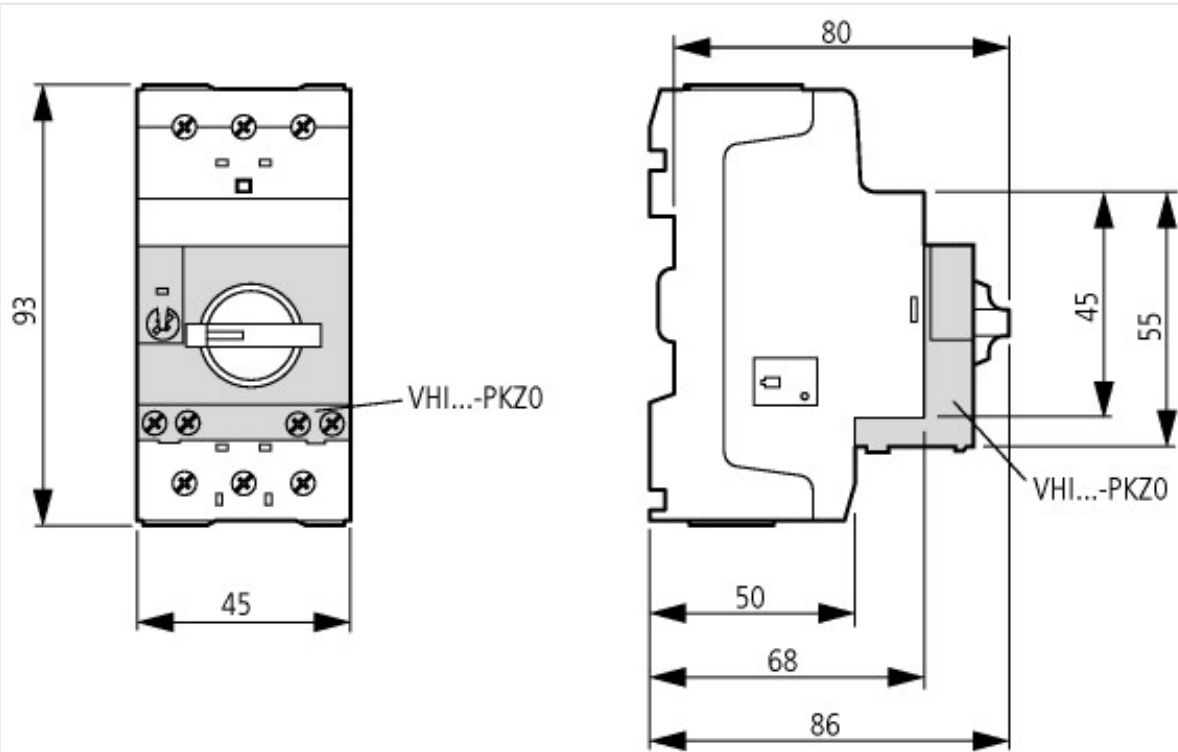

Motor-protective circuit-breakers with early-make auxiliary contacts
PKZM0-...+VHI-...-PKZ0

Additional product information (links)

IL03407010Z (AWA1210-2138) Motor-protective circuit-breaker

IL03407010Z (AWA1210-2138) Motor-protective circuit-breaker https://es-assets.eaton.com/DOCUMENTATION/AWA_INSTRUCTIONS/IL03407010Z2018_04.pdf

IL03402034Z (AWA121-1945) Motor-protective circuit-breaker, Starter

IL03402034Z (AWA121-1945) Motor-protective circuit-breaker, Starter https://es-assets.eaton.com/DOCUMENTATION/AWA_INSTRUCTIONS/IL03402034Z2018_06.pdf

Schaltvermögen https://de.ecat.eaton.com/flip-cat?edition=MOTCONT1_DE#page_3/44

Motor starters and "Special Purpose Ratings" for the North American market http://www.eaton.eu/ecm/groups/public/@pub/@europe/@electrical/documents/content/pct_3258146.pdf

Busbar Component Adapters for modern Industrial control panels http://www.moeller.net/binary/ver_techpapers/ver960en.pdf