

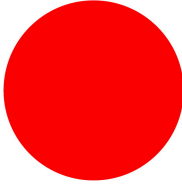



Pushbutton, Flat, momentary, 1 NC, Cable (black) with M8 plug, 4 pole, 0.2 m, red, Blank, Bezel: titanium

Part no. C22-D-R-K01-P30  
 Catalog No. 185693

**Delivery program**

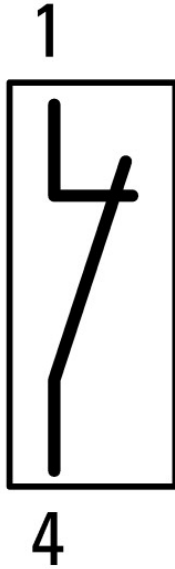
Product range			RMQ compact solution
Basic function			Pushbutton actuators
Single unit/Complete unit			Complete unit
Design			Flat momentary
Connection type			Cable (black) with M8 plug, 4 pole
Cable Length		m	0.2
<b>Button plate</b>			
button plate			red
Button plate			
			Blank
Name			None
Degree of Protection			IP66, IP67, IP69 (front) IP65 (on rear)
Front ring			Bezel: titanium
Connection to SmartWire-DT			no
<b>Contacts</b>			
N/C = Normally closed			1 NC 
Notes			 = safety function, by positive opening to IEC/EN 60947-5-1
<b>Actuator travel and actuation force as per DIN EN 60947-5-1, K.5.4.1</b>			
	mm		4.65
Maximum travel	mm		5.7
Minimum force for positive opening	N		15
Contact sequence			

Contact travel  = Contact closed  = Contact open

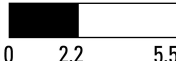
Contact diagram			
Positive opening (ZW)			yes

## Technical data

### General

Standards			IEC/EN 60947-5-1 VDE 0660
Certifications			CE, UL, CSA
Lifespan, mechanical	Operations	$\times 10^6$	> 1
Operating frequency	Operations/h		$\leq 3600$
Actuating force		n	$\leq 5$
Plug tightening torque		N/m	0.6
Tightening torque Threaded ring		Nm	2
Climatic proofing			Damp heat, constant, to IEC 60068-2-78 Damp heat, cyclic, to IEC 60068-2-30
Degree of Protection			IP66, IP67, IP69 (front) IP65 (on rear)
Ambient temperature			
Open		°C	-30 - +70
Storage		°C	-30 - +80
Mounting position			As required
Mechanical shock resistance, shock duration 11 ms		g	> 30

### Contacts

Rated impulse withstand voltage	$U_{imp}$	V AC	800
Rated insulation voltage	$U_i$	V	30
Overvoltage category/pollution degree			III/3
Control circuit reliability			
At 17 V DC/7 mA	$H_F$		N/C contact: statistically determined 1 failure per $0.9 \times 10^6$ Operations
Max. short-circuit protective device			
Fuse	gG/gL	A	4
Rated conditional short-circuit current	$I_q$	kA	1

### Switching capacity

Rated operational current	$I_e$	A	
AC-15			
24 V	$I_e$	A	4
DC-13			
24 V	$I_e$	A	3

### Cable characteristics

Design			M8
Cable Length		m	0.2
Material characteristic			PUR
Diameter	$\varnothing$	mm	4.7

## Design verification as per IEC/EN 61439

Technical data for design verification			
Operating ambient temperature min.		°C	-30
Operating ambient temperature max.		°C	70

## Technical data ETIM 7.0

Low-voltage industrial components (EG000017) / Push button, complete (EC001028)			
Electric engineering, automation, process control engineering / Low-voltage switch technology / Command and alarm device / Push-button actuator, complete unit (ecl@ss10.0.1-27-37-12-28 [AKF046014])			
Number of command positions			1

Type of button		Flat
Colour button		Red
Construction type lens		Round
Hole diameter	mm	22.5
Width opening	mm	0
Height opening	mm	0
Suitable for illumination		No
Switching function latching		No
Spring-return		Yes
Supply voltage lamp	V	0
Number of contacts as normally open contact		0
Number of contacts as normally closed contact		1
Number of contacts as change-over contact		0
Type of electric connection		Other
With front ring		Yes
Material front ring		Plastic
Colour front ring		Grey
Degree of protection (IP)		Other
Degree of protection (NEMA)		Other

## Approvals

Product Standards		IEC/EN 60947-5-1; UL 508; CAN/CSA-C22.2 No. 14-18 and No. 94.2-15; CE marking
UL File No.		E29184
UL Category Control No.		NKCR
CSA File No.		165628
CSA Class No.		321103
North America Certification		UL listed, CSA certified
Degree of Protection		2, 12

## Dimensions

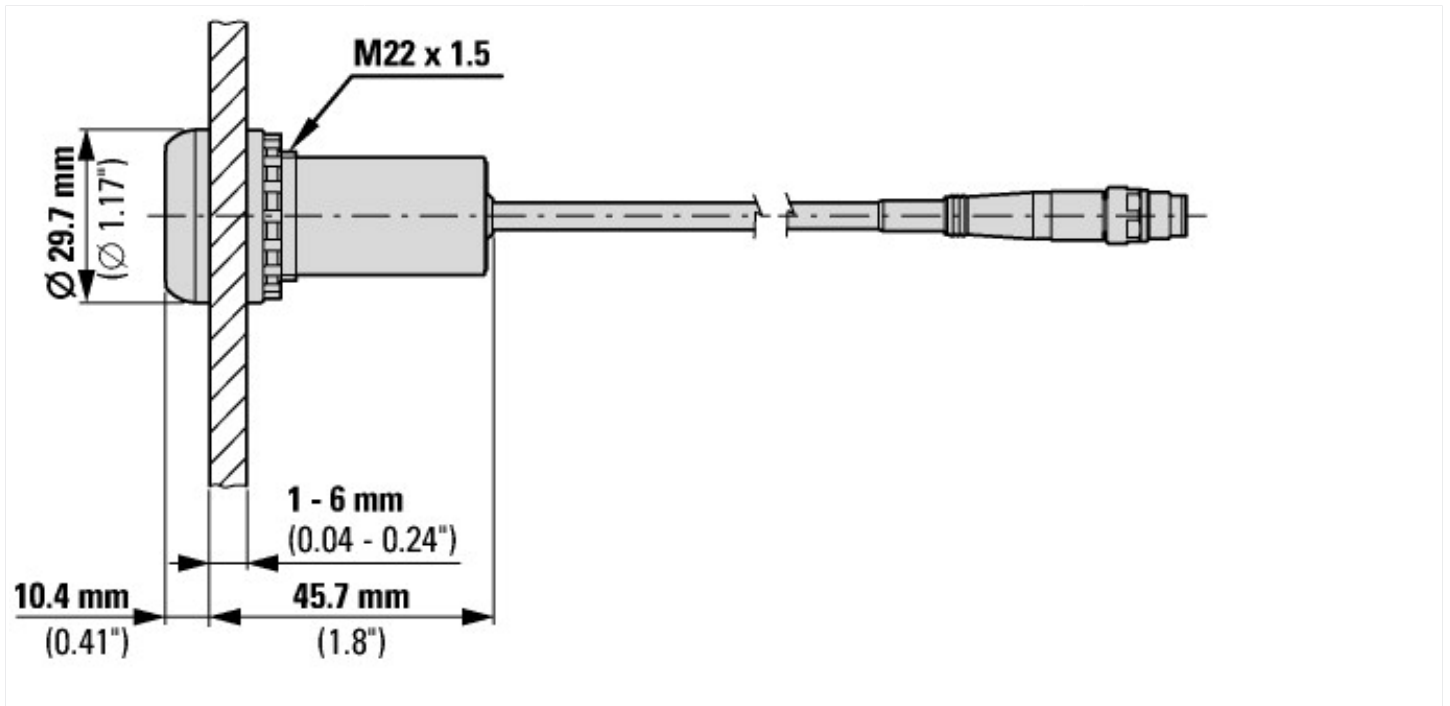

## Assets (links)

### Declaration of CE Conformity

00003256

### Instruction Leaflets

IL047016ZU2018\_06

## Additional product information (links)

### IL047016ZU RMQ compact solution

IL047016ZU RMQ compact solution

[ftp://ftp.moeller.net/DOCUMENTATION/AWA\\_INSTRUCTIONS/IL047016ZU2018\\_06.pdf](ftp://ftp.moeller.net/DOCUMENTATION/AWA_INSTRUCTIONS/IL047016ZU2018_06.pdf)