



Pushbutton, Flat, momentary, 1 N/O, Cable (black) with M8 plug, 4 pole, 0.5 m, Without button plate, Bezel: titanium

Part no. C22-D-X-K10-P31
 Catalog No. 185640

Delivery program

Product range			RMQ compact solution
Basic function			Pushbutton actuators
Single unit/Complete unit			Complete unit
Design			Flat momentary
Connection type			Cable (black) with M8 plug, 4 pole
Cable Length		m	0.5
Button plate			
button plate			Without button plate
Degree of Protection			IP66, IP67, IP69 (front) IP65 (on rear)
Front ring			Bezel: titanium
Connection to SmartWire-DT			no
Contacts			
N/O = Normally open			1 N/O
Contact sequence			
Contact travel = Contact closed = Contact open			
Contact diagram			

Technical data

General			
Standards			IEC/EN 60947-5-1 VDE 0660
Certifications			CE, UL, CSA
Lifespan, mechanical	Operations	x 10 ⁶	> 1
Operating frequency	Operations/h		≤ 3600
Actuating force	n		≤ 5
Plug tightening torque	N/m		0.6
Tightening torque Threaded ring	Nm		2

Climatic proofing			Damp heat, constant, to IEC 60068-2-78 Damp heat, cyclic, to IEC 60068-2-30
Degree of Protection			IP66, IP67, IP69 (front) IP65 (on rear)
Ambient temperature			
Open		°C	-30 - +70
Storage		°C	-30 - +80
Mounting position			As required
Mechanical shock resistance, shock duration 11 ms		g	> 30

Contacts

Rated impulse withstand voltage	U_{imp}	V AC	800
Rated insulation voltage	U_i	V	30
Overtoltage category/pollution degree			III/3
Control circuit reliability			
At 17 V DC/7 mA	H_F		N/O: 1 failure per 17×10^6 switching operations, statistically determined
Max. short-circuit protective device			
Fuse	gG/gL	A	4
Rated conditional short-circuit current	I_q	kA	1

Switching capacity

Rated operational current	I_e	A	
AC-15			
24 V	I_e	A	4
DC-13			
24 V	I_e	A	3

Cable characteristics

Design			M8
Cable Length		m	0.5
Material characteristic			PUR
Diameter	∅	mm	4.7

Design verification as per IEC/EN 61439

Technical data for design verification			
Operating ambient temperature min.		°C	-30
Operating ambient temperature max.		°C	70

Technical data ETIM 7.0

Low-voltage industrial components (EG000017) / Push button, complete (EC001028)			
Electric engineering, automation, process control engineering / Low-voltage switch technology / Command and alarm device / Push-button actuator, complete unit (ecl@ss10.0.1-27-37-12-28 [AKF046014])			
Number of command positions			1
Type of button			Flat
Colour button			Without button plate
Construction type lens			Round
Hole diameter		mm	22.5
Width opening		mm	0
Height opening		mm	0
Suitable for illumination			No
Switching function latching			No
Spring-return			Yes
Supply voltage lamp		V	0
Number of contacts as normally open contact			1
Number of contacts as normally closed contact			0
Number of contacts as change-over contact			0
Type of electric connection			Other
With front ring			Yes
Material front ring			Plastic

Colour front ring		Grey
Degree of protection (IP)		Other
Degree of protection (NEMA)		Other

Approvals

Product Standards		IEC/EN 60947-5-1; UL 508; CAN/CSA-C22.2 No. 14-18 and No. 94.2-15; CE marking
UL File No.		E29184
UL Category Control No.		NKCR
CSA File No.		165628
CSA Class No.		321103
North America Certification		UL listed, CSA certified
Degree of Protection		2, 12

Dimensions

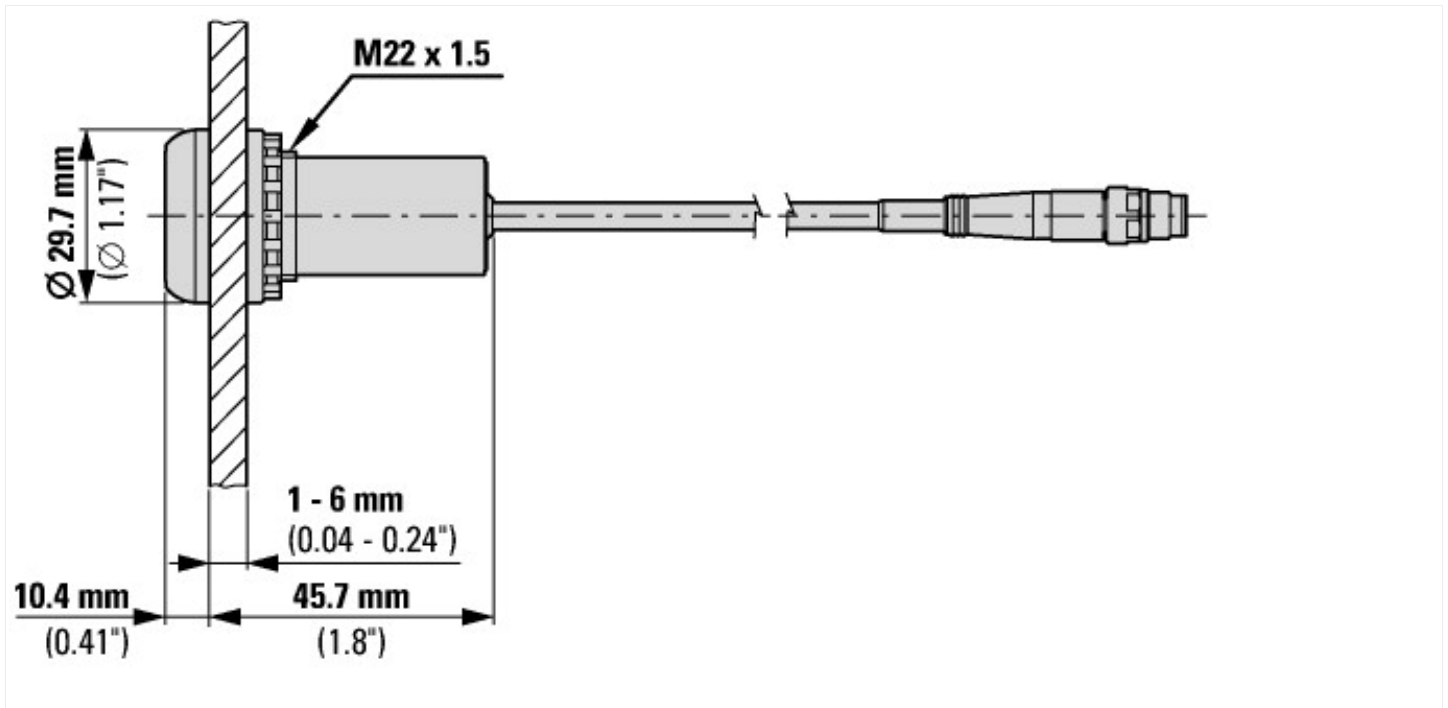

Assets (links)

Declaration of CE Conformity

00003256

Instruction Leaflets

IL047016ZU2018_06

Additional product information (links)

IL047016ZU RMQ compact solution

IL047016ZU RMQ compact solution ftp://ftp.moeller.net/DOCUMENTATION/AWA_INSTRUCTIONS/IL047016ZU2018_06.pdf