

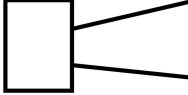

Acoustic module;230 V;continuous or pulsed tone;external actuation

Part no. **SL7-AP230-E**
 Catalog No. **171286**
 Alternate Catalog No. **SL7-AP230-E**
 EL-Nummer (Norway) **4137634**

Delivery program

Product range			SL signal towers
Basic function			Acoustic module
Degree of Protection			IP66
Rated operational voltage	U_e	V	230/240 V AC
Rated operational current	I_e	mA	43
Description			Continuous tone or pulsed tone, external actuation. Assigned two inputs (2 modules). Sound pressure 100 db, adjustable with internal potentiometer. $f = 2800$ Hz Place only at the highest position on a pole
Colour			
Function			
Connection to SmartWire-DT			no

Technical data

General			
Standards			IEC/EN 60947-5-1
Climatic proofing			Damp heat, cyclic, to IEC 60068-2-30
Mounting position			As required
Mechanical shock resistance		g	> 15 according to IEC 60068-2-27 Shock duration 11 ms Sinusoidal
IEC degree of protection			IP66 IEC/EN 60529
Protection type UL			Type 4, 4X, 13
Material			Enclosure: Polycarbonate (PC), black Cap: Polycarbonate (PC)
Ambient temperature		°C	-30 - +60
Weight		g	102

Contacts

Rated impulse withstand voltage	U_{imp}	V AC	4000
Rated insulation voltage	U_i	V	250
Overvoltage category/pollution degree			III/3

modules

Leakage current		A	< 0.003										
Type of tone			Continuous or pulsed tone										
Types of sound			2 versions, table of sound types										
Sound setting			can be externally actuated										
Table of sound types			Table of sound types										
			<table border="1"> <thead> <tr> <th>Sound type</th> <th>Frequency Diagram</th> <th>Repeat rate</th> <th>Special application</th> <th>Max. volume</th> </tr> </thead> <tbody> <tr> <td> </td> <td> </td> <td> </td> <td> </td> <td> </td> </tr> </tbody> </table>	Sound type	Frequency Diagram	Repeat rate	Special application	Max. volume					
Sound type	Frequency Diagram	Repeat rate	Special application	Max. volume									

			SL7-AP...-E	Hz	Continuous tone	approx. 2800	-	-	dB	100
					Pulsed tone	approx. 2800	approx. 2 Hz	-		100
Sound pressure				dB						100
Sound pressure level adjustment										Built-in, potentiometer
Sound_pressure_can_be_lowered_to_a_minimum_of										88 dB
Transmission angle										360°
Current-/power consumption										
at 230 /240V AC				A						0.043
Voltage range										230/240 V AC ± 10 %

Design verification as per IEC/EN 61439

Technical data for design verification										
Operating ambient temperature min.				°C						-30
Operating ambient temperature max.				°C						60

Technical data ETIM 7.0

Low-voltage industrial components (EG000017) / Acoustic module for signal tower (EC001261)										
Electric engineering, automation, process control engineering / Low-voltage switch technology / Command and alarm device / Signal column element, acoustic (ecl@ss10.0.1-27-37-12-37 [AKF055014])										
Function										Continuous tone/pulse tone
Outer diameter				mm						73
Colour										Black
Operating voltage at AC 50 Hz				V						230 - 240
Operating voltage at AC 60 Hz				V						230 - 240
Operating voltage at DC				V						0 - 0
Voltage type										AC
Tone adjustable										Yes
Degree of protection (IP)										IP66
Degree of protection (NEMA)										4X
Loudness				dB						100

Approvals

Product Standards										IEC/EN 60947-5-1; UL 508; CSA-C22.2 No. 14-10; CSA-C22.2 No. 94-91; CE marking
UL File No.										E29184
UL Category Control No.										NKCR
CSA File No.										UL report applies to both US and Canada
CSA Class No.										NKCR7
North America Certification										UL listed, certified by UL for use in Canada
Degree of Protection										UL Type 4, 4X, 13

Dimensions

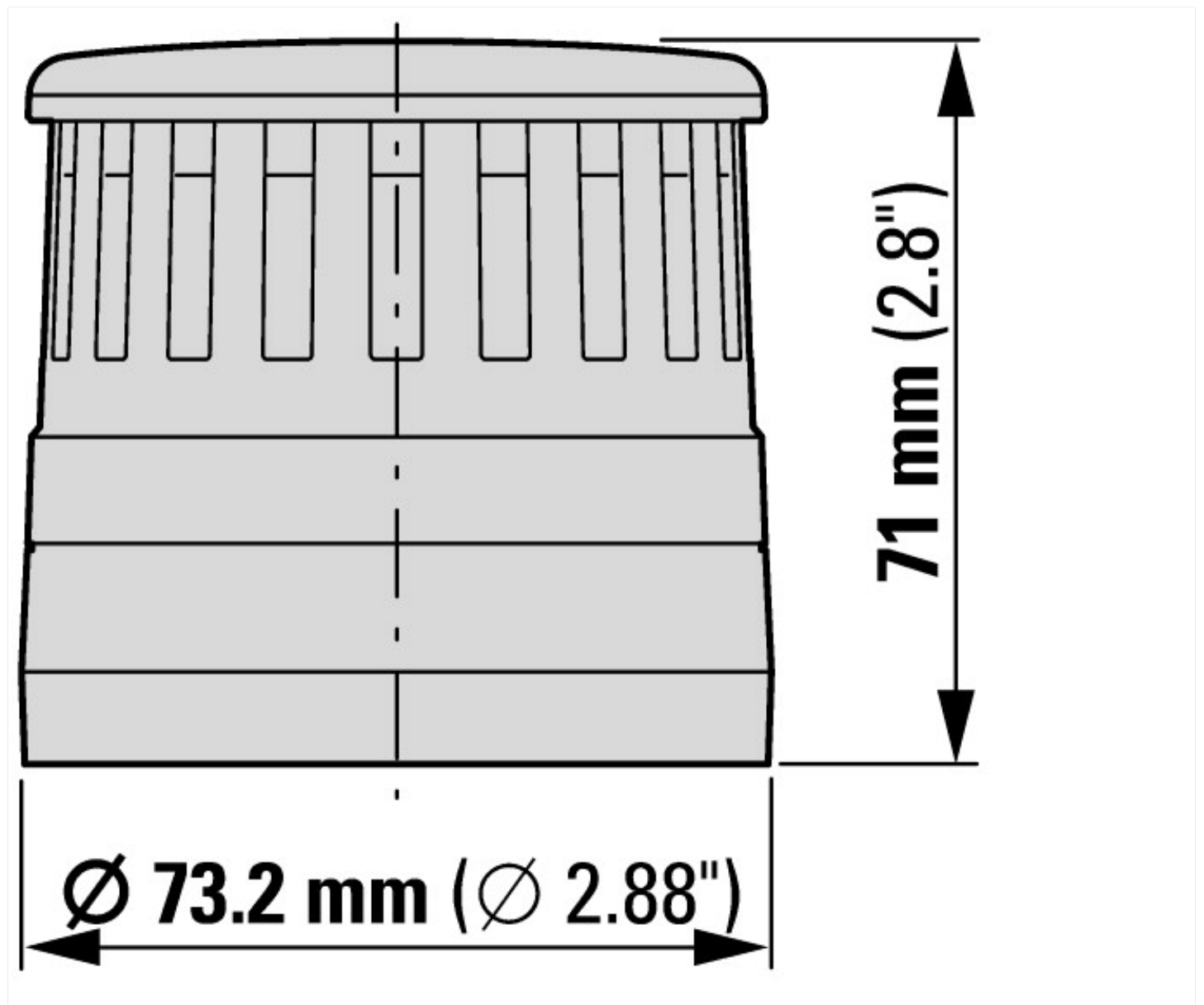

Assets (links)

Declaration of CE Conformity

00002899

Instruction Leaflets

IL047004ZU2018_05

Additional product information (links)

IL047004ZU SL7 Light Modules, Tone Modules

IL047004ZU SL7 Light Modules, Tone Modules ftp://ftp.moeller.net/DOCUMENTATION/AWA_INSTRUCTIONS/IL047004ZU2018_05.pdf